

SERIES: SWH15-N | **DESCRIPTION:** AC-DC POWER SUPPLY

FEATURES

- up to 15 W continuous power
- meets DoE Level VI efficiency
- universal input voltage range
- no load power consumption < 0.1 W
- over current and short circuit protections
- UL1310 compliant
- custom designs available



MODEL	output voltage	output current max	output power max	ripple and noise ¹ max	efficiency level
	(Vdc)	(A)	(W)	(mVp-p)	
SWH15-5-N	5	2.0	10.0	200	VI
SWH15-5B-N	5	3.0	15.0	200	VI
SWH15-9-N	9	1.5	13.5	200	VI
SWH15-12-N	12	1.0	12.0	200	VI
SWH15-24-N	24	0.6	14.4	200	VI

Notes: 1. At full load, nominal AC input voltage, 25°C, 20 MHz bandwidth oscilloscope, output terminated with 0.1 µF ceramic and 10 µF aluminum electrolytic capacitors.

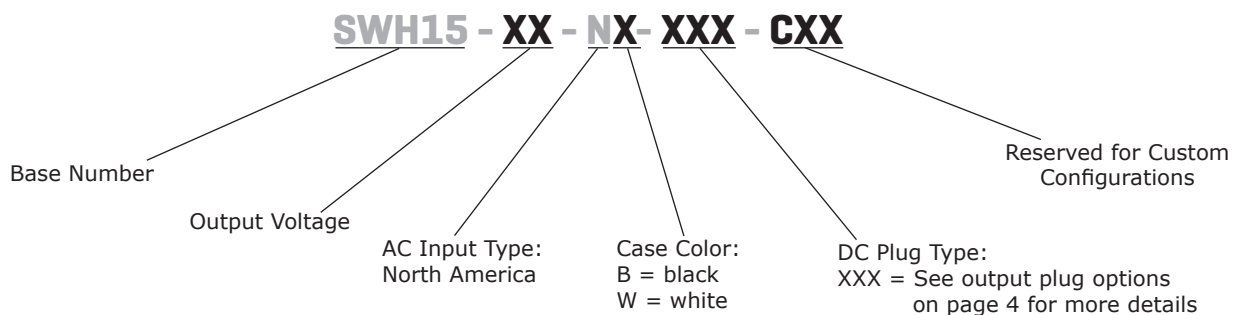
PART NUMBER KEY

INPUT

parameter	conditions/description	min	typ	max	units
voltage		90		264	Vac
frequency		47		63	Hz
current				0.5	A
leakage current	at 240 Vac, 50 Hz			0.25	mA
no load power consumption				0.1	W

OUTPUT

parameter	conditions/description	min	typ	max	units
line regulation			±1		%
load regulation	5 Vdc output	4.75		5.35	V
	9 Vdc output	8.55		9.5	V
	12 Vdc output	11.4		12.6	V
	24 Vdc output	22.8		25.2	V
start-up time	at 100 and 240 Vac, full load			3	s
hold-up time	at 115 Vac/60 Hz	1			ms
	at 230 Vac/50 Hz	3			ms

PROTECTIONS

parameter	conditions/description	min	typ	max	units
over current protection	auto recovery, hiccup				
short circuit protection	auto recovery				

SAFETY & COMPLIANCE

parameter	conditions/description	min	typ	max	units
isolation voltage	input to output at 10 mA for 1 minute		3,000		Vac
safety approvals	UL/cUL: 1310				
EMI/EMC	FCC Part 15 Class B				
MTBF	at full load, 25°C	50,000			hours
RoHS	yes				

ENVIRONMENTAL

parameter	conditions/description	min	typ	max	units
operating temperature		0		40	°C
storage temperature		-20		70	°C
operating humidity		10		95	%
storage humidity		5		95	%

MECHANICAL

parameter	conditions/description	min	typ	max	units
dimensions	62.04 x 39.66 x 33.22				mm
inlet plug	North America, 2 pin				
weight			80		g

MECHANICAL DRAWING

units: mm

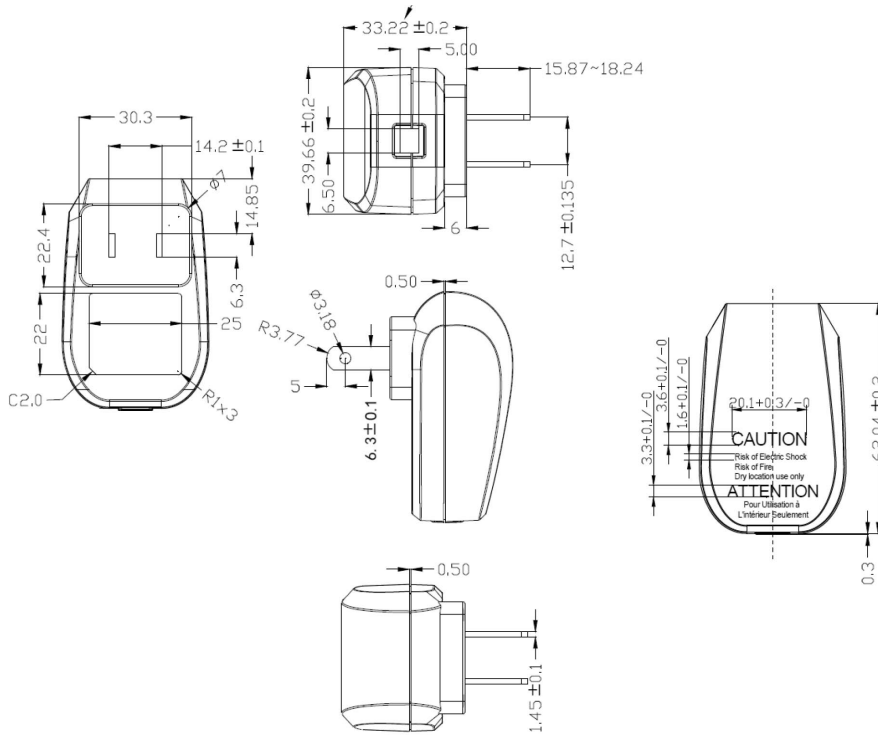

DC CORD

units: mm

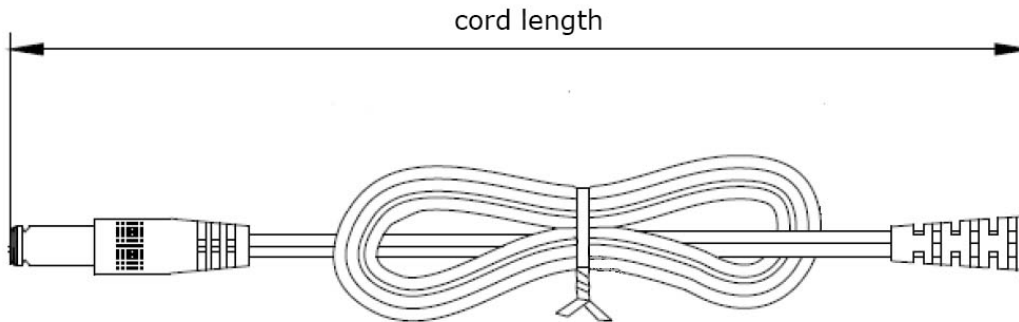



Table 1

MODEL NO.	CABLE	CORD LENGTH
SWH15-5-N	UL2468, 20 AWG	1,800 mm ±100
SWH15-5B-N	UL2468, 18 AWG	1,800 mm ±100
SWH15-9-N	UL2468, 20 AWG	1,800 mm ±100
SWH15-12-N	UL2468, 24 AWG	1,800 mm ±100
SWH15-24-N	UL2468, 24 AWG	1,800 mm ±100

DC PLUG TYPE PART NUMBER KEY

XXX

Plug Polarity:
 P = Center Positive

 N = Center Negative

Plug Code:
 X = Choose a code from the options below

Plug Angle:
 "blank" = Straight
 R = Right Angle

Plug Polarity		Code		Dimensions (mm)			Plug Angle	
Center Pos.	Center Neg.	Option	Type	A	B	C	Straight	Right
•	•	5	Standard	5.5	2.1	9.5	•	•
•	•	6	Standard	5.5	2.5	9.5	•	•
•	•	7	Standard	3.5	1.35	9.5	•	•
•	•	8	Standard	3.8	1.35	9.5	•	•
•	•	9	Standard	3.8	1.05	9.5	•	•
•	•	10	Locking	5.5	2.1	9.5	•	N/A
•	•	11	Locking	5.5	2.5	9.5	•	N/A
•	•	12	EIAJ-1	2.35	0.7	9.5	•	•
•	•	13	EIAJ-2	4.0	1.7	9.5	•	•
•	•	14	EIAJ-3	4.75	1.7	9.5	•	•
N/A	N/A	ST	Stripped & Tinned				N/A	N/A
N/A	N/A	MUB	USB	Micro USB Type B			•	N/A

Note: 1. Contact CUI for additional plug options

Standard

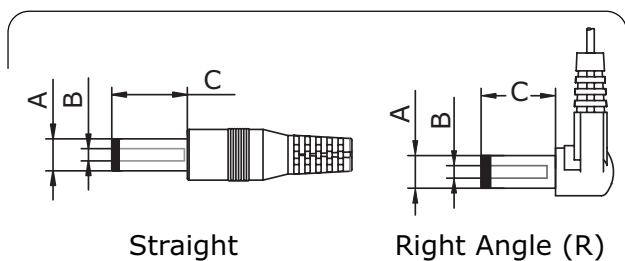

EIAJ

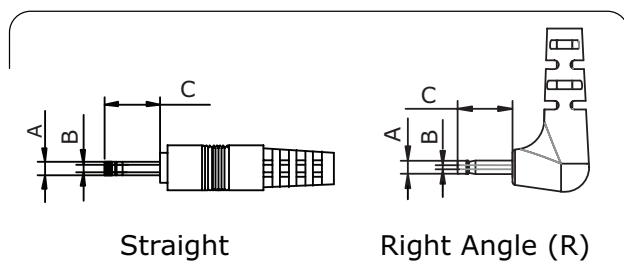

Locking

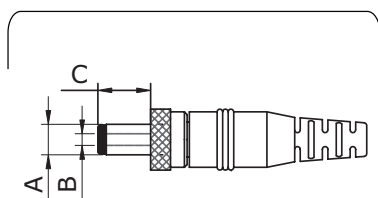

Stripped & Tinned

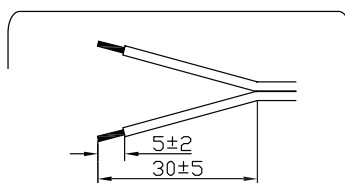

USB

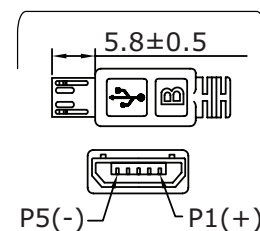

REVISION HISTORY

rev.	description	date
1.0	initial release	11/18/2021

The revision history provided is for informational purposes only and is believed to be accurate.



CUI INC

a bel group

Headquarters
20050 SW 112th Ave.
Tualatin, OR 97062
800.275.4899

Fax 503.612.2383
cui.com
techsupport@cui.com

This device complies with part 15 of the FCC Rules. Operation is subject to the following two conditions:

- (1) This device may not cause harmful interference, and
- (2) this device must accept any interference received, including interference that may cause undesired operation.

CUI offers a one (1) year limited warranty. Complete warranty information is listed on our website.

CUI reserves the right to make changes to the product at any time without notice. Information provided by CUI is believed to be accurate and reliable. However, no responsibility is assumed by CUI for its use, nor for any infringements of patents or other rights of third parties which may result from its use.

CUI products are not authorized or warranted for use as critical components in equipment that requires an extremely high level of reliability. A critical component is any component of a life support device or system whose failure to perform can be reasonably expected to cause the failure of the life support device or system, or to affect its safety or effectiveness.