

SUMMARY

Wires

Low voltage 6



Image is for illustrative purpose only

Series 2P
Termination type Female solder
IP rating 66
AWG wire size 28.00 - 20.00
Cable Ø 3.20 - 9.20 mm
Status active

Download

[Request a quote](#)

[Catalog](#)

TECHNICAL DETAILS

Mechanics

Shell Style/Model CN*: Fixed receptacle, nut fixing, watertight (IP 66)
Keying 3 keys (alpha=0, gamma=60; Plug: male contacts; Receptacle: female contacts)
Housing Material PSU (Polysulfone), gray
Weight 5.48 g

Performance

Configuration 2P.M06 : 6 Low V.
Insulator L: PEEK for solder contacts
Rated Current 12 Amps

Specifications

Contact Type: Solder
Contact Dia.: 1.3 mm (0.051in)
Bucket Dia.: 1.1 mm (0.043in)
Test voltage (kV rms) Contact-contact: 1.35
Air clearance min.: 1.2 mm
Creepage distance min.: 1.2 mm

Others

LEMO products and services are provided "as is". LEMO makes no warranties or representations with regard to LEMO product & services or use of them, express, implied or statutory, including for accuracy, completeness, or security. The user is fully responsible for his products and applications using LEMO components.

Endurance (Shell): >1000 mating cycles
 F ret (min): 150 N
 F ret (max): 250 N
 Steam sterilization: 20 times

DRAWINGS

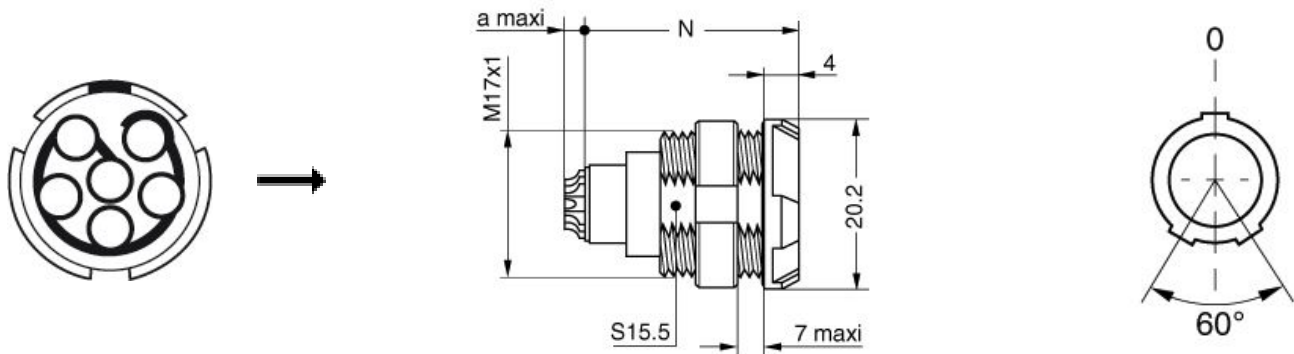

Dimensions

| | A | L | N |
|-----|------|------|------|
| mm. | 20.2 | 28.7 | 23.8 |
| in. | 0,80 | 1,13 | 0,94 |













RECOMMENDED BY LEMO

Tools

Cables

| | | | |
|--------------------|---------------|------|--|
| CMN.06.T20.062PGZE | | Grey | |
| CMN.06.T20.062PNZE | | | |
| CMN.06.T20.062QGZE | TPR (medical) | Grey | |
| CMN.06.T26.037QGZE | TPR (medical) | Grey | |

LEMO products and services are provided "as is". LEMO makes no warranties or representations with regard to LEMO product & services or use of them, express, implied or statutory, including for accuracy, completeness, or security. The user is fully responsible for his products and applications using LEMO components.

| | | | |
|--------------------|---------------|-------|---|
| CMN.06.T28.042QBCE | TPR (medical) | | |
| CMN.06.T28.044PGZE | | Grey |  |
| CMN.06.T28.044PNZE | | |  |
| 106220 | PVC | Black |  |
| 106240 | PTFE | White |  |
| 12080 | PVC | Grey | |
| 160140 | PVC | Grey |  |
| 160240 | PVC | Black |  |
| 160260 | PVC | Black |  |
| 260250 | PVC | Grey |  |
| 360500 | PVC | Grey |  |
| 360750 | PVC | Grey |  |
| 60260 | PTFE | White |  |
| 6280 | PVC | Black |  |

LEMO products and services are provided "as is". LEMO makes no warranties or representations with regard to LEMO product & services or use of them, express, implied or statutory, including for accuracy, completeness, or security. The user is fully responsible for his products and applications using LEMO components.