

PLEASE CHECK WWW.MOLEX.COM FOR LATEST PART INFORMATION

Part Number: **0541670208**
Status: **Active**
Overview: SlimStack™ 0.50mm Pitch Board-to-Board Connectors
Description: 0.50mm Pitch SlimStack Receptacle, Surface Mount, Dual Row, Vertical, 3.00 and 4.00mm Stacking Heights, Lower Circuit Size Version, Black, 20 Circuits

Documents:

3D Model	Product Specification PS-52991-008-001 (PDF)
Drawing (PDF)	Product Specification PS-54167-002-001 (PDF)
3D Model (PDF)	Product Specification PS-54167-003-001 (PDF)
Product Specification PS-52991-003-001 (PDF)	RoHS Certificate of Compliance (PDF)

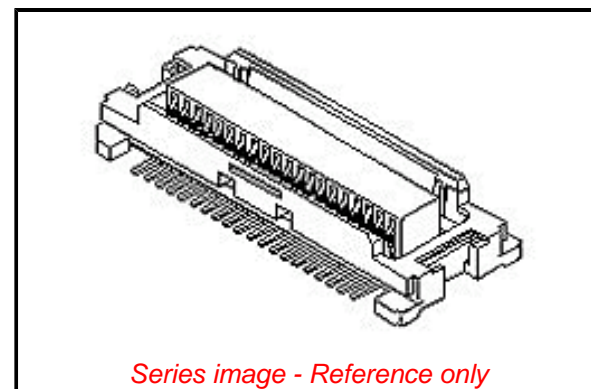

General

Product Family	PCB Receptacles
Series	54167
Application	Board-to-Board, Signal
Overview	SlimStack™ 0.50mm Pitch Board-to-Board Connectors
Product Name	SlimStack
UPC	800754250344

Physical

Circuits (Loaded)	20
Circuits (maximum)	20
Glow-Wire Capable	No
Mated Height	3.00mm, 4.00mm
Mated Width	5.40mm
Material - Plating Mating	Gold
Material - Plating Termination	Gold
Net Weight	92.000/mg
Number of Rows	2
Orientation	Vertical
PCB Locator	No
PCB Retention	None
PCB Thickness - Recommended	1.60mm
Packaging Type	Embossed Tape on Reel
Pitch - Mating Interface	0.50mm
Plating min - Mating	0.102µm
Plating min - Termination	0.254µm
Polarized to PCB	No
Surface Mount Compatible (SMC)	N/A
Temperature Range - Operating	-40° to +105°C
Termination Interface: Style	Surface Mount

Electrical

Current - Maximum per Contact	0.5A
Voltage - Maximum	50V

Material Info

Reference - Drawing Numbers

Product Specification	PS-52991-003-001, PS-52991-008-001, PS-54167-002-001, PS-54167-003-001
Sales Drawing	SD-54167-001-001, SD-54167-002-001

EU ELV

Not Relevant

EU RoHS

Compliant

REACH SVHC

Not Contained Per -
ECHA_01_2020 (16
January 2020

Halogen-Free

Status

Low-Halogen

For more information, please visit [Contact US](#)

China ROHS

ELV

RoHS Phthalates

China RoHS

Green Image

Not Relevant

Not Contained

Search Parts in this Series

54167 Series

Mates With

53916 , 53748 , 501920