



P-DUKE POWER

RCD15 Series

DC-DC Converter
Up to 15 Watts

3
YEARS
WARRANTY

ROHS
COMPLIANT

REACH
COMPLIANT



Automation



Datacom



IPC



Industry



Measurement



Telecom



Automobile



Boat



Charger



Medical



PV



Railway



3000
VDC
Isolation
Voltage

1600
VDC
Isolation
Voltage

2 : 1
Input
Range

6
sided
Shielding

Internal
EN55032
Class
A
Filter

LOW
Standby
Power

NO
Min. Load
Required

REMOTE
ON
OFF

OCP

OVP

SCP

UVP

PART NUMBER STRUCTURE

RCD15 -	48	S	05	H	-	M3	A	HC
Series Name	Input Voltage (VDC)	Output Quantity	Output Voltage (VDC)	Isolation Options		Operating Temp. Options	Remote ON/OFF & Trim Options	Assembly Options
	12:9~18 24:18~36 48:36~75	S:Single D: Dual	3P3:3.3 05:5 12:12 15:15 24:24 05:±5 12:±12 15:±15 24:±24	□: Standard type 1600VDC isolation H: 3000VDC isolation		□: -40°C~105°C M3: -55°C~105°C	□: Negative logic A: Positive logic B: Without Ctrl pin C: Negative logic without Trim pin D: Without Ctrl & Trim pin E: Positive logic without Trim pin	□: None HC: 7G-0047C-F; H=0.22" (※NRND) HC1: 7GA0117P01-F; H=0.3" HC2: 7GA0118P01-F; H=0.5" HC3: 7GA0119P01-F; H=0.8" ※NRND: Not recommended for new designs

TECHNICAL SPECIFICATION All specifications are typical at nominal input, full load and 25°C unless otherwise noted

Model Number	Input Range	Output Voltage	Output Current @Full Load	Input Current @No Load	Efficiency	Maximum Capacitor Load
	VDC	VDC	mA	mA	%	μF
RCD15-12S3P3	9 ~ 18	3.3	4500	8	88	5200
RCD15-12S05	9 ~ 18	5	3000	8	90	3600
RCD15-12S12	9 ~ 18	12	1300	8	89	600
RCD15-12S15	9 ~ 18	15	1000	10	90	500
RCD15-12S24	9 ~ 18	24	625	10	91	200
RCD15-12D05	9 ~ 18	±5	±1500	10	86	±1500
RCD15-12D12	9 ~ 18	±12	±625	10	90	±360
RCD15-12D15	9 ~ 18	±15	±500	14	90	±250
RCD15-12D24	9 ~ 18	±24	±315	14	90	±100
RCD15-24S3P3	18 ~ 36	3.3	4500	8	88	5200
RCD15-24S05	18 ~ 36	5	3000	8	90	3600
RCD15-24S12	18 ~ 36	12	1300	8	89	600
RCD15-24S15	18 ~ 36	15	1000	8	90	500
RCD15-24S24	18 ~ 36	24	625	8	91	200
RCD15-24D05	18 ~ 36	±5	±1500	8	86	±1500
RCD15-24D12	18 ~ 36	±12	±625	8	90	±360
RCD15-24D15	18 ~ 36	±15	±500	9	90	±250
RCD15-24D24	18 ~ 36	±24	±315	9	90	±100
RCD15-48S3P3	36 ~ 75	3.3	4500	7	87	5200
RCD15-48S05	36 ~ 75	5	3000	7	89	3600
RCD15-48S12	36 ~ 75	12	1300	7	89	600
RCD15-48S15	36 ~ 75	15	1000	7	89	500
RCD15-48S24	36 ~ 75	24	625	7	90	200
RCD15-48D05	36 ~ 75	±5	±1500	7	85	±1500
RCD15-48D12	36 ~ 75	±12	±625	7	89	±360
RCD15-48D15	36 ~ 75	±15	±500	7	89	±250
RCD15-48D24	36 ~ 75	±24	±315	7	89	±100

INPUT SPECIFICATIONS

Parameter	Conditions	Min.	Typ.	Max.	Unit	
Operating input voltage range	12Vin(nom)	9	12	18	VDC	
	24Vin(nom)	18	24	36		
	48Vin(nom)	36	48	75		
Start up voltage	12Vin(nom)			9	VDC	
	24Vin(nom)			18		
	48Vin(nom)			36		
Shutdown voltage	12Vin(nom)	7.5	8	8.8	VDC	
	24Vin(nom)	15.5	16	17.5		
	48Vin(nom)	32.5	33	35.5		
Start up time	Constant resistive load	Power up	30	40	ms	
		Remote ON/OFF	30	40		
Input surge voltage	1 second, max.	12Vin(nom)		25	VDC	
		24Vin(nom)		50		
		48Vin(nom)		100		
Input filter		Pi type				
Remote ON/OFF	Referred to -Vin pin	Positive logic DC-DC ON (Option)	Open or 3 ~ 15VDC			mA
		Negative logic DC-DC ON (Standard)	Short or 0 ~ 1.2VDC			
		Input current of Ctrl pin	-0.5	+1.0		
		Remote off input current	1.5			

OUTPUT SPECIFICATIONS						
Parameter	Conditions		Min.	Typ.	Max.	Unit
Voltage accuracy			-1.0		+1.0	%
Line regulation	Low Line to High Line at Full Load	Single Dual	-0.2 -0.5		+0.2 +0.5	%
Load regulation	No Load to Full Load	Single Dual	-0.2 -1.0		+0.2 +1.0	%
	10% Load to 90% Load	Single Dual	-0.1 -0.8		+0.1 +0.8	
Cross regulation	Asymmetrical load 25%/100% FL	Dual	-5.0		+5.0	%
Voltage adjustability	Single output	15Vout, 24Vout Others	-10 -10		+20 +10	%
Ripple and noise	20MHz bandwidth	Single 3.3Vout, 5Vout 12Vout, 15Vout 24Vout Dual 5Vout 12Vout, 15Vout 24Vout		75 100 125 75 100 125		mVp-p
Temperature coefficient			-0.02		+0.02	%/°C
Transient response recovery time	25% load step change			250		µs
Over voltage protection			3.3Vout 5Vout 12Vout 15Vout 24Vout		5.4 7.0 19.6 22.0 32.5	VDC
Over load protection	% of Iout rated		120	150	190	%
Short circuit protection			Continuous, automatic recovery			

GENERAL SPECIFICATIONS						
Parameter	Conditions		Min.	Typ.	Max.	Unit
Isolation voltage	1 minute	Input to Output Standard Type Suffix "H" Input (Output) to Case Standard Type Suffix "H"	1600 3000 1000 1600			VDC
Isolation resistance	500VDC		1			GΩ
Isolation capacitance					2000	pF
Switching frequency			220 270	245 300	270 330	kHz
		3.3Vout, 5Vout Others				
Safety approvals	IEC/ EN/ UL62368-1				UL:E193009 CB:UL(Demko)	
Case material					copper	
Base material					FR4 PCB	
Potting material					Silicone (UL94 V-0)	
Weight					16.5g (0.58oz)	
MTBF	MIL-HDBK-217F, Full load				1.672 x 10 ⁶ hrs	

ENVIRONMENTAL SPECIFICATIONS

Parameter	Conditions		Min.	Typ.	Max.	Unit
Operating ambient temperature	Standard type	With derating	-40		+105	°C
	M3 version	With derating	-55		+105	
Maximum case temperature					105	°C
Storage temperature range			-55		+125	°C
Thermal impedance	Natural convection	Without Heat-sink		17.0		°C/W
		With Heat-sink	HC	15.3		
			HC1	12.9		
			HC2	10.9		
			HC3	9.3		
Thermal shock						MIL-STD-810F
Shock						MIL-STD-810F
Vibration						MIL-STD-810F
Relative humidity						5% to 95% RH

EMC SPECIFICATIONS

Parameter	Conditions		Level
EMI	EN55032	Without external components	Class A
		With external components	Class B
EMS	EN55035		
ESD	EN61000-4-2	Air ± 8kV and Contact ± 6kV	Perf. Criteria A
Radiated immunity	EN61000-4-3	10 V/m	Perf. Criteria A
Fast transient	EN61000-4-4	±2kV	Perf. Criteria A
		RCD15-12□□□□	With an aluminum electrolytic capacitor (Nippon chemi-con KY series, 470µF/50V) and a TVS (SMDJ58A, 58V, 3000Watt peak pulse power) in parallel
		RCD15-24□□□□	With an aluminum electrolytic capacitor (Nippon chemi-con KY series, 470µF/50V) and a TVS (SMDJ70A, 70V, 3000Watt peak pulse power) in parallel
		RCD15-48□□□□	With an aluminum electrolytic capacitor (Nippon chemi-con KY series, 220µF/100V) and a TVS (SMDJ100A, 100V, 3000Watt peak pulse power) in parallel
Surge	EN61000-4-5	±2kV	Perf. Criteria A
		RCD15-12□□□□	With an aluminum electrolytic capacitor (Nippon chemi-con KY series, 470µF/50V) and a TVS (SMDJ58A, 58V, 3000Watt peak pulse power) in parallel
		RCD15-24□□□□	With an aluminum electrolytic capacitor (Nippon chemi-con KY series, 470µF/50V) and a TVS (SMDJ70A, 70V, 3000Watt peak pulse power) in parallel
		RCD15-48□□□□	With an aluminum electrolytic capacitor (Nippon chemi-con KY series, 220µF/100V) and a TVS (SMDJ100A, 100V, 3000Watt peak pulse power) in parallel
Conducted immunity	EN61000-4-6	10 Vr.m.s	Perf. Criteria A
Power frequency magnetic field	EN61000-4-8	100A/m continuous; 1000A/m 1 second	Perf. Criteria A

CAUTION: This power module is not internally fused. An input line fuse must always be used.

CHARACTERISTIC CURVE

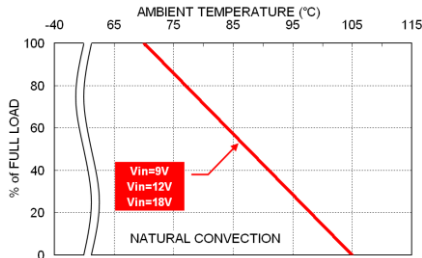

RCD15-12 Derating Curve

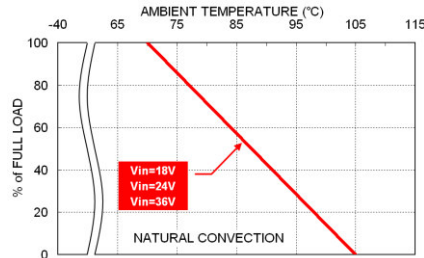

RCD15-24 Derating Curve

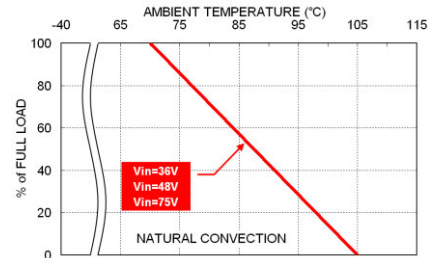

RCD15-48 Derating Curve

*Except for RCD15-□□□□D05

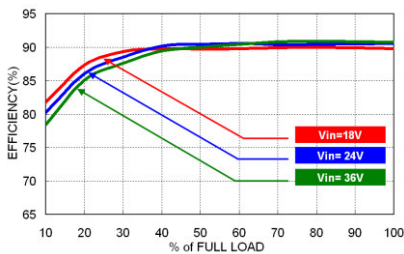

RCD15-24S05 Efficiency vs. Output Load

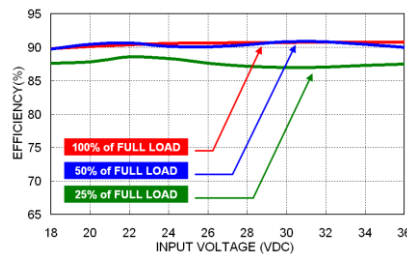

RCD15-24S05 Efficiency vs. Input Voltage

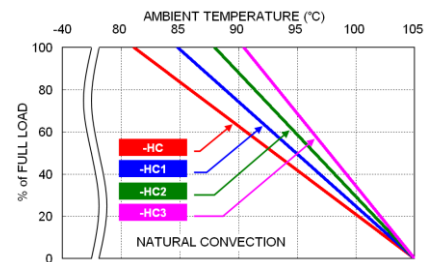

RCD15-24S05 Derating Curve With Heat-sink

FUSE CONSIDERATION

This power module is not internally fused. An input line fuse must always be used.

This encapsulated power module can be used in a wide variety of applications, ranging from simple stand-alone operation to an integrated part of sophisticated power architecture.

To maximum flexibility, internal fusing is not included; however, to achieve maximum safety and system protection, always use an input line fuse.

The input line fuse suggest as below :

Modules	Fuse Rating (A)	Fuse Type
RCD15-12S□□、RCD15-12D□□	3.15	Slow-Blow
RCD15-24S□□、RCD15-24D□□	1.6	Slow-Blow
RCD15-48S□□、RCD15-48D□□	0.8	Slow-Blow

The table based on the information provided in this data sheet on inrush energy and maximum DC input current at low Vin..

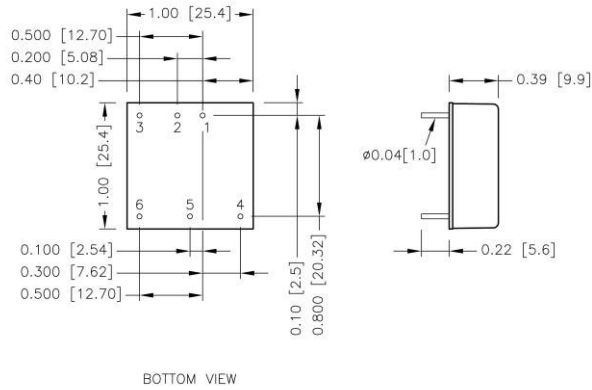
MECHANICAL DRAWING

PIN CONNECTION

PIN	SINGLE	DUAL
1	+Vin	+Vin
2	-Vin	-Vin
3	Ctrl	Ctrl
4	+Vout	+Vout
5	Trim	Common
6	-Vout	-Vout

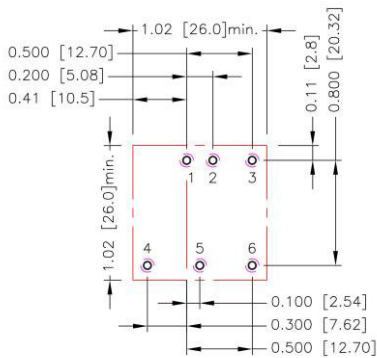
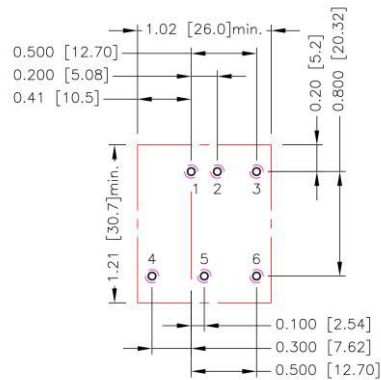
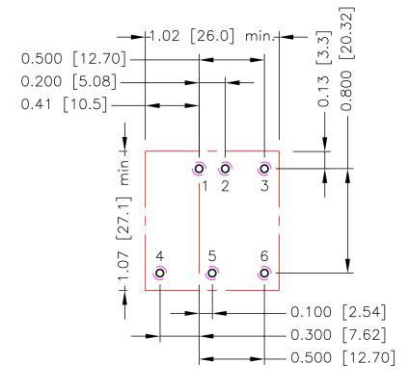
- All dimensions in inch [mm]
Tolerance :x.xx±0.02 [x.x±0.5]
x.xxx±0.010 [x.xx±0.25]
- Pin dimension tolerance ±0.004[0.10]

RECOMMENDED PAD LAYOUT
Standard

-HC

-HC1 、 -HC2 、 -HC3

All dimensions in inch[mm]
 Pad size(lead free recommended)
 Through hole 1.2.3.4.5.6: $\Phi 0.051[1.30]$
 Top view pad 1.2.3.4.5.6: $\Phi 0.064[1.63]$
 Bottom view pad 1.2.3.4.5.6: $\Phi 0.102[2.60]$

THERMAL CONSIDERATIONS

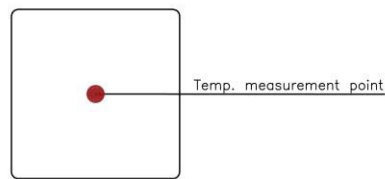
The power module operates in a variety of thermal environments. However, sufficient cooling should be provided to help ensure reliable operation of the unit. Heat is removed by conduction, convection, and radiation to the surrounding environment. Proper cooling can be verified by measuring the point as the figure below. The temperature at this location should not exceed "Maximum case temperature". When operating, adequate cooling must be provided to maintain the test point temperature at or below "Maximum case temperature". You can limit this temperature to a lower value for extremely high reliability.

- Thermal test condition with vertical direction by natural convection (20LFM).



TOP VIEW

HEAT-SINK TYPE OPTIONS

RCD15-□□□□□-**HC**
7G-0047C-F

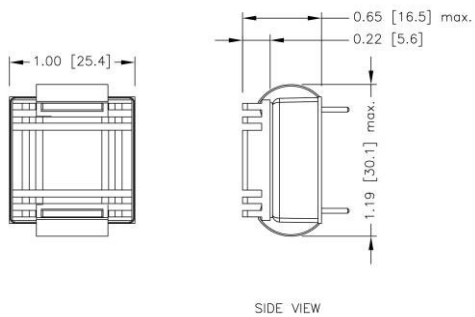

RCD15-□□□□□-**HC1**
7GA0117P01-F

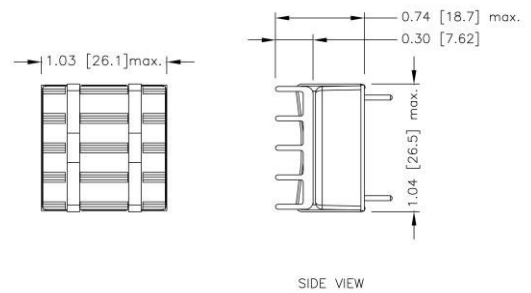

RCD15-□□□□□-**HC2**
7GA0118P01-F

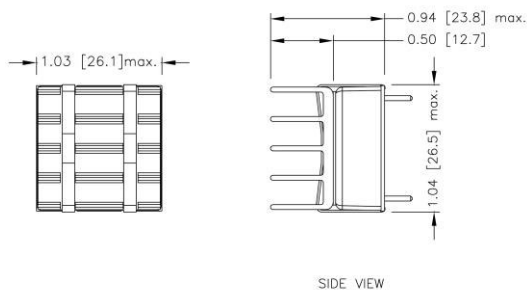

RCD15-□□□□□-**HC3**
7GA0119P01-F

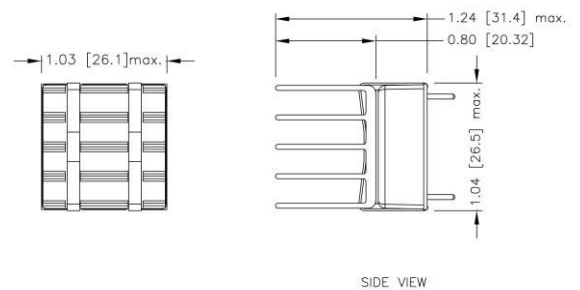

- All dimensions in inch [mm]
- Tolerance : x.xx±0.02 [x.x±0.5]
x.xxx±0.010 [x.xx±0.25]

OUTPUT VOLTAGE ADJUSTMENT

Output voltage set point adjustment allows the user to increase or decrease the output voltage set point of the module. This is accomplished by connecting an external resistor between the Trim pin and either the +Output or -Output pins. With an external resistor between the Trim and -Output pin, the output voltage set point increases. With an external resistor between the Trim and +Output pin, the output voltage set point decreases. The external Trim resistor needs to be at least 1/16W of rated power.

Trim Up Equation

$$R_U = \left[\frac{G \times L}{(V_{o,up} - L - K)} - H \right] \Omega$$

Trim Down Equation

$$R_D = \left[\frac{(V_{o,down} - L) \times G}{(V_o - V_{o,down})} - H \right] \Omega$$

Trim Constants

Module	G	H	K	L
RCD15-□□S3P3	5110	2050	0.8	2.5
RCD15-□□S05	5110	2050	2.5	2.5
RCD15-□□S12	10000	5110	9.5	2.5
RCD15-□□S15	10000	5110	12.5	2.5
RCD15-□□S24	56000	13000	21.5	2.5

EXTERNAL OUTPUT TRIMMING

Output can be externally trimmed by using the method shown below.

Trim-up

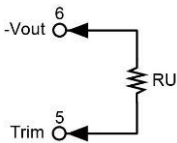

□□S3P3

ΔV (%)	1	2	3	4	5	6	7	8	9	10
Vout (V)	3.333	3.366	3.399	3.432	3.465	3.498	3.531	3.564	3.597	3.630
RU (kΩ)	385.071	191.511	126.990	94.730	75.374	62.470	53.253	46.340	40.963	36.662

□□S05

ΔV (%)	1	2	3	4	5	6	7	8	9	10
Vout (V)	5.050	5.100	5.150	5.200	5.250	5.300	5.350	5.400	5.450	5.500
RU (kΩ)	253.450	125.700	83.117	61.825	49.050	40.533	34.450	29.888	26.339	23.500

□□S12

ΔV (%)	1	2	3	4	5	6	7	8	9	10
Vout (V)	12.120	12.240	12.360	12.480	12.600	12.720	12.840	12.960	13.080	13.200
RU (kΩ)	203.223	99.057	64.334	46.973	36.557	29.612	24.652	20.932	18.038	15.723

□□S15

ΔV (%)	1	2	3	4	5	6	7	8	9	10
Vout (V)	15.150	15.300	15.450	15.600	15.750	15.900	16.050	16.200	16.350	16.500
RU (kΩ)	161.557	78.223	50.446	36.557	28.223	22.668	18.700	15.723	13.409	11.557

ΔV (%)	11	12	13	14	15	16	17	18	19	20
Vout (V)	16.650	16.800	16.950	17.100	17.250	17.400	17.550	17.700	17.850	18.000
RU (kΩ)	10.042	8.779	7.711	6.795	6.001	5.307	4.694	4.149	3.662	3.223

□□S24

ΔV (%)	1	2	3	4	5	6	7	8	9	10
Vout (V)	24.240	24.480	24.720	24.960	25.200	25.440	25.680	25.920	26.160	26.400
RU (kΩ)	570.333	278.667	181.444	132.833	103.667	84.222	70.333	59.917	51.815	45.333

ΔV (%)	11	12	13	14	15	16	17	18	19	20
Vout (V)	26.640	26.880	27.120	27.360	27.600	27.840	28.080	28.320	28.560	28.800
RU (kΩ)	40.030	35.611	31.872	28.667	25.889	23.458	21.314	19.407	17.702	16.167

OUTPUT VOLTAGE ADJUSTMENT(CONTINUED)

Trim-down

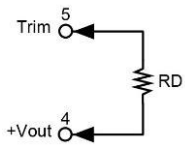

□□S3P3

ΔV (%)	1	2	3	4	5	6	7	8	9	10
Vout (V)	3.267	3.234	3.201	3.168	3.135	3.102	3.069	3.036	3.003	2.970
RD (k Ω)	116.719	54.779	34.133	23.810	17.616	13.486	10.537	8.325	6.604	5.228

□□S05

ΔV (%)	1	2	3	4	5	6	7	8	9	10
Vout (V)	4.950	4.900	4.850	4.800	4.750	4.700	4.650	4.600	4.550	4.500
RD (k Ω)	248.340	120.590	78.007	56.715	43.940	35.423	29.340	24.778	21.229	18.390

□□S12

ΔV (%)	1	2	3	4	5	6	7	8	9	10
Vout (V)	11.880	11.760	11.640	11.520	11.400	11.280	11.160	11.040	10.920	10.800
RD (k Ω)	776.557	380.723	248.779	182.807	143.223	116.834	97.985	83.848	72.853	64.057

□□S15

ΔV (%)	1	2	3	4	5	6	7	8	9	10
Vout (V)	14.850	14.700	14.550	14.400	14.250	14.100	13.950	13.800	13.650	13.500
RD (k Ω)	818.223	401.557	262.668	193.223	151.557	123.779	103.938	89.057	77.483	68.223

□□S24

ΔV (%)	1	2	3	4	5	6	7	8	9	10
Vout (V)	23.760	23.520	23.280	23.040	22.800	22.560	22.320	22.080	21.840	21.600
RD (k Ω)	4947.667	2439.333	1603.222	1185.167	934.333	767.111	647.667	558.083	488.407	432.667



P-DUKE Technology Co., Ltd.

Tel +886-4-2359-0668
 Fax +886-4-2359-1337
 Email sales@pduke.com
 Web www.pduke.com
 Add No. 36, 22nd Rd., Taichung Industrial Park,
 Taichung, Taiwan, R.O.C.