

## Varistors (ZNR Surge Absorber)

### E type



Varistors (ZNR Surge Absorber) Type E is capable of handling larger surge energy than Type D in applications to protect electronic equipment or semiconductor devices from switching and induced lightning surges.

### Features

- UL and CSA recognized components
- Very large surge withstanding capability with a compact size
- Direct mounting on boards like a power distribution board available
- Fast response to steep impulse voltage
- Low clamping voltage for better surge protection
- RoHS compliant

### Recommended applications

- Transistor, diode, IC, thyristor or triac semiconductor protection
- Surge protection in industrial power plant operations
- Relay or electromagnetic valve surge absorption
- Surge absorption applications in broadcasting, communications devices, traffic/railroad, agricultural facilities, waterworks
- Surge protection of automatic control devices for power distribution line

### Related standards

Standard No.	UL1449	CSA C22.2 No.269.5
Title	Surge protective devices	Surge protective devices - Type 5 – Components

- Each type designation is not registered by Part Number.

Note : Ask our factory for Product Specification before use.

- As for handling precautions and minimum quantity / Packing unit please see related information.

### Explanation of part numbers

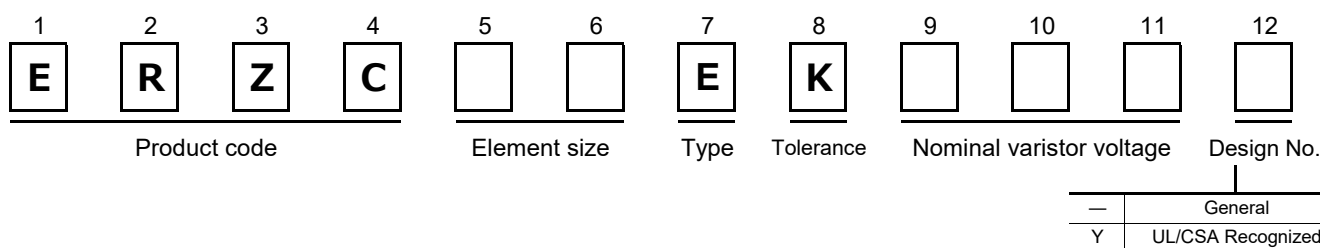

### Dimensions in mm (not to scale)

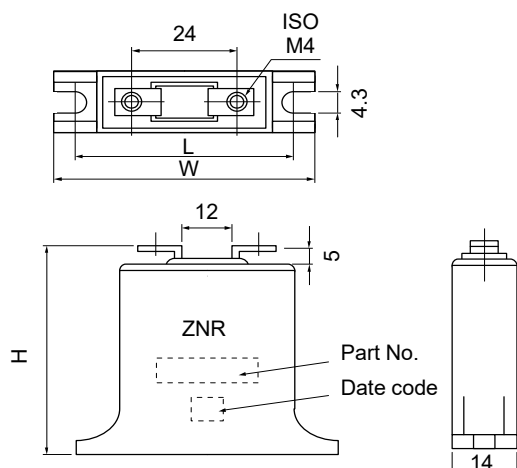

Unit : mm

Part No.	W	H	L
ERZC20EK□□□(Y)	48±1	42±1	39±1
ERZC32EK□□□(Y)	60±1	55±1	51±1

## E type / 20, 32 series (UL and CSA Recognized)

### Ratings and characteristics (20 series)

● Operating temperature range : -40 to 85 °C

● Storage temperature range : -40 to 110 °C

Part No. (UL/CSA Recognized)	Type designation	Varistor voltage at 1 mA	Maximum allowable voltage		Maximum clamping voltage at 100 A	Maximum energy (2ms)  1 time	Maximum peak current  (8/20μs)	Rated voltage (UL/CSA)
			(V)	Acrms (V)			DC (V)	
		ACrms (V)						
ERZC20EK201Y	20EK201U	200 (185 to 225)	130	170	340	80	8000	118
ERZC20EK241Y	20EK241U	240 (216 to 264)	150	200	395	95	8000	136
ERZC20EK271Y	20EK271U	270 (247 to 303)	175	225	455	100	8000	159
ERZC20EK361Y	20EK361U	360 (324 to 396)	230	300	595	120	8000	209
ERZC20EK391Y	20EK391U	390 (351 to 429)	250	320	650	130	8000	227
ERZC20EK431Y	20EK431U	430 (387 to 473)	275	350	710	140	8000	250
ERZC20EK471Y	20EK471U	470 (423 to 517)	300	385	775	150	8000	272
ERZC20EK511Y	20EK511U	510 (459 to 561)	320	415	845	150	8000	291
ERZC20EK621Y	20EK621U	620 (558 to 682)	385	505	1025	160	8000	350
ERZC20EK681Y	20EK681U	680 (612 to 748)	420	560	1120	175	8000	381
ERZC20EK751Y	20EK751U	750 (675 to 825)	460	615	1240	190	8000	418
ERZC20EK781Y	20EK781U	780 (702 to 858)	485	640	1290	200	8000	440
ERZC20EK821Y	20EK821U	820 (738 to 902)	510	670	1355	215	8000	463
ERZC20EK911Y	20EK911U	910 (819 to 1001)	550	745	1500	240	8000	500
ERZC20EK102Y	20EK102U	1000 (900 to 1100)	625	825	1650	245	8000	568
ERZC20EK112Y	20EK112U	1100 (990 to 1210)	680	895	1815	250	8000	600

### Ratings and characteristics (32 series)

● Operating temperature range : -40 to 85 °C

● Storage temperature range : -40 to 110 °C

Part No. (UL/CSA Recognized)	Type designation	Varistor voltage at 1 mA	Maximum allowable voltage		Maximum clamping voltage at 200 A	Maximum energy (2ms)  1 time	Maximum peak current  (8/20μs)	Rated voltage (UL/CSA)
			(V)	Acrms (V)			DC (V)	
		ACrms (V)						
ERZC32EK201Y	32EK201U	200 (185 to 225)	130	170	340	210	25000	118
ERZC32EK241Y	32EK241U	240 (216 to 264)	150	200	395	240	25000	136
ERZC32EK271Y	32EK271U	270 (247 to 303)	175	225	455	255	25000	159
ERZC32EK361Y	32EK361U	360 (324 to 396)	230	300	595	325	25000	209
ERZC32EK391Y	32EK391U	390 (351 to 429)	250	320	650	350	25000	227
ERZC32EK431Y	32EK431U	430 (387 to 473)	275	350	710	400	25000	250
ERZC32EK471Y	32EK471U	470 (423 to 517)	300	385	775	405	25000	272
ERZC32EK511Y	32EK511U	510 (459 to 561)	320	415	845	405	25000	291
ERZC32EK621Y	32EK621U	620 (558 to 682)	385	505	1025	415	25000	350
ERZC32EK681Y	32EK681U	680 (612 to 748)	420	560	1120	450	25000	381
ERZC32EK751Y	32EK751U	750 (675 to 825)	460	615	1240	500	25000	418
ERZC32EK781Y	32EK781U	780 (702 to 858)	485	640	1290	520	25000	440
ERZC32EK821Y	32EK821U	820 (738 to 902)	510	670	1355	545	25000	463
ERZC32EK911Y	32EK911U	910 (819 to 1001)	550	745	1500	600	25000	500
ERZC32EK102Y	32EK102U	1000 (900 to 1100)	625	825	1650	620	25000	568
ERZC32EK112Y	32EK112U	1100 (990 to 1210)	680	895	1815	640	25000	600

## Ratings and characteristics (20 series)

● Operating temperature range : -40 to 85 °C

● Storage temperature range : -40 to 110 °C

Part No.	Varistor voltage at 1 mA (V)	Maximum allowable voltage		Maximum clamping voltage at 100 A (V)	Rated power (W)	Maximum energy (2ms) (J)	Maximum peak current (8/20 μs)		Typical capacitance (Reference) at 1 kHz (pF)
		Acrms (V)	DC (V)				1 time (A)	2 times (A)	
ERZC20EK201	200 (185 to 225)	130	170	340	0.8	80	8000	5000	2300
ERZC20EK241	240 (216 to 264)	150	200	395	0.8	95	8000	5000	1500
ERZC20EK271	270 (247 to 303)	175	225	455	0.8	100	8000	5000	1400
ERZC20EK361	360 (324 to 396)	230	300	595	0.8	120	8000	5000	1300
ERZC20EK391	390 (351 to 429)	250	320	650	0.8	130	8000	5000	1200
ERZC20EK431	430 (387 to 473)	275	350	710	0.8	140	8000	5000	1000
ERZC20EK471	470 (423 to 517)	300	385	775	0.8	150	8000	5000	950
ERZC20EK511	510 (459 to 561)	320	415	845	0.8	150	8000	5000	930
ERZC20EK621	620 (558 to 682)	385	505	1025	0.8	160	8000	5000	900
ERZC20EK681	680 (612 to 748)	420	560	1120	0.8	175	8000	5000	850
ERZC20EK751	750 (675 to 825)	460	615	1240	0.8	190	8000	5000	800
ERZC20EK781	780 (702 to 858)	485	640	1290	0.8	200	8000	5000	800
ERZC20EK821	820 (738 to 902)	510	670	1355	0.8	215	8000	5000	700
ERZC20EK911	910 (819 to 1001)	550	745	1500	0.8	240	8000	5000	700
ERZC20EK102	1000 (900 to 1100)	625	825	1650	0.8	245	8000	5000	400
ERZC20EK112	1100 (990 to 1210)	680	895	1815	0.8	250	8000	5000	350

## Ratings and characteristics (32 series)

● Operating temperature range : -40 to 85 °C

● Storage temperature range : -40 to 110 °C

Part No.	Varistor voltage at 1 mA (V)	Maximum allowable voltage		Maximum clamping voltage at 200 A (V)	Rated power (W)	Maximum energy (2ms) (J)	Maximum peak current (8/20 μs)		Typical capacitance (Reference) at 1 kHz (pF)
		Acrms (V)	DC (V)				1 time (A)	2 times (A)	
ERZC32EK201	200 (185 to 225)	130	170	340	1.2	210	25000	20000	5500
ERZC32EK241	240 (216 to 264)	150	200	395	1.2	240	25000	20000	5000
ERZC32EK271	270 (247 to 303)	175	225	455	1.2	255	25000	20000	4200
ERZC32EK361	360 (324 to 396)	230	300	595	1.2	325	25000	20000	3500
ERZC32EK391	390 (351 to 429)	250	320	650	1.2	350	25000	20000	3000
ERZC32EK431	430 (387 to 473)	275	350	710	1.2	400	25000	20000	2500
ERZC32EK471	470 (423 to 517)	300	385	775	1.2	405	25000	20000	2500
ERZC32EK511	510 (459 to 561)	320	415	845	1.2	405	25000	20000	2400
ERZC32EK621	620 (558 to 682)	385	505	1025	1.2	415	25000	20000	2200
ERZC32EK681	680 (612 to 748)	420	560	1120	1.2	450	25000	20000	2100
ERZC32EK751	750 (675 to 825)	460	615	1240	1.2	500	25000	20000	2000
ERZC32EK781	780 (702 to 858)	485	640	1290	1.2	520	25000	20000	1900
ERZC32EK821	820 (738 to 902)	510	670	1355	1.2	545	25000	20000	1800
ERZC32EK911	910 (819 to 1001)	550	745	1500	1.2	600	25000	20000	1700
ERZC32EK102	1000 (900 to 1100)	625	825	1650	1.2	620	25000	20000	1000
ERZC32EK112	1100 (990 to 1210)	680	895	1815	1.2	640	25000	20000	800

Typical characteristics

Voltage vs. Current

(ERZC20EK201(Y) to ERZC20EK511(Y))

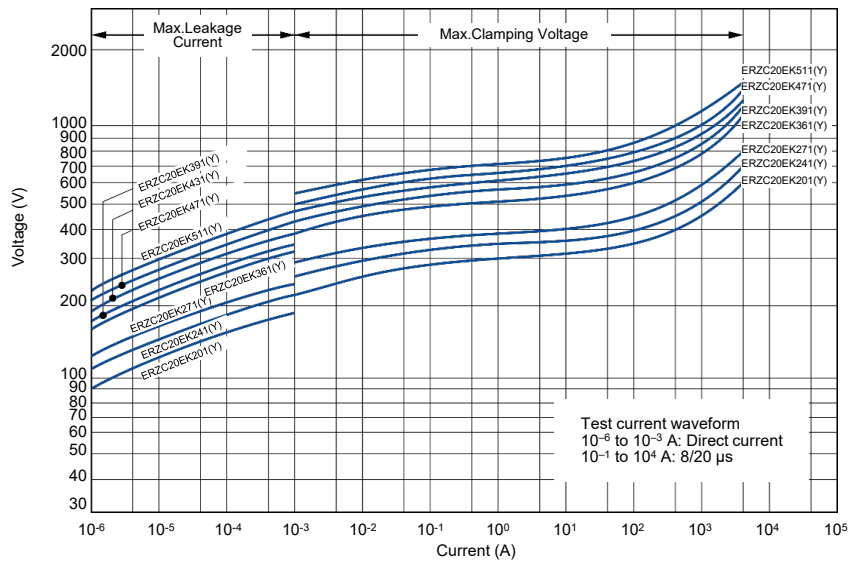

(ERZC20EK621(Y) to ERZC20EK112(Y))

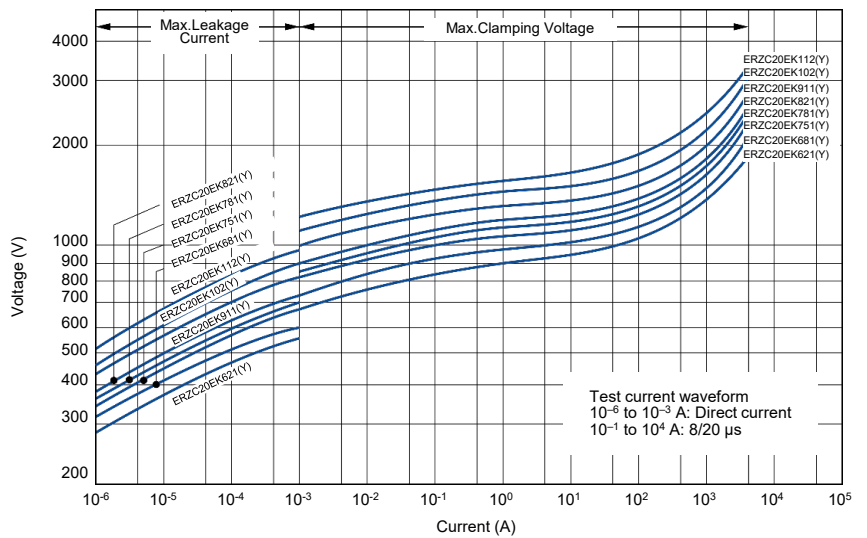

Impulse derating curve (Relation between impulse width and surge, repetitively)

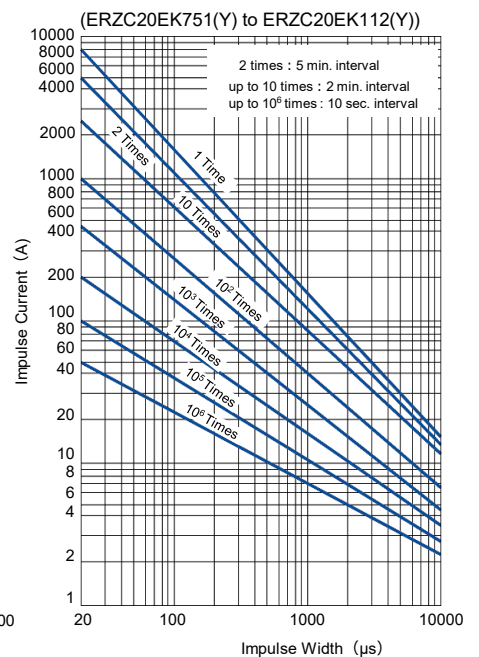
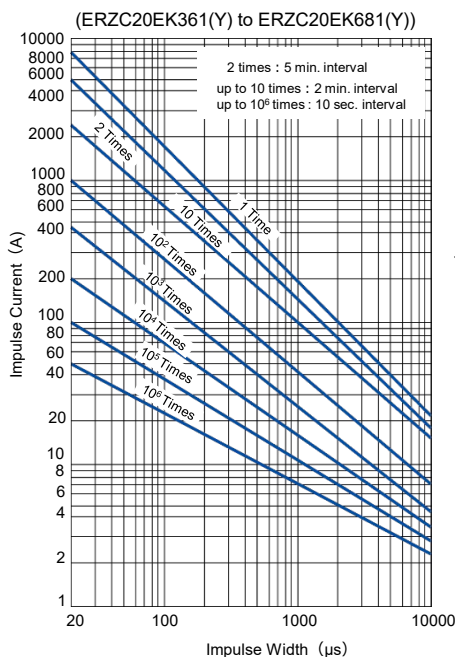
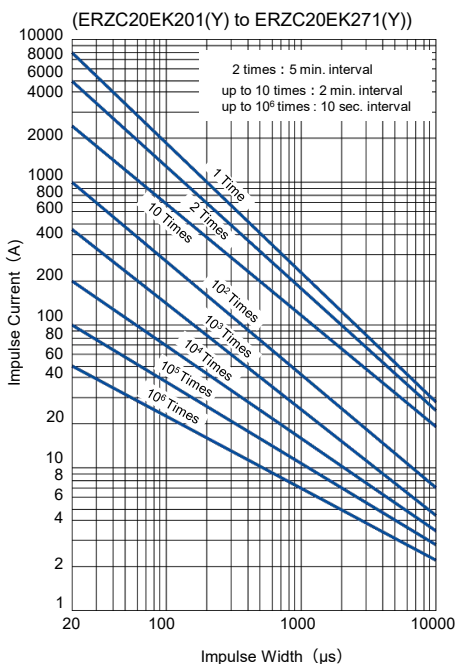

Typical characteristics

Voltage vs. Current

(ERZC32EK201(Y) to ERZC32EK511(Y))

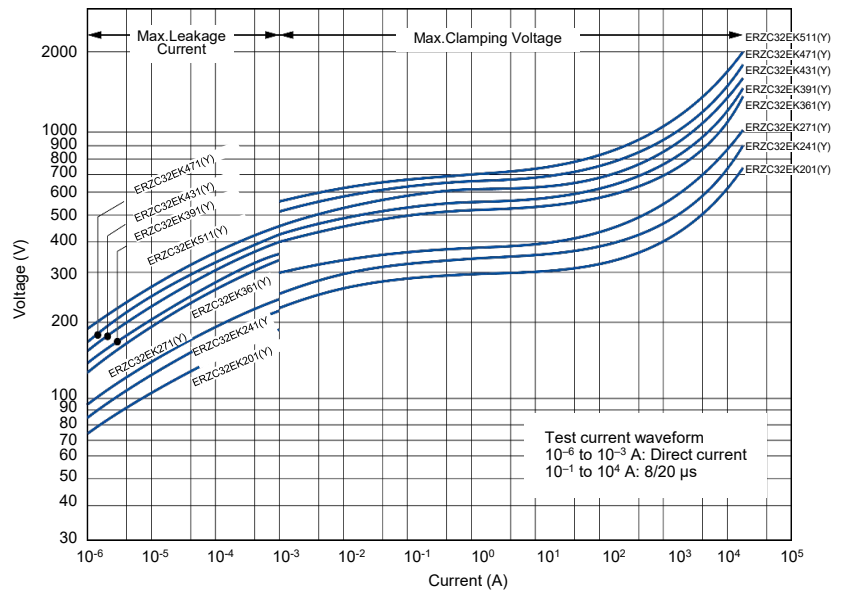

(ERZC32EK621(Y) to ERZC32EK112(Y))

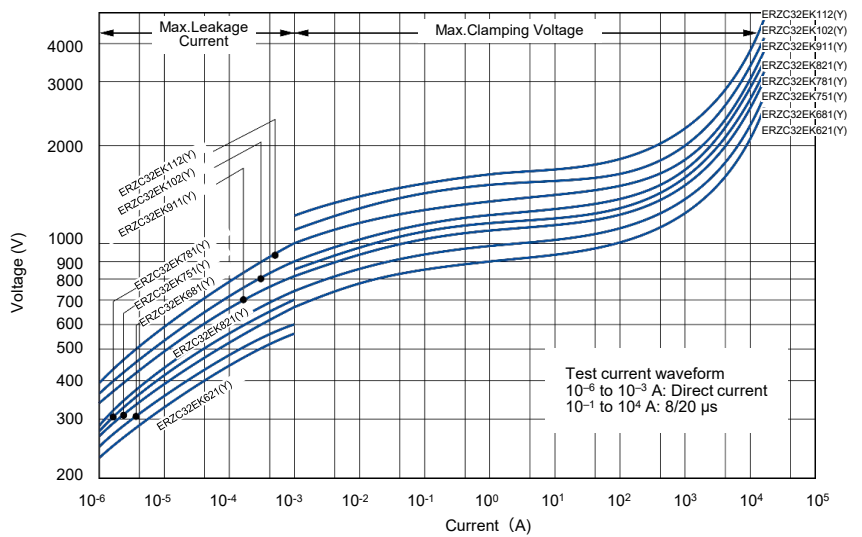

Impulse derating curve (Relation between impulse width and surge, repetitively)

(ERZC32EK201(Y) to ERZC32EK271(Y))

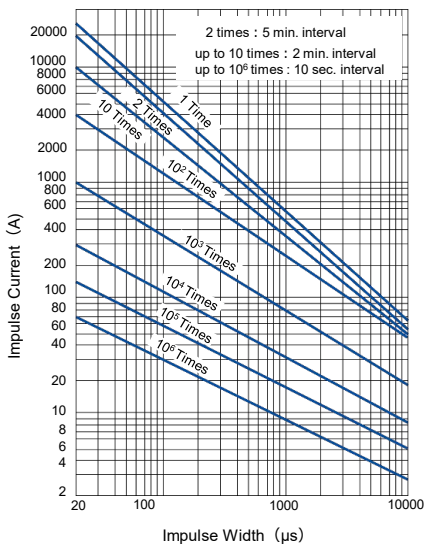

(ERZC32EK361(Y) to ERZC32EK681(Y))

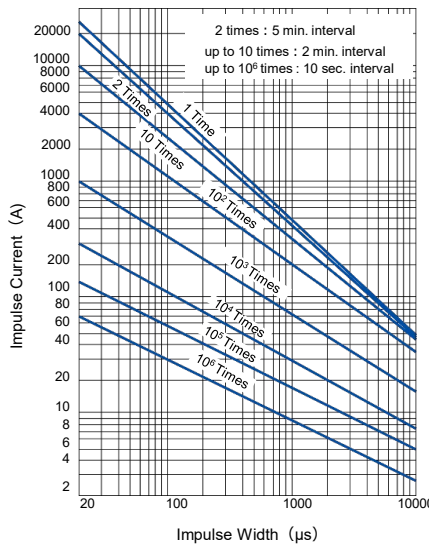

(ERZC32EK751(Y) to ERZC32EK112(Y))

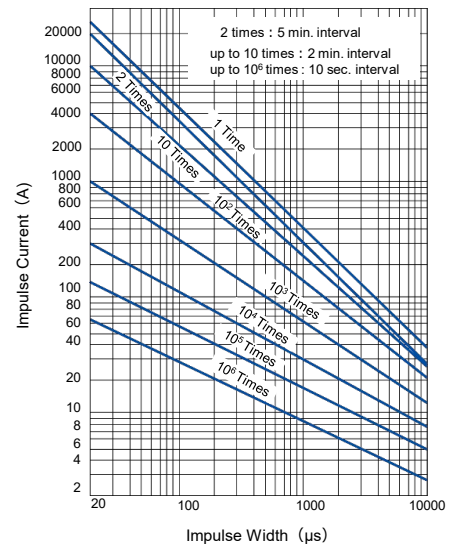

## Performance characteristics

Characteristics		Test methods / Description	Specifications															
Electrical	Standard test condition	Electrical measurements (initial/after tests) shall be conducted at temperature of 5 to 35 °C, relative humidity of maximum 85 %.	—															
	Varistor voltage	The voltage between two terminals with the specified measuring current $C_{mA}$ DC applied is called $V_C$ or $V_{CmA}$ . The measurement shall be made as fast as possible to avoid heat affection.	To meet the specified value															
	Maximum allowable voltage	The maximum sinusoidal wave voltage (rms) or the maximum DC voltage that can be applied continuously.																
	Clamping voltage	The maximum voltage between two terminals with the specified standard impulse current (8/20 $\mu$ s).																
	Rated power	The maximum power that can be applied within the specified ambient temperature.																
	Maximum energy	The maximum energy within the varistor voltage change of $\pm 10$ % when one impulse of 2 ms is applied.																
	Maximum peak current	2 times		The maximum current within the varistor voltage change of $\pm 10$ % with the standard impulse current (8/20 $\mu$ s) applied two times with an interval of 5 minutes.														
		1 time	The maximum current within the varistor voltage change of $\pm 10$ % with the standard impulse current (8/20 $\mu$ s) applied one time.															
	Temperature coefficient of varistor voltage	$\frac{V_C \text{ at } 70^\circ\text{C} - V_C \text{ at } 20^\circ\text{C}}{V_C \text{ at } 20^\circ\text{C}} \times \frac{1}{50} \times 100(\%/^\circ\text{C})$	0 to -0.05 %/ °C max.															
	Impulse life	The change of $V_C$ shall be measured after the impulse current listed below is applied 10000 times continuously with the interval of 10 seconds at room temperature. <table border="1" style="margin-left: auto; margin-right: auto;"> <tr> <td>Series 20</td> <td>200 A (8/20 <math>\mu</math>s)</td> </tr> <tr> <td>Series 32</td> <td>300 A (8/20 <math>\mu</math>s)</td> </tr> </table>	Series 20	200 A (8/20 $\mu$ s)	Series 32	300 A (8/20 $\mu$ s)	$\Delta V_{1\text{mA}}/V_{1\text{mA}} \leq \pm 10\%$											
Series 20	200 A (8/20 $\mu$ s)																	
Series 32	300 A (8/20 $\mu$ s)																	
Withstanding voltage (Body insulation)	The commercial frequency voltage of AC 2.5 kV shall be applied between terminals and the bottom of the unit for one minute.																	
Mechanical	Robustness of terminations (Tensile)	After gradually applying the load of 49 N (5 kgf) and keeping the unit fixed for 10 seconds in an axial direction, the terminal shall be visually examined for any damage.	No remarkable damage															
	Vibration	After repeatedly applying a single harmonic vibration (amplitude: 0.75 mm): double amplitude: 1.5 mm with 1 minute vibration frequency cycles (10 Hz to 55 Hz to 10 Hz) to each of three perpendicular directions for 2 hours. Thereafter, the damage of the terminals is visually examined.																
Environmental	Dry heat/ High temperature storage	The specimen shall be subjected to $110 \pm 3^\circ\text{C}$ for 500 hours in a thermostatic bath without load and then stored at room temperature and humidity for one to two hours. Thereafter, the change of $V_C$ shall be measured. <table border="1" style="margin-left: auto; margin-right: auto;"> <thead> <tr> <th>Step</th> <th>Temperature (°C)</th> <th>Period (minutes)</th> </tr> </thead> <tbody> <tr> <td>1</td> <td>-25      0              -3</td> <td>30      +3              .0</td> </tr> <tr> <td>2</td> <td>Room Temp.</td> <td>3 max.</td> </tr> <tr> <td>3</td> <td>85        +3              .0</td> <td>30      +3              .0</td> </tr> <tr> <td>4</td> <td>Room temp.</td> <td>3 max.</td> </tr> </tbody> </table>	Step	Temperature (°C)	Period (minutes)	1	-25      0 -3	30      +3 .0	2	Room Temp.	3 max.	3	85        +3 .0	30      +3 .0	4	Room temp.	3 max.	$\Delta V_{1\text{mA}}/V_{1\text{mA}} \leq \pm 5\%$
	Step	Temperature (°C)	Period (minutes)															
	1	-25      0 -3	30      +3 .0															
	2	Room Temp.	3 max.															
	3	85        +3 .0	30      +3 .0															
4	Room temp.	3 max.																
Temperature cycle	The temperature cycle shown below shall be repeated five times and then stored at room temperature and humidity for one to two hours. The change of $V_C$ and mechanical damage shall be examined.	$\Delta V_{1\text{mA}}/V_{1\text{mA}} \leq \pm 5\%$																
Dry heat load/ High temperature load	After being continuously applied the Maximum Allowable Voltage at $85 \pm 5^\circ\text{C}$ for 500 hours, the specimen shall be stored at room temperature and humidity for one to two hours. Thereafter, the change of $V_C$ shall be measured.	$\Delta V_{1\text{mA}}/V_{1\text{mA}} \leq \pm 10\%$																
Damp heat/Humidity (Steady state)	The specimen shall be subjected to $40 \pm 2^\circ\text{C}$ , 90 to 95 %RH for 1000 hours without load and then stored at room temperature and humidity for one to two hours. Thereafter, the change of $V_C$ shall be measured.	$\Delta V_{1\text{mA}}/V_{1\text{mA}} \leq \pm 5\%$																

## Minimum quantity / Packing unit

Product	Series / Type	Part number	Minimum quantity / Packing unit	Packing quantity in carton	Carton (about) L×W×H (mm)	
"ZNR" Transient/surge absorbers	E type	General product	ERZC□□EK□□□	5	100	380×405×85
		UL and CSA recognized	ERZC□□EK□□□Y	5	100	380×405×85

Part No., quantity and country of origin are designated on outer packages in English.

※ Please contact local sales office about packing specifications.

Design and specifications are each subject to change without notice. Ask factory for the current technical specifications before purchase and/or use.  
Should a safety concern arise regarding this product, please be sure to contact us immediately.



## **Guidelines and precautions regarding the technical information and use of our products described in this online catalog.**

- If you want to use our products described in this online catalog for applications requiring special qualities or reliability, or for applications where the failure or malfunction of the products may directly jeopardize human life or potentially cause personal injury (e.g. aircraft and aerospace equipment, traffic and transportation equipment, combustion equipment, medical equipment, accident prevention, anti-crime equipment, and/or safety equipment), it is necessary to verify whether the specifications of our products fit to such applications. Please ensure that you will ask and check with our inquiry desk as to whether the specifications of our products fit to such applications use before you use our products.
- The quality and performance of our products as described in this online catalog only apply to our products when used in isolation. Therefore, please ensure you evaluate and verify our products under the specific circumstances in which our products are assembled in your own products and in which our products will actually be used.
- Please ensure the safety by means of protection circuit, redundant circuit etc. in your system design in order to prevent the occurrence of life crisis and other serious damages due to the failure of our products.
- The products and product specifications described in this online catalog are subject to change for improvement without prior notice. Therefore, please be sure to request and confirm the latest product specifications which explain the specifications of our products in detail, before you finalize the design of your applications, purchase, or use our products.
- The technical information in this online catalog provides examples of our products' typical operations and application circuits. We do not guarantee the non-infringement of third party's intellectual property rights and we do not grant any license, right, or interest in our intellectual property.
- If any of our products, product specifications and/or technical information in this catalog is to be exported, the laws and regulations of the exporting country, especially with regard to security and export control, shall be observed.

## **<Regarding the Certificate of Compliance with the EU RoHS Directive/REACH Regulations>**

- The switchover date for compliance with the RoHS Directive/REACH Regulations varies depending on the part number or series of our products.
- When you use the inventory of our products for which it is unclear whether those products are compliant with the RoHS Directive/REACH Regulation, please select "Sales Inquiry" in the website inquiry form and contact us.

**Please note that we do not owe any liability and responsibility if our products are used beyond the description of this catalog or without complying with precautions in this catalog.**

## ⚠ Handling Precautions (E, CK, SC type)

### 1. Safety precautions

In case that a Varistors (ZNR Surge Absorber) (hereafter referred to as the ZNR, or product name) is used, if an abnormality takes place because of peripheral conditions of the ZNR (material, environments, power source conditions, circuit conditions, etc. in equipment design), fire, electric shock, burn, or product failure may occur. The precautions for this product are described below, understand the content thoroughly before usage. For more questions, contact us.

If there's any uncertainty/doubt/products safety items, please contact us. When a dogma shall be occurred about safety for this products, be sure to inform us rapidly, operate your technical examination.

### 2. Precautions to be strictly observed

#### 2.1 Confirmation of performance ratings

Use the ZNR within its rated range of performance such as the Max. allowable voltage, withstanding surge current, withstanding energy, impulse life (surge life), average pulse power, and operating temperature range. If used outside the range, the ZNR can be degrade and have element fracture, which may result in smoking and ignition.

#### 2.2 To avoid accidents due to unexpected phenomena, take the following measures

- Across-the-line use  
When the ZNR is used across a line, put a current fuse in series with the ZNR (Refer to Table 1).
- Use between line to ground
  - (1) If the case that the ZNR is used between a line to the ground, the short-circuit of the ZNR may not blow the current fuse because of grounding resistance, which may cause smoking and ignition of the ZNR's exterior resin.  
As the measure against it, install an earth leakage breaker on the power supply side of the ZNR position. If no earth leakage breaker is installed, use a thermal fuse together with a current fuse in series. (Refer to Table 1.)
  - (2) If the case that the ZNR is used between a live part to metal case, an electric shock may develop at a short-circuit of the ZNR; hence, ground the metal case to the ground or keep it from the human body.
- In the event of fracture of the ZNR, its pieces may scatter; hence, put the case or cover of the set product in place.
- Do not install the ZNR near combustible substances (polyvinyl chloride wires, resin moldings, etc.).  
If it is difficult to do, install a nonflammable cover.

#### 2.3 The live part shall be equipped with a protective cover for preventing electric shock.

#### 2.4 If ZNR is shorted out and happen smoke or ignition, please cut provided current to ZNR immediately.

### 3. Application notes

#### 3.1 Pay attention to the following items to avoid the shortened life and failure of the ZNR

##### 3.1-1 Circuit conditions

- (1) Select a ZNR of which the maximum voltage including fluctuations in source voltage allows for the
- (2) In cases that surges are intermittently applied at short intervals (for example, in the case that the voltage of the noise simulator test is impressed), do not cause them to exceed the ZNR's rated pulse power.
- (3) Select a ZNR recommended in Table 1.
  - ① Across-the-Line Use  
Use the part numbers marked with \* for A.C.100 and A.C.120 V if the power supply voltage is expected to rise temporarily due to load unbalance in a single wiring load in the case of a single-phase three-wire, short-circuit accident between voltage line and neutral line, missing neutral line accident, or resonance at switch opening/closing in the case of capacitive load, etc.
  - ② Line to ground Use
    - When DC500V insulation resistance test of the circuits employing ZNR is conducted, the ZNR shall be removed after getting approval from the customer, or the ZNR \*\* with the Maximum Allowable voltage exceeding to the test voltage shall be applied.
    - When AC1000V dielectric with standing test is conducted, ZNR shall be removed after getting approval from the customer according to the relevant regulations, or the ZNR \*\*\* with the Maximum Allowable voltage exceeding to the test voltage shall be applied.

#### ● Example of fuse selection

Series	ERZC20EK□□□(□)	ERZC32EK□□□(□)	ERZVS34C□□□	ERZC□□CK□□□W
Current fuse (Line - Line)	10 A max.	20 A max.	20 A max.	20 A max.
Thermal fuse (Line - Ground)	100 to 120 °C 5 A	100 to 120 °C 10 A	100 to 120 °C 10 A	100 to 120 °C 10 A

- ◆ Fuses shall use rated voltages appropriate for circuits.
- ◆ The examples of fuse selection shown above are only for reference and may vary depending on the operating circuit conditions. Therefore, confirm the fuse selection by testing, etc.
- ◆ Set a thermal fuse to get high thermal conductivity with ZNR.
- ◆ Finally, confirm that a secondary disaster will not occur if the ZNR breaks in the actual unit.



The recommended fuse insertion point is the application example shown in Table 1. However, insert a current fuse as shown in the figure below if the load current of the protected equipment is large and exceeds the rated current of the example of fuse selection shown on the previous page.

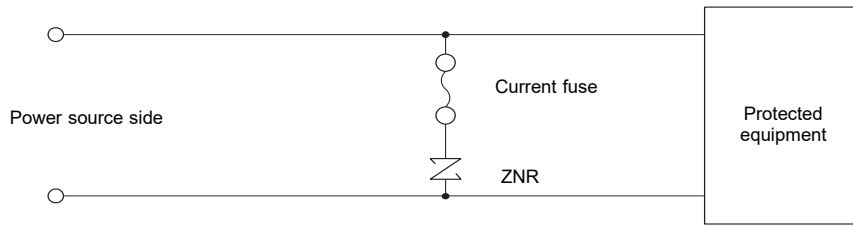

Table 1 Example of ZNR application

		Across-the-Line use		Use between Line to ground																					
Connections example	DC/AC Single-phase																								
	AC 3-phase																								
	Selection Examples		<table border="1"> <thead> <tr> <th>ZNR</th> <th>Nominal line voltage [AC]</th> <th colspan="2">Part Number of ZNR</th> </tr> <tr> <td></td> <td></td> <th colspan="2">E, CK, SC type</th> </tr> </thead> <tbody> <tr> <td rowspan="4">ZNR 1 ZNR 3</td> <td>100 V</td> <td rowspan="4">ERZC□□EK ERZC□□CK ERZVS34C</td> <td>201</td> <td rowspan="4">471 511 821 and more ** Regarding the part applying to AC withstanding voltage test, please ask us.</td> </tr> <tr> <td>120 V</td> <td>241 271*</td> </tr> <tr> <td>200 V to 220 V</td> <td>471</td> </tr> <tr> <td>240 V</td> <td>511</td> </tr> </tbody> </table>	ZNR	Nominal line voltage [AC]	Part Number of ZNR				E, CK, SC type		ZNR 1 ZNR 3	100 V	ERZC□□EK ERZC□□CK ERZVS34C	201	471 511 821 and more ** Regarding the part applying to AC withstanding voltage test, please ask us.	120 V	241 271*	200 V to 220 V	471	240 V	511			
		ZNR	Nominal line voltage [AC]	Part Number of ZNR																					
			E, CK, SC type																						
ZNR 1 ZNR 3		100 V	ERZC□□EK ERZC□□CK ERZVS34C	201	471 511 821 and more ** Regarding the part applying to AC withstanding voltage test, please ask us.																				
	120 V	241 271*																							
	200 V to 220 V	471																							
	240 V	511																							

### 3.1-2 Operating environments

- (1) The ZNR is designed and manufactured for application in general purpose electronic devices.  
The ZNR shall not be exposed to the weather, except for usage inside unit.
- (2) Do not use the ZNR in places exposed to temperatures beyond the operating temperature range, such as places exposed to sunlight and vicinities of heating equipment.
- (3) Do not use the ZNR in places exposed to high temperatures and high humidity, such as places exposed directly to rain, wind, dew condensation, and vapor.
- (4) Do not use the ZNR in dusty and salinity environment and atmospheres polluted by corrosive gases, in liquids such as water, oil, chemical, organic solvent.

### 3.1-3 Processing conditions

- (1) Do not wash the ZNR by such solvents(thinner, acetone, etc.) as its exterior resin deteriorates.
- (2) Do not apply a strong vibration or shock (by falling, etc.) to the ZNR, cracking to its exterior resin and element may occur. and element may occur.
- (3) When coating the ZNR with resin(including molding), do not use such resin.
- (4) Do not bend the ZNR lead wires at the position close to its ZNR exterior resin, or apply external force to the position.
- (5) When soldering the ZNR lead wires, follow the recommended condition and do not melt the solder and insulating materials constituting the ZNR.
- (6) Keep the wiring of the ZNR as short and straight as possible.

### 3.1-4 Long-term storage

- (1) Do not store the ZNR under high temperature and high humidity. Store it indoor environment at a temperature up to 40 °C and at humidity below 75 %RH, and use it within two years.  
Before using the ZNR that has been stored for a long period(two years or longer), confirm the solderability.
- (2) Avoid atmospheres full of corrosive gases (hydrogen sulfide, sulfurous acid, chlorine, ammonia, etc.).
- (3) Avoid direct sunlight and dew condensation.

### 3.1-5 About rated voltage for UL, etc.

In order to meet the leakage current regulation, the rated voltage is specified along with the maximum allowable circuit voltage. When applying for certification of the equipment with ZNR installed, the working voltage of the equipment should not exceed the rated voltage for UL, etc. of ZNR.

### 3.1-6 Fall

Do not drop the product on the floor or other surfaces. Do not use a ZNR that has been dropped as it may be mechanically or electrically damaged.

## 4. Notices

- In cases that the ZNR is used in equipment (aerospace equipment, medical equipment, etc.) requiring extremely high reliability, ask us for selection of part No., and protection coordination, etc. in advance.
- There is possibility that the ZNR will unexpectedly smoke or ignite because of abnormal rise of the circuit voltage and invasion of excessive surge.
- To prevent that accident from spreading over the equipment and not to expand the damage, use multiplex protection such as the adoption of flame-retardant materials for housing parts and structural parts.
- We shall not be responsible for any failure or abnormality caused by the use of this product that deviates from the contents of this catalog or does not comply with the precautions.
- Package marking includes the product number, quantity, and country of origin. As a rule, country of origin should be indicated in English.

## 5. Applicable laws and regulations , others

- This product not been manufactured with any ozone depleting chemical controlled under the Montreal Protocol.
- Specified brominated flame retardants (including PBB (polybromobiphenyl) and PBDE (polybromodiphenyl ether)) are not intentionally used in the components of this product.
- This product comply with RoHS(Restriction of the use of certain Hazardous Substance in electrical and electronic equipment) (DIRECTIVE 2011/65/EU and 2015/863/EU).
- All the materials used in this part are registered material under the Law Concerning the Examination and Regulation of Manufacture, etc. of Chemical Substance.
- If you need the notice by letter of "A preliminary judgement on the Laws of Japan foreign exchange and Foreign Trade Control", be sure to let us know.
- These products are not dangerous goods on the transportation as identified by UN(United nations) numbers or UN classification.

## 6. Others

- As to the disposal of ZNR, check the method of disposal in each country or origin where the ZNR are incorporated in your products to be used.
- The technical information in this specification provides example of our products' typical operations and application circuit. We do not guarantee the non-infringement of third party's intellectual property rights and we do not grant any license, right or interest in our intellectual property.