

Click to
ORDER
samples

AMEOF45-JZ

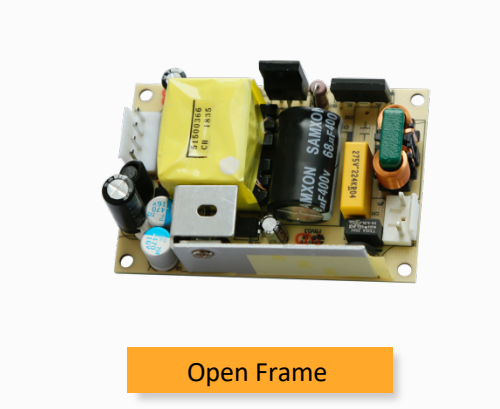

Open Frame

The AMEOF45-JZ series is one of Aimtec’s compact size open frame 45W AC/DC converter. It features universal AC input of 85 – 264VAC and at the same time accepts a DC input voltage range of 100 – 370VDC. Furthermore, the AMEOF45-JZ has a low power consumption, high efficiency up to 87%, high reliability and reinforced isolation of 3000VAC.

It offers an EMC compliance of IEC/EN61000-4 and CISPR32/EN5 5032 and meets IEC/EN/UL 62368 standards. The converters also include output short circuit, over-current & over-voltage protection. These converters are widely used in industrial, office and civil applications, such as modems, printers and telecom devices. For extremely harsh EMC environments, we recommend using the Typical Application Circuit on this datasheet.

Features



- Universal Input: 85 - 264VAC/100 - 370VDC
- Operating Temp: -25 °C to +70 °C
- High isolation voltage: 3000VAC
- Low ripple & noise, 100mV(p-p), typ.
- Output short circuit, over-current, over-voltage protection
- Regulated Output

Summary

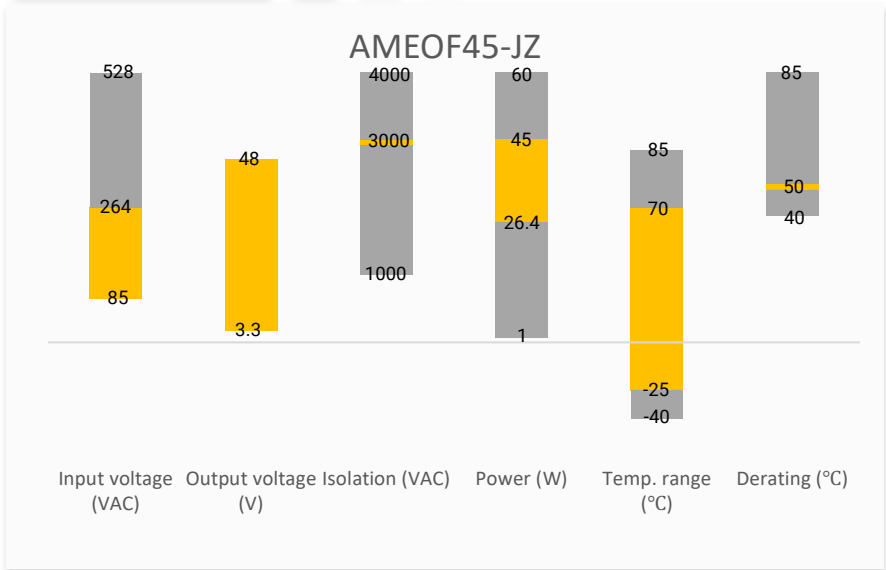

Training

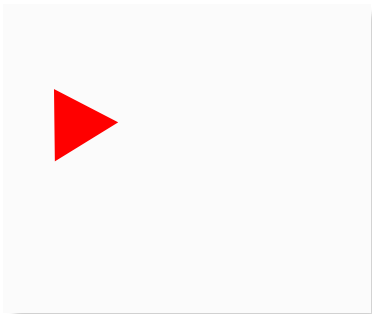

Product Training Video
(click to open)

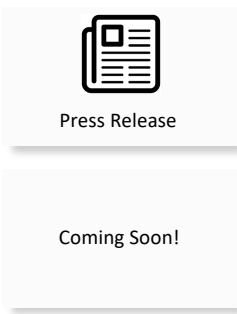

Application Notes

Applications



Power Grid



Industrial



Telecom



Instrumentation

Models & Specifications

Single Output							
Model	Input Voltage (VAC/Hz)	Input Voltage (VDC)	Max Output wattage (W)	Output Voltage (V)	Output Current max (A)	Maximum capacitive load (μF)	Efficiency @ 230VAC Typ. (%)
AMEOF45-3.3SJZ	85-264/47-63	100-370	26.4	3.3	8	30,000	76
AMEOF45-5SJZ	85-264/47-63	100-370	40	5	8	20,000	82
AMEOF45-9SJZ	85-264/47-63	100-370	40	9	4.44	6,000	84
AMEOF45-12SJZ	85-264/47-63	100-370	45	12	3.75	4,000	84
AMEOF45-15SJZ	85-264/47-63	100-370	45	15	3	3,500	86
AMEOF45-24SJZ	85-264/47-63	100-370	45	24	1.88	1,000	86
AMEOF45-48SJZ	85-264/47-63	100-370	45	48	0.94	600	87

Input Specifications					
Parameters	Conditions	Minimum	Typical	Maximum	Units
Current	115VAC			1.2	A
	230VAC			0.7	A
Inrush current	115VAC		35		A
	230VAC		50		A

Output Specifications				
Parameters	Conditions	Typical	Maximum	Units
Voltage accuracy	3.3V Output	±3		%
	Others	±2		%
Line regulation	Full load	±0.5		%
Load regulation	0-100% load	±1		%
Ripple & Noise*	20MHz bandwidth		100	mV p-p
Hold up time	230VAC	50		ms

* Ripple and Noise are measured at 20MHz bandwidth by using the referenced Application circuit.

Isolation Specifications				
Parameters	Conditions	Typical	Rated	Units
Tested I/O voltage	60 sec, leakage current < 5mA		3000	VAC

General Specifications				
Parameters	Conditions	Typical	Maximum	Units
Protection class	Class II			
Over Current protection	Auto recovery	≥ 150	300	% of Iout
Over voltage protection	3.3V Vout		≤ 7.5	VDC
	5V Vout		≤ 9	
	9V Vout		≤ 16	
	12V Vout		≤ 20	
	15V Vout		≤ 24	

	24V Vout		≤ 35	
	48V Vout		≤ 60	
Short circuit protection	Hiccup, Continuous			
Short circuit restart	Auto recovery			
Switching Frequency		65		KHz
Operating temperature	See derating graph	-25 to +70		°C
Storage temperature		-25 to +85		°C
Power consumption			0.5	W
Power Derating	-25 °C to -10 °C	2.0		% / °C
	+50 °C to +70 °C	2.5		
	85VAC to 165VAC	0.375		% / VAC
	240VAC to 264VAC	0.833		
Temperature coefficient		±0.02		% / °C
Cooling	Free air convection			
Humidity	Non-condensing		90	% RH
Weight			90	g
Dimensions (L x W x H)	PCB mountable models	3.00 x 2.00 x 1.18 inches (76.20 x 50.80 x 30.00mm)		
MTBF	> 300 000 hrs (MIL-HDBK -217F, t _a =+25°C)/Full Load			
NOTE: All specifications in this datasheet are measured at an ambient temperature of 25°C, humidity<75%, nominal input voltage and at rated output load unless otherwise specified.				

Safety Specifications		
Parameters		
Agency approvals	UL 62368-1	
Standards	Information technology Equipment	Design to meet IEC/EN 62368-1
	EMC - Conducted and radiated emission	CISPR32 / EN55032, class B
	Electrostatic Discharge Immunity	IEC 61000-4-2 Contact ±6KV, Criteria B
	RF, Electromagnetic Field Immunity	IEC 61000-4-3 10V/m, Criteria A
	Electrical Fast Transient/Burst Immunity	IEC 61000-4-4 ±2KV, Criteria B
	Surge Immunity	IEC 61000-4-5 L-L ±1KV, Criteria B
	RF, Conducted Disturbance Immunity	IEC 61000-4-6 10Vr.m.s, Criteria A
	Voltage dips, Short Interruptions Immunity	IEC 61000-4-11 0%, 70%, Criteria B

Derating

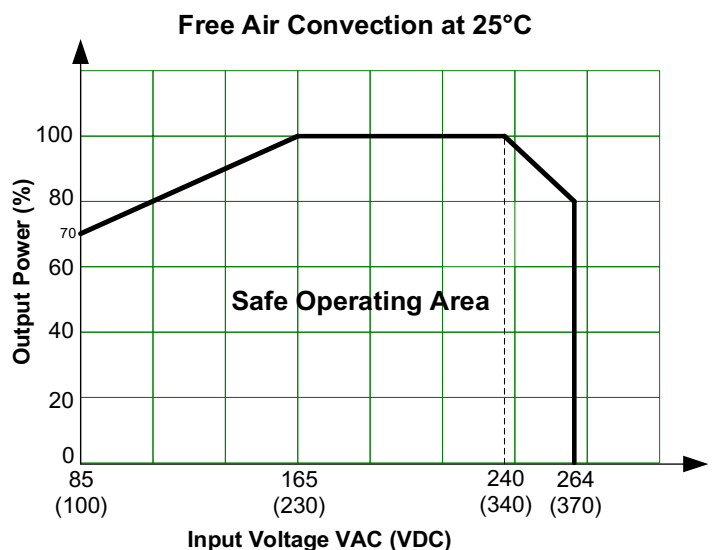
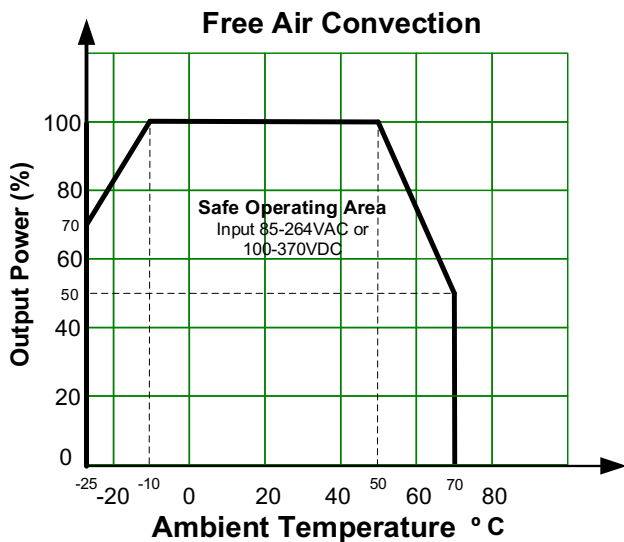

Typical Application Circuit

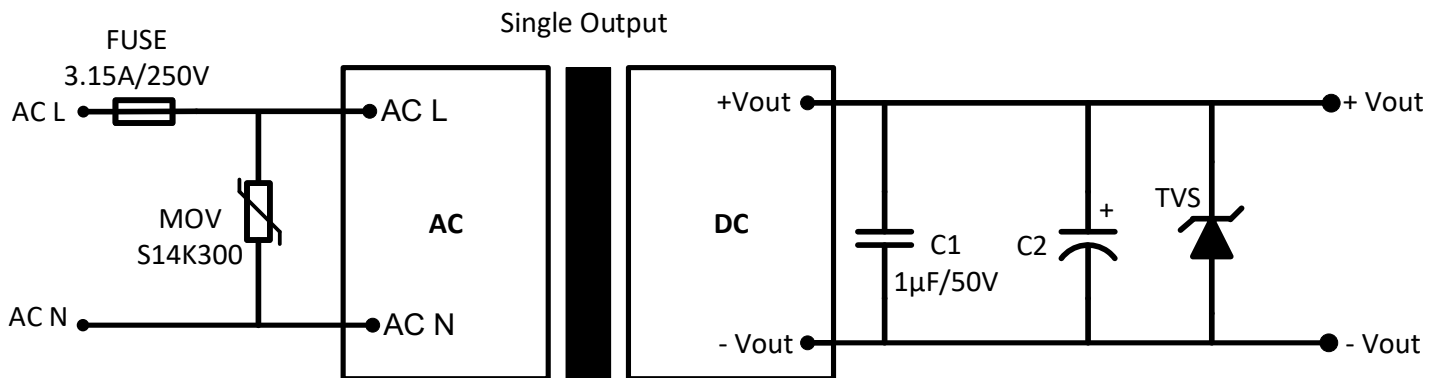

Model	C2	TVS
3.3 / 5 Vout	680 μF / 10V	7V
9 Vout	47 μF / 16V	12V
12 / 15 Vout	47 μF / 25V	20V
24 Vout	47 μF / 35V	30V
48 Vout	47 μF / 63V	64V

For Filtering Components:

The C2 capacitor is recommended to use electrolytic type with high frequency and low ESR rating. The C1 capacitor is recommended to use ceramic type for filtering high-frequency noise. The TVS is recommended suppressor diode.

Dimensions

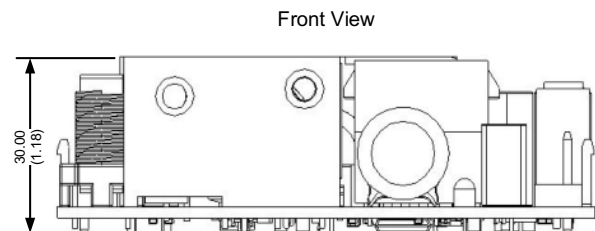
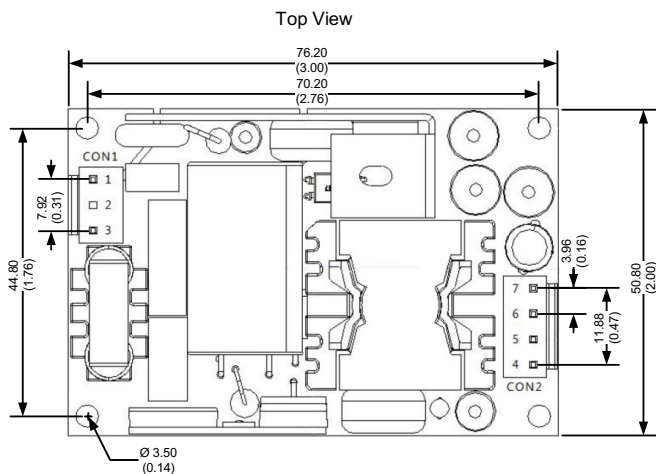

All dimensions are typical: millimeters (inches)
 General Tolerances : ± 0.5 (± 0.02)
 CON1 model: VH-3A (Terminal: VH-3Y)
 CON2 model: VH-4A (Terminal: VH-4Y)
 Mounting hole screwing torque: Max 0.4 N.m

Pin Output Specifications

Pin	Function	Connector	Terminal
1	AC Input (L)	VH-3A or the same Spec.	VH-3Y or the same Spec.
2	No Pin		
3	AC Input (N)		
4	-V Output	VH-4A or the same Spec.	VH-4Y or the same Spec.
5	-V Output		
6	+V Output		
7	+V Output		

NOTE: **1.** Datasheets are updated as needed and as such, specifications are subject to change without notice. Once printed or downloaded, datasheets are no longer controlled by Aimtec; refer to www.aimtec.com for the most current product specifications. **2.** Product labels shown, including safety agency certifications on labels, may vary based on the date manufactured. **3.** Mechanical drawings and specifications are for reference only. **4.** All specifications are measured at an ambient temperature of 25°C, humidity<75%, nominal input voltage and at rated output load unless otherwise specified. **5.** Aimtec may not have conducted destructive testing or chemical analysis on all internal components and chemicals at the time of publishing this document. CAS numbers and other limited information are considered proprietary and may not be available for release. **6.** This product is not designed for use in critical life support systems, equipment used in hazardous environments, nuclear control systems or other such applications which necessitate specific safety and regulatory standards other the ones listed in this datasheet. **7.** Warranty is in accordance with Aimtec's standard Terms of Sale available at www.aimtec.com.