

Data sheet | Item number: 770-282

Socket; 2-pole; Cod. B; 4,00 mm²; pink

www.wago.com/770-282

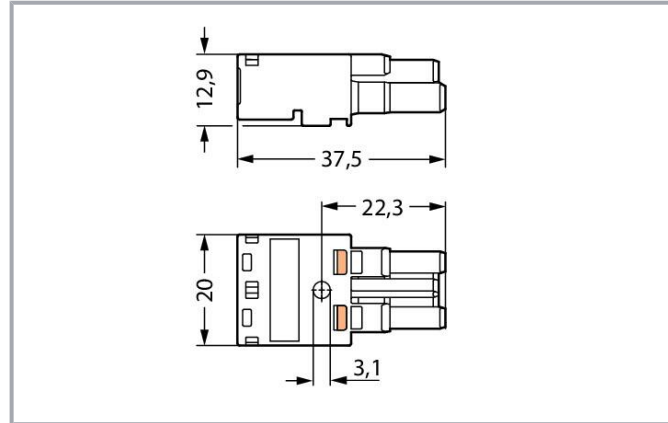
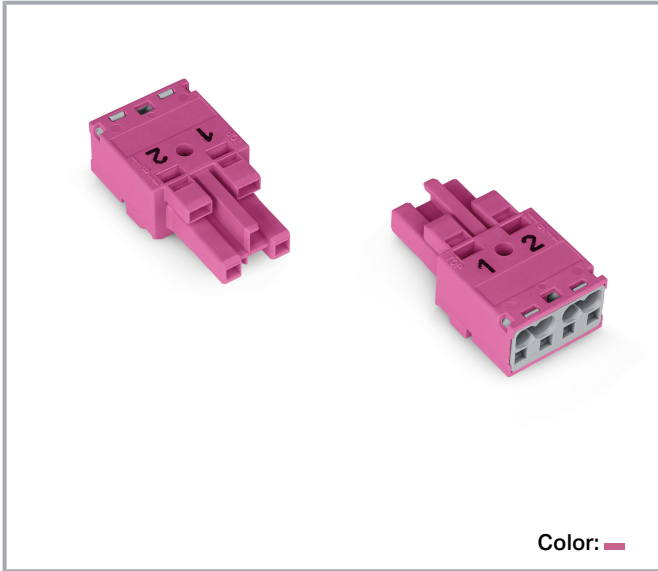

Item description

Female connector/socket *WINSTA*® MIDI with protection type IP20

The *WINSTA*® MIDI female connector/socket rated current 25 A supports fast, reliable installation. On PCBs, in control cabinets or for connecting lights – pluggable installation connectors from WAGO allow you to establish connections according to an enormous variety of requirements in next to no time. The coding options reduce installation errors, allowing fast, secure wiring of all components. The pluggable installation connector is protected against ingress by solid objects in accordance with protection type IP20 (When mated and secured with a strain relief housing: IP2xC (These compact connectors are not designed for use in open, easily accessible areas!)). B coding enables the *WINSTA*® MIDI pluggable installation connectors to be used for control in applications in the domains of automation, mechanical engineering and robotics. This pluggable installation connector is used for electrical currents up to 25 A. Thus the product is especially suitable for high power loads. The *WINSTA*® MIDI product line guarantees total flexibility for the installation of applications. With its Push-in CAGE CLAMP® spring pressure connection technology, it achieves error-free, time-saving installation and offers flexibility and customization for meeting all installation requirements.

Lower costs through fast commissioning and elimination of service expenses – solutions from *WINSTA*® MIDI

WINSTA® is the pluggable connection system that is perfectly tailored to the strict requirements of electrical installation. It ensures error-free installation of cables and components, quickly and reliably. Choose quality and durability – the *WINSTA*® MIDI pluggable installation connector with

Subject to changes. Please also observe the further product documentation!

WAGO GmbH & Co. KG
Hansastr. 27
32423 Minden
Phone: +49571 887-0 | Fax: +49571 887-169
Email: info.de@wago.com | Web: www.wago.com

Do you have any questions about our products?
We are always happy to take your call at +49 (571) 887-44222.



protection against mismatching from WAGO makes the electrical installation of electrical components visibly easier.

- effective protection against mismatching
- for automation controllers
- with B coding for controllers such as sun blinds and lighting fixtures
- ready for immediate use
- fast, secure installation

Data Notes

Variants: Other pole markings
Other versions (or variants) can be requested from WAGO Sales or configured at <https://configurator.wago.com/>.

Electrical data

Ratings per IEC/EN

Ratings per	IEC/EN 60664-1
Nominal voltage (III/3)	250 V
Rated impulse voltage (III/3)	4 kV
Rated current	25 A
Legend (ratings)	(III / 3) ≙ Overvoltage category III / Pollution degree 3

Ratings per UL 1977

Note for the US market	Some versions may also be used for current interruption in accordance with the UL certificate in select applications with currents below 16 A and voltages up to 600 V. For further information, please contact your local sales office.
Rated voltage (UL 1977)	600 V
Rated current UL 1977	23 A

General

Note on contact resistance	approx. 1 mΩ of contact resistance approx. 0.25 mΩ contact transition plug/socket
----------------------------	--

Subject to changes. Please also observe the further product documentation!



Connection data

Connection points	4
Total number of potentials	2

Connection 1

Connection technology	Push-in CAGE CLAMP®
Actuation type	Operating tool Push-in
Nominal cross-section	4 mm ² / 12 AWG
Solid conductor	0.5 ... 4 mm ² / 20 ... 12 AWG
Solid conductor; push-in termination	1.5 ... 4 mm ² / 16 ... 12 AWG
Stranded conductor	0.5 ... 2.5 mm ² / 20 ... 14 AWG
Fine-stranded conductor	0.5 ... 4 mm ² / 20 ... 12 AWG
Fine-stranded conductor; with insulated ferrule	0.25 ... 1.5 mm ² / 20 ... 16 AWG
Fine-stranded conductor; with uninsulated ferrule	0.25 ... 2.5 mm ² / 20 ... 14 AWG
Fine-stranded conductor; with ferrule; push-in termination	1.5 mm ² / 16 AWG
Strip length	9 mm / 0.35 inches
Pole number	2
Conductor entry direction to mating direction	0°

Physical data

Pin spacing	10 mm / 0.394 inches
Width	20 mm / 0.787 inches
Height	12.9 mm / 0.508 inches
Depth	37.5 mm / 1.476 inches

Mechanical Data

Application	Control technology
Coding	B
Variable coding	No
Marking	1 2
Potential marking	1 2
Mating force of a plug-in connection	approx. 20 ... 70 N (depending on pole number)
Retention force of a plug-in connection	Locked: > 80 N
Unmating force of a plug-in connection	Unlocked: approx. 20 ... 70 N (depending on pole number)

Subject to changes. Please also observe the further product documentation!



Number of mating cycles	200, without resistive load
Protection type	IP20; When mated and secured with a strain relief housing: IP2xC (These compact connectors are not designed for use in open, easily accessible areas!)

Plug-in connection

Contact type (pluggable connector)	Female connector/socket
Connector (connection type)	for conductor
Mismating protection	Yes
Note on mismating protection	All <i>WINSTA</i> [®] components are 100% protected against mismating when: a.) plugging different numbers of poles b.) plugging while rotated 180 c.) plugging while laterally staggered d.) plugging one pole
Locking lever	Can be retrofitted
Locking of plug-in connection	locking lever
Note on locking system	All connectors for mounted installations (snap-in versions for lighting fixtures or devices, all types of PCB and distribution connectors) are factory-equipped with locking levers to ensure plugs and sockets are securely locked. Additional locking levers are only required for flying leads (plug/socket).

Material Data

Note (material data)	Information on material specifications can be found here
Color	pink
Cover color	gray
Material group	I
Insulation material	Polyamide (PA66)
Flammability class per UL94	V0
Clamping spring material	Chrome-nickel spring steel (CrNi)
Contact material	Copper or copper alloy; surface-treated
Contact plating	Tin
Fire load	0.127 MJ
Weight	6.6 g

Subject to changes. Please also observe the further product documentation!

WAGO GmbH & Co. KG
Hansastr. 27
32423 Minden
Phone: +49571 887-0 | Fax: +49571 887-169
Email: info.de@wago.com | Web: www.wago.com

Do you have any questions about our products?
We are always happy to take your call at +49 (571) 887-44222.

Environmental requirements

Processing temperature	-5 ... +40 °C
Continuous operating temperature	-35 ... +85 °C
Note on continuous operating temperature	Insulating parts for temperatures ≤ 105 °C

Commercial data



Product Group	20 (Winsta)
eCl@ss 10.0	27-44-06-05
eCl@ss 9.0	27-44-06-05
ETIM 8.0	EC002560
ETIM 7.0	EC002560
PU (SPU)	100 pcs
Packaging type	box
Country of origin	DE
GTIN	4050821541905
Customs tariff number	85366990990

Environmental Product Compliance

RoHS Compliance Status	Compliant, No Exemption
------------------------	-------------------------

Approvals / Certificates

General approvals

Logo	Approval	Additional Approval Text	Certificate name
	CCA DEKRA Certification B.V.	EN 61984	2173495.01
	CCA DEKRA Certification B.V.	IEC 61984	NL-32104
	cURus Underwriters Laboratories Inc.	UL 1977	E45171

Declarations of conformity and manufacturer's declarations

Logo	Approval	Additional Approval Text	Certificate name
------	----------	--------------------------	------------------

Subject to changes. Please also observe the further product documentation!

WAGO GmbH & Co. KG
 Hansastr. 27
 32423 Minden
 Phone: +49571 887-0 | Fax: +49571 887-169
 Email: info.de@wago.com | Web: www.wago.com

Do you have any questions about our products?
 We are always happy to take your call at +49 (571) 887-44222.



EU-Declaration of Conformity
WAGO GmbH & Co. KG

-

-





UK-Declaration of Conformity
WAGO GmbH & Co. KG





-

-

Approvals for marine applications

Logo	Approval	Additional Approval Text	Certificate name
	ABS American Bureau of Shipping	-	19- HG1868589- PDA
	DNV GL Det Norske Veritas, Germanischer Lloyd	-	TAE00001Z6
	LR Lloyds Register	IEC 61984	LR22429487TA

Counterpart

	Item no.770-1603 T-distribution connector; 2-pole; Cod. B; 1 input; 2 outputs; 2 locking levers; pink	www.wago.com/770-1603
	Item no.770-1610 h-distribution connector; 2-pole; Cod. B; 1 input; 2 outputs; outputs on both sides; 2 locking levers; pink	www.wago.com/770-1610
	Item no.770-1653 h-distribution connector; 2-pole; Cod. B; 1 input; 2 outputs; outputs on one side; 2 locking levers; pink	www.wago.com/770-1653
	Item no.770-1703 T-distribution connector; 2-pole; Cod. B; 1 input; 2 outputs; 3 locking levers; for flying leads; pink	www.wago.com/770-1703
	Item no.770-1706 3-way distribution connector; 2-pole; Cod. B; 1 input; 3 outputs; pink	www.wago.com/770-1706
	Item no.770-1660	

Subject to changes. Please also observe the further product documentation!

WAGO GmbH & Co. KG
Hansastr. 27
32423 Minden
Phone: +49571 887-0 | Fax: +49571 887-169
Email: info.de@wago.com | Web: www.wago.com

Do you have any questions about our products?
We are always happy to take your call at +49 (571) 887-44222.



h-distribution connector; 2-pole; Cod. B; 1 input; 2 outputs; outputs on both sides; 3 locking levers; for flying leads; pink

www.wago.com/770-1660



Item no.770-1753

h-distribution connector; 2-pole; Cod. B; 1 input; 2 outputs; outputs on one side; 3 locking levers; for flying leads; pink

www.wago.com/770-1753



Item no.770-292

Plug; 2-pole; Cod. B; 4,00 mm²; pink

www.wago.com/770-292



Item no.771-8992/005-107

pre-assembled interconnecting cable; Eca; Socket/plug; 2-pole; Cod. B; Control cable 2 x 1.0 mm²; 1 m; 1,00 mm²; pink

www.wago.com/771-8992/005-107



Item no.771-8992/205-107

pre-assembled connecting cable; Eca; Plug/open-ended; 2-pole; Cod. B; Control cable 2 x 1.0 mm²; 1 m; 1,00 mm²; pink

www.wago.com/771-8992/205-107

Required accessories

Strain relief

Strain relief housing



Item no.: 770-502/041-000

Strain relief housing; 2-pole; with locking clip; for 1 cable; 7.0 ... 10.5 mm; 35 mm; black

www.wago.com/770-502/041-000



Item no.: 770-502/042-000

Strain relief housing; 2-pole; with locking clip; for 1 cable; 5.0 ... 9.0 mm; 35 mm; black

www.wago.com/770-502/042-000



Item no.: 770-512/041-000

Strain relief housing; 2-pole; with locking clip; for 1 cable; 7.0 ... 10.5 mm; 35 mm; white

www.wago.com/770-512/041-000



Item no.: 770-512/042-000

Strain relief housing; 2-pole; with locking clip; for 1 cable; 5.0 ... 9.0 mm; 35 mm; white

www.wago.com/770-512/042-000

Locking levers

Locking system



Item no.: 770-121

Locking lever; for flying leads; for manual operation; white

www.wago.com/770-121

Subject to changes. Please also observe the further product documentation!

WAGO GmbH & Co. KG

Hansastr. 27

32423 Minden

Phone: +49571 887-0 | Fax: +49571 887-169

Email: info.de@wago.com | Web: www.wago.com

Do you have any questions about our products?

We are always happy to take your call at +49 (571) 887-44222.



Item no.: 770-131
Locking lever; for flying leads; for tool operation; white

www.wago.com/770-131



Item no.: 770-101
Locking lever; for flying leads; for manual operation; black

www.wago.com/770-101



Item no.: 770-111
Locking lever; for flying leads; for tool operation; black

www.wago.com/770-111

Optional accessories

Mounting

Snap-in frame



Item no.: 770-317
Snap-in frame; 2-pole; 1.0 ... 3.0 mm; black

www.wago.com/770-317



Item no.: 770-337
Snap-in frame; 2-pole; 1.0 ... 3.0 mm; black

www.wago.com/770-337

Mounting accessories



Item no.: 897-2100
Mounting plate; for Snap-in; Plastic; for detectors and sensors ; Ø 200 mm; red

www.wago.com/897-2100

Cover

Cover



Item no.: 770-201
Lockout cap; 12-pole, separable; for sockets; Plastic; black

www.wago.com/770-201



Item no.: 770-221
Lockout cap; 12-pole, separable; for sockets; Plastic; white

www.wago.com/770-221



Item no.: 897-2003
Protective cap; Type2; for sockets and plugs; PVC; red

www.wago.com/897-2003

Tool

Operating tool



Item no.: 210-719
Operating tool; Blade: 2.5 x 0.4 mm; with a partially insulated shaft

www.wago.com/210-719

Subject to changes. Please also observe the further product documentation!



Item no.: 770-382
Operating tool; 2-way; green

www.wago.com/770-382

Downloads

Documentation

Bid Text

770-282 X81 - Datei	2019 Feb 19	xml 3.0 kB	Download
770-282 doc - Datei	2015 Jun 8	doc 24.6 kB	Download

CAD/CAE-Data

CAE data

EPLAN Data Portal 770-282	URL	Download
WSCAD Universe 770-282	URL	Download
ZUKEN Portal 770-282	URL	Download

CAD data

2D/3D Models 770-282	URL	Download
----------------------	-----	----------

Environmental Product Compliance

Compliance Search

Environmental Product Compliance 770-282 Socket; 2-pole; Cod. B; 4,00 mm ² ; pink	URL	Download
---	-----	----------

Installation Notes

Conductor termination

Subject to changes. Please also observe the further product documentation!

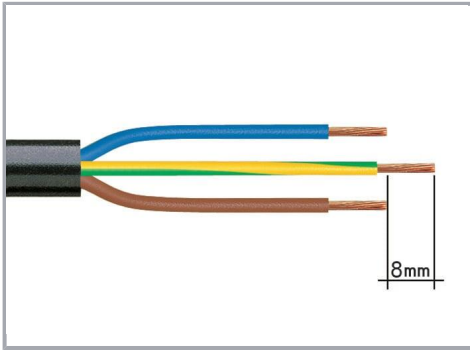

1. Strip length, outer insulation = 35 mm (2-pole), 55 mm (3- to 5-pole)
2. Strip length = 9 mm
3. Extended ground conductor = 8 mm

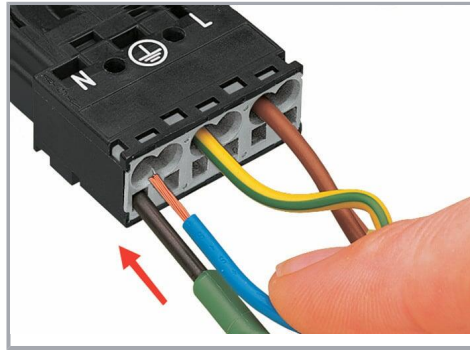

To terminate fine-stranded conductors, open the clamping unit via screwdriver (2.5 mm blade width) and insert a stripped conductor until it hits the backstop.

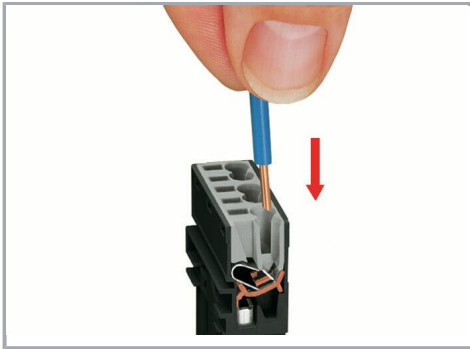

Insert the stripped solid conductor until it hits the backstop.

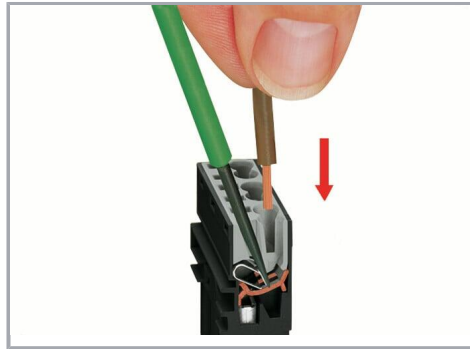

To terminate fine-stranded conductors, open the clamping unit via screwdriver (2.5 mm blade width) and insert a stripped conductor until it hits the backstop.

Conductor removal

Subject to changes. Please also observe the further product documentation!

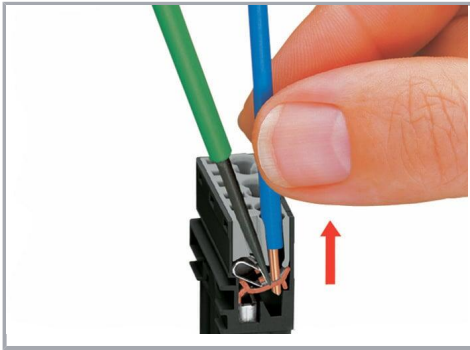

To remove the conductor, actuate the clamp via screwdriver (2.5 mm blade width) and pull out the conductor.

Installation

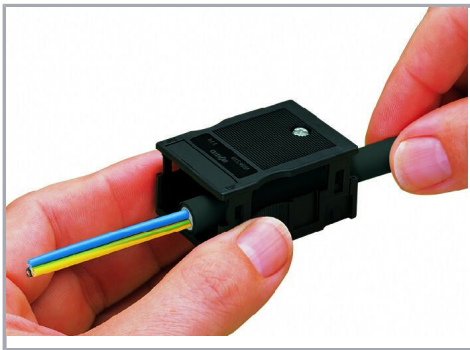

We recommend pulling the pre-latched strain relief housing over the cable prior to termination. However, the strain relief can be mounted at a later time as well.

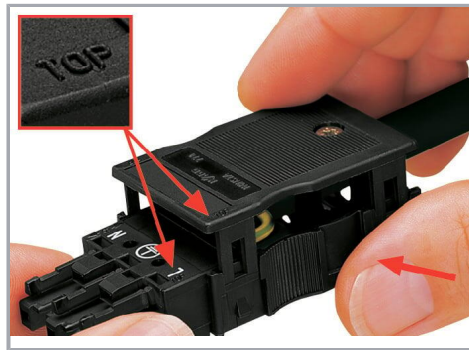

Latch the strain relief housing onto the plug /socket. Note the "TOP" inscription.

Subject to changes. Please also observe the further product documentation!

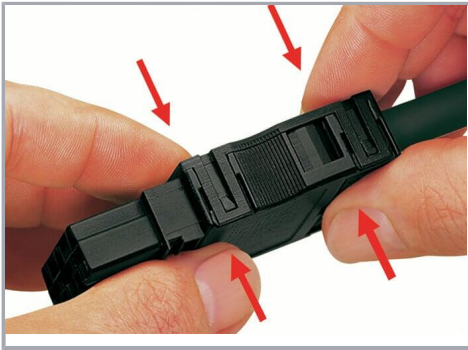

Prepare strain relief housing by snapping together upper and bottom part.



Tighten strain relief screw with screwdriver (2.5 mm blade width).

Coding



Simply cut off the coding pin from the socket.

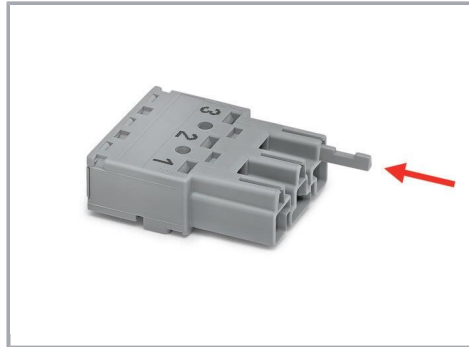

Insert coding pin into plug (break first) until it engages.

Mismatching protection

Subject to changes. Please also observe the further product documentation!

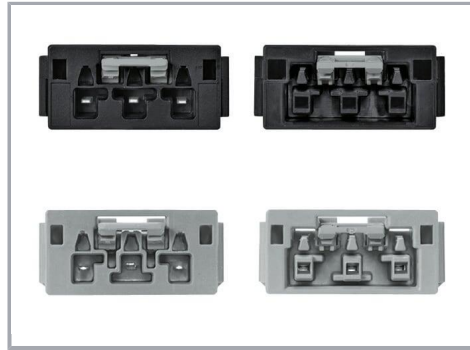
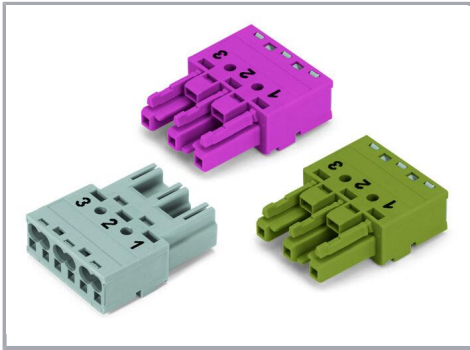

B-coded connectors with different colors can be plugged together.

Important note:

Different colors and/or pole markings are used for circuit identification.

Only connectors of the same color and same pole marking must be plugged together.

B-coded connectors (shown in gray) not only differ in color, but also in their design, making them incompatible with other coded connectors.



Easy circuit identification via different marking and colors

Product family

WINSTA® MIDI

[Show all products from the family](#)

Subject to changes. Please also observe the further product documentation!