

ARM[®] Cortex[®]-M
32-bit Microcontroller

NuMicro[®] Family
NuTiny-SDK-NUC029SEE
User Manual

The information described in this document is the exclusive intellectual property of Nuvoton Technology Corporation and shall not be reproduced without permission from Nuvoton.

Nuvoton is providing this document only for reference purposes of NuMicro[®] microcontroller based system design. Nuvoton assumes no responsibility for errors or omissions.

All data and specifications are subject to change without notice.

For additional information or questions, please contact: Nuvoton Technology Corporation.

www.nuvoton.com

Table of Contents

1 OVERVIEW 4

2 NUTINY-SDK-NUC029SEE INTRODUCTION 5

 2.1 NuTiny-SDK-NUC029SEE Jumper Description..... 6

 2.1.1 Power Setting 6

 2.1.2 Debug Connector 6

 2.1.3 USB Connector 6

 2.1.4 Extended Connector 6

 2.1.5 Reset Button..... 6

 2.1.6 Power Connector 6

 2.1.7 VCOM Enable 6

 2.2 Pin Assignment for Extended Connector 8

 2.3 NuTiny-SDK-NUC029SEE PCB Placement 18

3 How to Start NuTiny-SDK-NUC029SEE on the Keil mdk ENVIRONMENT 19

 3.1 Downloading and Installing Keil MDK Software..... 19

 3.2 Downloading and Installing Nuvoton Nu-Link Driver 19

 3.3 Hardware Setup..... 19

 3.4 Example Program..... 19

4 How to Start NuTiny-SDK-NUC029SEE on the IAR Embedded Workbench..... 21

 4.1 Downloading and Installing IAR Embedded Workbench Software 21

 4.2 Downloading and Installing Nuvoton Nu-Link Driver 21

 4.3 Hardware Setup..... 21

 4.4 Example Program..... 21

5 Starting to Use Nu-Link-Me 3.0 VCOM Function..... 23

 5.1 Downloading and Installing VCOM Driver 23

 5.2 VCOM Mode Setting on NuTiny-SDK-NUC029SEE 25

 5.3 Development Tool Setup 25

 5.3.1 Check the Using UART on the Keil μ Vision[®] IDE..... 25

 5.3.2 Check the Target Device and Debug Setting 26

 5.3.3 Build and Download Code to NuTiny-SDK-NUC029SEE 28

 5.3.4 Open the Serial Port Terminal 28

 5.3.5 Reset Chip 29

6 NuTiny-SDK-NUC029SEE Schematics 30

 6.1 Nu-Link-Me V3.0 Schematic 30

6.2 GPIO for 64 pin Schematic.....31

6.3 SDK Circuit Schematic.....32

6.4 Target Chip33

7 REVISION HISTORY 34

1 OVERVIEW

NuTiny-SDK-NUC029SEE is a specific development tool for NuMicro[®] NUC029SEE. With the NuTiny-SDK-NUC029SEE, user can develop and verify the application program easily.

The NuTiny-SDK-NUC029SEE includes two portions. One is NuTiny-EVB-NUC029SEE and the other is Nu-Link-Me. NuTiny-EVB-NUC029SEE is the evaluation board and Nu-Link-Me is its Debug Adaptor. Thus, user does not need other additional ICE or debug equipment.

The NUC029SEE can bridge the gap and replace the cost equivalent to traditional 8- and 16-bit microcontroller by 32-bit performance and rich functions. The NUC029SEE supports a wide range of applications from low-end, price sensitive designs to computing-intensive ones and provides advanced high-end features in economical products.

The NuMicro[®] NUC029SEE is embedded with the Arm[®] Cortex[®]-M0 core running up to 72 MHz and features 128 Kbytes Flash, 16 Kbytes SRAM, and 8 Kbytes loader ROM for the ISP. It is also equipped with plenty of peripheral devices, such as Timers, Watchdog Timer, Window Watchdog Timer, RTC, PDMA with CRC calculation unit, UART, SPI, I²C, PWM Timer, GPIO, LIN, CAN, USB 2.0 FS Device, 12-bit ADC, Low Voltage Reset Controller and Brown-out Detector.

Besides, the NUC029SEE is equipped with ISP (In-System Programming) and ICP (In-Circuit Programming) functions, which allow the user to update the program memory without removing the chip from the actual end product. The NUC029SEE also supports In-Application-Programming (IAP) function, user switches the code executing without the chip reset after the embedded flash updated.

2 NUTINY-SDK-NUC029SEE INTRODUCTION

The NuTiny-SDK-NUC029SEE uses the NUC029SEE as the target microcontroller. Figure 2-1 is NuTiny-SDK-NUC029SEE for the NUC029SEE, the left portion is called NuTiny-EVB-NUC029SEE and the right portion is Debug Adaptor called Nu-Link-Me.

The NuTiny-EVB-NUC029SEE is similar to other development boards. Users can use it to develop and verify applications to emulate the real behavior. The on board chip covers NUC029SEE features. The NuTiny-EVB-NUC029SEE can be a real system controller to design user's target systems.

Nu-Link-Me is a Debug Adaptor. The Nu-Link-Me Debug Adaptor connects your PC's USB port to your target system (via Serial Wired Debug Port) and allows you to program and debug embedded programs on the target hardware. The Nu-Link-Me V3.0 also supports VCOM function, which gives users more flexibility when debugging. To use the Nu-Link-Me Debug adaptor with IAR or Keil, please refer to "Nuvoton NuMicro® IAR ICE driver user manual" or Nuvoton NuMicro® Keil ICE driver user manual" in detail. These two documents will be stored in the local hard disk when the user installs each driver. To use Nu-Link-Me 3.0 VCOM function, please refer to Chapter 5.

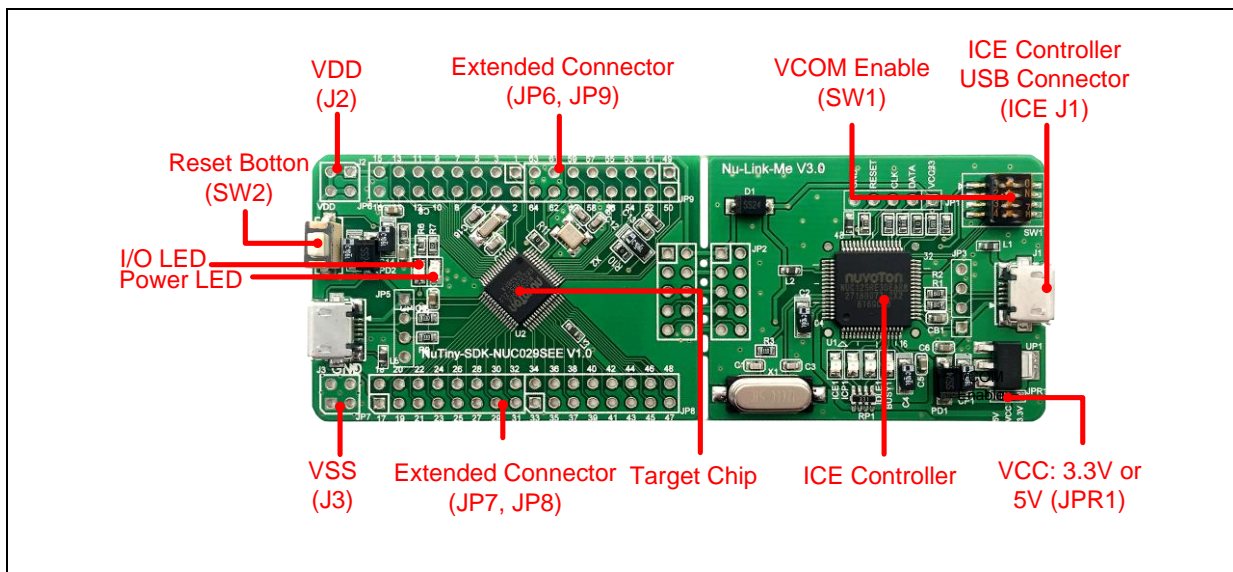

Figure 2-1 NuTiny-SDK-NUC029SEE (PCB Board)

2.1 NuTiny-SDK-NUC029SEE Jumper Description

2.1.1 Power Setting

- J1: USB port in Nu-Link-Me
- J2: V_{DD} Voltage connector in NuTiny-EVB-NUC029SEE

Model	JPR1	J1 USB port	J2 V_{DD}	MCU Voltage
Model 1	Select VCC33 (default)	Connect to PC	DC 3.3V output	DC 3.3V
Model 2	X	X	DC 2.5 V ~ 5.5 V Input	Voltage by J2 input

X: Unused.

2.1.2 Debug Connector

- **JP4:** Connector in target board (NuTiny-EVB-NUC029SEE) for connecting with Nuvoton ICE adaptor (Nu-Link-Me V3.0)
- **JP2:** Connector in ICE adaptor (Nu-Link-Me V3.0) for connecting with a target board (for example NuTiny-EVB-NUC029SEE)

2.1.3 USB Connector

- **J1:** Micro USB Connector in Nu-Link-Me V3.0 connected to a PC USB port

2.1.4 Extended Connector

- **JP6, JP7, JP8, JP9:** Show all chip pins in NuTiny-EVB-NUC029SEE

2.1.5 Reset Button

- **SW2:** Reset button in NuTiny-EVB-NUC029SEE

2.1.6 Power Connector

- **J2:** V_{DD} connector in NuTiny-EVB-NUC029SEE
- **J3:** V_{SS} connector in NuTiny-EVB-NUC029SEE

2.1.7 VCOM Enable

- **SW1:** VCOM function enable for the NuTiny-SDK-NUC029SEE. Switch SW1 on before power on to enable VCOM function. SW1 connects pin 21(PB.0/RXD) and pin 22(PB.1/TXD) in NuTiny-EVB-NUC029SEE with pin 22(PB.1/TXD) and pin 21(PB.0/RXD) in Nuvoton ICE adaptor (Nu-Link-Me V3.0). SW1 connects pin 29(VCOM) in Nuvoton ICE adaptor (Nu-Link-Me V3.0) to GND to enable VCOM function.

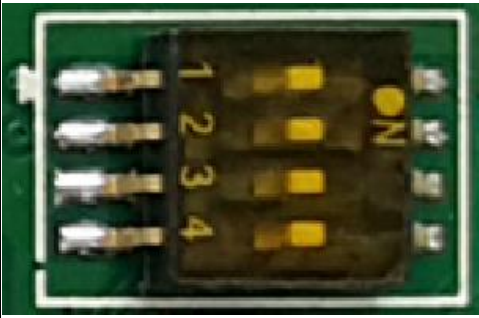
Switch Pin Number	Function Name	UART0 Mode	VCOM Mode	SW1
1	ICE_TX	Off	On	
2	ICE_RX	Off	On	
3	VCOM_EN	Off	On	
4	X	X	X	

X: Unused.

2.2 Pin Assignment for Extended Connector

The NuTiny-EVB-NUC029SEE provides NUC029SEE on board and the extended connector (JP6, JP7, JP8 and JP9) for LQFP-64 pin.

Pin No.	Pin Name	Pin Type	Description
1	PB.14	I/O	General purpose digital I/O pin.
	INT0	I	External interrupt0 input pin.
	AD0	I/O	EBI Address/Data bus bit0
2	PB.13	I/O	General purpose digital I/O pin.
	AD1	I/O	EBI Address/Data bus bit1
3	V _{BAT}	P	Power supply by batteries for RTC.
4	X32_OUT	O	External 32.768 kHz (low speed) crystal output pin.
5	X32_IN	I	External 32.768 kHz (low speed) crystal input pin.
6	PA.11	I/O	General purpose digital I/O pin.
	I2C1_SCL	I/O	I ² C1 clock pin.
	nRD	O	EBI read enable output pin
7	PA.10	I/O	General purpose digital I/O pin.
	I2C1_SDA	I/O	I ² C1 data input/output pin.
	nWR	O	EBI write enable output pin
8	PA.9	I/O	General purpose digital I/O pin.
	I2C0_SCL	I/O	I ² C0 clock pin.
9	PA.8	I/O	General purpose digital I/O pin.
	I2C0_SDA	I/O	I ² C0 data input/output pin.
10	PB.4	I/O	General purpose digital I/O pin.
	UART1_RXD	I	Data receiver input pin for UART1.
11	PB.5	I/O	General purpose digital I/O pin.
	UART1_TXD	O	Data transmitter output pin for UART1.
12	PB.6	I/O	General purpose digital I/O pin.
	UART1_nRTS	O	Request to Send output pin for UART1.
	ALE	O	EBI address latch enable output pin
13	PB.7	I/O	General purpose digital I/O pin.
	UART1_nCTS	I	Clear to Send input pin for UART1.
	nCS	O	EBI chip select enable output pin
14	LDO_CAP	P	LDO output pin.
15	V _{DD}	P	Power supply for I/O ports and LDO source for internal PLL and digital circuit.

Pin No.	Pin Name	Pin Type	Description
16	V _{SS}	P	Ground pin for digital circuit.
17	USB_VBUS	USB	Power supply from USB host or HUB.
18	USB_VDD33_CAP	USB	Internal power regulator output 3.3V decoupling pin.
19	USB_D-	USB	USB differential signal D-.
20	USB_D+	USB	USB differential signal D+.
21	PB.0	I/O	General purpose digital I/O pin.
	UART0_RXD	I	Data receiver input pin for UART0.
22	PB.1	I/O	General purpose digital I/O pin.
	UART0_TXD	O	Data transmitter output pin for UART0.
23	PB.2	I/O	General purpose digital I/O pin.
	UART0_nRTS	O	Request to Send output pin for UART0.
	TM2_EXT	I	Timer2 external capture input pin.
	TM2	O	Timer2 toggle output pin.
	nWRL	O	EBI low byte write enable output pin
24	PB.3	I/O	General purpose digital I/O pin.
	UART0_nCTS	I	Clear to Send input pin for UART0.
	TM3_EXT	I	Timer3 external capture input pin.
	TM3	O	Timer3 toggle output pin.
	nWRH	O	EBI high byte write enable output pin
25	PC.3	I/O	General purpose digital I/O pin.
	SPI0_MOSI0	I/O	1 st SPI0 MOSI (Master Out, Slave In) pin.
26	PC.2	I/O	General purpose digital I/O pin.
	SPI0_MISO0	I/O	1 st SPI0 MISO (Master In, Slave Out) pin.
27	PC.1	I/O	General purpose digital I/O pin.
	SPI0_CLK	I/O	SPI0 serial clock pin.
28	PC.0	I/O	General purpose digital I/O pin.
	SPI0_SS0	I/O	1 st SPI0 slave select pin.
29	PE.5	I/O	General purpose digital I/O pin.
	PWM5	I/O	PWM5 output/Capture input.
	TM1_EXT	I	Timer1 external capture input pin.
	TM1	O	Timer1 toggle output pin.

Pin No.	Pin Name	Pin Type	Description
30	PB.11	I/O	General purpose digital I/O pin.
	TM3	I/O	Timer3 event counter input / toggle output.
	PWM4	I/O	PWM4 output/Capture input.
31	PB.10	I/O	General purpose digital I/O pin.
	TM2	I/O	Timer2 event counter input / toggle output.
	UART2_RXD	I	Data receiver input pin for UART2.
32	PB.9	I/O	General purpose digital I/O pin.
	TM1	I/O	Timer1 event counter input / toggle output.
	UART2_TXD	O	Data transmitter output pin for UART2.
33	PC.11	I/O	General purpose digital I/O pin.
	SPI1_MOSI0	I/O	1 st SPI1 MOSI (Master Out, Slave In) pin.
34	PC.10	I/O	General purpose digital I/O pin.
	SPI1_MISO0	I/O	1 st SPI1 MISO (Master In, Slave Out) pin.
35	PC.9	I/O	General purpose digital I/O pin.
	SPI1_CLK	I/O	SPI1 serial clock pin.
36	PC.8	I/O	General purpose digital I/O pin.
	SPI1_SS0	I/O	1 st SPI1 slave select pin.
	MCLK	O	EBI clock output
37	PA.15	I/O	General purpose digital I/O pin.
	PWM3	I/O	PWM3 output/Capture input.
38	PA.14	I/O	General purpose digital I/O pin.
	PWM2	I/O	PWM2 output/Capture input.
	AD15	I/O	EBI Address/Data bus bit15
39	PA.13	I/O	General purpose digital I/O pin.
	PWM1	I/O	PWM1 output/Capture input.
	AD14	I/O	EBI Address/Data bus bit14
40	PA.12	I/O	General purpose digital I/O pin.
	PWM0	I/O	PWM0 output/Capture input.
	AD13	I/O	EBI Address/Data bus bit13
41	ICE_DAT	I/O	Serial wire debugger data pin.
42	ICE_CLK	I	Serial wire debugger clock pin.
43	AV _{SS}	AP	Ground pin for analog circuit.

Pin No.	Pin Name	Pin Type	Description
44	PA.0	I/O	General purpose digital I/O pin.
	ADC0	AI	ADC0 analog input.
45	PA.1	I/O	General purpose digital I/O pin.
	ADC1	AI	ADC1 analog input.
	AD12	I/O	EBI Address/Data bus bit12
46	PA.2	I/O	General purpose digital I/O pin.
	ADC2	AI	ADC2 analog input.
	AD11	I/O	EBI Address/Data bus bit11
47	PA.3	I/O	General purpose digital I/O pin.
	ADC3	AI	ADC3 analog input.
	AD10	I/O	EBI Address/Data bus bit10
48	PA.4	I/O	General purpose digital I/O pin.
	ADC4	AI	ADC4 analog input.
	AD9	I/O	EBI Address/Data bus bit9
49	PA.5	I/O	General purpose digital I/O pin.
	ADC5	AI	ADC5 analog input.
	AD8	I/O	EBI Address/Data bus bit8
50	PA.6	I/O	General purpose digital I/O pin.
	ADC6	AI	ADC6 analog input.
	AD7	I/O	EBI Address/Data bus bit7
51	V _{REF}	AP	Voltage reference input for ADC.
52	AV _{DD}	AP	Power supply for internal analog circuit.
53	PC.7	I/O	General purpose digital I/O pin.
	ADC7	AI	ADC7 analog input.
	AD5	I/O	EBI Address/Data bus bit5
54	PC.6	I/O	General purpose digital I/O pin.
	ADC8	AI	ADC8 analog input.
	AD4	I/O	EBI Address/Data bus bit4
55	PC.15	I/O	General purpose digital I/O pin.
	ADC9	AI	ADC9 analog input.
	AD3	I/O	EBI Address/Data bus bit3
56	PC.14	I/O	General purpose digital I/O pin.

Pin No.	Pin Name	Pin Type	Description
	ADC10	AI	ADC10 analog input.
	AD2	I/O	EBI Address/Data bus bit2
57	PB.15	I/O	General purpose digital I/O pin.
	INT1	I	External interrupt1 input pin.
	TM0_EXT	I	Timer 0 external capture input pin.
	TM0	I/O	Timer0 event counter input / toggle output.
	ADC11	AI	ADC11 analog input.
	AD6	I/O	EBI Address/Data bus bit6
58	PF.0	I/O	General purpose digital I/O pin.
	XT1_OUT	O	External 4~24 MHz (high speed) crystal output pin.
59	PF.1	I/O	General purpose digital I/O pin.
	XT1_IN	I	External 4~24 MHz (high speed) crystal input pin.
60	nRESET	I	External reset input: active LOW, with an internal pull-up. Set this pin low reset chip to initial state.
61	V _{SS}	P	Ground pin for digital circuit.
62	V _{DD}	P	Power supply for I/O ports and LDO source for internal PLL and digital circuit.
63	PV _{SS}	P	PLL ground.
64	PB.8	I/O	General purpose digital I/O pin.
	STADC	I	ADC external trigger input.
	TM0	I/O	Timer0 event counter input / toggle output.
	CLKO	O	Frequency divider clock output pin.

Note: Pin Type I = Digital Input, O = Digital Output; AI = Analog Input; P = Power Pin; AP = Analog Power

Table 2-1 is the pin assignment for NUC029SEE.

Pin No.	Pin Name	Pin Type	Description
1	PB.14	I/O	General purpose digital I/O pin.
	INT0	I	External interrupt0 input pin.
	AD0	I/O	EBI Address/Data bus bit0
2	PB.13	I/O	General purpose digital I/O pin.
	AD1	I/O	EBI Address/Data bus bit1
3	V _{BAT}	P	Power supply by batteries for RTC.
4	X32_OUT	O	External 32.768 kHz (low speed) crystal output pin.

Pin No.	Pin Name	Pin Type	Description
5	X32_IN	I	External 32.768 kHz (low speed) crystal input pin.
6	PA.11	I/O	General purpose digital I/O pin.
	I2C1_SCL	I/O	I ² C1 clock pin.
	nRD	O	EBI read enable output pin
7	PA.10	I/O	General purpose digital I/O pin.
	I2C1_SDA	I/O	I ² C1 data input/output pin.
	nWR	O	EBI write enable output pin
8	PA.9	I/O	General purpose digital I/O pin.
	I2C0_SCL	I/O	I ² C0 clock pin.
9	PA.8	I/O	General purpose digital I/O pin.
	I2C0_SDA	I/O	I ² C0 data input/output pin.
10	PB.4	I/O	General purpose digital I/O pin.
	UART1_RXD	I	Data receiver input pin for UART1.
11	PB.5	I/O	General purpose digital I/O pin.
	UART1_TXD	O	Data transmitter output pin for UART1.
12	PB.6	I/O	General purpose digital I/O pin.
	UART1_nRTS	O	Request to Send output pin for UART1.
	ALE	O	EBI address latch enable output pin
13	PB.7	I/O	General purpose digital I/O pin.
	UART1_nCTS	I	Clear to Send input pin for UART1.
	nCS	O	EBI chip select enable output pin
14	LDO_CAP	P	LDO output pin.
15	V _{DD}	P	Power supply for I/O ports and LDO source for internal PLL and digital circuit.
16	V _{SS}	P	Ground pin for digital circuit.
17	USB_VBUS	USB	Power supply from USB host or HUB.
18	USB_VDD33_CAP	USB	Internal power regulator output 3.3V decoupling pin.
19	USB_D-	USB	USB differential signal D-.
20	USB_D+	USB	USB differential signal D+.
21	PB.0	I/O	General purpose digital I/O pin.
	UART0_RXD	I	Data receiver input pin for UART0.
22	PB.1	I/O	General purpose digital I/O pin.
	UART0_TXD	O	Data transmitter output pin for UART0.

Pin No.	Pin Name	Pin Type	Description
23	PB.2	I/O	General purpose digital I/O pin.
	UART0_nRTS	O	Request to Send output pin for UART0.
	TM2_EXT	I	Timer2 external capture input pin.
	TM2	O	Timer2 toggle output pin.
	nWRL	O	EBI low byte write enable output pin
24	PB.3	I/O	General purpose digital I/O pin.
	UART0_nCTS	I	Clear to Send input pin for UART0.
	TM3_EXT	I	Timer3 external capture input pin.
	TM3	O	Timer3 toggle output pin.
	nWRH	O	EBI high byte write enable output pin
25	PC.3	I/O	General purpose digital I/O pin.
	SPI0_MOSI0	I/O	1 st SPI0 MOSI (Master Out, Slave In) pin.
26	PC.2	I/O	General purpose digital I/O pin.
	SPI0_MISO0	I/O	1 st SPI0 MISO (Master In, Slave Out) pin.
27	PC.1	I/O	General purpose digital I/O pin.
	SPI0_CLK	I/O	SPI0 serial clock pin.
28	PC.0	I/O	General purpose digital I/O pin.
	SPI0_SS0	I/O	1 st SPI0 slave select pin.
29	PE.5	I/O	General purpose digital I/O pin.
	PWM5	I/O	PWM5 output/Capture input.
	TM1_EXT	I	Timer1 external capture input pin.
	TM1	O	Timer1 toggle output pin.
30	PB.11	I/O	General purpose digital I/O pin.
	TM3	I/O	Timer3 event counter input / toggle output.
	PWM4	I/O	PWM4 output/Capture input.
31	PB.10	I/O	General purpose digital I/O pin.
	TM2	I/O	Timer2 event counter input / toggle output.
	UART2_RXD	I	Data receiver input pin for UART2.
32	PB.9	I/O	General purpose digital I/O pin.
	TM1	I/O	Timer1 event counter input / toggle output.
	UART2_TXD	O	Data transmitter output pin for UART2.
33	PC.11	I/O	General purpose digital I/O pin.

Pin No.	Pin Name	Pin Type	Description
	SPI1_MOSI0	I/O	1 st SPI1 MOSI (Master Out, Slave In) pin.
34	PC.10	I/O	General purpose digital I/O pin.
	SPI1_MISO0	I/O	1 st SPI1 MISO (Master In, Slave Out) pin.
35	PC.9	I/O	General purpose digital I/O pin.
	SPI1_CLK	I/O	SPI1 serial clock pin.
36	PC.8	I/O	General purpose digital I/O pin.
	SPI1_SS0	I/O	1 st SPI1 slave select pin.
	MCLK	O	EBI clock output
37	PA.15	I/O	General purpose digital I/O pin.
	PWM3	I/O	PWM3 output/Capture input.
38	PA.14	I/O	General purpose digital I/O pin.
	PWM2	I/O	PWM2 output/Capture input.
	AD15	I/O	EBI Address/Data bus bit15
39	PA.13	I/O	General purpose digital I/O pin.
	PWM1	I/O	PWM1 output/Capture input.
	AD14	I/O	EBI Address/Data bus bit14
40	PA.12	I/O	General purpose digital I/O pin.
	PWM0	I/O	PWM0 output/Capture input.
	AD13	I/O	EBI Address/Data bus bit13
41	ICE_DAT	I/O	Serial wire debugger data pin.
42	ICE_CLK	I	Serial wire debugger clock pin.
43	AV _{ss}	AP	Ground pin for analog circuit.
44	PA.0	I/O	General purpose digital I/O pin.
	ADC0	AI	ADC0 analog input.
45	PA.1	I/O	General purpose digital I/O pin.
	ADC1	AI	ADC1 analog input.
	AD12	I/O	EBI Address/Data bus bit12
46	PA.2	I/O	General purpose digital I/O pin.
	ADC2	AI	ADC2 analog input.
	AD11	I/O	EBI Address/Data bus bit11
47	PA.3	I/O	General purpose digital I/O pin.
	ADC3	AI	ADC3 analog input.

Pin No.	Pin Name	Pin Type	Description
	AD10	I/O	EBI Address/Data bus bit10
48	PA.4	I/O	General purpose digital I/O pin.
	ADC4	AI	ADC4 analog input.
	AD9	I/O	EBI Address/Data bus bit9
49	PA.5	I/O	General purpose digital I/O pin.
	ADC5	AI	ADC5 analog input.
	AD8	I/O	EBI Address/Data bus bit8
50	PA.6	I/O	General purpose digital I/O pin.
	ADC6	AI	ADC6 analog input.
	AD7	I/O	EBI Address/Data bus bit7
51	V _{REF}	AP	Voltage reference input for ADC.
52	AV _{DD}	AP	Power supply for internal analog circuit.
53	PC.7	I/O	General purpose digital I/O pin.
	ADC7	AI	ADC7 analog input.
	AD5	I/O	EBI Address/Data bus bit5
54	PC.6	I/O	General purpose digital I/O pin.
	ADC8	AI	ADC8 analog input.
	AD4	I/O	EBI Address/Data bus bit4
55	PC.15	I/O	General purpose digital I/O pin.
	ADC9	AI	ADC9 analog input.
	AD3	I/O	EBI Address/Data bus bit3
56	PC.14	I/O	General purpose digital I/O pin.
	ADC10	AI	ADC10 analog input.
	AD2	I/O	EBI Address/Data bus bit2
57	PB.15	I/O	General purpose digital I/O pin.
	INT1	I	External interrupt1 input pin.
	TM0_EXT	I	Timer 0 external capture input pin.
	TM0	I/O	Timer0 event counter input / toggle output.
	ADC11	AI	ADC11 analog input.
	AD6	I/O	EBI Address/Data bus bit6
58	PF.0	I/O	General purpose digital I/O pin.
	XT1_OUT	O	External 4~24 MHz (high speed) crystal output pin.

Pin No.	Pin Name	Pin Type	Description
59	PF.1	I/O	General purpose digital I/O pin.
	XT1_IN	I	External 4~24 MHz (high speed) crystal input pin.
60	nRESET	I	External reset input: active LOW, with an internal pull-up. Set this pin low reset chip to initial state.
61	V _{SS}	P	Ground pin for digital circuit.
62	V _{DD}	P	Power supply for I/O ports and LDO source for internal PLL and digital circuit.
63	PV _{SS}	P	PLL ground.
64	PB.8	I/O	General purpose digital I/O pin.
	STADC	I	ADC external trigger input.
	TM0	I/O	Timer0 event counter input / toggle output.
	CLKO	O	Frequency divider clock output pin.

Note: Pin Type I = Digital Input, O = Digital Output; AI = Analog Input; P = Power Pin; AP = Analog Power

Table 2-1 Pin Assignment for NUC029SEE

2.3 NuTiny-SDK-NUC029SEE PCB Placement

Figure 2-2 shows the NuTiny-SDK-NUC029SEE PCB placement.

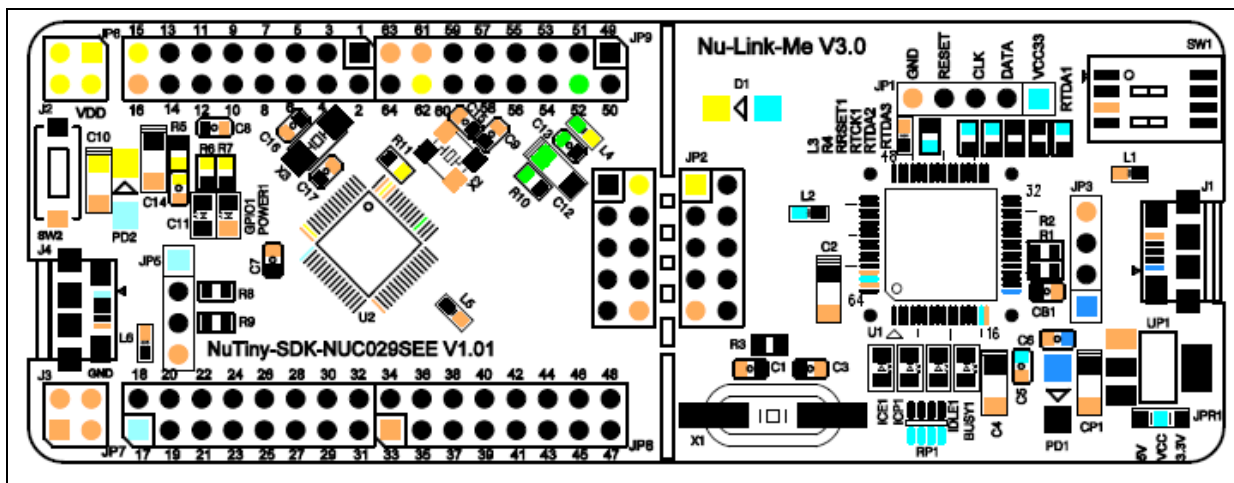

Figure 2-2 NuTiny-SDK-NUC029SEE PCB Placement

3 HOW TO START NUTINY-SDK-NUC029SEE ON THE KEIL MDK ENVIRONMENT

3.1 Downloading and Installing Keil MDK Software

Please visit the Keil company website (<http://www.keil.com>) to download and install the Keil MDK.

3.2 Downloading and Installing Nuvoton Nu-Link Driver

Please visit the official Nuvoton NuMicro® website (<http://www.nuvoton.com/NuMicro>) to download “NuMicro® Keil μVision® IDE driver” file. When the Nu-Link driver has been well downloaded, please unzip the file and execute the “Nu-Link_Keil_Driver.exe” to install the driver.

3.3 Hardware Setup

The hardware setup is shown as Figure 3-1.

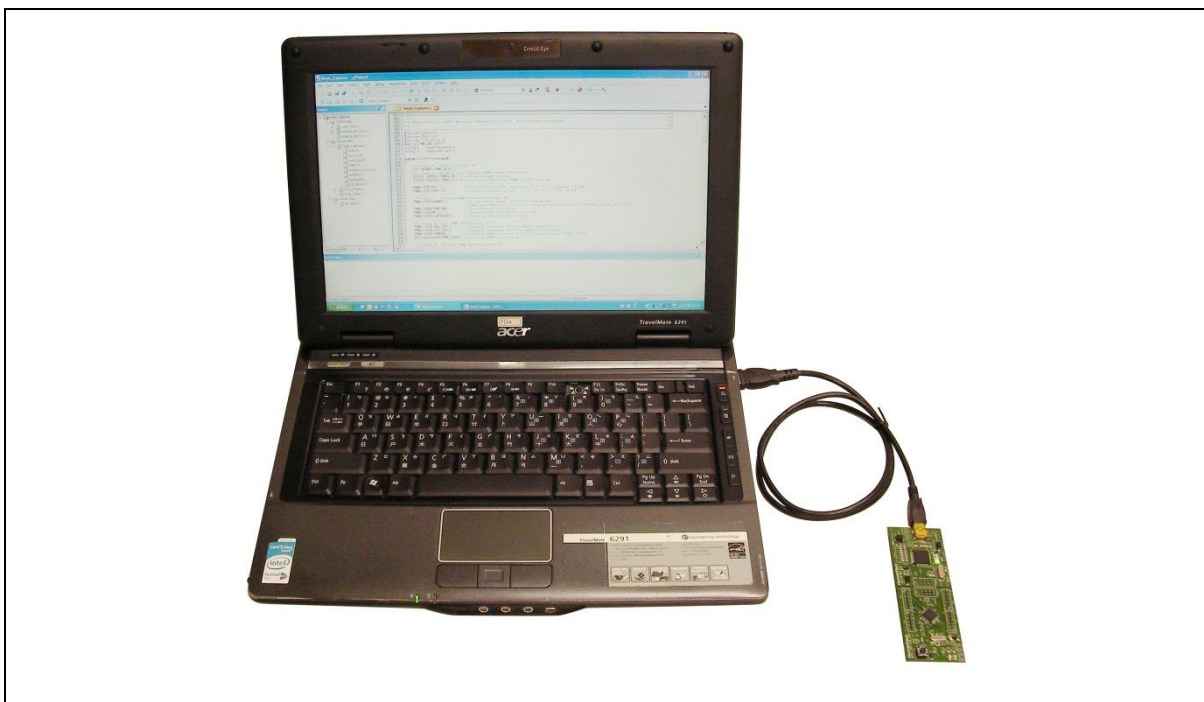









Figure 3-1 NuTiny-SDK-NUC029SEE Hardware Setup

3.4 Example Program

This example demonstrates downloading and debugging an application on a NuTiny-SDK-NUC029SEE board. It can be found on the list directory and downloaded from Nuvoton NuMicro® website.

Directory	..\NUC029xEE_BSP_v3.00.001\SampleCode\Template\Keil
------------------	---

This sample code will show some functions about system manager controller and clock controller.

-  Start uVision®
- Project – Open
Open the SYS.uvproj project file
-  Project – Build
Compile and link the SYS application
-  Flash – Download
Program the application code into on-chip Flash ROM
-  Start debug mode
When using the debugger commands, you may:
 - ◆  Review variables in the watch window
 - ◆  Single step through code
 - ◆  Reset the device
 - ◆  Run the application

4 HOW TO START NUTINY-SDK-NUC029SEE ON THE IAR EMBEDDED WORKBENCH

4.1 Downloading and Installing IAR Embedded Workbench Software

Please connect to IAR company website (<http://www.iar.com>) to download the IAR Embedded Workbench and install the EWARM.

4.2 Downloading and Installing Nuvoton Nu-Link Driver

Please visit the official Nuvoton NuMicro® website (<http://www.nuvoton.com/NuMicro>) to download the “NuMicro® IAR EWARM Driver” file. When the Nu-Link driver has been well downloaded, please unzip the file and execute the “Nu-Link_Keil_Driver.exe” to install the driver.

4.3 Hardware Setup

The hardware setup is shown as Figure 4-1.

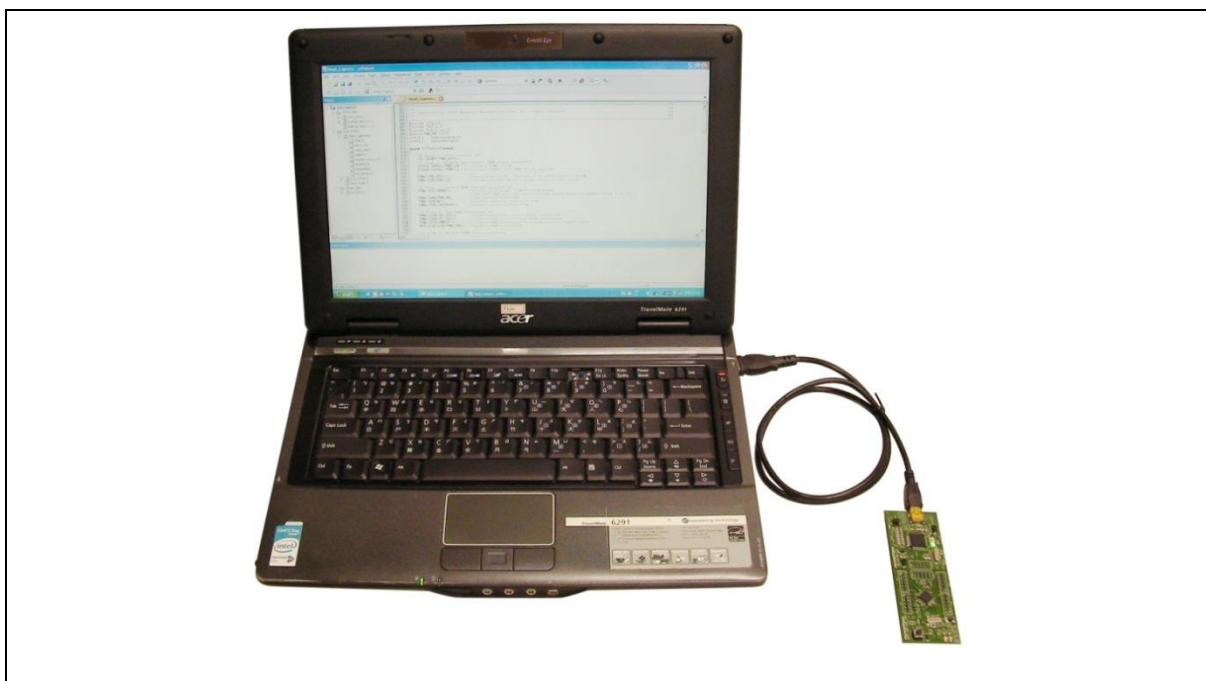







Figure 4-1 NuTiny-SDK-NUC029SEE Hardware Setup

4.4 Example Program

This example demonstrates downloading and debugging an application on a NuTiny-SDK-NUC029SEE board. It can be found on the list directory and downloaded from Nuvoton NuMicro® website.

Directory	..\NUC029xEE_BSP_v3.00.001\SampleCode\Template\IAR
------------------	--

This sample code will show some functions about system manager controller and clock controller.

-  Start IAR Embedded Workbench
-  Project – Download and Debug
Program the application code into on-chip Flash ROM
- File-Open-Workspace
Open the SYS.eww workspace file
-  Single step through code
-  Reset the device
-  Project - Make
Compile and link the SYS application
-  Run the application

5 STARTING TO USE NU-LINK-ME 3.0 VCOM FUNCTION

5.1 Downloading and Installing VCOM Driver

Please connect to Nuvoton NuMicro® website (<http://www.nuvoton.com/NuMicro>) to download the “NuMicro® ICP Programming Tool” file. After the ICP Programming Tool driver is downloaded, please unzip the file and execute the “ICP Programming Tool.exe”. Simply follow the installation and optional steps to install ICP Programming Tool and Nu-Link USB Driver, which included VCOM driver.

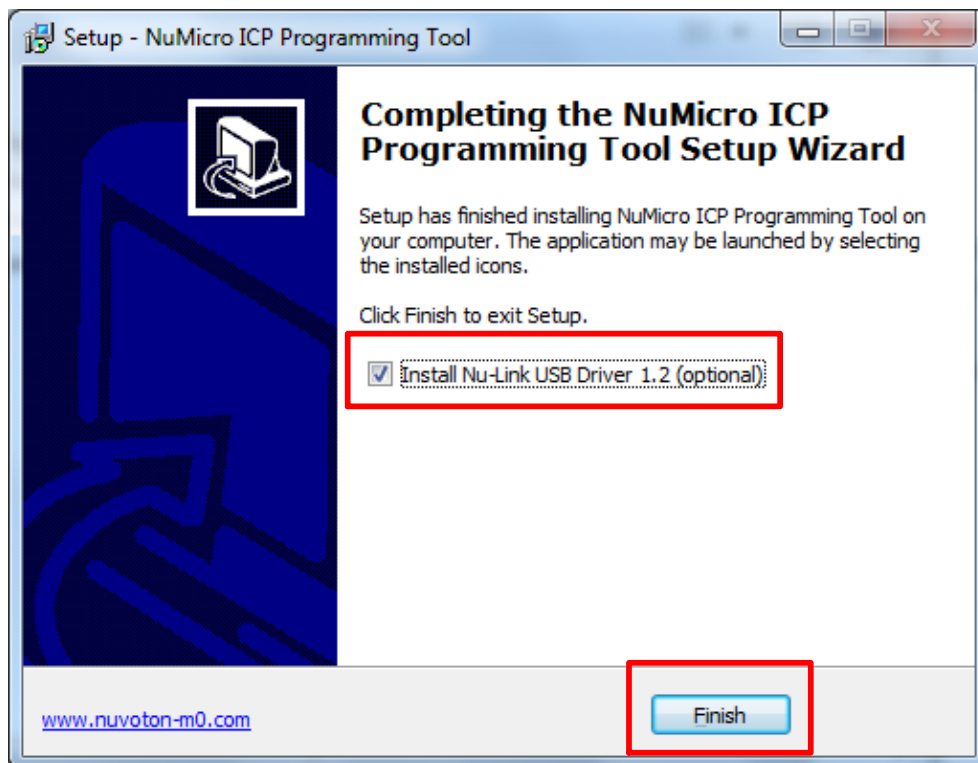

Figure 5-1 Optional Step after ICP Programming Tool Installation

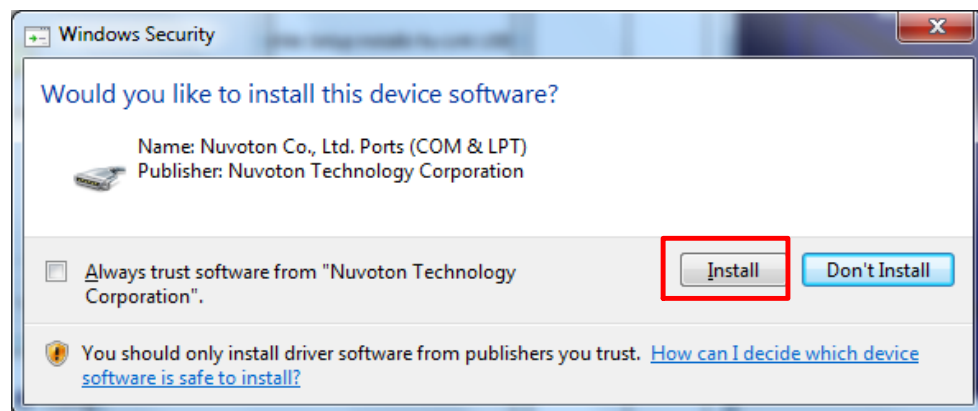

Figure 5-2 Install Nuvoton COM&LPT Driver

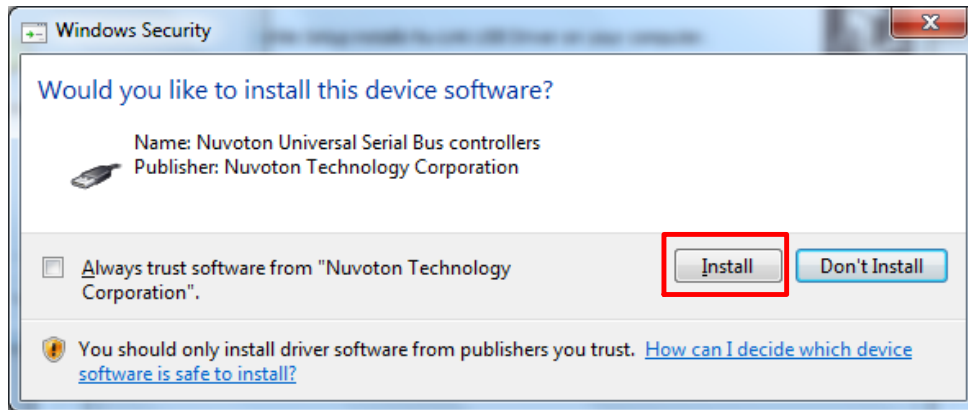

Figure 5-3 Install Nuvoton Universal Serial Bus Controllers

5.2 VCOM Mode Setting on NuTiny-SDK-NUC029SEE

Before the NuTiny-SDK-NUC029SEE is connected to the PC, please enable VCOM function by switching on SW1. The NuTiny-EVB-NUC029SEE transmits through UART0 to VCOM to send out data. Switch SW1 off when using UART0 function without VCOM function.

5.3 Development Tool Setup

The example is demonstrated on the Keil μ Vision[®] IDE.

5.3.1 Check the Using UART on the Keil μ Vision[®] IDE

Please open the project and find system_NUC029xEE.h to check the using UART in DEBUG_PORT, which has to be the same as the using UART in the NuTiny-EVB-NUC029SEE.

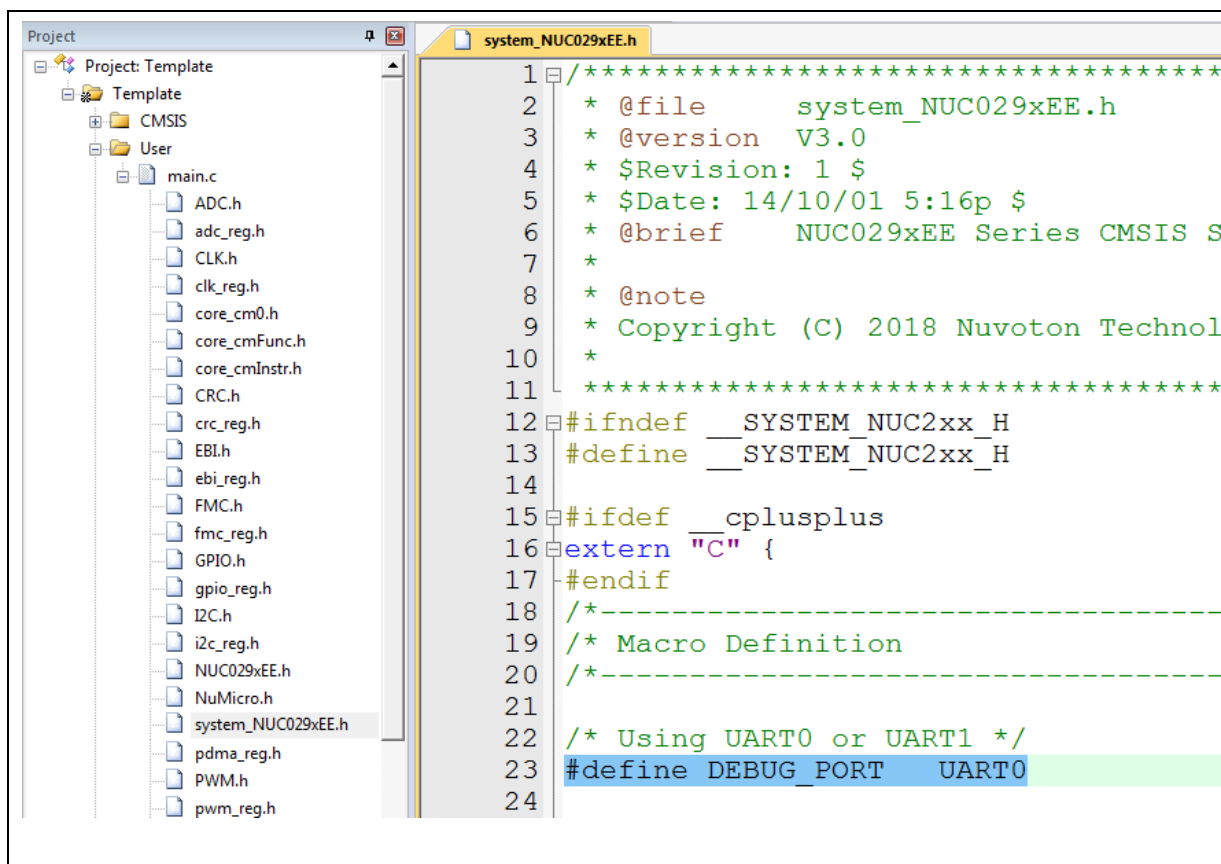
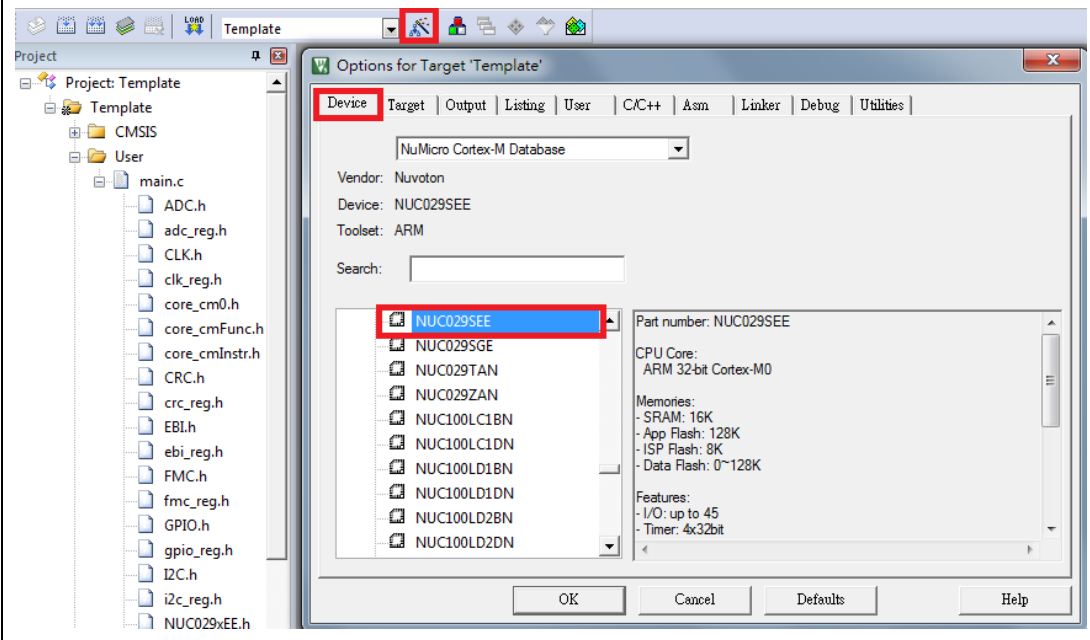

Figure 5-4 Using UART on Keil μ Vision[®] IDE

5.3.2 Check the Target Device and Debug Setting

The target device has to be the same as the setting in Debug. Please click “Target Option” to open the Option windows, and find the setting in “Device”, “Debug”, and “Utilities” page. Please follow the steps below to check the setting.

Step 1



Step 2

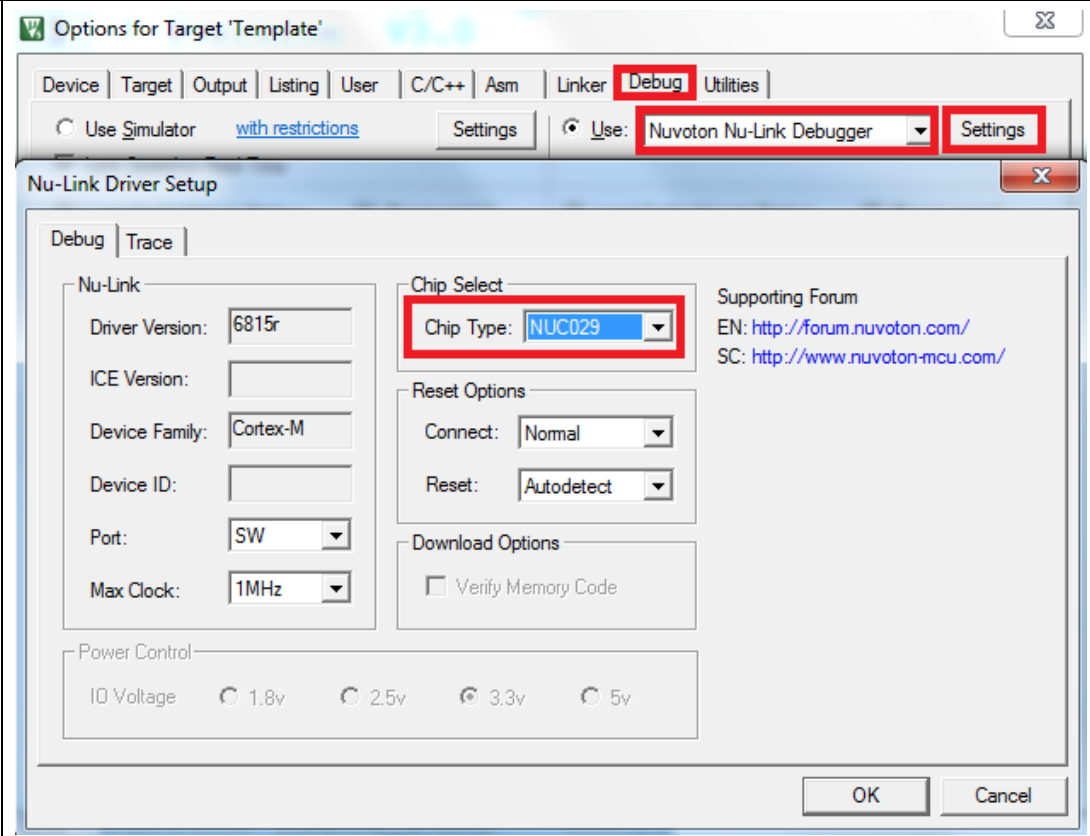

Step 3

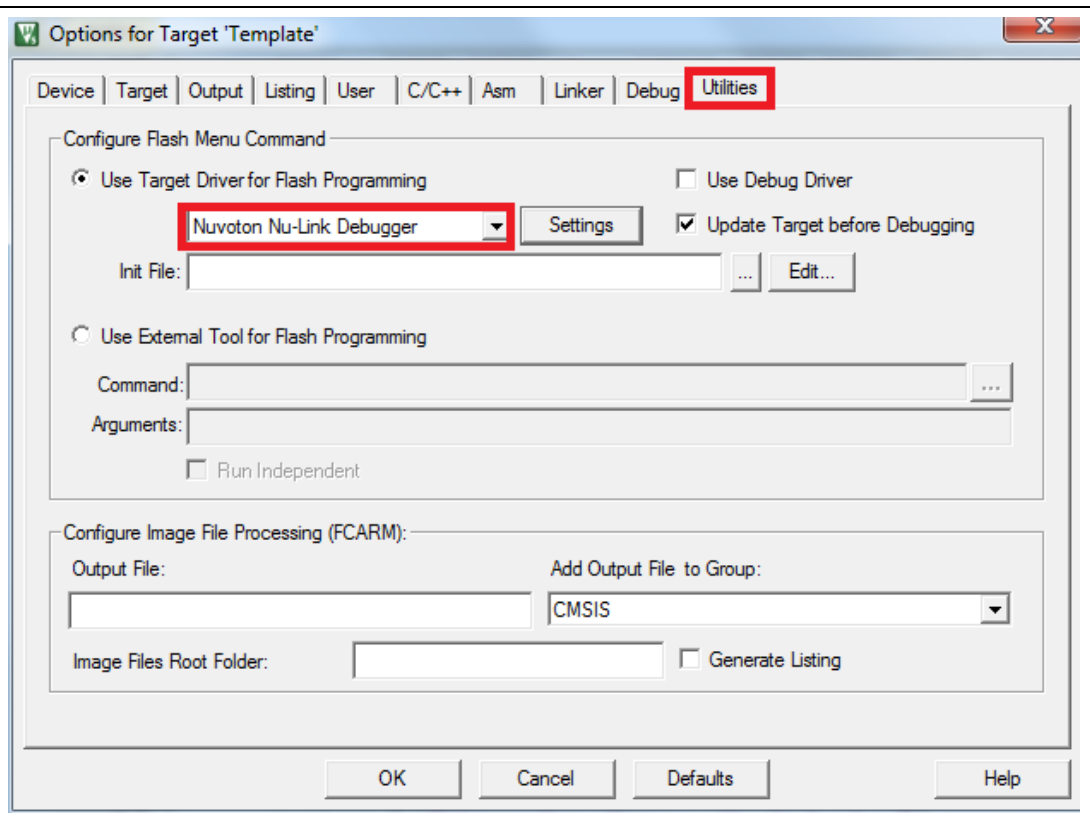

5.3.3 Build and Download Code to NuTiny-SDK-NUC029SEE

Please build the project and download code to the NuTiny-SDK-NUC029SEE.

5.3.4 Open the Serial Port Terminal

User can use serial port terminal, PuTTY for example, to print out debug message.

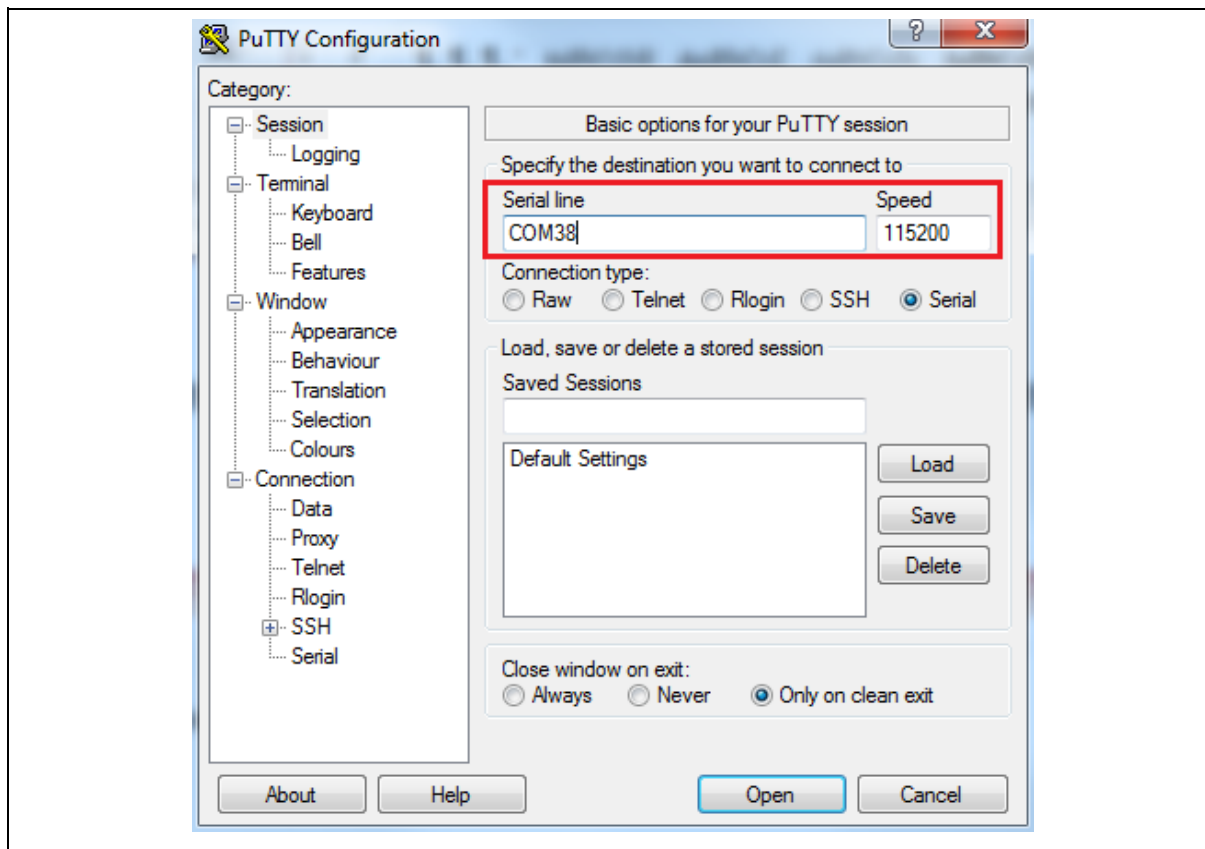

Figure 5-5 Set Baud Rate

5.3.5 Reset Chip

After pushing the reset button, the chip will reprogram application and print out debug message.

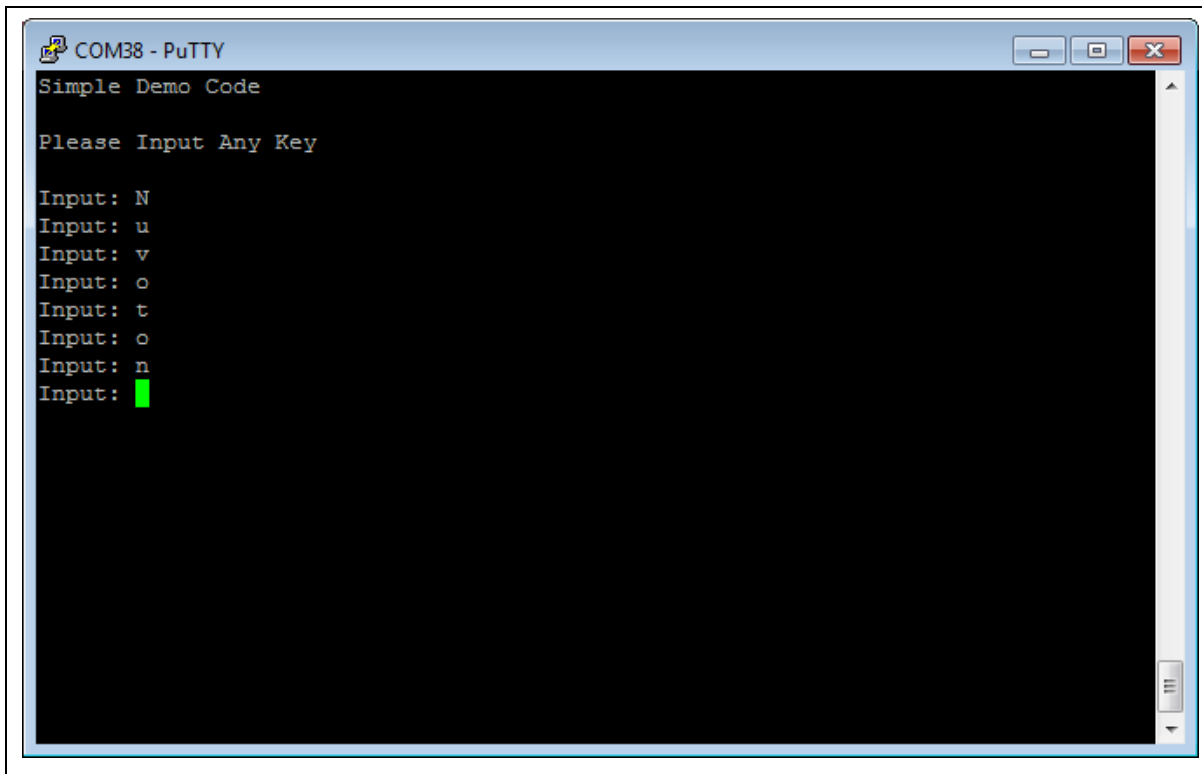
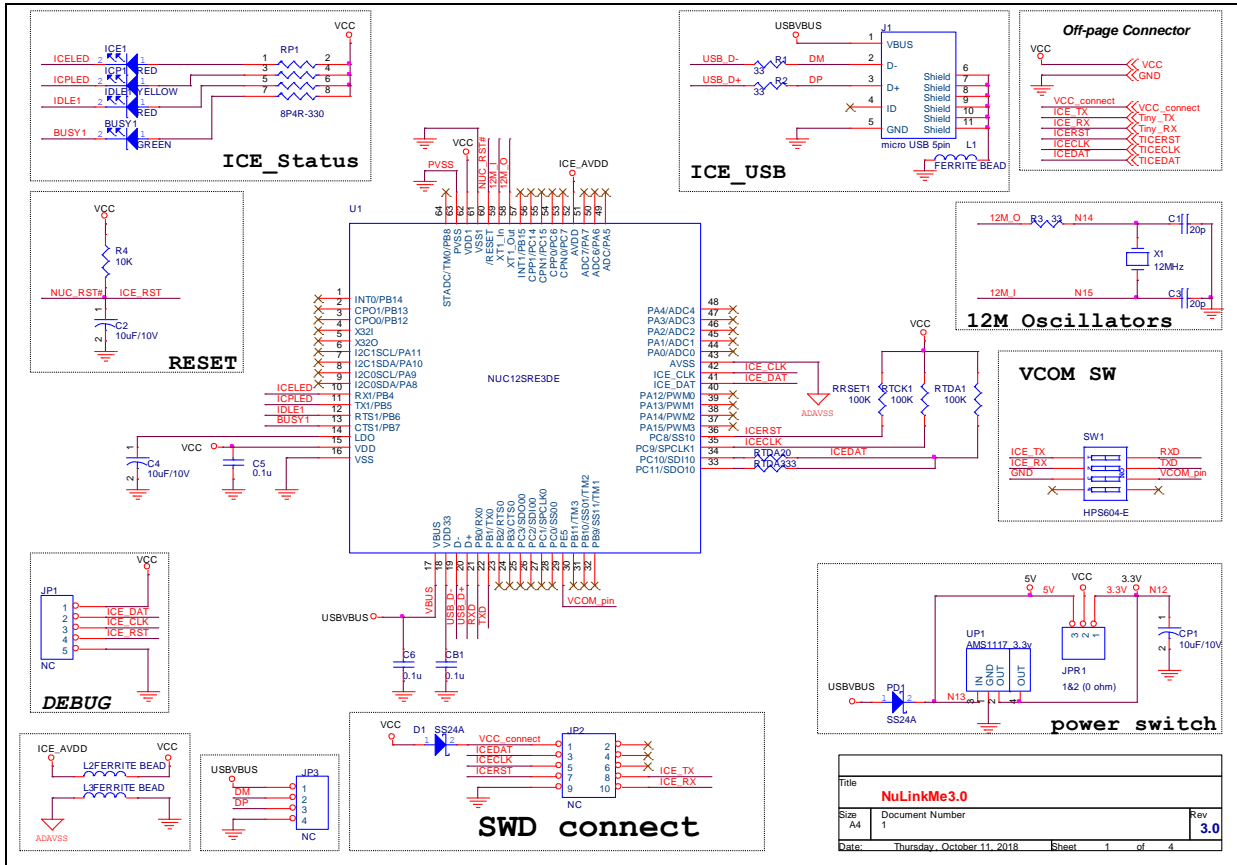

Figure 5-6 Serial Port Terminal Windows

Note: Please switch SW1 on before the NuTiny-SDK-NUC029SEE is connected to the PC. When the NuTiny-SDK-NUC029SEE is connected to the PC with SW1 switch on, PC will detect VCOM as a USB device and the detection will only be processed once. VCOM will not function if SW1 switched on after the connection.

6 NUTINY-SDK-NUC029SEE SCHEMATICS

6.1 Nu-Link-Me V3.0 Schematic



6.2 GPIO for 64 pin Schematic

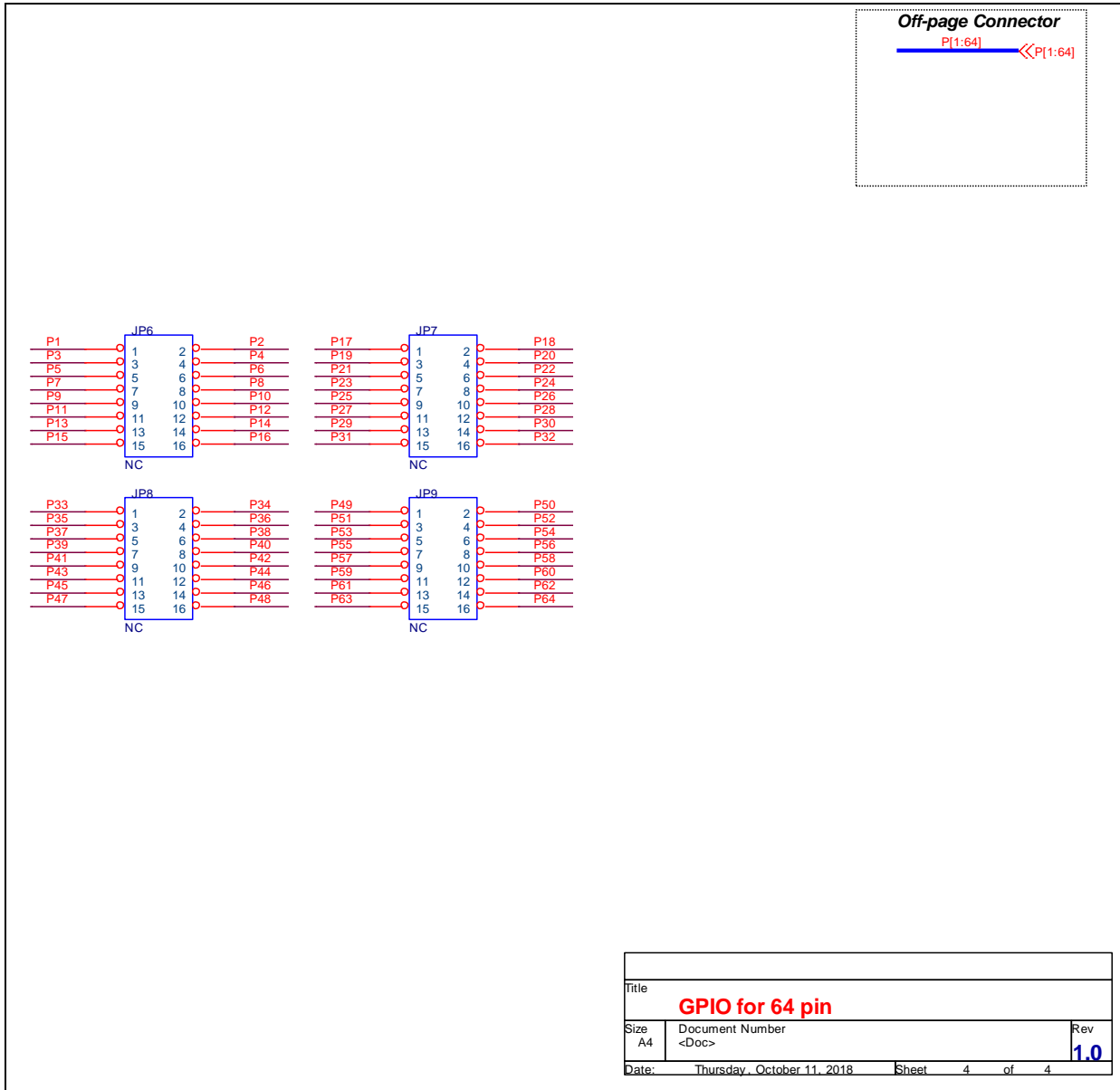

6.3 SDK Circuit Schematic

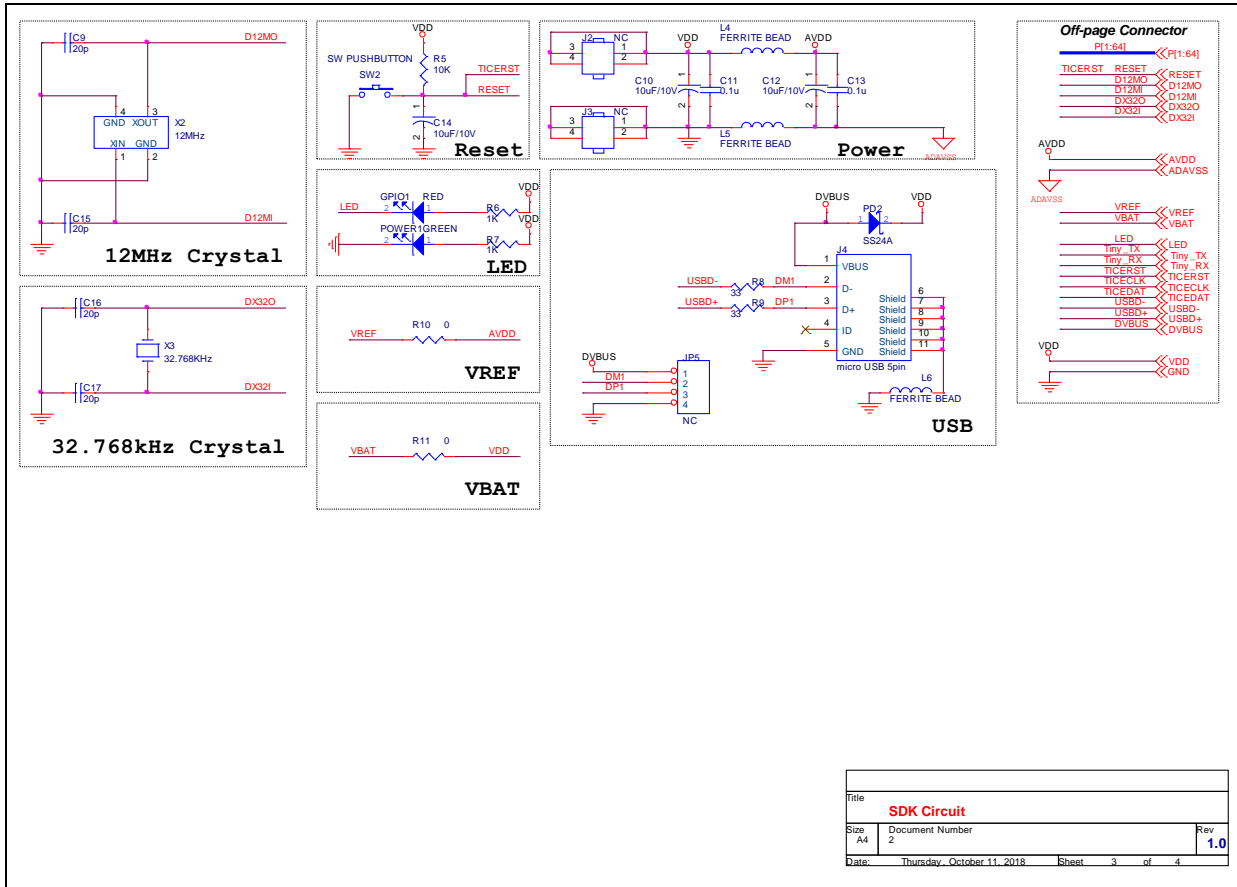

6.4 Target Chip

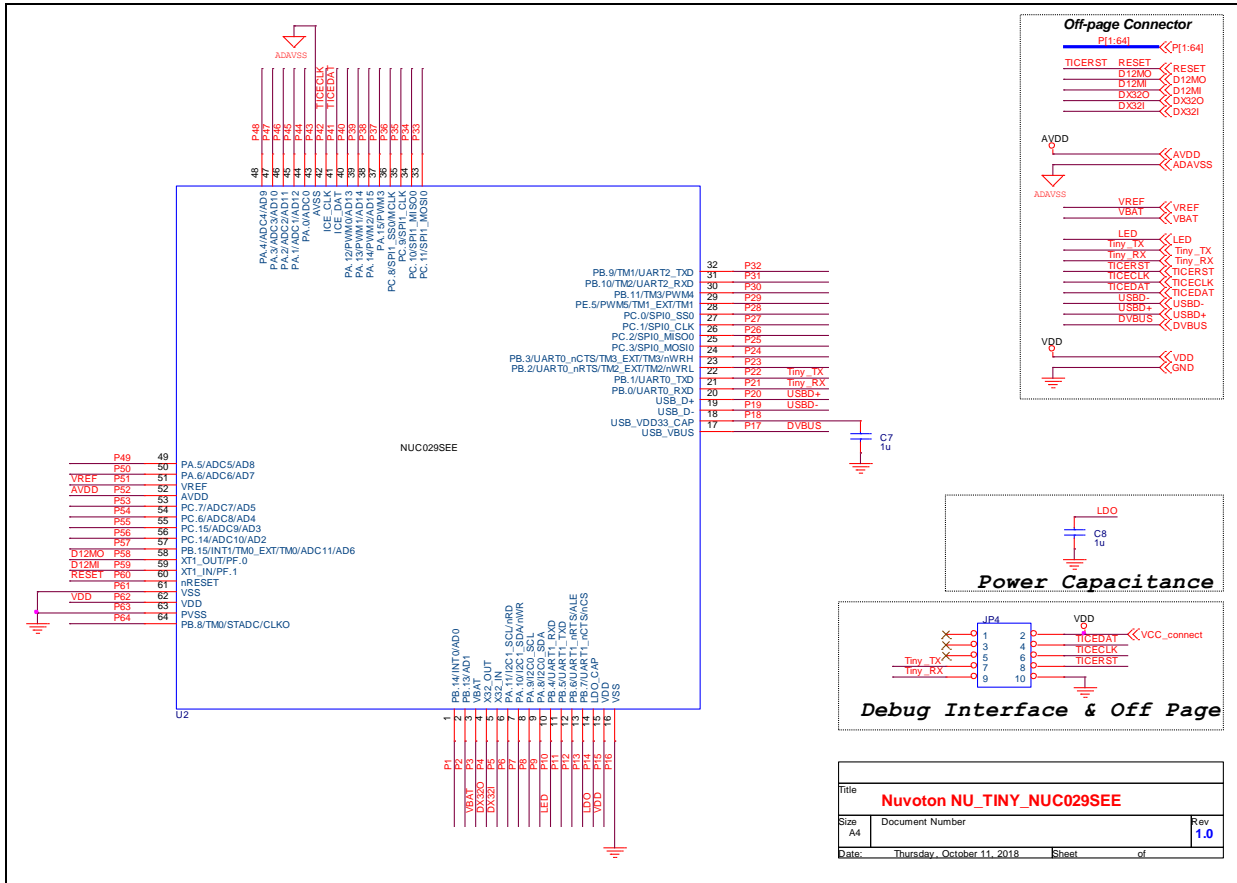

7 REVISION HISTORY

Date	Revision	Description
2019.01.21	1.00	1. Initially issued.

Important Notice

Nuvoton Products are neither intended nor warranted for usage in systems or equipment, any malfunction or failure of which may cause loss of human life, bodily injury or severe property damage. Such applications are deemed, "Insecure Usage".

Insecure usage includes, but is not limited to: equipment for surgical implementation, atomic energy control instruments, airplane or spaceship instruments, the control or operation of dynamic, brake or safety systems designed for vehicular use, traffic signal instruments, all types of safety devices, and other applications intended to support or sustain life.

All Insecure Usage shall be made at customer's risk, and in the event that third parties lay claims to Nuvoton as a result of customer's Insecure Usage, customer shall indemnify the damages and liabilities thus incurred by Nuvoton.

*Please note that all data and specifications are subject to change without notice.
All the trademarks of products and companies mentioned in this datasheet belong to their respective owners.*