

**Contact Information**

**540-Wire Wrap, Regular Point - Tail LG. = .560(14.22)  
 .100" (2.54mm) Contact Spacing x .200" (5.08mm) Row Spacing**

THIS IS A C.A.D. GENERATED DRAWING  
 DO NOT MAKE MANUAL REVISIONS TO MASTER.



ISSUE NUMBER

ORIGINAL ①

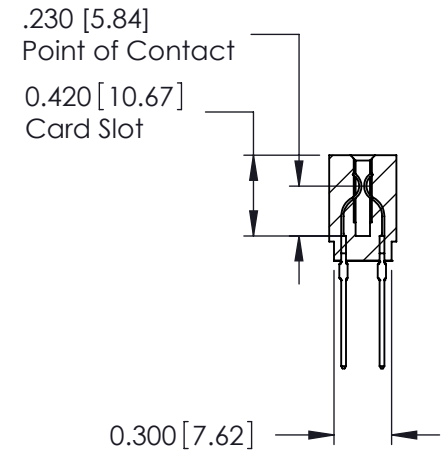
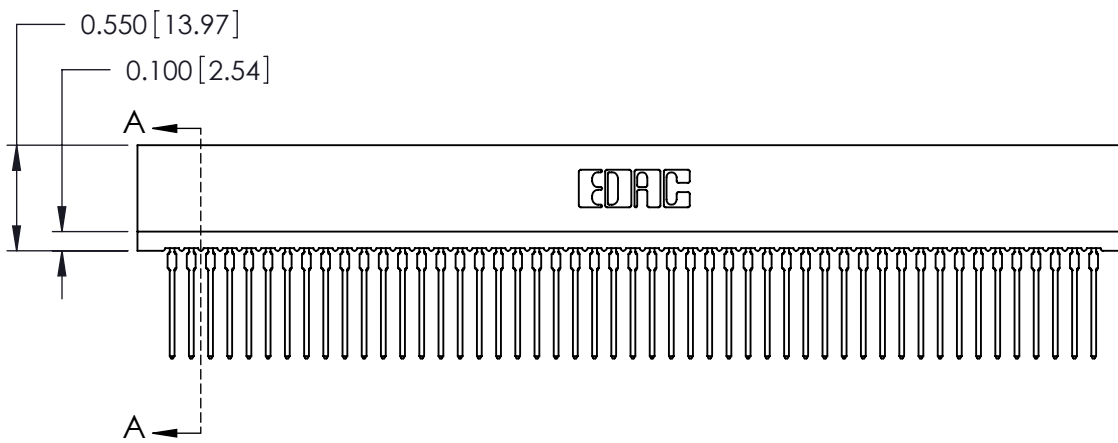
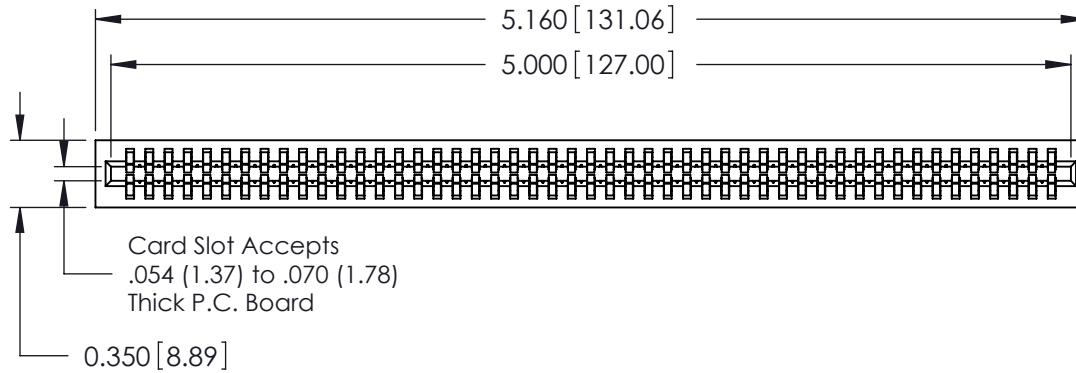

725 Series Ultra-Mate Card Edge Connector - Press Fit

Part Number: 725-098-540-201



YOUR CONNECTION TO QUALITY & SERVICE

EDAC INC  
 TORONTO, ONTARIO  
 CANADA

THESE DRAWINGS AND SPECIFICATIONS  
 ARE THE PROPERTY OF EDAC INC. AND  
 SHALL NOT BE REPRODUCED, OR COPIED  
 OR USED AS THE BASIS FOR THE  
 MANUFACTURE OR SALE OF APPARATUS  
 WITHOUT WRITTEN PERMISSION.

|                    |                |
|--------------------|----------------|
| ACAD REFERENCE NO. | 725-ENG MASTER |
| DRAWN:             | J.LEE          |
| CHECKED:           |                |
| SCALE:             |                |
| DRAWING NUMBER     | 725-ENG MASTER |
| DATE:              | AUG 31 1989    |
| DATE:              |                |
| SHEET              | 1 OF 1         |
| ISSUE              | 1              |

SECTION A-A