

Data sheet | Item number: 2201-1302

3-conductor through terminal block; with push-button; 1.5 mm²; with test port; suitable for Ex e II applications; side and center marking; for DIN-rail 35 x 15 and 35 x 7.5; Push-in CAGE CLAMP®; 1,50 mm²; orange

www.wago.com/2201-1302

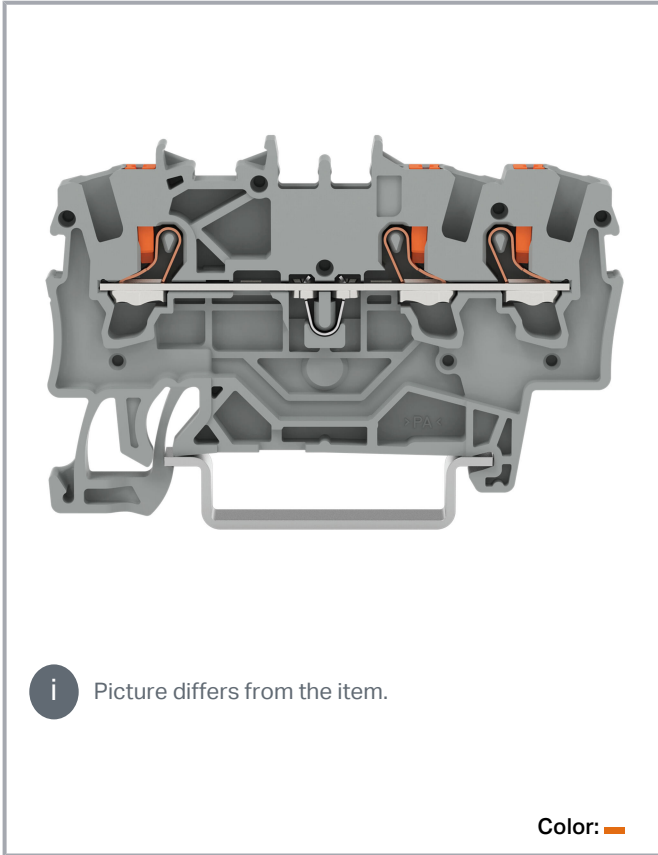

Data

Electrical data

Ratings per IEC/EN

Ratings per	IEC/EN 60947-7-1
Nominal voltage (III/3)	800 V
Rated impulse voltage (III/3)	8 kV
Rated current	18 A
Current at conductor cross-section (max.) mm ²	24 A
Legend (ratings)	(III / 3) ≙ Overvoltage category III / Pollution degree 3

Subject to changes. Please also observe the further product documentation!

WAGO GmbH & Co. KG
Hansastr. 27
32423 Minden
Phone: +49571 887-0 | Fax: +49571 887-169
Email: info.de@wago.com | Web: www.wago.com

Do you have any questions about our products?
We are always happy to take your call at +49 (571) 887-44222.



Ratings per UL 1059

Approvals per	UL 1059
Rated voltage UL (Use Group B)	600 V
Rated current UL (Use Group B)	15 A
Rated voltage UL (Use Group C)	600 V
Rated current UL (Use Group C)	15 A

Ratings per CSA

Approvals per	CSA 22.2 No 158
Rated voltage CSA (Use Group B)	600 V
Rated current CSA (Use Group B)	15 A
Rated voltage CSA (Use Group C)	600 V
Rated current CSA (Use Group C)	15 A

Ex information

Reference hazardous areas	See "Downloads – Documentation – Additional Information: Technical Section; Technical Explications"
Ratings per	ATEX: PTB 18 ATEX 1004 U / IECEx: PTB 18.0011U (Ex eb IIC Gb)
Rated voltage EN (Ex e II)	550 V
Rated current (Ex e II)	17.5 A

Power loss

Power loss, per pole (potential)	0.593 W
Rated current I_N for specified power loss	18 A
Resistance value for specified, current-dependent power loss	0.002 Ω

Connection data

Connection points	3
Total number of potentials	1
Number of levels	1
Number of jumper slots	2

Connection 1

Connection technology	Push-in CAGE CLAMP®
Actuation type	Push-button

Subject to changes. Please also observe the further product documentation!



Connectable conductor materials	Copper
Nominal cross-section	1.5 mm ²
Solid conductor	0.25 ... 2.5 mm ² / 22 ... 14 AWG
Solid conductor; push-in termination	0.75 ... 2.5 mm ² / 18 ... 14 AWG
Fine-stranded conductor	0.25 ... 2.5 mm ² / 22 ... 14 AWG
Fine-stranded conductor; with insulated ferrule	0.75 ... 1.5 mm ² / 18 ... 16 AWG
Fine-stranded conductor; with ferrule; push-in termination	0.75 ... 1.5 mm ² / 18 ... 16 AWG
Note (conductor cross-section)	Depending on the conductor characteristic, a conductor with a smaller cross-section can also be inserted via push-in termination.
Strip length	9 ... 11 mm / 0.35 ... 0.43 inches
Wiring direction	Front-entry wiring

Physical data

Width	4.2 mm / 0.165 inches
Height	59.2 mm / 2.33 inches
Depth from upper-edge of DIN-rail	32.9 mm / 1.295 inches

Mechanical Data

Mounting type	DIN-35 rail
Marking level	Center/side marking

Material Data

Note (material data)	Information on material specifications can be found here
Color	orange
Material group	I
Insulation material	Polyamide (PA66)
Flammability class per UL94	V0
Fire load	0.128 MJ
Weight	4.9 g

Environmental requirements

Processing temperature	-35 ... +85 °C
Continuous operating temperature	-60 ... +105 °C

Subject to changes. Please also observe the further product documentation!

WAGO GmbH & Co. KG
 Hansastr. 27
 32423 Minden
 Phone: +49571 887-0 | Fax: +49571 887-169
 Email: info.de@wago.com | Web: www.wago.com

Do you have any questions about our products?
 We are always happy to take your call at +49 (571) 887-44222.

Commercial data





ETIM 8.0	EC000897
ETIM 7.0	EC000897
PU (SPU)	100 pcs
Packaging type	box
Country of origin	DE
GTIN	4055143919036
Customs tariff number	85369010000

Environmental Product Compliance

RoHS Compliance Status	Compliant, No Exemption
------------------------	-------------------------

Approvals / Certificates

General approvals

Logo	Approval	Additional Approval Text	Certificate name
	CCA DEKRA Certification B.V.	EN 60947	NTR NL 7825
	CCC CNEX	GB/T 3836.3	2020312313000167 (Ex eb IIC Gb, Ex eb I Mb)
	cURus Underwriters Laboratories Inc.	UL 1059	E45172
	KEMA/KEUR DEKRA Certification B.V.	EN 60947	71-113099

Declarations of conformity and manufacturer's declarations

Logo	Approval	Additional Approval Text	Certificate name
	EU-Declaration of Conformity WAGO GmbH & Co. KG	-	-

Subject to changes. Please also observe the further product documentation!







UK-Declaration of Conformity
WAGO GmbH & Co. KG





-

-

Approvals for marine applications

Logo	Approval	Additional Approval Text	Certificate name
	ABS American Bureau of Shipping	-	19- HG1866350- PDA
	BV Bureau Veritas S.A.	IEC 60947	58186/A0 BV
	DNV GL Det Norske Veritas, Germanischer Lloyd	-	TAE00003JT
	LR Lloyds Register	-	19/20050

Approvals for hazardous areas

Logo	Approval	Additional Approval Text	Certificate name
	AEx UL International Germany GmbH c/o Physikalisch Technische Bundesanstalt	UL 60079	E185892 (AEx eb IIC resp. Ex eb IIC)
	ATEX Physikalisch Technische Bundesanstalt	IEC 60079-0	PTB 18 ATEX 1004 U (II 2 G Ex eb IIC Gb bzw. I M 2 Ex eb I Mb)
	CCC CNEX	GB/T 3836.3	2020312313000167 (Ex eb IIC Gb, Ex eb I Mb)
	IECEx Physikalisch Technische Bundesanstalt	IEC 60079-0	IECEx PTB 18.0011U (Ex eb IIC Gb and Ex eb I Mb)
	INMETRO	IEC 60079	TÜV 19.0083 U

Subject to changes. Please also observe the further product documentation!

WAGO GmbH & Co. KG
Hansastr. 27
32423 Minden
Phone: +49571 887-0 | Fax: +49571 887-169
Email: info.de@wago.com | Web: www.wago.com

Do you have any questions about our products?
We are always happy to take your call at +49 (571) 887-44222.





TÜV Rheinland do Brasil Ltda.

Required accessories

End plate

End plate

	Item no.: 209-191 Separator for Ex e/Ex i applications; 3 mm thick; 120 mm wide; orange	www.wago.com/209-191
	Item no.: 2002-1391 End and intermediate plate; 0.8 mm thick; gray	www.wago.com/2002-1391
	Item no.: 2002-1392 End and intermediate plate; 0.8 mm thick; orange	www.wago.com/2002-1392

Optional accessories



Push-in type wire jumper

Jumper

	Item no.: 2009-412 Push-in type wire jumper; insulated; 60 mm long; black	www.wago.com/2009-412
	Item no.: 2009-414 Push-in type wire jumper; 1.5 mm ² ; insulated; 110 mm long; black	www.wago.com/2009-414
	Item no.: 2009-416 Push-in type wire jumper; 1.5 mm ² ; insulated; 250 mm long; black	www.wago.com/2009-416
	Item no.: 2009-414/000-005 Push-in type wire jumper; 1.5 mm ² ; insulated; 110 mm long; black	www.wago.com/2009-414/000-005
	Item no.: 2009-414/000-006 Push-in type wire jumper; insulated; 110 mm long; black	www.wago.com/2009-414/000-006

Ferrule

Ferrule

	Item no.: 216-241 Ferrule; Sleeve for 0.5 mm ² / 20 AWG; insulated; electro-tin plated; electrolytic copper; gastight crimped; acc. to DIN 46228, Part 4/09.90; white	www.wago.com/216-241
	Item no.: 216-242 Ferrule; Sleeve for 0.75 mm ² / 18 AWG; insulated; electro-tin plated; electrolytic copper; gastight crimped; acc. to DIN 46228, Part 4/09.90; gray	www.wago.com/216-242
	Item no.: 216-243	

Subject to changes. Please also observe the further product documentation!

WAGO GmbH & Co. KG
 Hansastr. 27
 32423 Minden
 Phone: +49571 887-0 | Fax: +49571 887-169
 Email: info.de@wago.com | Web: www.wago.com

Do you have any questions about our products?
 We are always happy to take your call at +49 (571) 887-44222.

Ferrule; Sleeve for 1 mm² / AWG 18; insulated; electro-tin plated; electrolytic copper; gastight crimped; www.wago.com/216-243
acc. to DIN 46228, Part 4/09.90; red

**Item no.: 216-244**

Ferrule; Sleeve for 1.5 mm² / AWG 16; insulated; electro-tin plated; electrolytic copper; gastight crimped; acc. to DIN 46228, Part 4/09.90; black

www.wago.com/216-244

Mounting

Cover carrier

**Item no.: 709-169**

Cover carrier; Type 3; gray

www.wago.com/709-169

Cover

**Item no.: 709-156**

Cover; Type 3; suitable for cover carrier, type 3; 1 m long; transparent

www.wago.com/709-156

Jumpers

Jumper

**Item no.: 210-123**

Wire commoning chain; insulated; blue

www.wago.com/210-123

**Item no.: 2006-499**

Step-down jumper; from 2006/2004 to 2004/2002/2001 series; from 2206/2204 to 2204/2202/2201 series; insulated; light gray

www.wago.com/2006-499

**Item no.: 2001-402**

Jumper; 2-way; insulated; light gray

www.wago.com/2001-402

**Item no.: 2001-403**

Jumper; 3-way; insulated; light gray

www.wago.com/2001-403

**Item no.: 2001-405**

Jumper; 5-way; insulated; light gray

www.wago.com/2001-405

**Item no.: 2001-406/020-000**

Delta jumper; insulated; light gray

www.wago.com/2001-406/020-000

**Item no.: 2001-405/011-000**

Star point jumper; 3-way; insulated; light gray

www.wago.com/2001-405/011-000

**Item no.: 2001-407**

Jumper; 7-way; insulated; light gray

www.wago.com/2001-407

**Item no.: 2001-409**

Jumper; 9-way; insulated; light gray

www.wago.com/2001-409

**Item no.: 2001-406**

Jumper; 6-way; insulated; light gray

www.wago.com/2001-406

**Item no.: 2001-404**

Subject to changes. Please also observe the further product documentation!

WAGO GmbH & Co. KG

Hansastr. 27

32423 Minden

Phone: +49571 887-0 | Fax: +49571 887-169

Email: info.de@wago.com | Web: www.wago.com

Do you have any questions about our products?

We are always happy to take your call at +49 (571) 887-44222.

Jumper; 4-way; insulated; light gray

www.wago.com/2001-404



Item no.: 2001-410

Jumper; 10-way; insulated; light gray

www.wago.com/2001-410



Item no.: 2001-433

Jumper; from 1 to 3; insulated; light gray

www.wago.com/2001-433



Item no.: 2001-435

Jumper; from 1 to 5; insulated; light gray

www.wago.com/2001-435



Item no.: 2001-408

Jumper; 8-way; insulated; light gray

www.wago.com/2001-408



Item no.: 2001-437

Jumper; from 1 to 7; insulated; light gray

www.wago.com/2001-437



Item no.: 2001-436

Jumper; from 1 to 6; insulated; light gray

www.wago.com/2001-436



Item no.: 2001-440

Jumper; from 1 to 10; insulated; light gray

www.wago.com/2001-440



Item no.: 2001-438

Jumper; from 1 to 8; insulated; light gray

www.wago.com/2001-438



Item no.: 2001-434

Jumper; from 1 to 4; insulated; light gray

www.wago.com/2001-434



Item no.: 2001-439

Jumper; from 1 to 9; insulated; light gray

www.wago.com/2001-439



Item no.: 210-103

Wire commoning chain; insulated; black

www.wago.com/210-103

Insulation stop

Insulation stop



Item no.: 2001-171

Insulation stop; 0.25 - 0.5 mm²; 5 pieces/strip; light gray

www.wago.com/2001-171

Tool

Operating tool



Item no.: 210-648

Operating tool; Blade: 2.5 x 0.4 mm; with a partially insulated shaft; angled; short

www.wago.com/210-648



Item no.: 210-647

Operating tool; Blade: 2.5 x 0.4 mm; with a partially insulated shaft; multicoloured

www.wago.com/210-647

Subject to changes. Please also observe the further product documentation!

WAGO GmbH & Co. KG

Hansastr. 27

32423 Minden

Phone: +49571 887-0 | Fax: +49571 887-169

Email: info.de@wago.com | Web: www.wago.com

Do you have any questions about our products?















We are always happy to take your call at +49 (571) 887-44222.



Item no.: 210-719
Operating tool; Blade: 2.5 x 0.4 mm; with a partially insulated shaft

Testing and measuring







Testing accessories

	Item no.: 2009-174 Test plug adapter; for 4 mm Ø test plugs; for testing TOPJOB®S rail-mounted terminal blocks; gray	www.wago.com/2009-174
	Item no.: 2009-182 Testing tap; for max. 2.5 mm ² ; tool-free connection for individual test wires 0.08 - 2.5 mm; gray	www.wago.com/2009-182
	Item no.: 2001-511 Modular TOPJOB®S connector; modular; for jumper contact slot; 1-pole; 1,50 mm ² ; gray	www.wago.com/2001-511
	Item no.: 2001-554 Modular TOPJOB®S connector; modular; for jumper contact slot; 4-pole; 1,50 mm ² ; gray	www.wago.com/2001-554
	Item no.: 2001-549 Spacer module; modular; e.g., for bridging commoned terminal blocks; gray	www.wago.com/2001-549
	Item no.: 2001-556 Modular TOPJOB®S connector; modular; for jumper contact slot; 6-pole; 1,50 mm ² ; gray	www.wago.com/2001-556
	Item no.: 2001-557 Modular TOPJOB®S connector; modular; for jumper contact slot; 7-pole; 1,50 mm ² ; gray	www.wago.com/2001-557
	Item no.: 2001-553 Modular TOPJOB®S connector; modular; for jumper contact slot; 3-pole; 1,50 mm ² ; gray	www.wago.com/2001-553
	Item no.: 2001-552 Modular TOPJOB®S connector; modular; for jumper contact slot; 2-pole; 1,50 mm ² ; gray	www.wago.com/2001-552
	Item no.: 2001-558 Modular TOPJOB®S connector; modular; for jumper contact slot; 8-pole; 1,50 mm ² ; gray	www.wago.com/2001-558
	Item no.: 2001-560 Modular TOPJOB®S connector; modular; for jumper contact slot; 10-pole; 1,50 mm ² ; gray	www.wago.com/2001-560
	Item no.: 2001-555 Modular TOPJOB®S connector; modular; for jumper contact slot; 5-pole; 1,50 mm ² ; gray	www.wago.com/2001-555
	Item no.: 2001-559 Modular TOPJOB®S connector; modular; for jumper contact slot; 9-pole; 1,50 mm ² ; gray	www.wago.com/2001-559
	Item no.: 210-136 Test plug; 2 mm Ø; with 500 mm cable; red	www.wago.com/210-136

Subject to changes. Please also observe the further product documentation!

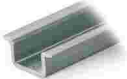
Carrier rail

Mounting accessories

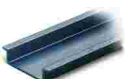



	Item no.: 210-197 Steel carrier rail; 35 x 15 mm; 1.5 mm thick; 2 m long; slotted; similar to EN 60715; silver-colored	www.wago.com/210-197
	Item no.: 210-198 Copper carrier rail; 35 x 15 mm; 2.3 mm thick; 2 m long; unslotted; according to EN 60715; copper-colored	www.wago.com/210-198
	Item no.: 210-113 Steel carrier rail; 35 x 7.5 mm; 1 mm thick; 2 m long; unslotted; according to EN 60715; silver-colored	www.wago.com/210-113
	Item no.: 210-118 Steel carrier rail; 35 x 15 mm; 2.3 mm thick; 2 m long; unslotted; according to EN 60715; silver-colored	www.wago.com/210-118
	Item no.: 210-112 Steel carrier rail; 35 x 7.5 mm; 1 mm thick; 2 m long; slotted; according to EN 60715; "Hole width 25 mm; silver-colored	www.wago.com/210-112
	Item no.: 210-114 Steel carrier rail; 35 x 15 mm; 1.5 mm thick; 2 m long; unslotted; similar to EN 60715; silver-colored	www.wago.com/210-114
	Item no.: 210-115 Steel carrier rail; 35 x 7.5 mm; 1 mm thick; 2 m long; slotted; according to EN 60715; "Hole width 18 mm; silver-colored	www.wago.com/210-115
	Item no.: 210-196 Aluminum carrier rail; 35 x 8.2 mm; 1.6 mm thick; 2 m long; unslotted; similar to EN 60715; silver-colored	www.wago.com/210-196

Marking accessories













Marking strip

	Item no.: 2009-110 Marking strips; for Smart Printer; on reel; not stretchable; plain; snap-on type; white	www.wago.com/2009-110
--	--	--

Marker

	Item no.: 2009-114/000-002 WMB-Inline; for Smart Printer; 2000 pieces on roll; stretchable 4 - 4.2 mm; plain; snap-on type; yellow	www.wago.com/2009-114/000-002
	Item no.: 2009-114/000-005 WMB-Inline; for Smart Printer; 2000 pieces on roll; stretchable 4 - 4.2 mm; plain; snap-on type; red	www.wago.com/2009-114/000-005
	Item no.: 2009-114/000-007 WMB-Inline; for Smart Printer; 2000 pieces on roll; stretchable 4 - 4.2 mm; plain; snap-on type; gray	www.wago.com/2009-114/000-007
	Item no.: 2009-114/000-023 WMB-Inline; for Smart Printer; 2000 pieces on roll; stretchable 4 - 4.2 mm; plain; snap-on type; green	www.wago.com/2009-114/000-023

Subject to changes. Please also observe the further product documentation!

	Item no.: 2009-114/000-006 WMB-Inline; for Smart Printer; 2000 pieces on roll; stretchable 4 - 4.2 mm; plain; snap-on type; blue	www.wago.com/2009-114/000-006
	Item no.: 2009-114/000-024 WMB-Inline; for Smart Printer; 2000 pieces on roll; stretchable 4 - 4.2 mm; plain; snap-on type; violet	www.wago.com/2009-114/000-024
	Item no.: 2009-114/000-012 WMB-Inline; for Smart Printer; 2000 pieces on roll; stretchable 4 - 4.2 mm; plain; snap-on type; orange	www.wago.com/2009-114/000-012
	Item no.: 2009-114 WMB-Inline; for Smart Printer; 2000 pieces on roll; stretchable 4 - 4.2 mm; plain; snap-on type; white	www.wago.com/2009-114
	Item no.: 793-4501/000-002 WMB marking card; as card; stretchable 4 - 4.2 mm; plain; snap-on type; yellow	www.wago.com/793-4501/000-002
	Item no.: 793-4501/000-006 WMB marking card; as card; stretchable 4 - 4.2 mm; plain; snap-on type; blue	www.wago.com/793-4501/000-006
	Item no.: 793-4501 WMB marking card; as card; stretchable 4 - 4.2 mm; plain; snap-on type; white	www.wago.com/793-4501
	Item no.: 793-4501/000-023 WMB marking card; as card; stretchable 4 - 4.2 mm; plain; snap-on type; green	www.wago.com/793-4501/000-023
	Item no.: 793-4501/000-024 WMB marking card; as card; stretchable 4 - 4.2 mm; plain; snap-on type; violet	www.wago.com/793-4501/000-024
	Item no.: 793-4501/000-005 WMB marking card; as card; stretchable 4 - 4.2 mm; plain; snap-on type; red	www.wago.com/793-4501/000-005
	Item no.: 793-4501/000-007 WMB marking card; as card; stretchable 4 - 4.2 mm; plain; snap-on type; gray	www.wago.com/793-4501/000-007
	Item no.: 793-4501/000-012 WMB marking card; as card; stretchable 4 - 4.2 mm; plain; snap-on type; orange	www.wago.com/793-4501/000-012

Subject to changes. Please also observe the further product documentation!



Item no.: 793-4501/000-017

WMB marking card; as card; stretchable 4 - 4.2 mm; plain; snap-on type; light green

www.wago.com/793-4501/000-017

Downloads

Documentation

Additional Information

Technical Section	pdf	Download
Technical explanations	2.2 MB	

CAD/CAE-Data

CAD data

2D/3D Models 2201-1302	URL	Download
------------------------	-----	----------

CAE data

ZUKEN Portal 2201-1302	URL	Download
------------------------	-----	----------

Environmental Product Compliance

Compliance Search

Environmental Product Compliance 2201-1302	URL	Download
--	-----	----------

3-conductor through terminal block; with push-button; 1.5 mm²; with test port; suitable for Ex e II applications; side and center marking; for DIN-rail 35 x 15 and 35 x 7.5; Push-in CAGE CLAMP®; 1,50 mm²; orange

Installation Notes

Conductor termination

Subject to changes. Please also observe the further product documentation!

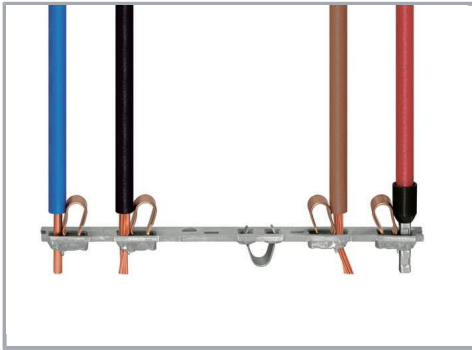

All conductor types at a glance



Push-in termination of solid and ferruled conductors



Insert fine-stranded conductors via operating tool.



Removing all conductors via operating tool.

Commoning



Insert a push-in type jumper bar and push down until it hits the backstop.

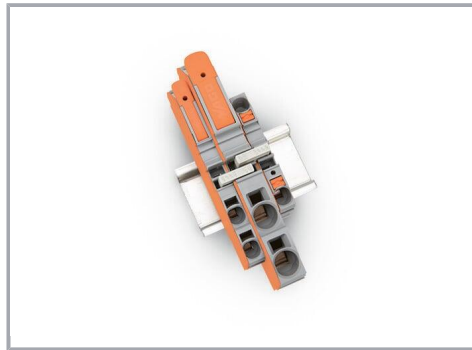

Commoning with step-down jumpers.

Subject to changes. Please also observe the further product documentation!



Step-down jumper (2006-499) commons 6 /4 mm² (10/12 AWG) terminal blocks (2206 /2204 Series) with 4/2.5/1.5 mm² (AWG 12/14 /16) terminal blocks (2204/2202/2201 Series).

Testing

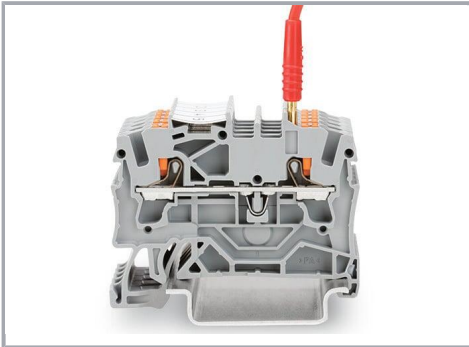

Testing with a 2 mm Ø test plug (max. 42 V).

Marking

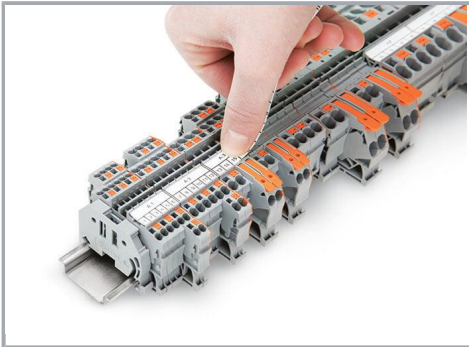

Snapping a marking strip into a marker slot.

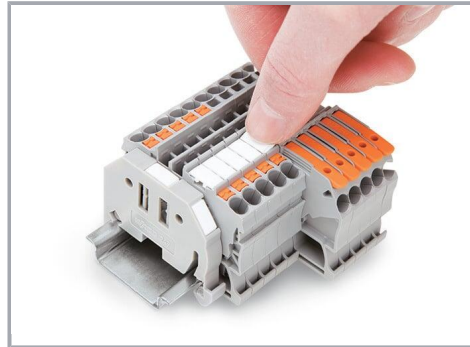

Snapping a marking strip into the marker slot.

Product family

Subject to changes. Please also observe the further product documentation!

WAGO GmbH & Co. KG
Hansastr. 27
32423 Minden
Phone: +49571 887-0 | Fax: +49571 887-169
Email: info.de@wago.com | Web: www.wago.com

Do you have any questions about our products?
We are always happy to take your call at +49 (571) 887-44222.



TOPJOB® S

TOPJOB® S: In various industrial applications and modern building installations, WAGO's wide and versatile range of rail-mount terminal blocks provides more than just reliable electrical connections.

[Show all products from the family](#)

Subject to changes. Please also observe the further product documentation!

WAGO GmbH & Co. KG
Hansastr. 27
32423 Minden
Phone: +49571 887-0 | Fax: +49571 887-169
Email: info.de@wago.com | Web: www.wago.com

Do you have any questions about our products?
We are always happy to take your call at +49 (571) 887-44222.