

DO NOT SCALE FROM THIS PRINT

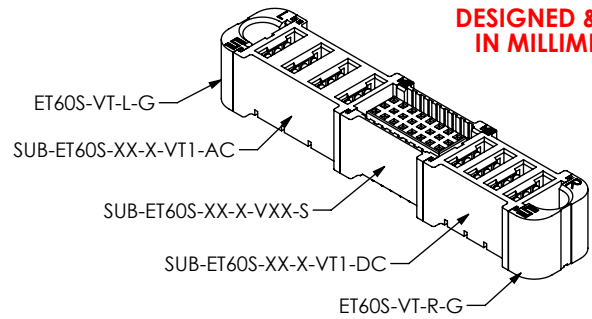

DESIGNED & DIMENSIONED IN MILLIMETERS [INCHES]

ET60S-XXX-X-XX-XXX-X-VX-X

POWER OPTION (RIGHT)

- AXX: AC POWER
- DXX: DC POWER
- *-SXX: SPLIT POWER
- 000: NO POWER
- (SEE NOTE 5)

ROWS

- 0: NO SIGNAL
- 3: 3 ROWS
- 5: 5 ROWS (-VP TAIL ONLY)

SIGNAL POS PER ROW

- XX: SEE NOTE 6
- 00: NO SIGNAL

GUIDE POST (MUST CHOOSE ONE)

- S: SIDE
- *-T: TOP

TAIL

- VP: PRESS FIT
- V1: FOR .062" PCB (NOT AVAILABLE FOR 5 ROWS)
- *-V2: FOR .093" PCB

PLATING SPECIFICATION

- L: 10 μ" SELECTIVE GOLD IN CONTACT AREA, MATTE TIN ON TAIL
- S: 30 μ" SELECTIVE GOLD IN CONTACT AREA, MATTE TIN ON TAIL

POWER OPTION (LEFT)

- AXX: AC POWER
- DXX: DC POWER
- *-SXX: SPLIT POWER
- 000: NO POWER
- (SEE NOTE 5)

(* = NOT TOOLED)

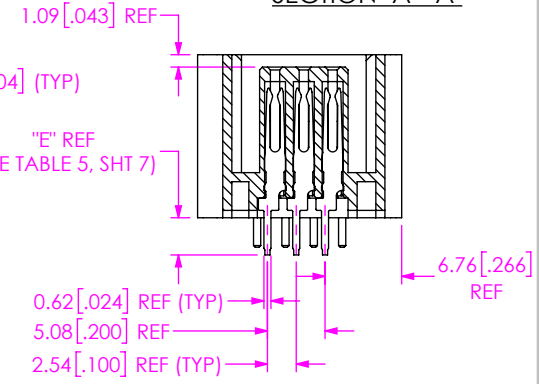
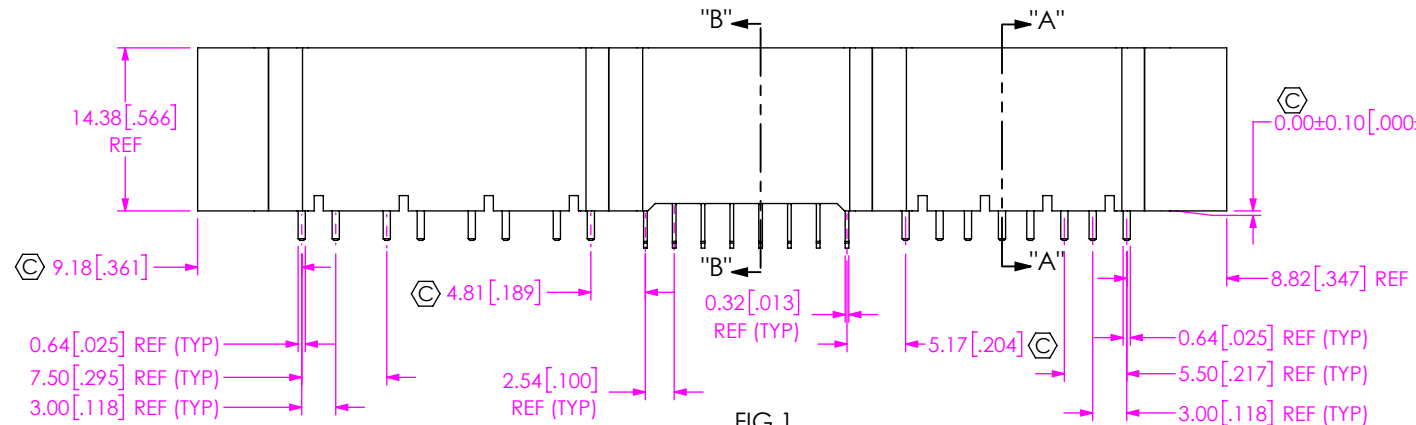
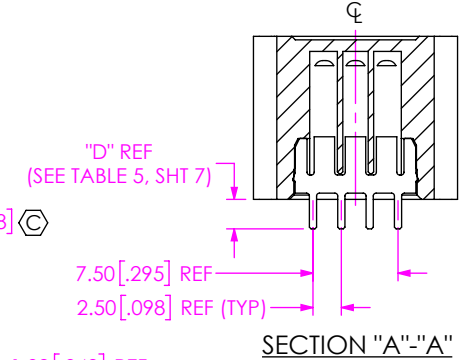
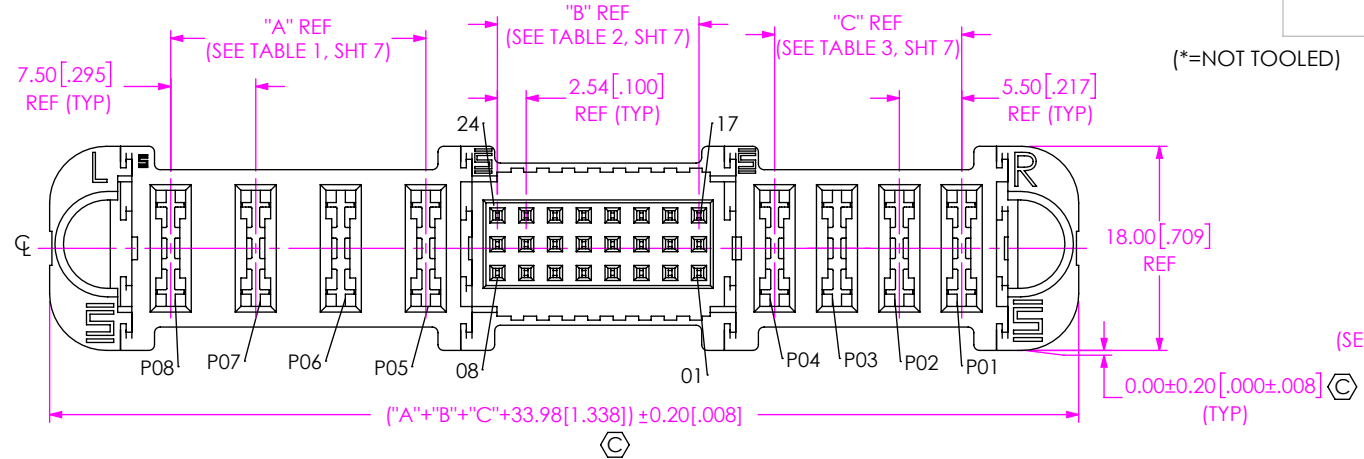

FIG 1
ET60S-D04-3-08-A04-X-V1-S SHOWN

- NOTES:
1. Ⓢ REPRESENTS A CRITICAL DIMENSION.
 2. MINIMUM PUSHOUT FORCE: 1.5 LBS FOR SIGNAL PINS;
3.0 LBS FOR POWER PINS.
 3. SEE PRODUCT SPECIFICATION FOR CONNECTOR PRESS FIT INSTRUCTIONS AND REQUIRED FIXTURES.
 4. ASSEMBLIES TO BE PACKAGED IN TRAYS.
 5. -AC POWER: *01, -02, -03, -04, -05, -06;
-DC POWER: *01, -02, -03, -04, -05, -06, -07, -08, -09, -10 (* = NOT TOOLED)
 6. -3 ROWS: *02, *04, *06, -08, *10, *12.
-5 ROWS: -01, -02, -03, -04, -05, -06, -07, -08. (* = NOT TOOLED)

UNLESS OTHERWISE SPECIFIED, DIMENSIONS ARE IN MILLIMETERS.
TOLERANCES ARE:
DECIMALS ANGLES
X.X: ±0.3 [.01]
X.XX: ±0.13 [.005]
X.XXX: ±0.051 [.0020]

PROPRIETARY NOTE
THIS DOCUMENT CONTAINS CONFIDENTIAL AND PROPRIETARY INFORMATION AND ALL DESIGN, MANUFACTURING, REPRODUCTION, USE, PATENT RIGHTS AND SALES RIGHTS ARE EXPRESSLY RESERVED BY SAMTEC, INC. THIS DOCUMENT SHALL NOT BE DISCLOSED, IN WHOLE OR PART, TO ANY UNAUTHORIZED PERSON OR ENTITY NOR REPRODUCED, TRANSFERRED OR INCORPORATED IN ANY OTHER PROJECT IN ANY MANNER WITHOUT THE EXPRESS WRITTEN CONSENT OF SAMTEC, INC.

MATERIAL: DO NOT SCALE DRAWING SHEET SCALE: 1.5:1
INSULATOR: LCP, COLOR: BLACK
SIGNAL CONTACT: COPPER ALLOY
POWER CONTACT: COPPER ALLOY



520 PARK EAST BLVD, NEW ALBANY, IN 47150
PHONE: 812-944-6733 FAX: 812-948-5047
e-Mail: info@SAMTEC.com code 53322

DESCRIPTION:
ET60 VERTICAL POWER/SIGNAL SOCKET
DWG. NO.
ET60S-XXX-X-XX-XXX-X-VX-X
BY: PETER D 07/27/2016 SHEET 1 OF 7

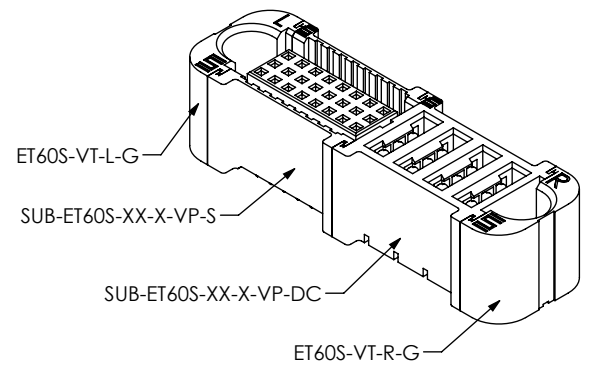
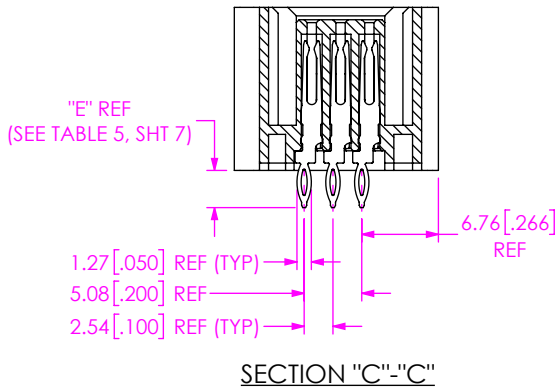
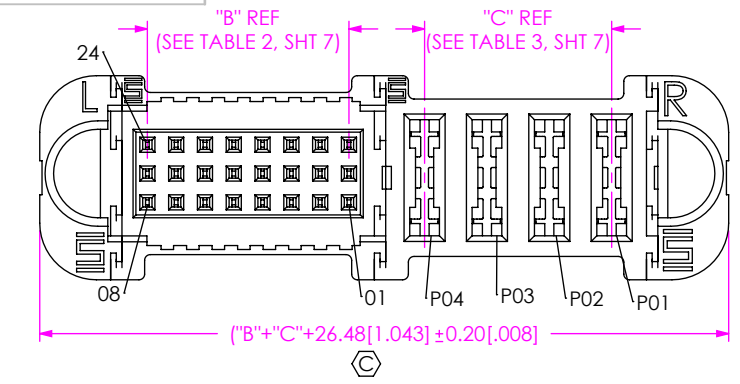

FIG 2
ET60S-D04-3-08-000-X-VP-S SHOWN
(DIFFERENT AS SHOWN, OTHERWISE SAME AS FIG 1)

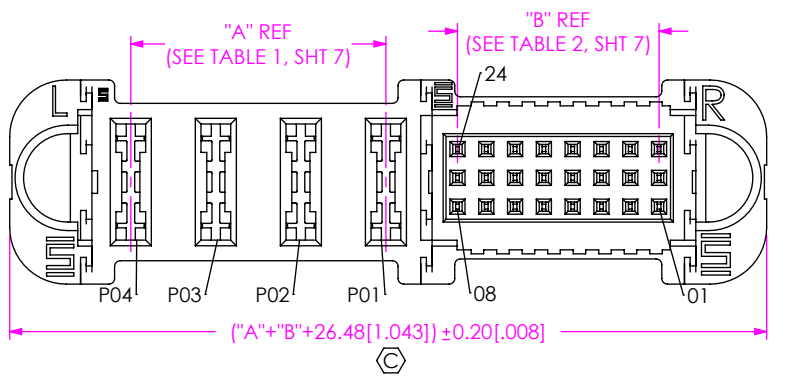
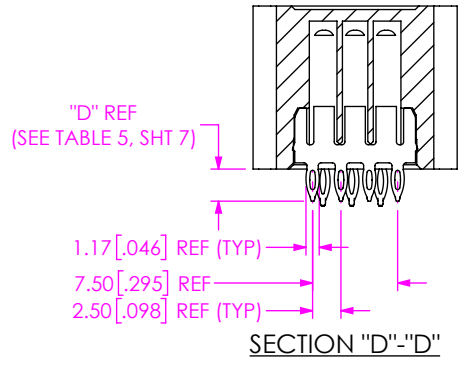
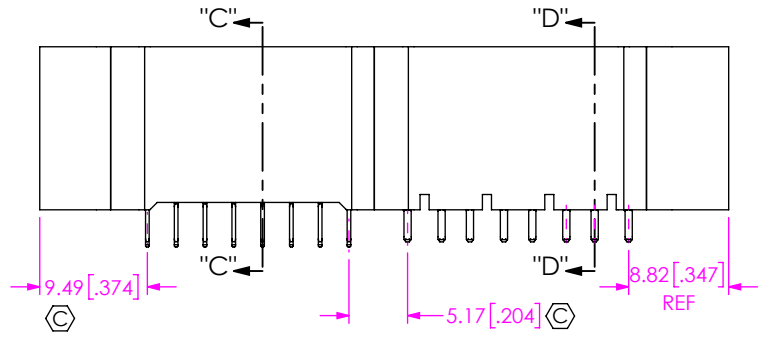
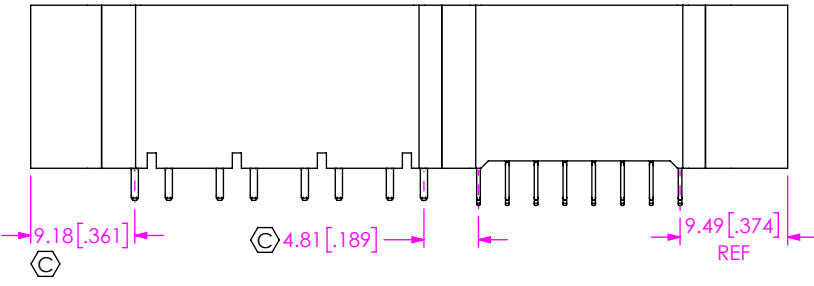
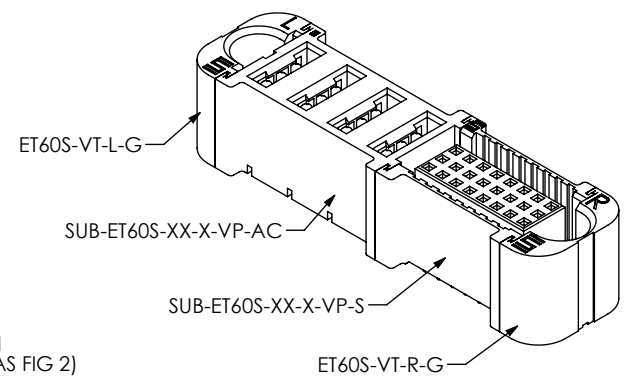

FIG 3
ET60S-000-3-08-A04-X-VP-S SHOWN
(DIFFERENT AS SHOWN, OTHERWISE SAME AS FIG 2)



PROPRIETARY NOTE
THIS DOCUMENT CONTAINS CONFIDENTIAL AND PROPRIETARY INFORMATION AND ALL DESIGN, MANUFACTURING, REPRODUCTION, USE, PATENT RIGHTS AND SALES RIGHTS ARE EXPRESSLY RESERVED BY SAMTEC, INC. THIS DOCUMENT SHALL NOT BE DISCLOSED, IN WHOLE OR PART, TO ANY UNAUTHORIZED PERSON OR ENTITY NOR REPRODUCED, TRANSFERRED OR INCORPORATED IN ANY OTHER PROJECT IN ANY MANNER WITHOUT THE EXPRESS WRITTEN CONSENT OF SAMTEC, INC.

DO NOT SCALE DRAWING

SHEET SCALE: 1.5:1

520 PARK EAST BLVD, NEW ALBANY, IN 47150
PHONE: 812-944-6733 FAX: 812-948-5047
e-Mail info@SAMTEC.com code 55322

DESCRIPTION:
ET60 VERTICAL POWER/SIGNAL SOCKET

DWG. NO.
ET60S-XXX-X-XX-XXX-X-VX-X

BY: PETER D 07/27/2016 SHEET 2 OF 7

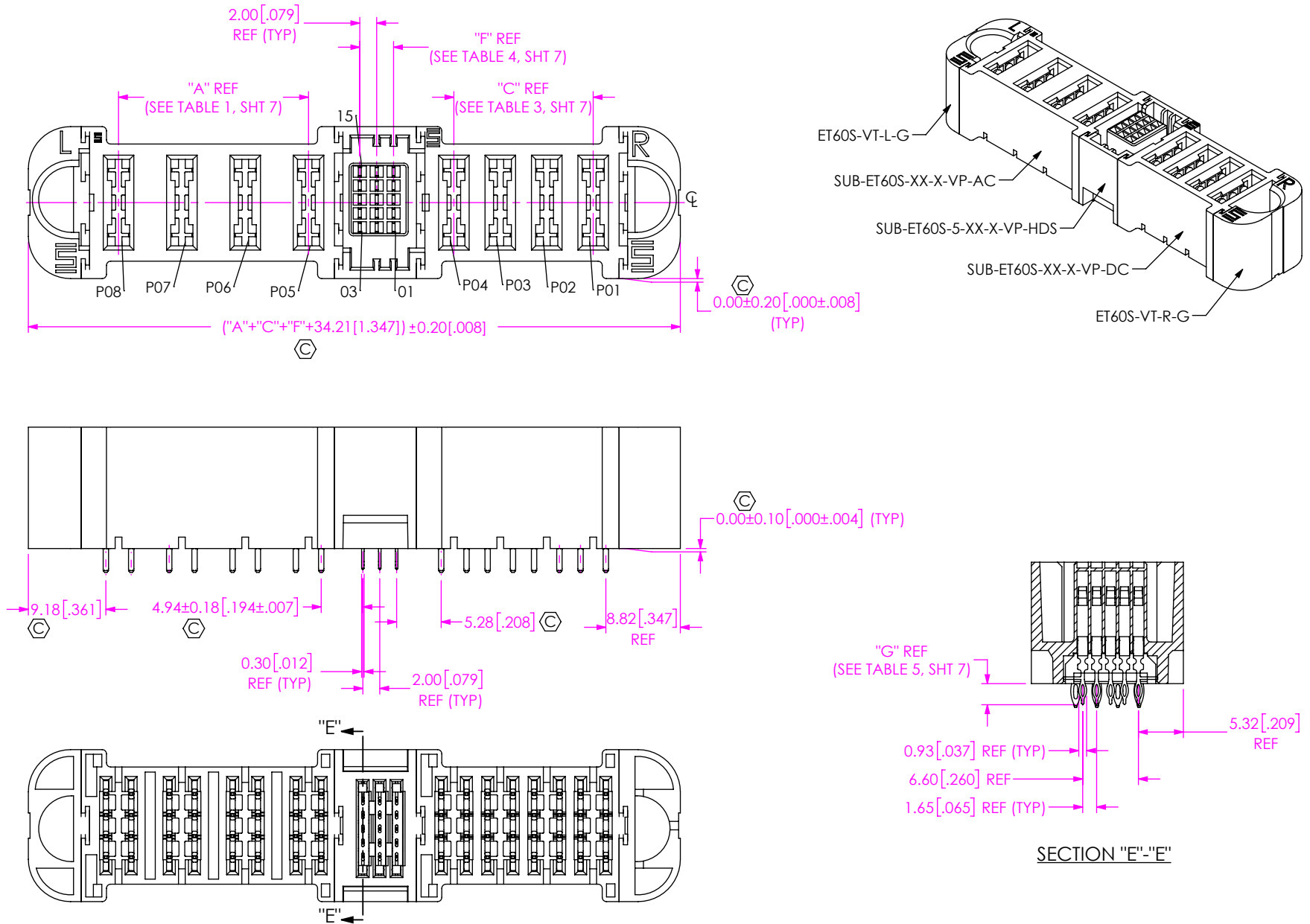

FIG 4
 ET60S-D04-5-03-A04-X-VP-S SHOWN
 (DIFFERENT AS SHOWN, OTHERWISE SAME AS FIG 1 & 2)

PROPRIETARY NOTE
 THIS DOCUMENT CONTAINS CONFIDENTIAL AND PROPRIETARY INFORMATION AND ALL DESIGN, MANUFACTURING, REPRODUCTION, USE, PATENT RIGHTS AND SALES RIGHTS ARE EXPRESSLY RESERVED BY SAMTEC, INC. THIS DOCUMENT SHALL NOT BE DISCLOSED, IN WHOLE OR PART, TO ANY UNAUTHORIZED PERSON OR ENTITY NOR REPRODUCED, TRANSFERRED OR INCORPORATED IN ANY OTHER PROJECT IN ANY MANNER WITHOUT THE EXPRESS WRITTEN CONSENT OF SAMTEC, INC.

DO NOT SCALE DRAWING
 SHEET SCALE: 1.5:1



520 PARK EAST BLVD., NEW ALBANY, IN 47150
 PHONE: 812-944-6733 FAX: 812-948-5047
 e-Mail: info@SAMTEC.com code 55322

DESCRIPTION:	ET60 VERTICAL POWER/SIGNAL SOCKET
DWG. NO.	ET60S-XXX-X-XX-XXX-X-VX-X
BY:	PETER D 07/27/2016 SHEET 3 OF 7

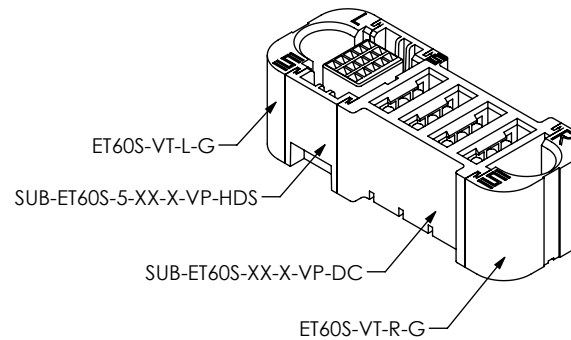
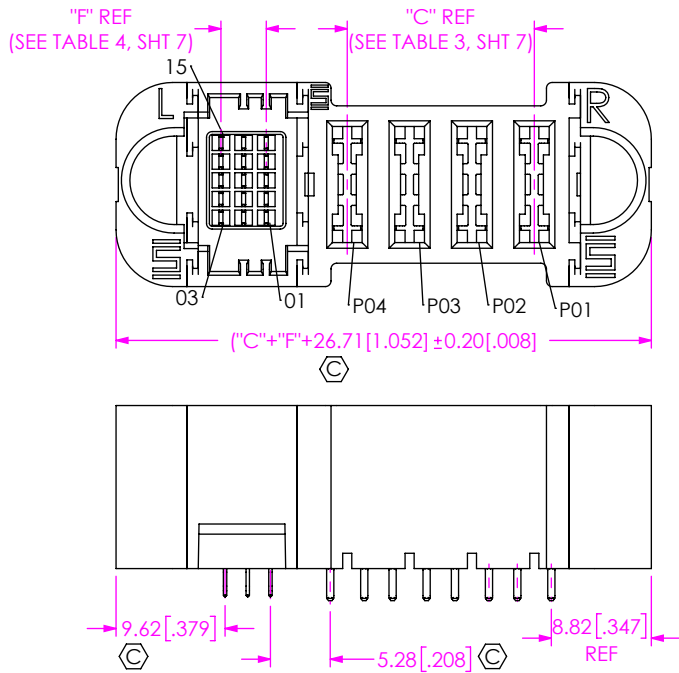

FIG 5
 ET60S-D04-5-03-000-X-VP-S SHOWN
 (DIFFERENT AS SHOWN, OTHERWISE SAME AS FIG 4)

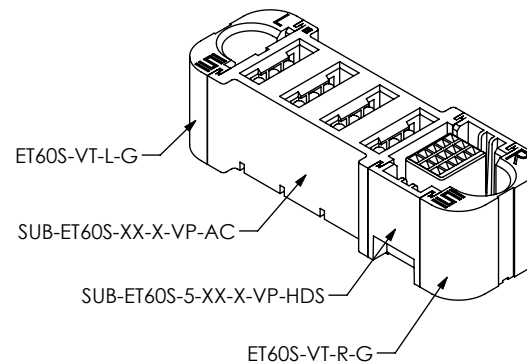
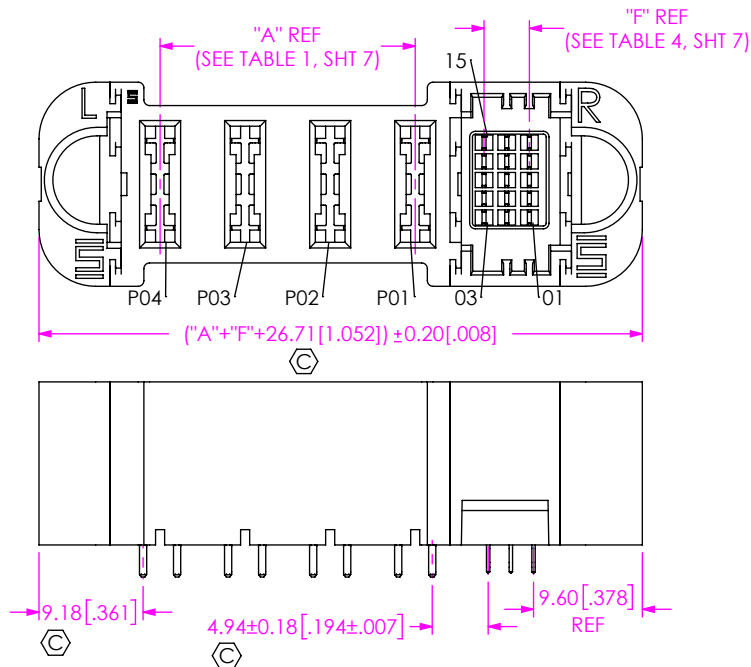

FIG 6
 ET60S-000-5-03-A04-X-VP-S SHOWN
 (DIFFERENT AS SHOWN, OTHERWISE SAME AS FIG 4)

F:\DWG\MISC\MKTG\ET60S-XXX-X-XX-XXX-X-VX-X-MKT.SLDDRW

PROPRIETARY NOTE
 THIS DOCUMENT CONTAINS CONFIDENTIAL AND PROPRIETARY INFORMATION AND ALL DESIGN, MANUFACTURING, REPRODUCTION, USE, PATENT RIGHTS AND SALES RIGHTS ARE EXPRESSLY RESERVED BY SAMTEC, INC. THIS DOCUMENT SHALL NOT BE DISCLOSED, IN WHOLE OR PART, TO ANY UNAUTHORIZED PERSON OR ENTITY NOR REPRODUCED, TRANSFERRED OR INCORPORATED IN ANY OTHER PROJECT IN ANY MANNER WITHOUT THE EXPRESS WRITTEN CONSENT OF SAMTEC, INC.

DO NOT SCALE DRAWING

SHEET SCALE: 1.5:1



520 PARK EAST BLVD, NEW ALBANY, IN 47150
 PHONE: 812-944-6733 FAX: 812-948-5047
 e-Mail info@SAMTEC.com code 55322

DESCRIPTION:
 ET60 VERTICAL POWER/SIGNAL SOCKET

DWG. NO.
 ET60S-XXX-X-XX-XXX-X-VX-X

BY: PETER D 07/27/2016 SHEET 4 OF 7

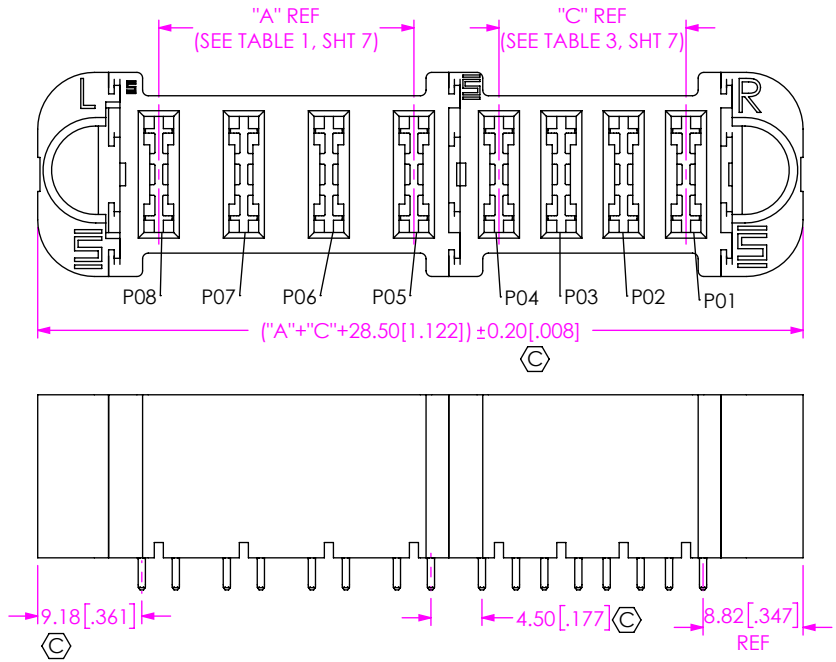

FIG 7
 ET60S-D04-0-00-A04-X-VP-S SHOWN
 (DIFFERENT AS SHOWN, OTHERWISE SAME AS FIG 4)

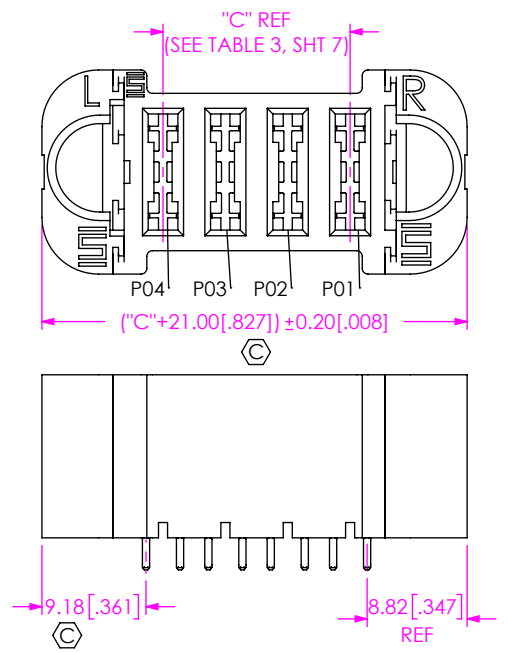
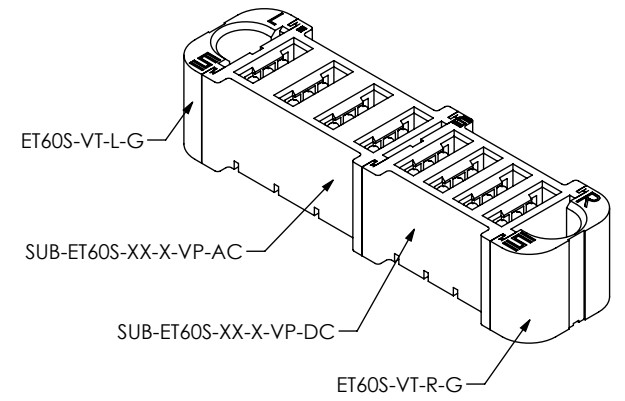
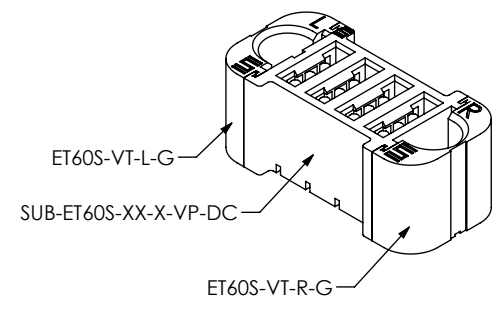

FIG 8
 ET60S-D04-0-00-000-X-VP-S SHOWN
 (DIFFERENT AS SHOWN, OTHERWISE SAME AS FIG 4)



PROPRIETARY NOTE
 THIS DOCUMENT CONTAINS CONFIDENTIAL AND PROPRIETARY INFORMATION AND ALL DESIGN, MANUFACTURING, REPRODUCTION, USE, PATENT RIGHTS AND SALES RIGHTS ARE EXPRESSLY RESERVED BY SAMTEC, INC. THIS DOCUMENT SHALL NOT BE DISCLOSED, IN WHOLE OR PART, TO ANY UNAUTHORIZED PERSON OR ENTITY NOR REPRODUCED, TRANSFERRED OR INCORPORATED IN ANY OTHER PROJECT IN ANY MANNER WITHOUT THE EXPRESS WRITTEN CONSENT OF SAMTEC, INC.

DO NOT SCALE DRAWING
 SHEET SCALE: 1.5:1



DESCRIPTION:
 ET60 VERTICAL POWER/SIGNAL SOCKET

DWG. NO.
 ET60S-XXX-X-XX-XXX-X-VX-X

BY: PETER D 07/27/2016 SHEET 5 OF 7

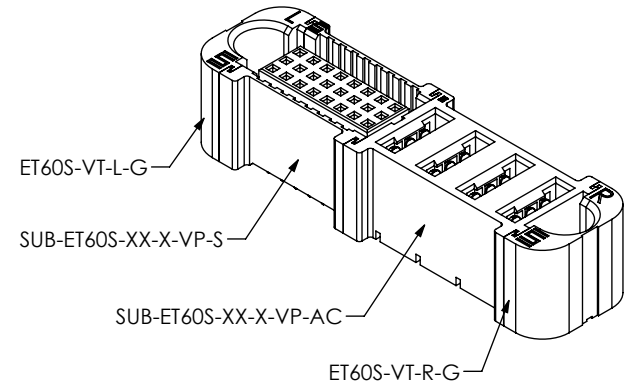
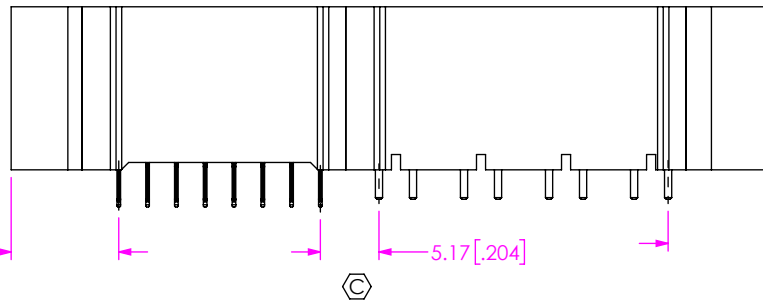
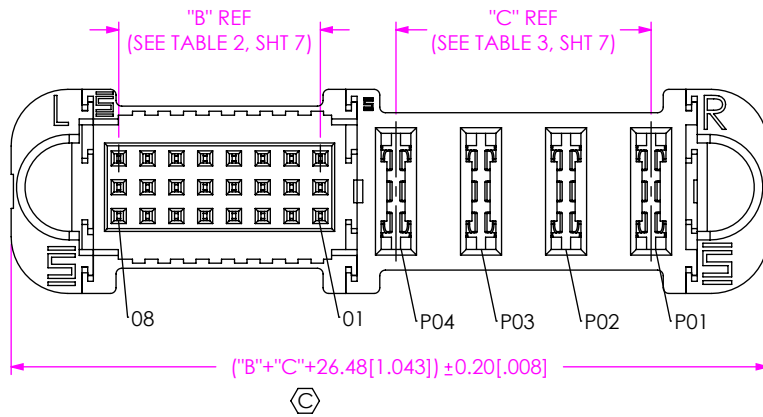

FIG 9
ET60S-A04-3-08-000-X-VP-S SHOWN
(DIFFERENT AS SHOWN, OTHERWISE SAME AS FIG 2)

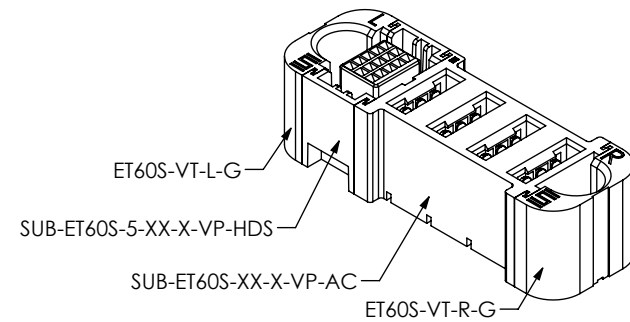
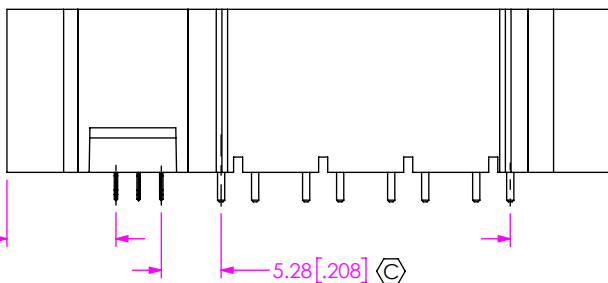
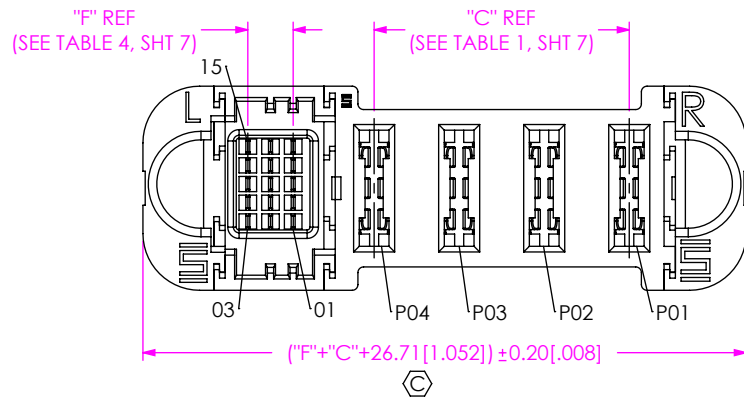

FIG 10
ET60S-A04-5-03-000-X-VP-S SHOWN
(DIFFERENT AS SHOWN, OTHERWISE SAME AS FIG 4)

PROPRIETARY NOTE

THIS DOCUMENT CONTAINS CONFIDENTIAL AND PROPRIETARY INFORMATION AND ALL DESIGN, MANUFACTURING, REPRODUCTION, USE, PATENT RIGHTS AND SALES RIGHTS ARE EXPRESSLY RESERVED BY SAMTEC, INC. THIS DOCUMENT SHALL NOT BE DISCLOSED, IN WHOLE OR PART, TO ANY UNAUTHORIZED PERSON OR ENTITY NOR REPRODUCED, TRANSFERRED OR INCORPORATED IN ANY OTHER PROJECT IN ANY MANNER WITHOUT THE EXPRESS WRITTEN CONSENT OF SAMTEC, INC.



520 PARK EAST BLVD, NEW ALBANY, IN 47150
PHONE: 812-944-6733 FAX: 812-948-5047
e-Mail: info@SAMTEC.com code 55322

SHEET SCALE: 2:1

DESCRIPTION:
ET60 VERTICAL POWER/SIGNAL SOCKET

DWG. NO.
ET60S-XXX-X-XX-XXX-X-VX-X

BY: PETER D 07/27/2016 SHEET 6 OF 7

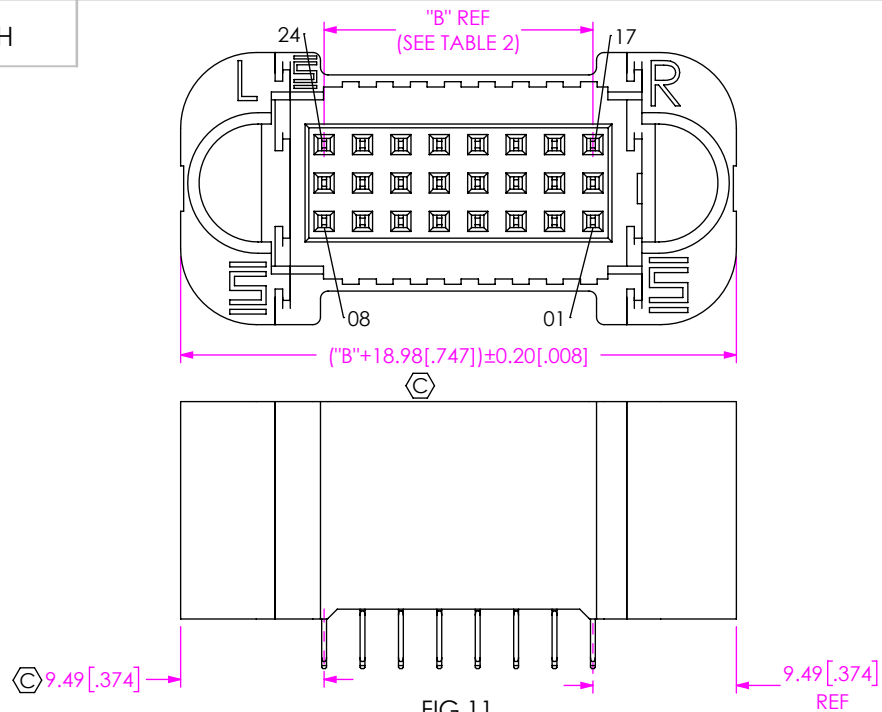

FIG 11
ET60S-000-3-08-000-X-VP-S SHOWN
(DIFFERENT AS SHOWN, OTHERWISE SAME AS FIG 1)

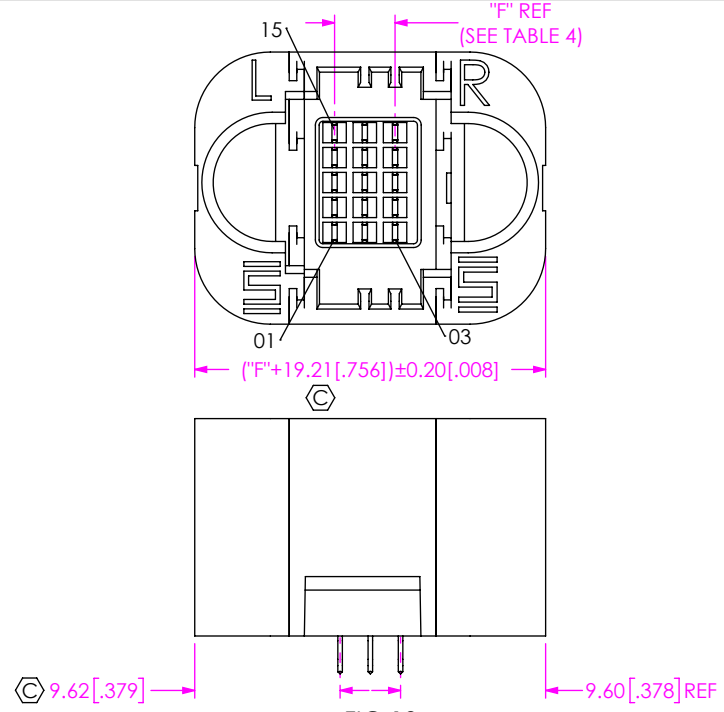

FIG 12
ET60S-000-5-03-000-X-VP-S SHOWN
(DIFFERENT AS SHOWN, OTHERWISE SAME AS FIG 4)

POWER POS (LEFT)	"A"	
	AC POWER	DC POWER
*-01	N/A	N/A
-02	7.50 [.295]	5.50 [.217]
-03	15.00 [.591]	11.00 [.433]
-04	22.50 [.886]	16.50 [.650]
-05	30.00 [1.181]	22.00 [.866]
-06	37.50 [1.476]	27.50 [1.083]
-07	/	33.00 [1.299]
-08	/	38.50 [1.516]
-09	/	44.00 [1.732]
-10	/	49.50 [1.949]

(* = NOT TOOLED)

SIGNAL POS PER ROW (3 ROWS)	"B"
*-02	2.54 [.100]
*-04	7.62 [.300]
*-06	12.70 [.500]
-08	17.78 [.700]
*-10	22.86 [.900]
*-12	27.94 [1.100]

(* = NOT TOOLED)

POWER POS (RIGHT)	"C"	
	AC POWER	DC POWER
*-01	N/A	N/A
-02	7.50 [.295]	5.50 [.217]
-03	15.00 [.591]	11.00 [.433]
-04	22.50 [.886]	16.50 [.650]
-05	30.00 [1.181]	22.00 [.866]
-06	37.50 [1.476]	27.50 [1.083]
-07	/	33.00 [1.299]
-08	/	38.50 [1.516]
-09	/	44.00 [1.732]
-10	/	49.50 [1.949]

(* = NOT TOOLED)

SIGNAL POS PER ROW (5 ROWS)	"F"
-01	N/A
-02	2.00 [.079]
-03	4.00 [.157]
-04	6.00 [.236]
-05	8.00 [.315]
-06	10.00 [.394]
-07	12.00 [.472]
-08	14.00 [.551]

SIGNAL POS	3 ROWS		5 ROWS	
	"D"	"E"	"D"	"G"
-VP	2.83 [.111]	3.28 [.129]	2.83 [.111]	2.50 [.098]
-V1	2.60 [.102]	3.28 [.129]	N/A	N/A
*-V2	3.38 [.133]	4.06 [.160]	N/A	N/A

(* = NOT TOOLED)

F:\DWG\MISC\MKTG\ET60S-XXX-X-XX-XXX-X-VX-X-MKT.SLDDRW

PROPRIETARY NOTE
THIS DOCUMENT CONTAINS CONFIDENTIAL AND PROPRIETARY INFORMATION AND ALL DESIGN, MANUFACTURING, REPRODUCTION, USE, PATENT RIGHTS AND SALES RIGHTS ARE EXPRESSLY RESERVED BY SAMTEC, INC. THIS DOCUMENT SHALL NOT BE DISCLOSED, IN WHOLE OR PART, TO ANY UNAUTHORIZED PERSON OR ENTITY NOR REPRODUCED, TRANSFERRED OR INCORPORATED IN ANY OTHER PROJECT IN ANY MANNER WITHOUT THE EXPRESS WRITTEN CONSENT OF SAMTEC, INC.

DO NOT SCALE DRAWING

SHEET SCALE: 2:1



520 PARK EAST BLVD, NEW ALBANY, IN 47150
PHONE: 812-944-6733 FAX: 812-948-5047
e-Mail info@SAMTEC.com code 55322

DESCRIPTION:
ET60 VERTICAL POWER/SIGNAL SOCKET

DWG. NO.
ET60S-XXX-X-XX-XXX-X-VX-X

BY: PETER D 07/27/2016 SHEET 7 OF 7