

Data sheet | Item number: 2002-2221/1000-434

Component terminal block; double-deck; LED (red); 24 VDC; for DIN-rail 35 x 15 and 35 x 7.5; 2.5 mm<sup>2</sup>; Push-in CAGE CLAMP®; 2,50 mm<sup>2</sup>; gray

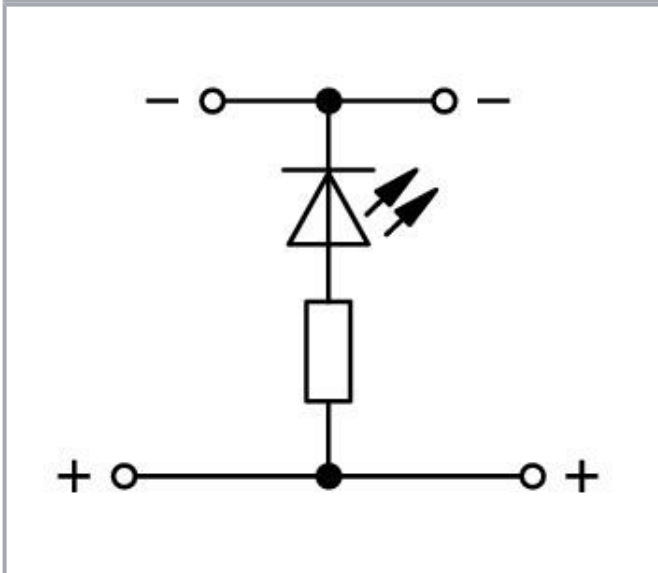

[www.wago.com/2002-2221/1000-434](http://www.wago.com/2002-2221/1000-434)

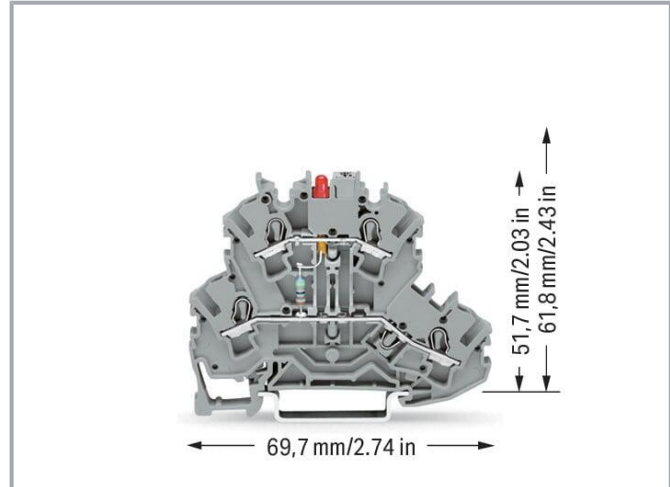
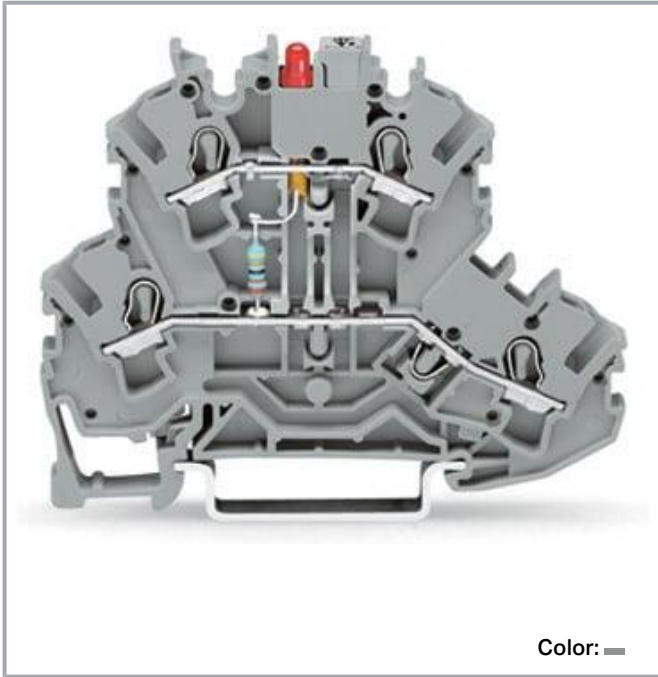

## Data

### Electrical data

Subject to changes. Please also observe the further product documentation!

WAGO GmbH & Co. KG  
Hansastr. 27  
32423 Minden  
Phone: +49571 887-0 | Fax: +49571 887-169  
Email: [info.de@wago.com](mailto:info.de@wago.com) | Web: [www.wago.com](http://www.wago.com)

Do you have any questions about our products?  
We are always happy to take your call at +49 (571) 887-44222.



## Ratings per IEC/EN

|               |                  |
|---------------|------------------|
| Ratings per   | IEC/EN 60947-7-1 |
| Rated current | 0.025 A          |

## General

|                 |      |
|-----------------|------|
| Voltage type 1  | DC   |
| Nominal voltage | 24 V |

## Connection data

|                            |   |
|----------------------------|---|
| Connection points          | 4 |
| Total number of potentials | 2 |
| Number of levels           | 2 |

## Connection 1

|  |   |
|--|---|
| Connection technology                                      | Push-in CAGE CLAMP®   |
| Actuation type   | Operating tool  |
| Connectable conductor materials                            | Copper  |
| Nominal cross-section                                      | 2.5 mm <sup>2</sup>   |
| Solid conductor  | 0.25 ... 4 mm <sup>2</sup> / 22 ... 12 AWG  |
| Solid conductor; push-in termination                       | 0.75 ... 4 mm <sup>2</sup> / 18 ... 12 AWG  |
| Fine-stranded conductor                                    | 0.25 ... 4 mm <sup>2</sup> / 22 ... 12 AWG  |
| Fine-stranded conductor; with insulated ferrule            | 0.25 ... 2.5 mm <sup>2</sup> / 22 ... 14 AWG  |
| Fine-stranded conductor; with ferrule; push-in termination | 1 ... 2.5 mm <sup>2</sup> / 18 ... 14 AWG   |
| Note (conductor cross-section)                             | Depending on the conductor characteristic, a conductor with a smaller cross-section can also be inserted via push-in termination. |
| Strip length   | 10 ... 12 mm / 0.39 ... 0.47 inches   |
| Wiring direction   | Front-entry wiring  |

## Physical data

|                                   |                        |
|-----------------------------------|------------------------|
| Width                             | 5.2 mm / 0.205 inches  |
| Height                            | 69.7 mm / 2.744 inches |
| Depth from upper-edge of DIN-rail | 51.7 mm / 2.035 inches |

## Mechanical Data

|               |             |
|---------------|-------------|
| Mounting type | DIN-35 rail |
|---------------|-------------|

Subject to changes. Please also observe the further product documentation!

WAGO GmbH & Co. KG

Hansastr. 27

32423 Minden

Phone: +49571 887-0 | Fax: +49571 887-169

Email: [info.de@wago.com](mailto:info.de@wago.com) | Web: [www.wago.com](http://www.wago.com)

Do you have any questions about our products?

We are always happy to take your call at +49 (571) 887-44222.



Marking level

Center/side marking

**Material Data**

Note (material data)

Information on material specifications can be found here

|                             |                  |
|-----------------------------|------------------|
| Color                       | gray             |
| Material group              | I                |
| Insulation material         | Polyamide (PA66) |
| Flammability class per UL94 | V0               |
| Fire load                   | 0.212 MJ         |
| Weight                      | 11 g             |

**Environmental requirements**

|                                  |                 |
|----------------------------------|-----------------|
| Processing temperature           | -35 ... +85 °C  |
| Continuous operating temperature | -60 ... +105 °C |

**Commercial data**

|                       |               |
|-----------------------|---------------|
| Product Group         | 22 (TOPJOB S) |
| eCl@ss 10.0           | 27-14-11-27   |
| eCl@ss 9.0            | 27-14-11-27   |
| ETIM 8.0              | EC000903      |
| ETIM 7.0              | EC000903      |
| PU (SPU)              | 50 pcs        |
| Packaging type        | box           |
| Country of origin     | DE            |
| GTIN                  | 4045454375645 |
| Customs tariff number | 85369010000   |

**Environmental Product Compliance**

|                        |                         |
|------------------------|-------------------------|
| RoHS Compliance Status | Compliant, No Exemption |
|------------------------|-------------------------|

**Required accessories****End plate**

|           |
|-----------|
| End plate |
|-----------|

Subject to changes. Please also observe the further product documentation!



**Item no.: 2002-2291**  
End and intermediate plate; 0.8 mm thick; gray

[www.wago.com/2002-2291](http://www.wago.com/2002-2291)











**Item no.: 2002-2292**  
End and intermediate plate; 0.8 mm thick; orange

[www.wago.com/2002-2292](http://www.wago.com/2002-2292)

## Optional accessories

### Ferrule

| Ferrule   |  |  |
|---|--|--|
|    | <b>Item no.: 216-241</b><br>Ferrule; Sleeve for 0.5 mm <sup>2</sup> / 20 AWG; insulated; electro-tin plated; electrolytic copper; gastight crimped; acc. to DIN 46228, Part 4/09.90; white | <a href="http://www.wago.com/216-241">www.wago.com/216-241</a> |
|    | <b>Item no.: 216-242</b><br>Ferrule; Sleeve for 0.75 mm <sup>2</sup> / 18 AWG; insulated; electro-tin plated; electrolytic copper; gastight crimped; acc. to DIN 46228, Part 4/09.90; gray | <a href="http://www.wago.com/216-242">www.wago.com/216-242</a> |
|    | <b>Item no.: 216-243</b><br>Ferrule; Sleeve for 1 mm <sup>2</sup> / AWG 18; insulated; electro-tin plated; electrolytic copper; gastight crimped; acc. to DIN 46228, Part 4/09.90; red     | <a href="http://www.wago.com/216-243">www.wago.com/216-243</a> |
|    | <b>Item no.: 216-244</b><br>Ferrule; Sleeve for 1.5 mm <sup>2</sup> / AWG 16; insulated; electro-tin plated; electrolytic copper; gastight crimped; acc. to DIN 46228, Part 4/09.90; black | <a href="http://www.wago.com/216-244">www.wago.com/216-244</a> |
|  | <b>Item no.: 216-263</b><br>Ferrule; Sleeve for 1 mm <sup>2</sup> / AWG 18; insulated; electro-tin plated; electrolytic copper; gastight crimped; acc. to DIN 46228, Part 4/09.90; red     | <a href="http://www.wago.com/216-263">www.wago.com/216-263</a> |
|  | <b>Item no.: 216-246</b><br>Ferrule; Sleeve for 2.5 mm <sup>2</sup> / AWG 14; insulated; electro-tin plated; electrolytic copper; gastight crimped; acc. to DIN 46228, Part 4/09.90; blue  | <a href="http://www.wago.com/216-246">www.wago.com/216-246</a> |
|  | <b>Item no.: 216-266</b><br>Ferrule; Sleeve for 2.5 mm <sup>2</sup> / AWG 14; insulated; electro-tin plated; electrolytic copper; gastight crimped; acc. to DIN 46228, Part 4/09.90; blue  | <a href="http://www.wago.com/216-266">www.wago.com/216-266</a> |
|  | <b>Item no.: 216-264</b><br>Ferrule; Sleeve for 1.5 mm <sup>2</sup> / AWG 16; insulated; electro-tin plated; electrolytic copper; gastight crimped; acc. to DIN 46228, Part 4/09.90; black | <a href="http://www.wago.com/216-264">www.wago.com/216-264</a> |
|  | <b>Item no.: 216-262</b><br>Ferrule; Sleeve for 0.75 mm <sup>2</sup> / 18 AWG; insulated; electro-tin plated; electrolytic copper; gastight crimped; acc. to DIN 46228, Part 4/09.90; gray | <a href="http://www.wago.com/216-262">www.wago.com/216-262</a> |

### Mounting

#### Cover carrier



**Item no.: 709-169**  
Cover carrier; Type 3; gray

[www.wago.com/709-169](http://www.wago.com/709-169)

#### Cover

Subject to changes. Please also observe the further product documentation!



Item no.: 709-156

Cover; Type 3; suitable for cover carrier, type 3; 1 m long; transparent

[www.wago.com/709-156](http://www.wago.com/709-156)

---

### Protective warning marker

Cover



Item no.: 2002-115

Protective warning marker; for 5 terminal blocks; with high-voltage symbol, black; yellow

[www.wago.com/2002-115](http://www.wago.com/2002-115)

---

### Testing and measuring

Testing accessories



Item no.: 2009-174

Test plug adapter; for 4 mm Ø test plugs; for testing TOPJOB®S rail-mounted terminal blocks; gray

[www.wago.com/2009-174](http://www.wago.com/2009-174)



Item no.: 2009-182

Testing tap; for max. 2.5 mm<sup>2</sup>; tool-free connection for individual test wires 0.08 - 2.5 mm; gray

[www.wago.com/2009-182](http://www.wago.com/2009-182)



Item no.: 2002-611

TOPJOB®S L-type test plug module; modular; 1-pole; 2,50 mm<sup>2</sup>; gray

[www.wago.com/2002-611](http://www.wago.com/2002-611)



Item no.: 2002-649

TOPJOB®S L-type spacer module; modular; e.g., for bridging commoned terminal blocks; gray

[www.wago.com/2002-649](http://www.wago.com/2002-649)

---

### Insulation stop

Insulation stop



Item no.: 2002-171

Insulation stop; 0.25 - 0.5 mm<sup>2</sup>; 5 pieces/strip; light gray

[www.wago.com/2002-171](http://www.wago.com/2002-171)



Item no.: 2002-172

Insulation stop; 0.75 - 1 mm<sup>2</sup>; 5 pieces/strip; dark gray

[www.wago.com/2002-172](http://www.wago.com/2002-172)

---

### Marking accessories

Marking strip



Item no.: 2009-110

Marking strips; for Smart Printer; on reel; not stretchable; plain; snap-on type; white

[www.wago.com/2009-110](http://www.wago.com/2009-110)

Marker carrier



Item no.: 2009-198

Adaptor; gray

[www.wago.com/2009-198](http://www.wago.com/2009-198)



Item no.: 2002-121

Adaptor; gray

[www.wago.com/2002-121](http://www.wago.com/2002-121)



Item no.: 2002-161

Subject to changes. Please also observe the further product documentation!

---

WAGO GmbH & Co. KG

Hansastr. 27

32423 Minden

Phone: +49571 887-0 | Fax: +49571 887-169

Email: [info.de@wago.com](mailto:info.de@wago.com) | Web: [www.wago.com](http://www.wago.com)













Do you have any questions about our products?

We are always happy to take your call at +49 (571) 887-44222.













Adaptor; gray

[www.wago.com/2002-161](http://www.wago.com/2002-161)

## Marker

|   |   |  |
|---|---|--|
|    | <b>Item no.: 2009-115/000-002</b><br>WMB-Inline; for Smart Printer; 1500 pieces on roll; stretchable 5 - 5.2 mm; plain; snap-on type; yellow      | <a href="http://www.wago.com/2009-115/000-002">www.wago.com/2009-115/000-002</a> |
|    | <b>Item no.: 2009-115/000-007</b><br>WMB-Inline; for Smart Printer; 1500 pieces on roll; stretchable 5 - 5.2 mm; plain; snap-on type; gray        | <a href="http://www.wago.com/2009-115/000-007">www.wago.com/2009-115/000-007</a> |
|    | <b>Item no.: 2009-115/000-017</b><br>WMB-Inline; for Smart Printer; 1500 pieces on roll; stretchable 5 - 5.2 mm; plain; snap-on type; light green | <a href="http://www.wago.com/2009-115/000-017">www.wago.com/2009-115/000-017</a> |
|    | <b>Item no.: 2009-115/000-023</b><br>WMB-Inline; for Smart Printer; 1500 pieces on roll; stretchable 5 - 5.2 mm; plain; snap-on type; green       | <a href="http://www.wago.com/2009-115/000-023">www.wago.com/2009-115/000-023</a> |
|    | <b>Item no.: 2009-115/000-024</b><br>WMB-Inline; for Smart Printer; 1500 pieces on roll; stretchable 5 - 5.2 mm; plain; snap-on type; violet      | <a href="http://www.wago.com/2009-115/000-024">www.wago.com/2009-115/000-024</a> |
|    | <b>Item no.: 2009-145/000-006</b><br>Mini-WSB Inline; for Smart Printer; 1700 pieces on roll; stretchable 5 - 5.2 mm; plain; snap-on type; blue   | <a href="http://www.wago.com/2009-145/000-006">www.wago.com/2009-145/000-006</a> |
|  | <b>Item no.: 2009-145</b><br>Mini-WSB Inline; for Smart Printer; 1700 pieces on roll; stretchable 5 - 5.2 mm; plain; snap-on type; white          | <a href="http://www.wago.com/2009-145">www.wago.com/2009-145</a>                 |
|  | <b>Item no.: 2009-145/000-002</b><br>Mini-WSB Inline; for Smart Printer; 1700 pieces on roll; stretchable 5 - 5.2 mm; plain; snap-on type; yellow | <a href="http://www.wago.com/2009-145/000-002">www.wago.com/2009-145/000-002</a> |
|  | <b>Item no.: 2009-145/000-007</b><br>Mini-WSB Inline; for Smart Printer; 1700 pieces on roll; stretchable 5 - 5.2 mm; plain; snap-on type; gray   | <a href="http://www.wago.com/2009-145/000-007">www.wago.com/2009-145/000-007</a> |
|  | <b>Item no.: 2009-145/000-005</b><br>Mini-WSB Inline; for Smart Printer; 1700 pieces on roll; stretchable 5 - 5.2 mm; plain; snap-on type; red    | <a href="http://www.wago.com/2009-145/000-005">www.wago.com/2009-145/000-005</a> |
|  | <b>Item no.: 2009-145/000-012</b><br>Mini-WSB Inline; for Smart Printer; 1700 pieces on roll; stretchable 5 - 5.2 mm; plain; snap-on type; orange | <a href="http://www.wago.com/2009-145/000-012">www.wago.com/2009-145/000-012</a> |
|  | <b>Item no.: 2009-145/000-023</b><br>Mini-WSB Inline; for Smart Printer; 1700 pieces on roll; stretchable 5 - 5.2 mm; plain; snap-on type; green  | <a href="http://www.wago.com/2009-145/000-023">www.wago.com/2009-145/000-023</a> |

Subject to changes. Please also observe the further product documentation!

|  |   |  |
|--|---|--|
|    | <b>Item no.: 2009-145/000-024</b><br>Mini-WSB Inline; for Smart Printer; 1700 pieces on roll; stretchable 5 - 5.2 mm; plain; snap-on type; violet       | <a href="http://www.wago.com/2009-145/000-024">www.wago.com/2009-145/000-024</a> |
|    | <b>Item no.: 2009-115</b><br>WMB-Inline; for Smart Printer; 1500 pieces on roll; stretchable 5 - 5.2 mm; plain; snap-on type; white                     | <a href="http://www.wago.com/2009-115">www.wago.com/2009-115</a>                 |
|    | <b>Item no.: 248-501/000-006</b><br>Mini-WSB marking card; as card; not stretchable; plain; snap-on type; blue  | <a href="http://www.wago.com/248-501/000-006">www.wago.com/248-501/000-006</a>   |
|    | <b>Item no.: 248-501/000-007</b><br>Mini-WSB marking card; as card; not stretchable; plain; snap-on type; gray  | <a href="http://www.wago.com/248-501/000-007">www.wago.com/248-501/000-007</a>   |
|    | <b>Item no.: 248-501/000-002</b><br>Mini-WSB marking card; as card; not stretchable; plain; snap-on type; yellow  | <a href="http://www.wago.com/248-501/000-002">www.wago.com/248-501/000-002</a>   |
|    | <b>Item no.: 248-501/000-012</b><br>Mini-WSB marking card; as card; not stretchable; plain; snap-on type; orange  | <a href="http://www.wago.com/248-501/000-012">www.wago.com/248-501/000-012</a>   |
|   | <b>Item no.: 248-501</b><br>Mini-WSB marking card; as card; not stretchable; plain; snap-on type; white   | <a href="http://www.wago.com/248-501">www.wago.com/248-501</a>                   |
|  | <b>Item no.: 248-501/000-017</b><br>Mini-WSB marking card; as card; not stretchable; plain; snap-on type; light green                                   | <a href="http://www.wago.com/248-501/000-017">www.wago.com/248-501/000-017</a>   |
|  | <b>Item no.: 248-501/000-005</b><br>Mini-WSB marking card; as card; not stretchable; plain; snap-on type; red   | <a href="http://www.wago.com/248-501/000-005">www.wago.com/248-501/000-005</a>   |
|  | <b>Item no.: 248-501/000-024</b><br>Mini-WSB marking card; as card; not stretchable; plain; snap-on type; violet  | <a href="http://www.wago.com/248-501/000-024">www.wago.com/248-501/000-024</a>   |
|  | <b>Item no.: 248-501/000-023</b><br>Mini-WSB marking card; as card; not stretchable; plain; snap-on type; green   | <a href="http://www.wago.com/248-501/000-023">www.wago.com/248-501/000-023</a>   |
|  | <b>Item no.: 793-5501/000-007</b><br>WMB marking card; as card; for terminal block width 5 - 17.5 mm; stretchable 5 - 5.2 mm; plain; snap-on type; gray | <a href="http://www.wago.com/793-5501/000-007">www.wago.com/793-5501/000-007</a> |

Subject to changes. Please also observe the further product documentation!



**Item no.:** 793-5501/000-012

WMB marking card; as card; for terminal block width 5 - 17.5 mm; stretchable 5 - 5.2 mm; plain; snap-on type; orange

[www.wago.com/793-5501](http://www.wago.com/793-5501)

/000-012



**Item no.:** 793-5501/000-014

WMB marking card; as card; for terminal block width 5 - 17.5 mm; stretchable 5 - 5.2 mm; plain; snap-on type; brown

[www.wago.com/793-5501](http://www.wago.com/793-5501)

/000-014



**Item no.:** 793-5501/000-017

WMB marking card; as card; for terminal block width 5 - 17.5 mm; stretchable 5 - 5.2 mm; plain; snap-on type; light green

[www.wago.com/793-5501](http://www.wago.com/793-5501)

/000-017

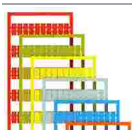

**Item no.:** 793-5501/000-023

WMB marking card; as card; for terminal block width 5 - 17.5 mm; stretchable 5 - 5.2 mm; plain; snap-on type; green

[www.wago.com/793-5501](http://www.wago.com/793-5501)

/000-023



**Item no.:** 793-5501/000-024

WMB marking card; as card; for terminal block width 5 - 17.5 mm; stretchable 5 - 5.2 mm; plain; snap-on type; violet

[www.wago.com/793-5501](http://www.wago.com/793-5501)

/000-024

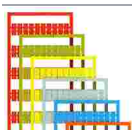

**Item no.:** 793-5501/000-005

WMB marking card; as card; for terminal block width 5 - 17.5 mm; stretchable 5 - 5.2 mm; plain; snap-on type; red

[www.wago.com/793-5501](http://www.wago.com/793-5501)

/000-005

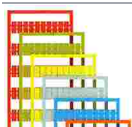

**Item no.:** 793-5501/000-002

WMB marking card; as card; for terminal block width 5 - 17.5 mm; stretchable 5 - 5.2 mm; plain; snap-on type; yellow

[www.wago.com/793-5501](http://www.wago.com/793-5501)

/000-002

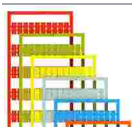

**Item no.:** 793-5501/000-006

WMB marking card; as card; for terminal block width 5 - 17.5 mm; stretchable 5 - 5.2 mm; plain; snap-on type; blue

[www.wago.com/793-5501](http://www.wago.com/793-5501)

/000-006



**Item no.:** 793-5501

WMB marking card; as card; for terminal block width 5 - 17.5 mm; stretchable 5 - 5.2 mm; plain; snap-on type; white

[www.wago.com/793-5501](http://www.wago.com/793-5501)



**Item no.:** 2009-115/000-012

WMB-Inline; for Smart Printer; 1500 pieces on roll; stretchable 5 - 5.2 mm; plain; snap-on type; orange

[www.wago.com/2009-115](http://www.wago.com/2009-115)

/000-012



**Item no.:** 2009-115/000-006

WMB-Inline; for Smart Printer; 1500 pieces on roll; stretchable 5 - 5.2 mm; plain; snap-on type; blue

[www.wago.com/2009-115](http://www.wago.com/2009-115)

/000-006

Subject to changes. Please also observe the further product documentation!

WAGO GmbH & Co. KG

Hansastr. 27

32423 Minden

Phone: +49571 887-0 | Fax: +49571 887-169

Email: [info.de@wago.com](mailto:info.de@wago.com) | Web: [www.wago.com](http://www.wago.com)

Do you have any questions about our products?

We are always happy to take your call at +49 (571) 887-44222.





**Item no.: 2009-115/000-005**

WMB-Inline; for Smart Printer; 1500 pieces on roll; stretchable 5 - 5.2 mm; plain; snap-on type; red

[www.wago.com/2009-115/000-005](http://www.wago.com/2009-115/000-005)

Group marker carrier



**Item no.: 2009-193**

Group marker carrier; gray

[www.wago.com/2009-193](http://www.wago.com/2009-193)



**Item no.: 2009-192**

Group marker carrier; gray

[www.wago.com/2009-192](http://www.wago.com/2009-192)



**Item no.: 2009-191**

Group marker carrier; gray

[www.wago.com/2009-191](http://www.wago.com/2009-191)

Carrier rail

Mounting accessories



**Item no.: 210-197**

Steel carrier rail; 35 x 15 mm; 1.5 mm thick; 2 m long; slotted; similar to EN 60715; silver-colored

[www.wago.com/210-197](http://www.wago.com/210-197)



**Item no.: 210-198**

Copper carrier rail; 35 x 15 mm; 2.3 mm thick; 2 m long; unslotted; according to EN 60715; copper-colored

[www.wago.com/210-198](http://www.wago.com/210-198)



**Item no.: 210-504**

Steel carrier rail; 35 x 7.5 mm; 1 mm thick; 2 m long; slotted; galvanized; according to EN 60715; silver-colored

[www.wago.com/210-504](http://www.wago.com/210-504)



**Item no.: 210-505**

Steel carrier rail; 35 x 7.5 mm; 1 mm thick; 2 m long; unslotted; galvanized; according to EN 60715; silver-colored

[www.wago.com/210-505](http://www.wago.com/210-505)



**Item no.: 210-506**

Steel carrier rail; 35 x 15 mm; 1.5 mm thick; 2 m long; unslotted; galvanized; similar to EN 60715; silver-colored

[www.wago.com/210-506](http://www.wago.com/210-506)



**Item no.: 210-508**

Steel carrier rail; 35 x 15 mm; 1.5 mm thick; 2 m long; slotted; galvanized; similar to EN 60715; silver-colored

[www.wago.com/210-508](http://www.wago.com/210-508)



**Item no.: 210-113**

Steel carrier rail; 35 x 7.5 mm; 1 mm thick; 2 m long; unslotted; according to EN 60715; silver-colored

[www.wago.com/210-113](http://www.wago.com/210-113)



**Item no.: 210-118**

Steel carrier rail; 35 x 15 mm; 2.3 mm thick; 2 m long; unslotted; according to EN 60715; silver-colored

[www.wago.com/210-118](http://www.wago.com/210-118)



**Item no.: 210-112**

Steel carrier rail; 35 x 7.5 mm; 1 mm thick; 2 m long; slotted; according to EN 60715; "Hole width 25 mm; silver-colored

[www.wago.com/210-112](http://www.wago.com/210-112)



**Item no.: 210-114**

Steel carrier rail; 35 x 15 mm; 1.5 mm thick; 2 m long; unslotted; similar to EN 60715; silver-colored

[www.wago.com/210-114](http://www.wago.com/210-114)

**Item no.: 210-115**

Subject to changes. Please also observe the further product documentation!

WAGO GmbH & Co. KG

Hansastr. 27

32423 Minden

Phone: +49571 887-0 | Fax: +49571 887-169

Email: [info.de@wago.com](mailto:info.de@wago.com) | Web: [www.wago.com](http://www.wago.com)

Do you have any questions about our products?

We are always happy to take your call at +49 (571) 887-44222.



Steel carrier rail; 35 x 7.5 mm; 1 mm thick; 2 m long; slotted; according to EN 60715; "Hole width 18 mm; [www.wago.com/210-115](http://www.wago.com/210-115)  
silver-colored

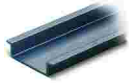

**Item no.: 210-196**  
Aluminum carrier rail; 35 x 8.2 mm; 1.6 mm thick; 2 m long; unslotted; similar to EN 60715; silver-colored [www.wago.com/210-196](http://www.wago.com/210-196)

### Push-in type wire jumper

#### Jumper



**Item no.: 2009-412**  
Push-in type wire jumper; insulated; 60 mm long; black [www.wago.com/2009-412](http://www.wago.com/2009-412)



**Item no.: 2009-414**  
Push-in type wire jumper; 1.5 mm<sup>2</sup>; insulated; 110 mm long; black [www.wago.com/2009-414](http://www.wago.com/2009-414)



**Item no.: 2009-416**  
Push-in type wire jumper; 1.5 mm<sup>2</sup>; insulated; 250 mm long; black [www.wago.com/2009-416](http://www.wago.com/2009-416)



**Item no.: 2009-414/000-005**  
Push-in type wire jumper; 1.5 mm<sup>2</sup>; insulated; 110 mm long; black [www.wago.com/2009-414/000-005](http://www.wago.com/2009-414/000-005)



**Item no.: 2009-414/000-006**  
Push-in type wire jumper; insulated; 110 mm long; black [www.wago.com/2009-414/000-006](http://www.wago.com/2009-414/000-006)

### Tool

#### Operating tool



**Item no.: 210-658**  
Operating tool; Blade: 3.5 x 0.5 mm; with a partially insulated shaft; angled; short; multicoloured [www.wago.com/210-658](http://www.wago.com/210-658)



**Item no.: 210-720**  
Operating tool; Blade: 3.5 x 0.5 mm; with a partially insulated shaft; multicoloured [www.wago.com/210-720](http://www.wago.com/210-720)

### Jumpers

#### Jumper

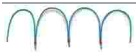

**Item no.: 210-123**  
Wire commoning chain; insulated; blue [www.wago.com/210-123](http://www.wago.com/210-123)



**Item no.: 2002-402**  
Jumper; 2-way; insulated; light gray [www.wago.com/2002-402](http://www.wago.com/2002-402)













**Item no.: 2002-402/000-005**  
Jumper; 2-way; insulated; red [www.wago.com/2002-402/000-005](http://www.wago.com/2002-402/000-005)



**Item no.: 2002-400**  
Continuous jumper; 2-way; insulated; light gray [www.wago.com/2002-400](http://www.wago.com/2002-400)

Subject to changes. Please also observe the further product documentation!

|  |  |  |
|--|--|--|
|     | <b>Item no.: 2002-403</b><br>Jumper; 3-way; insulated; light gray        | <a href="http://www.wago.com/2002-403">www.wago.com/2002-403</a>                 |
|     | <b>Item no.: 2002-404/000-005</b><br>Jumper; 4-way; insulated; red       | <a href="http://www.wago.com/2002-404/000-005">www.wago.com/2002-404/000-005</a> |
|     | <b>Item no.: 2002-403/000-006</b><br>Jumper; 3-way; insulated; blue      | <a href="http://www.wago.com/2002-403/000-006">www.wago.com/2002-403/000-006</a> |
|     | <b>Item no.: 2002-404/000-006</b><br>Jumper; 4-way; insulated; blue      | <a href="http://www.wago.com/2002-404/000-006">www.wago.com/2002-404/000-006</a> |
|     | <b>Item no.: 2002-403/000-005</b><br>Jumper; 3-way; insulated; red       | <a href="http://www.wago.com/2002-403/000-005">www.wago.com/2002-403/000-005</a> |
|    | <b>Item no.: 2002-405/000-005</b><br>Jumper; 5-way; insulated; red       | <a href="http://www.wago.com/2002-405/000-005">www.wago.com/2002-405/000-005</a> |
|     | <b>Item no.: 2002-402/000-006</b><br>Jumper; 2-way; insulated; blue      | <a href="http://www.wago.com/2002-402/000-006">www.wago.com/2002-402/000-006</a> |
|  | <b>Item no.: 2002-405/000-006</b><br>Jumper; 5-way; insulated; blue      | <a href="http://www.wago.com/2002-405/000-006">www.wago.com/2002-405/000-006</a> |
|   | <b>Item no.: 2002-404</b><br>Jumper; 4-way; insulated; light gray        | <a href="http://www.wago.com/2002-404">www.wago.com/2002-404</a>                 |
|  | <b>Item no.: 2002-406/000-006</b><br>Jumper; 6-way; insulated; blue      | <a href="http://www.wago.com/2002-406/000-006">www.wago.com/2002-406/000-006</a> |
|  | <b>Item no.: 2002-406/000-005</b><br>Jumper; 6-way; insulated; red       | <a href="http://www.wago.com/2002-406/000-005">www.wago.com/2002-406/000-005</a> |
|  | <b>Item no.: 2002-406/020-000</b><br>Delta jumper; insulated; light gray | <a href="http://www.wago.com/2002-406/020-000">www.wago.com/2002-406/020-000</a> |
|  | <b>Item no.: 2002-405</b><br>Jumper; 5-way; insulated; light gray        | <a href="http://www.wago.com/2002-405">www.wago.com/2002-405</a>                 |

Subject to changes. Please also observe the further product documentation!



**Item no.: 2002-407/000-005**  
Jumper; 7-way; insulated; red

[www.wago.com/2002-407/000-005](http://www.wago.com/2002-407/000-005)



**Item no.: 2002-408**  
Jumper; 8-way; insulated; light gray

[www.wago.com/2002-408](http://www.wago.com/2002-408)



**Item no.: 2002-408/000-006**  
Jumper; 8-way; insulated; blue

[www.wago.com/2002-408/000-006](http://www.wago.com/2002-408/000-006)



**Item no.: 2002-405/011-000**  
Star point jumper; 3-way; insulated; light gray

[www.wago.com/2002-405/011-000](http://www.wago.com/2002-405/011-000)



**Item no.: 2002-407/000-006**  
Jumper; 7-way; insulated; blue

[www.wago.com/2002-407/000-006](http://www.wago.com/2002-407/000-006)



**Item no.: 2002-408/000-005**  
Jumper; 8-way; insulated; red

[www.wago.com/2002-408/000-005](http://www.wago.com/2002-408/000-005)



**Item no.: 2002-407**  
Jumper; 7-way; insulated; light gray

[www.wago.com/2002-407](http://www.wago.com/2002-407)



**Item no.: 2002-406**  
Jumper; 6-way; insulated; light gray

[www.wago.com/2002-406](http://www.wago.com/2002-406)



**Item no.: 2002-410/000-005**  
Jumper; 10-way; insulated; red

[www.wago.com/2002-410/000-005](http://www.wago.com/2002-410/000-005)



**Item no.: 2002-410/000-006**  
Jumper; 10-way; insulated; blue

[www.wago.com/2002-410/000-006](http://www.wago.com/2002-410/000-006)



**Item no.: 2002-410**  
Jumper; 10-way; insulated; light gray

















[www.wago.com/2002-410](http://www.wago.com/2002-410)

















**Item no.: 2002-409/000-006**  
Jumper; 9-way; insulated; blue

[www.wago.com/2002-409/000-006](http://www.wago.com/2002-409/000-006)

Subject to changes. Please also observe the further product documentation!

|  |  |  |
|--|--|--|
|    | <b>Item no.: 2002-409/000-005</b><br>Jumper; 9-way; insulated; red                   | <a href="http://www.wago.com/2002-409/000-005">www.wago.com/2002-409/000-005</a> |
|    | <b>Item no.: 2002-409</b><br>Jumper; 9-way; insulated; light gray                    | <a href="http://www.wago.com/2002-409">www.wago.com/2002-409</a>                 |
|     | <b>Item no.: 2002-423/000-006</b><br>Continuous jumper; from 1 to 3; insulated; blue | <a href="http://www.wago.com/2002-423/000-006">www.wago.com/2002-423/000-006</a> |
|     | <b>Item no.: 2002-423</b><br>Continuous jumper; from 1 to 3; insulated; light gray   | <a href="http://www.wago.com/2002-423">www.wago.com/2002-423</a>                 |
|     | <b>Item no.: 2002-433</b><br>Jumper; from 1 to 3; insulated; light gray              | <a href="http://www.wago.com/2002-433">www.wago.com/2002-433</a>                 |
|     | <b>Item no.: 2002-434</b><br>Jumper; from 1 to 4; insulated; light gray              | <a href="http://www.wago.com/2002-434">www.wago.com/2002-434</a>                 |
|     | <b>Item no.: 2002-423/000-005</b><br>Continuous jumper; from 1 to 3; insulated; red  | <a href="http://www.wago.com/2002-423/000-005">www.wago.com/2002-423/000-005</a> |
|    | <b>Item no.: 2002-435</b><br>Jumper; from 1 to 5; insulated; light gray              | <a href="http://www.wago.com/2002-435">www.wago.com/2002-435</a>                 |
|   | <b>Item no.: 2002-436</b><br>Jumper; from 1 to 6; insulated; light gray              | <a href="http://www.wago.com/2002-436">www.wago.com/2002-436</a>                 |
|   | <b>Item no.: 2002-437</b><br>Jumper; from 1 to 7; insulated; light gray              | <a href="http://www.wago.com/2002-437">www.wago.com/2002-437</a>                 |
|   | <b>Item no.: 2002-438</b><br>Jumper; from 1 to 8; insulated; light gray              | <a href="http://www.wago.com/2002-438">www.wago.com/2002-438</a>                 |
|   | <b>Item no.: 2002-439</b><br>Jumper; from 1 to 9; insulated; light gray              | <a href="http://www.wago.com/2002-439">www.wago.com/2002-439</a>                 |
|   | <b>Item no.: 2002-440</b><br>Jumper; from 1 to 10; insulated; light gray             | <a href="http://www.wago.com/2002-440">www.wago.com/2002-440</a>                 |
|   | <b>Item no.: 2002-472</b><br>Staggered jumper; 2-way; insulated; light gray          | <a href="http://www.wago.com/2002-472">www.wago.com/2002-472</a>                 |
|   | <b>Item no.: 2002-473</b><br>Staggered jumper; 3-way; insulated; light gray          | <a href="http://www.wago.com/2002-473">www.wago.com/2002-473</a>                 |
|  | <b>Item no.: 2002-475/011-000</b><br>Staggered jumper; 3-way; insulated; light gray  | <a href="http://www.wago.com/2002-475/011-000">www.wago.com/2002-475/011-000</a> |

Subject to changes. Please also observe the further product documentation!

|   |  |  |
|---|--|--|
|      | <b>Item no.: 2002-475</b><br>Staggered jumper; 5-way; insulated; light gray                      | <a href="http://www.wago.com/2002-475">www.wago.com/2002-475</a>                 |
|     | <b>Item no.: 2002-476</b><br>Staggered jumper; 6-way; insulated; light gray                      | <a href="http://www.wago.com/2002-476">www.wago.com/2002-476</a>                 |
|      | <b>Item no.: 2002-474</b><br>Staggered jumper; 4-way; insulated; light gray                      | <a href="http://www.wago.com/2002-474">www.wago.com/2002-474</a>                 |
|     | <b>Item no.: 2002-477</b><br>Staggered jumper; 7-way; insulated; light gray                      | <a href="http://www.wago.com/2002-477">www.wago.com/2002-477</a>                 |
|     | <b>Item no.: 2002-473/011-000</b><br>Staggered jumper; 2-way; from 1 to 3; insulated; light gray | <a href="http://www.wago.com/2002-473/011-000">www.wago.com/2002-473/011-000</a> |
|     | <b>Item no.: 2002-479</b><br>Staggered jumper; 9-way; insulated; light gray                      | <a href="http://www.wago.com/2002-479">www.wago.com/2002-479</a>                 |
|     | <b>Item no.: 2002-478</b><br>Staggered jumper; 8-way; insulated; light gray                      | <a href="http://www.wago.com/2002-478">www.wago.com/2002-478</a>                 |
|    | <b>Item no.: 2002-479/011-000</b><br>Staggered jumper; insulated; light gray                     | <a href="http://www.wago.com/2002-479/011-000">www.wago.com/2002-479/011-000</a> |
|   | <b>Item no.: 2002-480</b><br>Staggered jumper; 10-way; insulated; light gray                     | <a href="http://www.wago.com/2002-480">www.wago.com/2002-480</a>                 |
|   | <b>Item no.: 2002-477/011-000</b><br>Staggered jumper; insulated; light gray                     | <a href="http://www.wago.com/2002-477/011-000">www.wago.com/2002-477/011-000</a> |
|   | <b>Item no.: 2002-481/011-000</b><br>Staggered jumper; insulated; light gray                     | <a href="http://www.wago.com/2002-481/011-000">www.wago.com/2002-481/011-000</a> |
|   | <b>Item no.: 2002-481</b><br>Staggered jumper; 11-way; insulated; light gray                     | <a href="http://www.wago.com/2002-481">www.wago.com/2002-481</a>                 |
|   | <b>Item no.: 2002-482</b><br>Staggered jumper; 12-way; insulated; light gray                     | <a href="http://www.wago.com/2002-482">www.wago.com/2002-482</a>                 |
|   | <b>Item no.: 210-103</b><br>Wire commoning chain; insulated; black                               | <a href="http://www.wago.com/210-103">www.wago.com/210-103</a>                   |
|  | <b>Item no.: 2002-424/000-006</b><br>Continuous jumper; from 1 to 4; insulated; blue             | <a href="http://www.wago.com/2002-424/000-006">www.wago.com/2002-424/000-006</a> |

Subject to changes. Please also observe the further product documentation!



## Downloads

### Documentation

#### Bid Text

|                                    |             |                 |          |
|------------------------------------|-------------|-----------------|----------|
| 2002-2221/1000-434<br>X81 - Datei  | 2019 Apr 23 | xml<br>4.0 kB   | Download |
| 2002-2221/1000-434<br>docx - Datei | 2019 Apr 23 | docx<br>15.8 kB | Download |

#### Additional Information

|   |  |               |          |
|---|--|---------------|----------|
| Technical Section<br>Technical explanations |  | pdf<br>2.2 MB | Download |
|---|--|---------------|----------|

## CAD/CAE-Data

### CAD data

|                                 |  |     |          |
|---------------------------------|--|-----|----------|
| 2D/3D Models 2002-2221/1000-434 |  | URL | Download |
|---------------------------------|--|-----|----------|

### CAE data

|                                      |  |     |          |
|--------------------------------------|--|-----|----------|
| EPLAN Data Portal 2002-2221/1000-434 |  | URL | Download |
| WSCAD Universe 2002-2221/1000-434    |  | URL | Download |
| ZUKEN Portal 2002-2221/1000-434      |  | URL | Download |
| WSCAD Universe 2002-2221/1000-434    |  | URL | Download |
| EPLAN Data Portal 2002-2221/1000-434 |  | URL | Download |

## Environmental Product Compliance

### Compliance Search

|  |  |     |          |
|--|--|-----|----------|
| Environmental Product Compliance 2002-2221/1000-434<br>Component terminal block; double-deck; LED (red); 24 VDC; for DIN-rail 35 x 15 and 35 x 7.5; 2.5 mm <sup>2</sup> ; Push-in CAGE CLAMP®; 2,50 mm <sup>2</sup> ; gray |  | URL | Download |
|--|--|-----|----------|

Subject to changes. Please also observe the further product documentation!

## Installation Notes

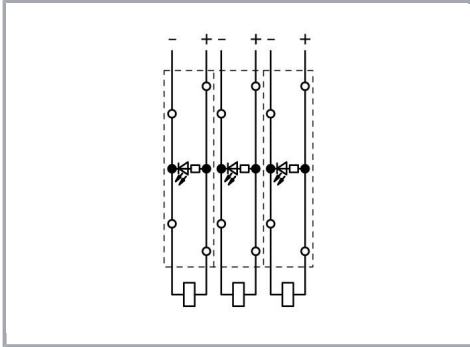

Circuit-related voltage indications can be created using the following terminal blocks:

2002-2221/1000-434 or 2002-2221/1000-413

## Product family

### TOPJOB® S

TOPJOB® S: In various industrial applications and modern building installations, WAGO's wide and versatile range of rail-mount terminal blocks provides more than just reliable electrical connections.

[Show all products from the family](#)

Subject to changes. Please also observe the further product documentation!