

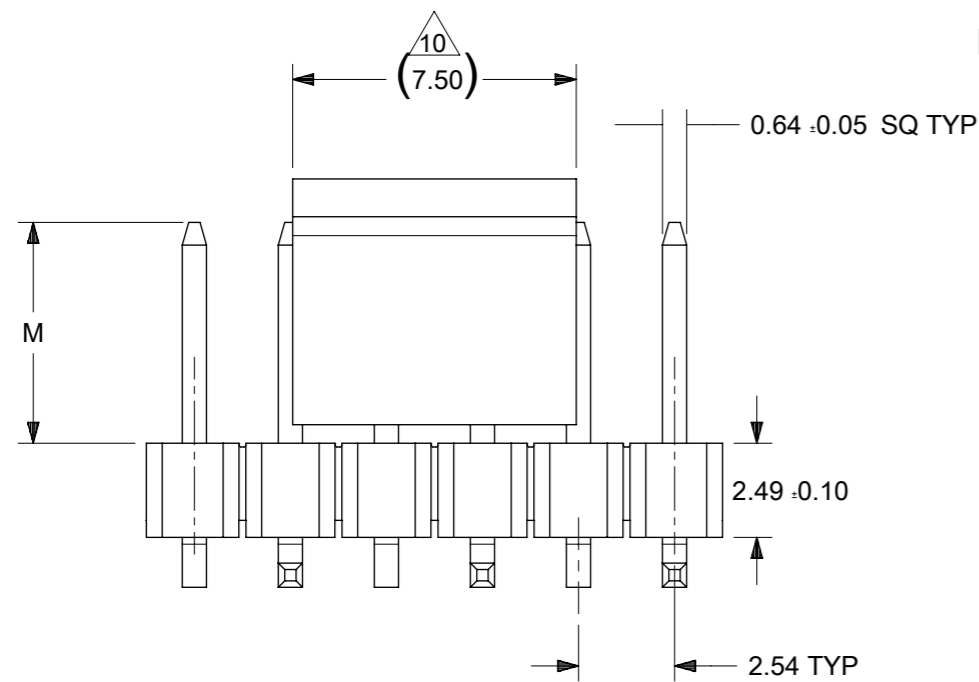

RECOMMENDED PCB LAYOUT: COMPONENT SIDE

NOTES:

- MATERIAL:  
HSG: NYLON, GLASS-FILLED, UL94V-0, COLOR: BLACK  
CAP: NYLON, GLASS-FILLED, UL94V-0, COLOR: BLACK  
PIN: 0.64MM SQ, COPPER ALLOY
- PLATING TYPE:  
(1) GOLD FLASH OVER  
1.25µm MIN. NICKEL OVERALL.  
(2) GOLD FLASH ON CONTACT AND  
2.50µm MIN. TIN ON SOLDER TAIL OVER  
1.25µm MIN. NICKEL OVERALL.  
(4) 0.38µm MIN. GOLD PLATE ON CONTACT AND  
2.00µm MIN. TIN ON SOLDER TAIL OVER  
1.25µm MIN. NICKEL OVERALL.  
(5) 0.75µm MIN. GOLD PLATE ON CONTACT AND  
2.00µm MIN. TIN ON SOLDER TAIL OVER  
1.25µm MIN. NICKEL OVERALL.  
(6) 2.50µm MIN. TIN OVERALL  
1.25µm MIN. NICKEL OVERALL
- PRODUCT SPECIFICATION: PS-87920-019
- PACKAGING TYPE: SEE TABLE
- PACKAGING SPEC:  
TUBE WITH CAP VERSION: PK-89990-558  
TUBE W/O CAP VERSION: PK-89990-545  
TRAY W/O CAP: PK-89990-489  
EMBOSS TAPE WITH CAP: PK-89990-486 AND PK-87898-400
- WAFER TO BE FLAT WITHIN 0.003 mm/mm
- BEND DEPRESSION IS ACCEPTED SO LONG AS IT DOES NOT AFFECT THE OVERALL COPLANARITY OF TAIL
- COPLANARITY IS TO BE MEASURED BY RESTING THE SOLDER TAIL ON A FLAT SURFACE
- IRREGULAR CIRCUIT CUTOFF WITHIN BREAKAWAY SECTION IS PERMISSIBLE. CUTTING OR CHIPPING OF THE MAIN BODY IS NOT ACCEPTABLE
- CAP LOCATION IS CENTERED ALONG THE MATING ENDS AS SHOWN. TOP SURFACE OF CAP TO BE FLAT FOR THE PURPOSE OF PICK & PLACE BY VACUUM SUCTION NOZZLE
- RECOMMENDED PCB THICKNESS IS 1.60mm±0.10
- THE ABOVE CKT 6 IS FOR ILLUSTRATION PURPOSE ONLY
- TUBE LENGTH AS PER STANDARD 560mm



THIS DRAWING CONTAINS INFORMATION THAT IS PROPRIETARY TO MOLEX ELECTRONIC TECHNOLOGIES, LLC AND SHOULD NOT BE USED WITHOUT WRITTEN PERMISSION									
DIMENSION UNITS		SCALE		CURRENT REV DESC:					
mm		NTS		<p><b>molex</b></p> <p>CUSTOM HEADER 2.54MM PITCH SINGLE ROW SINGLE WAFER SMT HEADER</p> <p>PRODUCT CUSTOMER DRAWING</p> <p>DOCUMENT NUMBER: SD-87898-001   DOC TYPE: PSD   DOC PART: 000   REVISION: B26</p> <p>MATERIAL NUMBER: SEE TABLE   CUSTOMER: GENERAL MARKET   SHEET NUMBER: 1 OF 21</p>					
GENERAL TOLERANCES (UNLESS SPECIFIED)									
		MM	INCH						
4 PLACES	±								
3 PLACES	±								
2 PLACES	±	0.2							
1 PLACE	±								
0 PLACES	±								
ANGULAR TOL		± 3.0°		<p>EC NO: 745488</p> <p>DRWN: SUAIFR 2023/02/15</p> <p>CHK'D: SUAIFR 2023/04/10</p> <p>APPR: MRAMAKRISHNA 2023/04/10</p> <p>INITIAL REVISION:</p> <p>DRWN: GGUNAGI 2016/11/09</p> <p>APPR: ISHWARG 2016/12/06</p>					
DRAFT WHERE APPLICABLE MUST REMAIN WITHIN DIMENSIONS				THIRD ANGLE PROJECTION		DRAWING		SERIES	
						A3-SIZE		87898	

PACKAGING OPTION PART NO.						CKT SIZE	VOID POSITION	PLATING TYPE	DIMENSION					CAP (SEE SHEET-16)
TRAY WITHOUT CAP	TRAY WITH CAP	TUBE WITHOUT CAP	TUBE WITH CAP	TAPE & REEL WITHOUT CAP	TAPE & REEL WITH CAP				A	B	G	F	M	
87898-0301	-----	-----	-----	-----	-----	3	----	1	7.62	5.08	10.81	9.65	5.84	1
87898-0302	-----	-----	-----	-----	-----	3	----	2	7.62	5.08	10.81	9.65	5.84	1
87898-0304	-----	-----	-----	-----	87898-0314	3	----	4	7.62	5.08	10.81	9.65	5.84	1
87898-0305	-----	-----	-----	-----	87898-0315	3	----	5	7.62	5.08	10.81	9.65	5.84	1
87898-0306	-----	-----	-----	-----	87898-0316	3	----	6	7.62	5.08	10.81	9.65	5.84	1
87898-0307	-----	-----	-----	-----	87898-0320	3	----	6	7.62	5.08	10.81	9.65	5.84	1
-----	-----	-----	-----	-----	87898-0317	3	-----	6	7.62	5.08	10.81	9.65	5.84	1
-----	-----	-----	-----	-----	87898-0321	3	-----	6	7.62	5.08	10.81	9.65	5.84	1
-----	-----	-----	-----	-----	87898-0318	3	----	5	7.62	5.08	10.81	9.65	5.84	1
-----	-----	-----	-----	-----	87898-0310	3	-----	6	7.62	5.08	14.91	13.91	10.10	1
-----	-----	-----	-----	-----	87898-0309	3	-----	6	7.62	5.08	14.81	13.81	10.00	1
-----	-----	87898-0370	-----	-----	-----	3	-----	6	7.62	5.08	----	13.91	10.10	1

REFER TO LAST SHEET FOR 2CKT SIZE

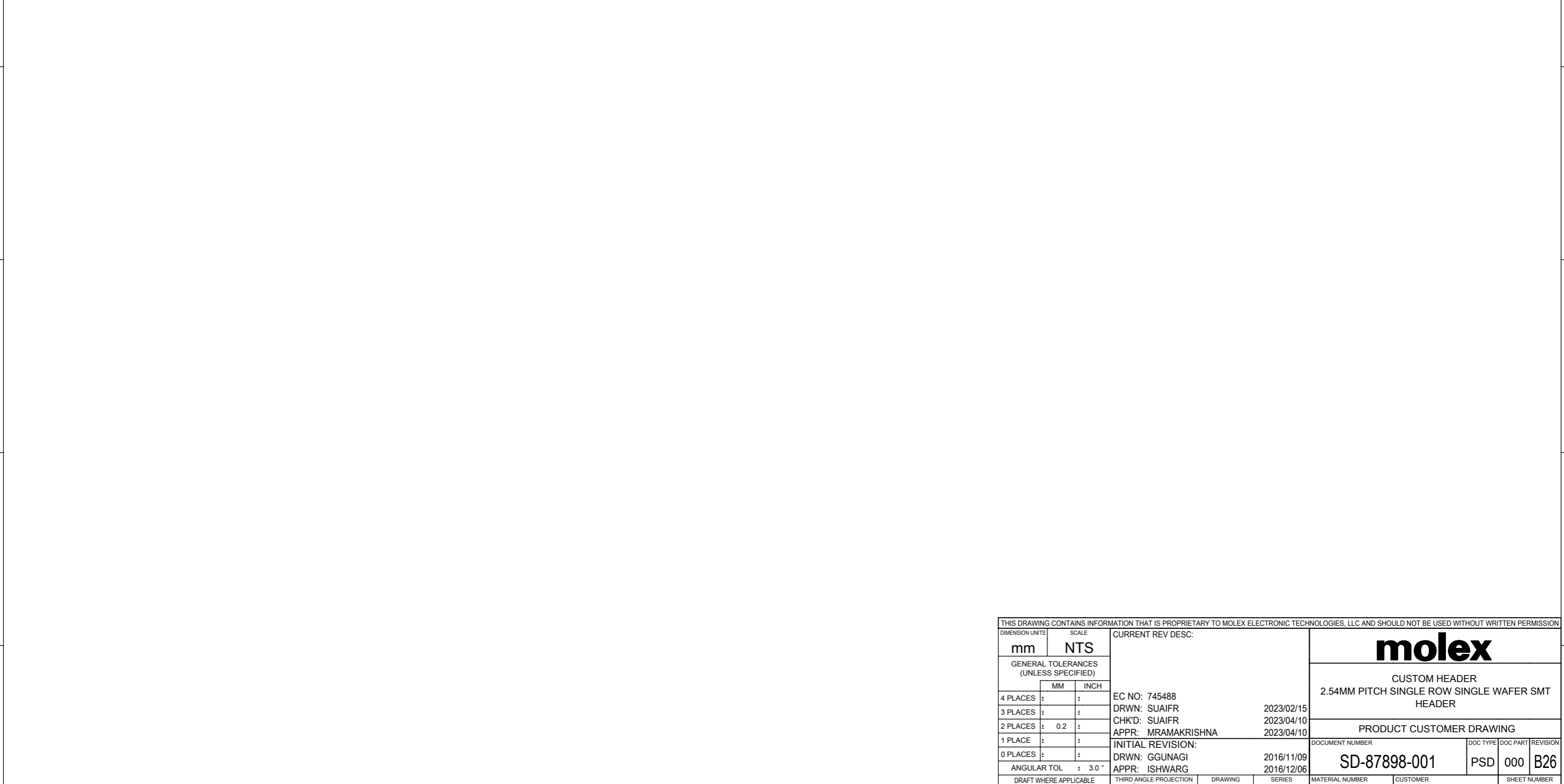

THIS DRAWING CONTAINS INFORMATION THAT IS PROPRIETARY TO MOLEX ELECTRONIC TECHNOLOGIES, LLC AND SHOULD NOT BE USED WITHOUT WRITTEN PERMISSION																	
DIMENSION UNITS		SCALE		CURRENT REV DESC:													
mm		NTS															
GENERAL TOLERANCES (UNLESS SPECIFIED)				EC NO: 745488 DRWN: SUAIFR 2023/02/15 CHK'D: SUAIFR 2023/04/10 APPR: MRAMAKRISHNA 2023/04/10 INITIAL REVISION: DRWN: GGUNAGI 2016/11/09 APPR: ISHWARG 2016/12/06						CUSTOM HEADER							
										2.54MM PITCH SINGLE ROW SINGLE WAFER SMT HEADER							
										PRODUCT CUSTOMER DRAWING							
										DOCUMENT NUMBER		DOC TYPE		DOC PART		REVISION	
										SD-87898-001		PSD		000		B26	
DRAFT WHERE APPLICABLE MUST REMAIN WITHIN DIMENSIONS				THIRD ANGLE PROJECTION		DRAWING		SERIES		MATERIAL NUMBER		CUSTOMER		SHEET NUMBER			
						A3-SIZE		87898		SEE TABLE		GENERAL MARKET		2 OF 21			

DOCUMENT STATUS	P1	RELEASE DATE	2023/04/10	07:46:21
-----------------	----	--------------	------------	----------

10		9		8		7		6		5		4		3		2		1	
PACKAGING OPTION PART NO.						CKT SIZE	VOID POSITION	PLATING TYPE	MODIFIED MATING CKT	MODIFIED MATING LENGTH	DIMENSION					CAP (SEE SHEET-16)			
TRAY WITHOUT CAP	TRAY WITH CAP	TUBE WITHOUT CAP	TUBE WITH CAP	TAPE & REEL WITHOUT CAP	TAPE & REEL WITH CAP						A	B	G	F	M				
F	-----	-----	87898-0421	87898-0431	-----	87898-0451	4	-----	1	-----	-----	10.16	7.62	10.81	9.65	5.84	1		
	-----	-----	87898-0422	87898-0432	-----	87898-0452	4	-----	2	-----	-----	10.16	7.62	10.81	9.65	5.84	1		
	-----	-----	87898-0424	87898-0434	-----	87898-0454	4	-----	4	-----	-----	10.16	7.62	10.81	9.65	5.84	1		
	-----	-----	87898-0425	87898-0435	-----	87898-0455	4	-----	5	-----	-----	10.16	7.62	10.81	9.65	5.84	1		
	-----	-----	87898-0426	87898-0436	-----	87898-0456	4	-----	6	-----	-----	10.16	7.62	10.81	9.65	5.84	1		
	-----	-----	87898-0428	87898-0437	-----	87898-0460	4	-----	6	-----	-----	10.16	7.62	10.81	9.65	5.84	1		
	-----	-----	-----	-----	-----	87898-0457	4	-----	6	-----	-----	10.16	7.62	10.81	9.65	5.84	1		
	-----	-----	-----	-----	-----	87898-0458	4	-----	5	-----	-----	10.16	7.62	10.81	9.65	5.84	1		
	-----	-----	-----	-----	-----	87898 - 0480	4	CKT# 4	5	-----	-----	10.16	7.62	14.70	13.65	9.84	1		
	-----	-----	-----	-----	-----	87898 - 0481	4	-----	5	CKT # 1, 2 & 3	1.00	10.16	7.62	17.70	16.65	12.84	1		
E	87898 - 0482	-----	-----	-----	-----	-----	4	-----	---	CKT # 1, 2 & 3	1.00	10.16	7.62	---	16.65	12.84	1		
	-----	-----	-----	-----	-----	87898 - 0483	4	-----	---	CKT # 1, 2 & 3	1.00	10.16	7.62	14.70	13.65	9.84	1		
	-----	-----	87898-0427	-----	-----	-----	4	-----	---	-----	-----	10.16	7.62	---	11.87	8.06	1		
	-----	-----	-----	-----	-----	87898 - 0488	4	-----	5	-----	-----	10.16	7.62	17.78	16.74	12.93	1		
	-----	-----	87898-0521	87898-0531	-----	87898-0551	5	-----	1	-----	-----	12.70	10.16	10.81	9.65	5.84	1		
	-----	-----	87898-0522	87898-0532	-----	87898-0552	5	-----	2	-----	-----	12.70	10.16	10.81	9.65	5.84	1		
	-----	-----	87898-0524	87898-0534	-----	87898-0554	5	-----	4	-----	-----	12.70	10.16	10.81	9.65	5.84	1		
	-----	-----	87898-0525	87898-0535	-----	87898-0555	5	-----	5	-----	-----	12.70	10.16	10.81	9.65	5.84	1		
D	-----	-----	87898-0526	87898-0536	87898-0583	87898-0556	5	-----	6	-----	-----	12.70	10.16	10.81	9.65	5.84	1		
	-----	-----	87898-0528	87898-0538	87898-0584	87898-0558	5	-----	6	-----	-----	12.70	10.16	10.81	9.65	5.84	1		
	87898-0581	-----	-----	-----	-----	-----	5	-----	4	-----	-----	12.70	10.16	---	24.18	20.25	1		
	-----	-----	-----	-----	-----	87898-0576	5	-----	5	-----	-----	12.70	10.16	14.35	13.31	9.50	1		
	-----	-----	87898-0621	87898-0631	-----	87898-0651	6	-----	1	-----	-----	15.24	12.70	10.81	9.65	5.84	1		
	-----	-----	87898-0622	87898-0632	-----	87898-0652	6	-----	2	-----	-----	15.24	12.70	10.81	9.65	5.84	1		
	-----	-----	87898-0624	87898-0634	-----	87898-0654	6	-----	4	-----	-----	15.24	12.70	10.81	9.65	5.84	1		
	-----	-----	87898-0625	87898-0635	-----	87898-0655	6	-----	5	-----	-----	15.24	12.70	10.81	9.65	5.84	1		
C	-----	-----	87898-0626	87898-0636	-----	87898-0656	6	-----	6	-----	-----	15.24	12.70	10.81	9.65	5.84	1		
	-----	-----	87898-0628	87898-0638	-----	87898-0658	6	-----	6	-----	-----	15.24	12.70	10.81	9.65	5.84	1		
	87898-0607	-----	-----	-----	-----	87898-0657	6	-----	6	-----	-----	15.24	12.70	16.47	15.31	11.50	1		
	-----	-----	-----	-----	-----	87898-0605	6	-----	5	-----	-----	15.24	12.70	12.98	11.94	8.13	1		
	-----	-----	87898-0604	-----	-----	-----	6	-----	5	-----	-----	15.24	12.70	---	13.31	9.50	1		

B										B									
A										A									

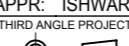
THIS DRAWING CONTAINS INFORMATION THAT IS PROPRIETARY TO MOLEX ELECTRONIC TECHNOLOGIES, LLC AND SHOULD NOT BE USED WITHOUT WRITTEN PERMISSION																					
DIMENSION UNITS		SCALE		CURRENT REV DESC:																	
mm		NTS		EC NO: 745488 DRWN: SUAIFR CHK'D: SUAIFR APPR: MRAMAKRISHNA INITIAL REVISION: DRWN: GGUNAGI APPR: ISHWARG										CUSTOM HEADER 2.54MM PITCH SINGLE ROW SINGLE WAFER SMT HEADER							
GENERAL TOLERANCES (UNLESS SPECIFIED)										2023/02/15 2023/04/10 2023/04/10				PRODUCT CUSTOMER DRAWING							
4 PLACES ±		MM								INCH		2016/11/09		DOCUMENT NUMBER		DOC TYPE		DOC PART		REVISION	
3 PLACES ±		0.2								±		2016/12/06		SD-87898-001		PSD		000		B26	
2 PLACES ±		±		±		±		MATERIAL NUMBER		CUSTOMER		SHEET NUMBER									
1 PLACE ±		±		±		±		SEE TABLE		GENERAL MARKET		3 OF 21									
0 PLACES ±		±		±		±		A3-SIZE		87898											
ANGULAR TOL ± 3.0°				THIRD ANGLE PROJECTION		DRAWING		SERIES		MATERIAL NUMBER		CUSTOMER		SHEET NUMBER							
DRAFT WHERE APPLICABLE MUST REMAIN WITHIN DIMENSIONS						A3-SIZE		87898		SEE TABLE		GENERAL MARKET		3 OF 21							

10		9		8		7		6		5		4		3		2		1	
PACKAGING OPTION PART NO.										DIMENSION					CAP				
TRAY WITHOUT CAP	TRAY WITH CAP	TUBE WITHOUT CAP	TUBE WITH CAP	TAPE & REEL WITHOUT CAP	TAPE & REEL WITH CAP	CKT SIZE	VOID POSITION	PLATING TYPE	A	B	G	F	M	(SEE SHEET-16)					
-----	-----	87898-0721	87898-0731	-----	87898-0751	7	-----	1	17.78	15.24	10.81	9.65	5.84	1					
-----	-----	87898-0722	87898-0732	-----	87898-0752	7	-----	2	17.78	15.24	10.81	9.65	5.84	1					
-----	-----	87898-0724	87898-0734	-----	87898-0754	7	-----	4	17.78	15.24	10.81	9.65	5.84	1					
-----	-----	87898-0725	87898-0735	-----	87898-0755	7	-----	5	17.78	15.24	10.81	9.65	5.84	1					
-----	-----	87898-0726	87898-0736	-----	87898-0756	7	-----	6	17.78	15.24	10.81	9.65	5.84	1					
-----	-----	87898-0727	87898-0737	-----	87898-0758	7	-----	6	17.78	15.24	10.81	9.65	5.84	1					
-----	-----	-----	-----	87898-0757	-----	7	-----	6	17.78	15.24	---	9.65	5.84	1					
-----	-----	-----	-----	87898-0759	-----	7	-----	6	17.78	15.24	---	9.65	5.84	1					
-----	-----	87898-0720	-----	-----	-----	7	-----	5	17.78	15.24	---	9.81	6.00	1					
-----	-----	87898-0767	-----	-----	-----	7	-----	5	17.78	15.24	---	13.81	10.00	1					
-----	-----	87898-0821	87898-0831	-----	87898-0851	8	-----	1	20.32	17.78	10.81	9.65	5.84	1					
-----	-----	87898-0822	87898-0832	-----	87898-0852	8	-----	2	20.32	17.78	10.81	9.65	5.84	1					
-----	-----	87898-0824	87898-0834	-----	87898-0854	8	-----	4	20.32	17.78	10.81	9.65	5.84	1					
-----	-----	87898-0825	87898-0835	-----	87898-0855	8	-----	5	20.32	17.78	10.81	9.65	5.84	1					
-----	-----	87898-0826	87898-0836	-----	87898-0856	8	-----	6	20.32	17.78	10.81	9.65	5.84	1					
-----	-----	87898-0827	87898-0837	-----	87898-0857	8	-----	6	20.32	17.78	10.81	9.65	5.84	1					
87898-0881	-----	-----	-----	-----	-----	8	-----	4	20.32	17.78	---	21.84	17.91	1					
-----	-----	87898-0921	87898-0931	-----	87898-0951	9	-----	1	22.86	20.32	10.81	9.65	5.84	1					
-----	-----	87898-0922	87898-0932	-----	87898-0952	9	-----	2	22.86	20.32	10.81	9.65	5.84	1					
-----	-----	87898-0924	87898-0934	-----	87898-0954	9	-----	4	22.86	20.32	10.81	9.65	5.84	1					
-----	-----	87898-0925	87898-0935	-----	87898-0955	9	-----	5	22.86	20.32	10.81	9.65	5.84	1					
-----	-----	87898-0926	87898-0936	-----	87898-0956	9	-----	6	22.86	20.32	10.81	9.65	5.84	1					

THIS DRAWING CONTAINS INFORMATION THAT IS PROPRIETARY TO MOLEX ELECTRONIC TECHNOLOGIES, LLC AND SHOULD NOT BE USED WITHOUT WRITTEN PERMISSION																	
DIMENSION UNITS		SCALE		CURRENT REV DESC:													
mm		NTS		 CUSTOMER HEADER 2.54MM PITCH SINGLE ROW SINGLE WAFER SMT HEADER PRODUCT CUSTOMER DRAWING													
GENERAL TOLERANCES (UNLESS SPECIFIED)																	
		MM	INCH														
4 PLACES	±		±														
3 PLACES	±		±														
2 PLACES	±	0.2	±														
1 PLACE	±		±														
0 PLACES	±		±														
ANGULAR TOL ± 3.0°				EC NO: 745488		DRWN: SUIAIFR		2023/02/15		CHK'D: SUIAIFR		2023/04/10		APPR: MRAMAKRISHNA		2023/04/10	
DRAFT WHERE APPLICABLE MUST REMAIN WITHIN DIMENSIONS				THIRD ANGLE PROJECTION		DRAWING		SERIES		MATERIAL NUMBER		CUSTOMER		SHEET NUMBER			
						A3-SIZE		87898		SEE TABLE		GENERAL MARKET		4 OF 21			

DOCUMENT STATUS	P1	RELEASE DATE	2023/04/10	07:46:21
-----------------	----	--------------	------------	----------

PACKAGING OPTION PART NO.										DIMENSION					CAP (SEE SHEET-16)
TRAY WITHOUT CAP	TRAY WITH CAP	TUBE WITHOUT CAP	TUBE WITH CAP	TAPE & REEL WITHOUT CAP	TAPE & REEL WITH CAP	CKT SIZE	VOID POSITION	PLATING TYPE	A	B	G	F	M		
-----	-----	87898-1021	87898-1031	-----	87898-1051	10	-----	1	25.40	22.86	10.81	9.65	5.84	1	
-----	-----	87898-1022	87898-1032	-----	87898-1052	10	-----	2	25.40	22.86	10.81	9.65	5.84	1	
-----	-----	87898-1024	87898-1034	-----	87898-1054	10	-----	4	25.40	22.86	10.81	9.65	5.84	1	
-----	-----	87898-1025	87898-1035	-----	87898-1055	10	-----	5	25.40	22.86	10.81	9.65	5.84	1	
-----	-----	87898-1026	87898-1036	-----	87898-1056	10	-----	6	25.40	22.86	10.81	9.65	5.84	1	
-----	-----	87898-1027	87898-1037	-----	87898-1057	10	-----	6	25.40	22.86	10.81	9.65	5.84	1	
-----	-----	87898-1003	-----	-----	-----	10	-----	5	25.40	22.86	---	9.81	6.00	1	
-----	-----	87898-1121	87898-1131	-----	87898-1151	11	-----	1	27.94	25.40	10.81	9.65	5.84	1	
-----	-----	87898-1122	87898-1132	-----	87898-1152	11	-----	2	27.94	25.40	10.81	9.65	5.84	1	
-----	-----	87898-1124	87898-1134	-----	87898-1154	11	-----	4	27.94	25.40	10.81	9.65	5.84	1	
-----	-----	87898-1125	87898-1135	-----	87898-1155	11	-----	5	27.94	25.40	10.81	9.65	5.84	1	
-----	-----	87898-1126	87898-1136	-----	87898-1156	11	-----	6	27.94	25.40	10.81	9.65	5.84	1	
-----	-----	87898-1221	87898-1231	-----	87898-1251	12	-----	1	30.48	27.94	10.81	9.65	5.84	1	
-----	-----	87898-1222	87898-1232	-----	87898-1252	12	-----	2	30.48	27.94	10.81	9.65	5.84	1	
-----	-----	87898-1224	87898-1234	-----	87898-1254	12	-----	4	30.48	27.94	10.81	9.65	5.84	1	
-----	-----	87898-1225	87898-1235	-----	87898-1255	12	-----	5	30.48	27.94	10.81	9.65	5.84	1	
-----	-----	87898-1226	87898-1236	-----	87898-1256	12	-----	6	30.48	27.94	10.81	9.65	5.84	1	

THIS DRAWING CONTAINS INFORMATION THAT IS PROPRIETARY TO MOLEX ELECTRONIC TECHNOLOGIES, LLC AND SHOULD NOT BE USED WITHOUT WRITTEN PERMISSION

DIMENSION UNITS	SCALE	CURRENT REV DESC:	<b>molex</b>			
mm	NTS					
GENERAL TOLERANCES (UNLESS SPECIFIED)		EC NO: 745488 DRWN: SUAIFR CHK'D: SUAIFR APPR: MRAMAKRISHNA INITIAL REVISION: DRWN: GGUNAGI APPR: ISHWARG	2023/02/15 2023/04/10 2023/04/10 2016/11/09 2016/12/06			
	MM INCH					
4 PLACES	± ±					
3 PLACES	± ±					
2 PLACES	± 0.2 ±					
1 PLACE	± ±					
0 PLACES	± ±	DOCUMENT NUMBER	DOC TYPE	DOC PART	REVISION	
ANGULAR TOL	± 3.0°	SD-87898-001	PSD	000	B26	
DRAFT WHERE APPLICABLE MUST REMAIN WITHIN DIMENSIONS	THIRD ANGLE PROJECTION	DRAWING	SERIES	MATERIAL NUMBER	CUSTOMER	SHEET NUMBER
		A3-SIZE	87898	SEE TABLE	GENERAL MARKET	5 OF 21

DOCUMENT STATUS	P1	RELEASE DATE	2023/04/10	07:46:21
-----------------	----	--------------	------------	----------

PACKAGING OPTION PART NO.										DIMENSION					CAP (SEE SHEET-16)
TRAY WITHOUT CAP	TRAY WITH CAP	TUBE WITHOUT CAP	TUBE WITH CAP	TAPE & REEL WITHOUT CAP	TAPE & REEL WITH CAP	CKT SIZE	VOID POSITION	PLATING TYPE	A	B	G	F	M		
-----	-----	87898-1321	87898-1331	-----	87898-1351	13	-----	1	33.02	30.48	10.81	9.65	5.84	1	
-----	-----	87898-1322	87898-1332	-----	87898-1352	13	-----	2	33.02	30.48	10.81	9.65	5.84	1	
-----	-----	87898-1324	87898-1334	-----	87898-1354	13	-----	4	33.02	30.48	10.81	9.65	5.84	1	
-----	-----	87898-1325	87898-1335	-----	87898-1355	13	-----	5	33.02	30.48	10.81	9.65	5.84	1	
-----	-----	87898-1326	87898-1336	-----	87898-1356	13	-----	6	33.02	30.48	10.81	9.65	5.84	1	
-----	-----	87898-1421	87898-1431	-----	87898-1451	14	-----	1	35.56	33.02	10.81	9.65	5.84	1	
-----	-----	87898-1422	87898-1432	-----	87898-1452	14	-----	2	35.56	33.02	10.81	9.65	5.84	1	
-----	-----	87898-1424	87898-1434	-----	87898-1454	14	-----	4	35.56	33.02	10.81	9.65	5.84	1	
-----	-----	87898-1425	87898-1435	-----	87898-1455	14	-----	5	35.56	33.02	10.81	9.65	5.84	1	
-----	-----	87898-1426	87898-1436	-----	87898-1456	14	-----	6	35.56	33.02	10.81	9.65	5.84	1	
-----	-----	87898-1427	87898-1437	-----	87898-1457	14	-----	6	35.56	33.02	10.81	9.65	5.84	1	
-----	-----	87898-1521	87898-1531	-----	87898-1551	15	-----	1	38.10	35.56	10.81	9.65	5.84	1	
-----	-----	87898-1522	87898-1532	-----	87898-1552	15	-----	2	38.10	35.56	10.81	9.65	5.84	1	
-----	-----	87898-1524	87898-1534	-----	87898-1554	15	-----	4	38.10	35.56	10.81	9.65	5.84	1	
-----	-----	87898-1525	87898-1535	-----	87898-1555	15	-----	5	38.10	35.56	10.81	9.65	5.84	1	
-----	-----	87898-1526	87898-1536	-----	87898-1556	15	-----	6	38.10	35.56	10.81	9.65	5.84	1	

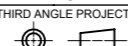
THIS DRAWING CONTAINS INFORMATION THAT IS PROPRIETARY TO MOLEX ELECTRONIC TECHNOLOGIES, LLC AND SHOULD NOT BE USED WITHOUT WRITTEN PERMISSION											
DIMENSION UNITS		SCALE		CURRENT REV DESC:							
mm		NTS									
GENERAL TOLERANCES (UNLESS SPECIFIED)				EC NO: 745488 DRWN: SUAIFR APPR: MRAMAKRISHNA INITIAL REVISION: DRWN: GGUNAGI APPR: ISHWARG				2023/02/15 2023/04/10 2023/04/10 2016/11/09 2016/12/06			
ANGULAR TOL ± 3.0°				DOCUMENT NUMBER		DOC TYPE		DOC PART		REVISION	
DRAFT WHERE APPLICABLE MUST REMAIN WITHIN DIMENSIONS				DRAWING		SERIES		MATERIAL NUMBER		CUSTOMER	
				A3-SIZE		87898		SEE TABLE		GENERAL MARKET	
								SD-87898-001		PSD 000 B26	
										6 OF 21	

DOCUMENT STATUS	P1	RELEASE DATE	2023/04/10	07:46:21
-----------------	----	--------------	------------	----------

PACKAGING OPTION PART NO.										DIMENSION					CAP (SEE SHEET-16)
TRAY WITHOUT CAP	TRAY WITH CAP	TUBE WITHOUT CAP	TUBE WITH CAP	TAPE & REEL WITHOUT CAP	TAPE & REEL WITH CAP	CKT SIZE	VOID POSITION	PLATING TYPE	A	B	G	F	M		
-----	-----	87898-1621	87898-1631	-----	87898-1651	16	-----	1	40.64	38.10	10.81	9.65	5.84	1	
-----	-----	87898-1622	87898-1632	-----	87898-1652	16	-----	2	40.64	38.10	10.81	9.65	5.84	1	
-----	-----	87898-1624	87898-1634	-----	87898-1654	16	-----	4	40.64	38.10	10.81	9.65	5.84	1	
-----	-----	87898-1625	87898-1635	-----	87898-1655	16	-----	5	40.64	38.10	10.81	9.65	5.84	1	
-----	-----	87898-1626	87898-1636	-----	87898-1656	16	-----	6	40.64	38.10	10.81	9.65	5.84	1	
-----	-----	87898-1627	87898-1637	-----	87898-1657	16	-----	6	40.64	38.10	10.81	9.65	5.84	1	
-----	-----	87898-1721	87898-1731	-----	87898-1751	17	-----	1	43.18	40.64	10.81	9.65	5.84	1	
-----	-----	87898-1722	87898-1732	-----	87898-1752	17	-----	2	43.18	40.64	10.81	9.65	5.84	1	
-----	-----	87898-1724	87898-1734	-----	87898-1754	17	-----	4	43.18	40.64	10.81	9.65	5.84	1	
-----	-----	87898-1725	87898-1735	-----	87898-1755	17	-----	5	43.18	40.64	10.81	9.65	5.84	1	
-----	-----	87898-1726	87898-1736	-----	87898-1756	17	-----	6	43.18	40.64	10.81	9.65	5.84	1	
-----	-----	87898-1821	87898-1831	-----	87898-1851	18	-----	1	45.72	43.18	10.81	9.65	5.84	1	
-----	-----	87898-1822	87898-1832	-----	87898-1852	18	-----	2	45.72	43.18	10.81	9.65	5.84	1	
-----	-----	87898-1824	87898-1834	-----	87898-1854	18	-----	4	45.72	43.18	10.81	9.65	5.84	1	
-----	-----	87898-1825	87898-1835	-----	87898-1855	18	-----	5	45.72	43.18	10.81	9.65	5.84	1	
-----	-----	87898-1826	87898-1836	-----	87898-1856	18	-----	6	45.72	43.18	10.81	9.65	5.84	1	
-----	-----	87898-1827	87898-1837	-----	87898-1857	18	-----	6	45.72	43.18	10.81	9.65	5.84	1	

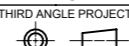
THIS DRAWING CONTAINS INFORMATION THAT IS PROPRIETARY TO MOLEX ELECTRONIC TECHNOLOGIES, LLC AND SHOULD NOT BE USED WITHOUT WRITTEN PERMISSION															
DIMENSION UNITS		SCALE		CURRENT REV DESC:											
mm		NTS													
GENERAL TOLERANCES (UNLESS SPECIFIED)				EC NO: 745488 DRWN: SUAIFR APPR: MRAMAKRISHNA INITIAL REVISION: DRWN: GGUNAGI APPR: ISHWARG				CUSTOM HEADER 2.54MM PITCH SINGLE ROW SINGLE WAFER SMT HEADER							
								PRODUCT CUSTOMER DRAWING							
								DOCUMENT NUMBER		DOC TYPE		DOC PART		REVISION	
								SD-87898-001		PSD		000		B26	
DRAFT WHERE APPLICABLE MUST REMAIN WITHIN DIMENSIONS				THIRD ANGLE PROJECTION		DRAWING		SERIES		MATERIAL NUMBER		CUSTOMER		SHEET NUMBER	
						A3-SIZE		87898		SEE TABLE		GENERAL MARKET		7 OF 21	

DOCUMENT STATUS	P1	RELEASE DATE	2023/04/10	07:46:21
-----------------	----	--------------	------------	----------

10		9		8		7		6		5		4		3		2		1					
PACKAGING OPTION PART NO.														CAP (SEE SHEET-16)									
TRAY WITHOUT CAP	TRAY WITH CAP	TUBE WITHOUT CAP	TUBE WITH CAP	TAPE & REEL WITHOUT CAP	TAPE & REEL WITH CAP	CKT SIZE	VOID POSITION	PLATING TYPE	DIMENSION														
									A	B	G	F	M										
-----	-----	87898-1921	87898-1931	-----	87898-1951	19	-----	1	48.26	45.72	10.81	9.65	5.84	1									
-----	-----	87898-1922	87898-1932	-----	87898-1952	19	-----	2	48.26	45.72	10.81	9.65	5.84	1									
-----	-----	87898-1924	87898-1934	-----	87898-1954	19	-----	4	48.26	45.72	10.81	9.65	5.84	1									
-----	-----	87898-1925	87898-1935	-----	87898-1955	19	-----	5	48.26	45.72	10.81	9.65	5.84	1									
-----	-----	87898-1926	87898-1936	-----	87898-1956	19	-----	6	48.26	45.72	10.81	9.65	5.84	1									
-----	-----	87898-2021	87898-2031	-----	87898-2051	20	-----	1	50.80	48.26	10.81	9.65	5.84	1									
-----	-----	87898-2022	87898-2032	-----	87898-2052	20	-----	2	50.80	48.26	10.81	9.65	5.84	1									
-----	-----	87898-2024	87898-2034	-----	87898-2054	20	-----	4	50.80	48.26	10.81	9.65	5.84	1									
-----	-----	87898-2025	87898-2035	-----	87898-2055	20	-----	5	50.80	48.26	10.81	9.65	5.84	1									
-----	-----	87898-2026	87898-2036	-----	87898-2056	20	-----	6	50.80	48.26	10.81	9.65	5.84	1									
-----	-----	87898-2027	87898-2037	-----	87898-2057	20	-----	6	50.80	48.26	10.81	9.65	5.84	1									
-----	-----	87898-2121	87898-2131	-----	87898-2151	21	-----	1	53.34	50.80	10.81	9.65	5.84	1									
-----	-----	87898-2122	87898-2132	-----	87898-2152	21	-----	2	53.34	50.80	10.81	9.65	5.84	1									
-----	-----	87898-2124	87898-2134	-----	87898-2154	21	-----	4	53.34	50.80	10.81	9.65	5.84	1									
-----	-----	87898-2125	87898-2135	-----	87898-2155	21	-----	5	53.34	50.80	10.81	9.65	5.84	1									
-----	-----	87898-2126	87898-2136	-----	87898-2156	21	-----	6	53.34	50.80	10.81	9.65	5.84	1									

THIS DRAWING CONTAINS INFORMATION THAT IS PROPRIETARY TO MOLEX ELECTRONIC TECHNOLOGIES, LLC AND SHOULD NOT BE USED WITHOUT WRITTEN PERMISSION

DIMENSION UNITS	SCALE	CURRENT REV DESC:		<b>molex</b>					
mm	NTS								
GENERAL TOLERANCES (UNLESS SPECIFIED)				CUSTOM HEADER 2.54MM PITCH SINGLE ROW SINGLE WAFER SMT HEADER					
	MM	INCH							
4 PLACES	±			EC NO: 745488		2023/02/15			
3 PLACES	±			DRWN: SUAIFR		2023/04/10			
2 PLACES	±	0.2		CHK'D: SUAIFR		2023/04/10			
1 PLACE	±			APPR: MRAMAKRISHNA		2023/04/10			
0 PLACES	±			INITIAL REVISION:					
ANGULAR TOL ± 3.0°				DRWN: GGUNAGI		2016/11/09			
DRAFT WHERE APPLICABLE MUST REMAIN WITHIN DIMENSIONS				APPR: ISHWARG		2016/12/06			
THIRD ANGLE PROJECTION		DRAWING	SERIES	MATERIAL NUMBER	CUSTOMER	DOC TYPE	DOC PART	REVISION	
		A3-SIZE	87898	SEE TABLE	GENERAL MARKET	PSD	000	B26	
DOCUMENT STATUS				RELEASE DATE		SHEET NUMBER			
P1				2023/04/10 07:46:21		8 OF 21			



PACKAGING OPTION PART NO.						CKT SIZE	VOID POSITION	PLATING TYPE	DIMENSION					CAP (SEE SHEET-16)
TRAY WITHOUT CAP	TRAY WITH CAP	TUBE WITHOUT CAP	TUBE WITH CAP	TAPE & REEL WITHOUT CAP	TAPE & REEL WITH CAP				A	B	G	F	M	
-----	-----	87898-2221	87898-2231	-----	-----	22	----	1	55.88	53.34	10.81	9.65	5.84	1
-----	-----	87898-2222	87898-2232	-----	-----	22	----	2	55.88	53.34	10.81	9.65	5.84	1
-----	-----	87898-2224	87898-2234	-----	-----	22	----	4	55.88	53.34	10.81	9.65	5.84	1
-----	-----	87898-2225	87898-2235	-----	-----	22	----	5	55.88	53.34	10.81	9.65	5.84	1
-----	-----	87898-2226	87898-2236	-----	-----	22	----	6	55.88	53.34	10.81	9.65	5.84	1
-----	-----	87898-2321	87898-2331	-----	-----	23	----	1	58.42	55.88	10.81	9.65	5.84	1
-----	-----	87898-2322	87898-2332	-----	-----	23	----	2	58.42	55.88	10.81	9.65	5.84	1
-----	-----	87898-2324	87898-2334	-----	-----	23	----	4	58.42	55.88	10.81	9.65	5.84	1
-----	-----	87898-2325	87898-2335	-----	-----	23	----	5	58.42	55.88	10.81	9.65	5.84	1
-----	-----	87898-2326	87898-2336	-----	-----	23	----	6	58.42	55.88	10.81	9.65	5.84	1
-----	-----	87898-2421	87898-2431	-----	-----	24	----	1	60.96	58.42	10.81	9.65	5.84	1
-----	-----	87898-2422	87898-2432	-----	-----	24	----	2	60.96	58.42	10.81	9.65	5.84	1
-----	-----	87898-2424	87898-2434	-----	-----	24	----	4	60.96	58.42	10.81	9.65	5.84	1
-----	-----	87898-2425	87898-2435	-----	-----	24	----	5	60.96	58.42	10.81	9.65	5.84	1
-----	-----	87898-2426	87898-2436	-----	-----	24	----	6	60.96	58.42	10.81	9.65	5.84	1
-----	-----	87898-2427	87898-2437	-----	-----	24	----	6	60.96	58.42	10.81	9.65	5.84	1

THIS DRAWING CONTAINS INFORMATION THAT IS PROPRIETARY TO MOLEX ELECTRONIC TECHNOLOGIES, LLC AND SHOULD NOT BE USED WITHOUT WRITTEN PERMISSION															
DIMENSION UNITS		SCALE		CURRENT REV DESC:											
mm		NTS		<p style="text-align: center;"><b>molex</b></p> <p style="text-align: center;">CUSTOM HEADER 2.54MM PITCH SINGLE ROW SINGLE WAFER SMT HEADER</p> <p style="text-align: center;">PRODUCT CUSTOMER DRAWING</p>											
GENERAL TOLERANCES (UNLESS SPECIFIED)															
		MM	INCH												
4 PLACES	±		±												
3 PLACES	±		±												
2 PLACES	±	0.2	±												
1 PLACE	±		±												
0 PLACES	±		±												
ANGULAR TOL ± 3.0°				<p>EC NO: 745488</p> <p>DRWN: SUAIFR 2023/02/15</p> <p>CHK'D: SUAIFR 2023/04/10</p> <p>APPR: MRAMAKRISHNA 2023/04/10</p> <p>INITIAL REVISION:</p> <p>DRWN: GGUNAGI 2016/11/09</p> <p>APPR: ISHWARG 2016/12/06</p>											
DRAFT WHERE APPLICABLE MUST REMAIN WITHIN DIMENSIONS				THIRD ANGLE PROJECTION		DRAWING		SERIES		MATERIAL NUMBER		CUSTOMER		SHEET NUMBER	
						A3-SIZE		87898		SEE TABLE		GENERAL MARKET		9 OF 21	

DOCUMENT STATUS	P1	RELEASE DATE	2023/04/10	07:46:21	9	8	7	6	5	4	3	2	1
-----------------	----	--------------	------------	----------	---	---	---	---	---	---	---	---	---

10		9		8		7		6		5		4		3		2		1	
PACKAGING OPTION PART NO.														CAP (SEE SHEET-16)					
TRAY WITHOUT CAP	TRAY WITH CAP	TUBE WITHOUT CAP	TUBE WITH CAP	TAPE & REEL WITHOUT CAP	TAPE & REEL WITH CAP	CKT SIZE	VOID POSITION	PLATING TYPE	DIMENSION										
										A	B	G	F	M					
-----	-----	87898-2521	87898-2531	-----	-----	25	----	1	63.50	60.96	10.81	9.65	5.84	1					
-----	-----	87898-2522	87898-2532	-----	-----	25	----	2	63.50	60.96	10.81	9.65	5.84	1					
-----	-----	87898-2524	87898-2534	-----	-----	25	----	4	63.50	60.96	10.81	9.65	5.84	1					
-----	-----	87898-2525	87898-2535	-----	-----	25	----	5	63.50	60.96	10.81	9.65	5.84	1					
-----	-----	87898-2526	87898-2536	-----	-----	25	----	6	63.50	60.96	10.81	9.65	5.84	1					
-----	-----	87898-2621	87898-2631	-----	-----	26	----	1	66.04	63.50	10.81	9.65	5.84	1					
-----	-----	87898-2622	87898-2632	-----	-----	26	----	2	66.04	63.50	10.81	9.65	5.84	1					
-----	-----	87898-2624	87898-2634	-----	-----	26	----	4	66.04	63.50	10.81	9.65	5.84	1					
-----	-----	87898-2625	87898-2635	-----	-----	26	----	5	66.04	63.50	10.81	9.65	5.84	1					
-----	-----	87898-2626	87898-2636	-----	-----	26	----	6	66.04	63.50	10.81	9.65	5.84	1					
-----	-----	87898-2627	87898-2637	-----	-----	26	----	6	66.04	63.50	10.81	9.65	5.84	1					
-----	-----	87898-2721	87898-2731	-----	-----	27	----	1	68.58	66.04	10.81	9.65	5.84	1					
-----	-----	87898-2722	87898-2732	-----	-----	27	----	2	68.58	66.04	10.81	9.65	5.84	1					
-----	-----	87898-2724	87898-2734	-----	-----	27	----	4	68.58	66.04	10.81	9.65	5.84	1					
-----	-----	87898-2725	87898-2735	-----	-----	27	----	5	68.58	66.04	10.81	9.65	5.84	1					
-----	-----	87898-2726	87898-2736	-----	-----	27	----	6	68.58	66.04	10.81	9.65	5.84	1					

THIS DRAWING CONTAINS INFORMATION THAT IS PROPRIETARY TO MOLEX ELECTRONIC TECHNOLOGIES, LLC AND SHOULD NOT BE USED WITHOUT WRITTEN PERMISSION																	
DIMENSION UNITS		SCALE		CURRENT REV DESC:													
mm		NTS		<p style="text-align: center;"><b>molex</b></p> <p style="text-align: center;">CUSTOM HEADER 2.54MM PITCH SINGLE ROW SINGLE WAFER SMT HEADER</p> <p style="text-align: center;">PRODUCT CUSTOMER DRAWING</p>													
GENERAL TOLERANCES (UNLESS SPECIFIED)																	
		MM	INCH														
4 PLACES	±		±														
3 PLACES	±		±														
2 PLACES	±	0.2	±														
1 PLACE	±		±														
0 PLACES	±		±														
ANGULAR TOL ± 3.0°				DRAFT WHERE APPLICABLE MUST REMAIN WITHIN DIMENSIONS		THIRD ANGLE PROJECTION		DRAWING		SERIES		MATERIAL NUMBER		CUSTOMER		SHEET NUMBER	
				A3-SIZE		87898		SEE TABLE		GENERAL MARKET		10 OF 21					

DOCUMENT STATUS P1 RELEASE DATE 2023/04/10 07:46:21

PACKAGING OPTION PART NO.						CKT SIZE	VOID POSITION	PLATING TYPE	DIMENSION					CAP (SEE SHEET-16)
TRAY WITHOUT CAP	TRAY WITH CAP	TUBE WITHOUT CAP	TUBE WITH CAP	TAPE & REEL WITHOUT CAP	TAPE & REEL WITH CAP				A	B	G	F	M	
-----	-----	87898-2821	87898-2831	-----	-----	28	----	1	71.12	68.58	10.81	9.65	5.84	1
-----	-----	87898-2822	87898-2832	-----	-----	28	----	2	71.12	68.58	10.81	9.65	5.84	1
-----	-----	87898-2824	87898-2834	-----	-----	28	----	4	71.12	68.58	10.81	9.65	5.84	1
-----	-----	87898-2825	87898-2835	-----	-----	28	----	5	71.12	68.58	10.81	9.65	5.84	1
-----	-----	87898-2826	87898-2836	-----	-----	28	----	6	71.12	68.58	10.81	9.65	5.84	1
-----	-----	87898-2921	87898-2931	-----	-----	29	----	1	73.66	71.12	10.81	9.65	5.84	1
-----	-----	87898-2922	87898-2932	-----	-----	29	----	2	73.66	71.12	10.81	9.65	5.84	1
-----	-----	87898-2924	87898-2934	-----	-----	29	----	4	73.66	71.12	10.81	9.65	5.84	1
-----	-----	87898-2925	87898-2935	-----	-----	29	----	5	73.66	71.12	10.81	9.65	5.84	1
-----	-----	87898-2926	87898-2936	-----	-----	29	----	6	73.66	71.12	10.81	9.65	5.84	1
-----	-----	87898-3021	87898-3031	-----	-----	30	----	1	76.20	73.66	10.81	9.65	5.84	1
-----	-----	87898-3022	87898-3032	-----	-----	30	----	2	76.20	73.66	10.81	9.65	5.84	1
-----	-----	87898-3024	87898-3034	-----	-----	30	----	4	76.20	73.66	10.81	9.65	5.84	1
-----	-----	87898-3025	87898-3035	-----	-----	30	----	5	76.20	73.66	10.81	9.65	5.84	1
-----	-----	87898-3026	87898-3036	-----	-----	30	----	6	76.20	73.66	10.81	9.65	5.84	1

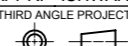

THIS DRAWING CONTAINS INFORMATION THAT IS PROPRIETARY TO MOLEX ELECTRONIC TECHNOLOGIES, LLC AND SHOULD NOT BE USED WITHOUT WRITTEN PERMISSION									
DIMENSION UNITS		SCALE		CURRENT REV DESC:					
mm		NTS							
GENERAL TOLERANCES (UNLESS SPECIFIED)				EC NO: 745488		2023/02/15		CUSTOM HEADER 2.54MM PITCH SINGLE ROW SINGLE WAFER SMT HEADER	
		MM		DRWN: SUAIFR		2023/04/10			
4 PLACES		±		CHK'D: SUAIFR		2023/04/10		PRODUCT CUSTOMER DRAWING	
3 PLACES		±		APPR: MRAMAKRISHNA		2023/04/10			
2 PLACES		± 0.2		INITIAL REVISION:				DOCUMENT NUMBER <b>SD-87898-001</b>	
1 PLACE		±		DRWN: GGUNAGI		2016/11/09			
0 PLACES		±		APPR: ISHWARG		2016/12/06		DOC PART 000	
ANGULAR TOL		± 3.0°							
DRAFT WHERE APPLICABLE MUST REMAIN WITHIN DIMENSIONS				THIRD ANGLE PROJECTION		DRAWING		SHEET NUMBER	
						A3-SIZE		11 OF 21	
SERIES		MATERIAL NUMBER		CUSTOMER					
87898		SEE TABLE		GENERAL MARKET					

DOCUMENT STATUS	P1	RELEASE DATE	2023/04/10	07:46:21
-----------------	----	--------------	------------	----------

10		9		8		7		6		5		4		3		2		1	
PACKAGING OPTION PART NO.						CKT SIZE	VOID POSITION	PLATING TYPE	DIMENSION					CAP (SEE SHEET-16)					
TRAY WITHOUT CAP	TRAY WITH CAP	TUBE WITHOUT CAP	TUBE WITH CAP	TAPE & REEL WITHOUT CAP	TAPE & REEL WITH CAP				A	B	G	F	M						
-----	-----	87898-3121	87898-3131	-----	-----	31	-----	1	78.74	76.20	10.81	9.65	5.84	1					
-----	-----	87898-3122	87898-3132	-----	-----	31	-----	2	78.74	76.20	10.81	9.65	5.84	1					
-----	-----	87898-3124	87898-3134	-----	-----	31	-----	4	78.74	76.20	10.81	9.65	5.84	1					
-----	-----	87898-3125	87898-3135	-----	-----	31	-----	5	78.74	76.20	10.81	9.65	5.84	1					
-----	-----	87898-3126	87898-3136	-----	-----	31	-----	6	78.74	76.20	10.81	9.65	5.84	1					
-----	-----	87898-3221	87898-3231	-----	-----	32	-----	1	81.28	78.74	10.81	9.65	5.84	1					
-----	-----	87898-3222	87898-3232	-----	-----	32	-----	2	81.28	78.74	10.81	9.65	5.84	1					
-----	-----	87898-3224	87898-3234	-----	-----	32	-----	4	81.28	78.74	10.81	9.65	5.84	1					
-----	-----	87898-3225	87898-3235	-----	-----	32	-----	5	81.28	78.74	10.81	9.65	5.84	1					
-----	-----	87898-3226	87898-3236	-----	-----	32	-----	6	81.28	78.74	10.81	9.65	5.84	1					
-----	-----	87898-3227	87898-3237	-----	-----	32	-----	6	81.28	78.74	10.81	9.65	5.84	1					
-----	-----	87898-3321	87898-3331	-----	-----	33	-----	1	83.82	81.28	10.81	9.65	5.84	1					
-----	-----	87898-3322	87898-3332	-----	-----	33	-----	2	83.82	81.28	10.81	9.65	5.84	1					
-----	-----	87898-3324	87898-3334	-----	-----	33	-----	4	83.82	81.28	10.81	9.65	5.84	1					
-----	-----	87898-3325	87898-3335	-----	-----	33	-----	5	83.82	81.28	10.81	9.65	5.84	1					
-----	-----	87898-3326	87898-3336	-----	-----	33	-----	6	83.82	81.28	10.81	9.65	5.84	1					

D																	
C																	
B																	
A																	

THIS DRAWING CONTAINS INFORMATION THAT IS PROPRIETARY TO MOLEX ELECTRONIC TECHNOLOGIES, LLC AND SHOULD NOT BE USED WITHOUT WRITTEN PERMISSION																					
DIMENSION UNITS		SCALE		CURRENT REV DESC:																	
mm		NTS		<p style="text-align: center;"><b>molex</b></p> <p style="text-align: center;">CUSTOM HEADER 2.54MM PITCH SINGLE ROW SINGLE WAFER SMT HEADER</p> <p style="text-align: center;">PRODUCT CUSTOMER DRAWING</p>																	
GENERAL TOLERANCES (UNLESS SPECIFIED)																					
		MM																INCH			
4 PLACES	±		±																		
3 PLACES	±		±																		
2 PLACES	±	0.2	±																		
1 PLACE	±		±																		
0 PLACES	±		±																		
ANGULAR TOL ± 3.0°				<p>EC NO: 745488</p> <p>DRWN: SUAIFR 2023/02/15</p> <p>CHK'D: SUAIFR 2023/04/10</p> <p>APPR: MRAMAKRISHNA 2023/04/10</p> <p>INITIAL REVISION:</p> <p>DRWN: GGUNAGI 2016/11/09</p> <p>APPR: ISHWARG 2016/12/06</p>																	
DRAFT WHERE APPLICABLE MUST REMAIN WITHIN DIMENSIONS				THIRD ANGLE PROJECTION		DRAWING		SERIES		MATERIAL NUMBER		CUSTOMER		DOCUMENT NUMBER		DOC TYPE		DOC PART		REVISION	
						A3-SIZE		87898		SEE TABLE		GENERAL MARKET		SD-87898-001		PSD		000		B26	
DOCUMENT STATUS				P1		RELEASE DATE		2023/04/10		07:46:21											

PACKAGING OPTION PART NO.						CKT SIZE	VOID POSITION	PLATING TYPE	DIMENSION					CAP (SEE SHEET-16)
TRAY WITHOUT CAP	TRAY WITH CAP	TUBE WITHOUT CAP	TUBE WITH CAP	TAPE & REEL WITHOUT CAP	TAPE & REEL WITH CAP				A	B	G	F	M	
-----	-----	87898-3421	87898-3431	-----	-----	34	----	1	86.36	83.82	10.81	9.65	5.84	1
-----	-----	87898-3422	87898-3432	-----	-----	34	----	2	86.36	83.82	10.81	9.65	5.84	1
-----	-----	87898-3424	87898-3434	-----	-----	34	----	4	86.36	83.82	10.81	9.65	5.84	1
-----	-----	87898-3425	87898-3435	-----	-----	34	----	5	86.36	83.82	10.81	9.65	5.84	1
-----	-----	87898-3426	87898-3436	-----	-----	34	----	6	86.36	83.82	10.81	9.65	5.84	1
-----	-----	87898-3521	87898-3531	-----	-----	35	----	1	88.90	86.36	10.81	9.65	5.84	1
-----	-----	87898-3522	87898-3532	-----	-----	35	----	2	88.90	86.36	10.81	9.65	5.84	1
-----	-----	87898-3524	87898-3534	-----	-----	35	----	4	88.90	86.36	10.81	9.65	5.84	1
-----	-----	87898-3525	87898-3535	-----	-----	35	----	5	88.90	86.36	10.81	9.65	5.84	1
-----	-----	87898-3526	87898-3536	-----	-----	35	----	6	88.90	86.36	10.81	9.65	5.84	1
-----	-----	87898-3621	87898-3631	-----	-----	36	----	1	91.44	88.90	10.81	9.65	5.84	1
-----	-----	87898-3622	87898-3632	-----	-----	36	----	2	91.44	88.90	10.81	9.65	5.84	1
-----	-----	87898-3624	87898-3634	-----	-----	36	----	4	91.44	88.90	10.81	9.65	5.84	1
-----	-----	87898-3625	87898-3635	-----	-----	36	----	5	91.44	88.90	10.81	9.65	5.84	1
-----	-----	87898-3626	87898-3636	-----	-----	36	----	6	91.44	88.90	10.81	9.65	5.84	1

THIS DRAWING CONTAINS INFORMATION THAT IS PROPRIETARY TO MOLEX ELECTRONIC TECHNOLOGIES, LLC AND SHOULD NOT BE USED WITHOUT WRITTEN PERMISSION

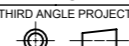
DIMENSION UNITS	SCALE	CURRENT REV DESC:	 <b>molex</b> CUSTOM HEADER 2.54MM PITCH SINGLE ROW SINGLE WAFER SMT HEADER PRODUCT CUSTOMER DRAWING			
mm	NTS	EC NO: 745488				
GENERAL TOLERANCES (UNLESS SPECIFIED)		DRWN: SUAIFR 2023/02/15				
	MM INCH	CHK'D: SUAIFR 2023/04/10				
4 PLACES	±	APPR: MRAMAKRISHNA 2023/04/10				
3 PLACES	±	INITIAL REVISION:				
2 PLACES	± 0.2	DRWN: GGUNAGI 2016/11/09				
1 PLACE	±	APPR: ISHWARG 2016/12/06				
0 PLACES	±					
ANGULAR TOL	± 3.0°					
DRAFT WHERE APPLICABLE MUST REMAIN WITHIN DIMENSIONS	THIRD ANGLE PROJECTION	DRAWING	SERIES	MATERIAL NUMBER	CUSTOMER	SHEET NUMBER
		A3-SIZE	87898	SEE TABLE	GENERAL MARKET	13 OF 21

DOCUMENT STATUS	P1	RELEASE DATE	2023/04/10	07:46:21
-----------------	----	--------------	------------	----------

PACKAGING OPTION PART NO.						CKT SIZE	VOID POSITION	PLATING TYPE	DIMENSION					CAP (SEE SHEET-16)
TRAY WITHOUT CAP	TRAY WITH CAP	TUBE WITHOUT CAP	TUBE WITH CAP	TAPE & REEL WITHOUT CAP	TAPE & REEL WITH CAP				A	B	G	F	M	
-----	-----	87898-3721	87898-3731	-----	-----	37	-----	1	93.98	91.44	10.81	9.65	5.84	1
-----	-----	87898-3722	87898-3732	-----	-----	37	-----	2	93.98	91.44	10.81	9.65	5.84	1
-----	-----	87898-3724	87898-3734	-----	-----	37	-----	4	93.98	91.44	10.81	9.65	5.84	1
-----	-----	87898-3725	87898-3735	-----	-----	37	-----	5	93.98	91.44	10.81	9.65	5.84	1
-----	-----	87898-3726	87898-3736	-----	-----	37	-----	6	93.98	91.44	10.81	9.65	5.84	1
-----	-----	87898-3821	87898-3831	-----	-----	38	-----	1	96.52	93.98	10.81	9.65	5.84	1
-----	-----	87898-3822	87898-3832	-----	-----	38	-----	2	96.52	93.98	10.81	9.65	5.84	1
-----	-----	87898-3824	87898-3834	-----	-----	38	-----	4	96.52	93.98	10.81	9.65	5.84	1
-----	-----	87898-3825	87898-3835	-----	-----	38	-----	5	96.52	93.98	10.81	9.65	5.84	1
-----	-----	87898-3826	87898-3836	-----	-----	38	-----	6	96.52	93.98	10.81	9.65	5.84	1
-----	-----	87898-3921	87898-3931	-----	-----	39	-----	1	99.06	96.52	10.81	9.65	5.84	1
-----	-----	87898-3922	87898-3932	-----	-----	39	-----	2	99.06	96.52	10.81	9.65	5.84	1
-----	-----	87898-3924	87898-3934	-----	-----	39	-----	4	99.06	96.52	10.81	9.65	5.84	1
-----	-----	87898-3925	87898-3935	-----	-----	39	-----	5	99.06	96.52	10.81	9.65	5.84	1
-----	-----	87898-3926	87898-3936	-----	-----	39	-----	6	99.06	96.52	10.81	9.65	5.84	1



THIS DRAWING CONTAINS INFORMATION THAT IS PROPRIETARY TO MOLEX ELECTRONIC TECHNOLOGIES, LLC AND SHOULD NOT BE USED WITHOUT WRITTEN PERMISSION													
DIMENSION UNITS <b>mm</b>		SCALE <b>NTS</b>		CURRENT REV DESC:				 <b>CUSTOM HEADER</b> 2.54MM PITCH SINGLE ROW SINGLE WAFER SMT HEADER					
GENERAL TOLERANCES (UNLESS SPECIFIED)				EC NO: 745488									
				DRWN: SUAIFR 2023/02/15				<b>PRODUCT CUSTOMER DRAWING</b> DOCUMENT NUMBER: <b>SD-87898-001</b> DOC TYPE: PSD DOC PART: 000 REVISION: B26					
				CHK'D: SUAIFR 2023/04/10									
				APPR: MRAMAKRISHNA 2023/04/10				INITIAL REVISION: DRWN: GGUNAGI 2016/11/09 APPR: ISHWARG 2016/12/06					
				ANGULAR TOL ± 3.0°									
DRAFT WHERE APPLICABLE MUST REMAIN WITHIN DIMENSIONS		THIRD ANGLE PROJECTION		DRAWING		SERIES		MATERIAL NUMBER		CUSTOMER		SHEET NUMBER	
				<b>A3-SIZE</b>		<b>87898</b>		SEE TABLE		GENERAL MARKET		14 OF 21	
DOCUMENT STATUS	P1	RELEASE DATE	2023/04/10	07:46:21									

10	9	8	7	6	5	4	3	2	1					
PACKAGING OPTION PART NO.						CKT SIZE	VOID POSITION	PLATING TYPE	DIMENSION					CAP (SEE SHEET-16)
TRAY WITHOUT CAP	TRAY WITH CAP	TUBE WITHOUT CAP	TUBE WITH CAP	TAPE & REEL WITHOUT CAP	TAPE & REEL WITH CAP				A	B	G	F	M	
-----	-----	87898-4021	87898-4031	-----	-----	40	-----	1	101.60	99.06	10.81	9.65	5.84	1
-----	-----	87898-4022	87898-4032	-----	-----	40	-----	2	101.60	99.06	10.81	9.65	5.84	1
-----	-----	87898-4024	87898-4034	-----	-----	40	-----	4	101.60	99.06	10.81	9.65	5.84	1
-----	-----	87898-4025	87898-4035	-----	-----	40	-----	5	101.60	99.06	10.81	9.65	5.84	1
-----	-----	87898-4026	87898-4036	-----	-----	40	-----	6	101.60	99.06	10.81	9.65	5.84	1

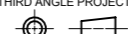

THIS DRAWING CONTAINS INFORMATION THAT IS PROPRIETARY TO MOLEX ELECTRONIC TECHNOLOGIES, LLC AND SHOULD NOT BE USED WITHOUT WRITTEN PERMISSION									
DIMENSION UNITS		SCALE		CURRENT REV DESC:					
mm		NTS							
GENERAL TOLERANCES (UNLESS SPECIFIED)				EC NO: 745488		2023/02/15		CUSTOMER DRAWING	
				DRWN: SUAIFR		2023/04/10			
				CHK'D: SUAIFR		2023/04/10		SD-87898-001	
				APPR: MRAMAKRISHNA		2023/04/10			
				INITIAL REVISION:				PSD 000 B26	
				DRWN: GGUNAGI		2016/11/09			
				APPR: ISHWARG		2016/12/06		SEE TABLE	
				ANGULAR TOL ± 3.0°					
DRAFT WHERE APPLICABLE MUST REMAIN WITHIN DIMENSIONS				THIRD ANGLE PROJECTION		DRAWING		SHEET NUMBER	
						A3-SIZE		15 OF 21	
						SERIES		CUSTOMER	
						87898		GENERAL MARKET	

DOCUMENT STATUS	P1	RELEASE DATE	2023/04/10	07:46:21
-----------------	----	--------------	------------	----------

# CAP ORIENTATION (CAP - 1)

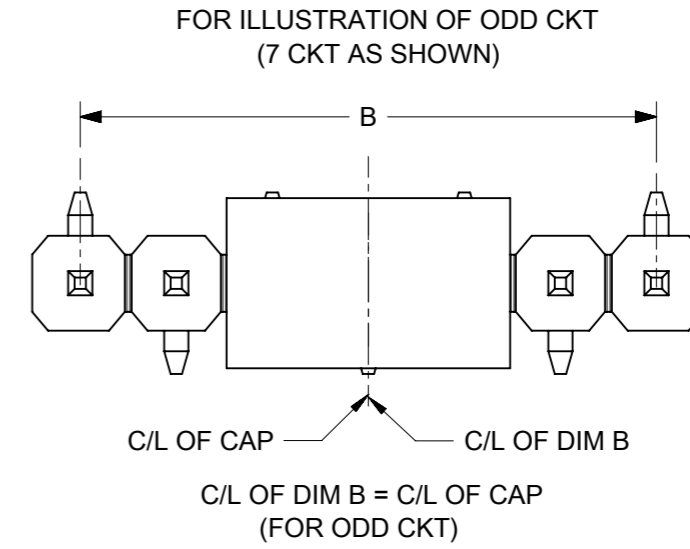
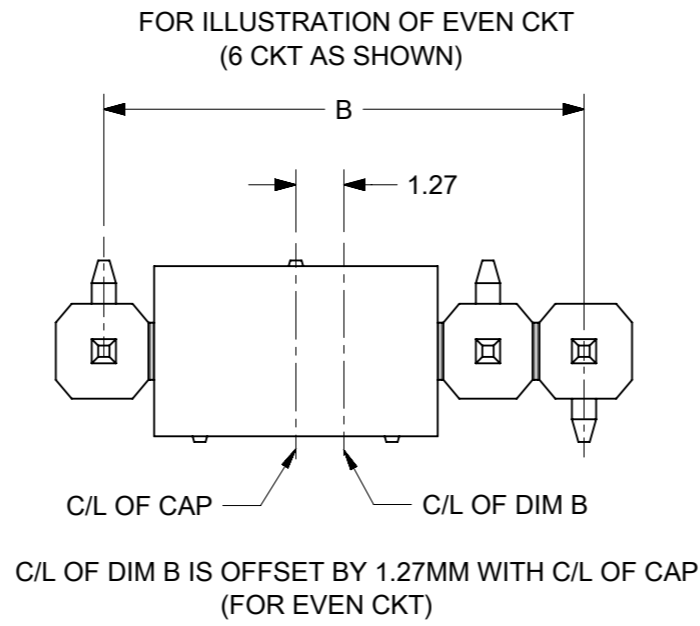

# CAP ORIENTATION (CAP - 2)

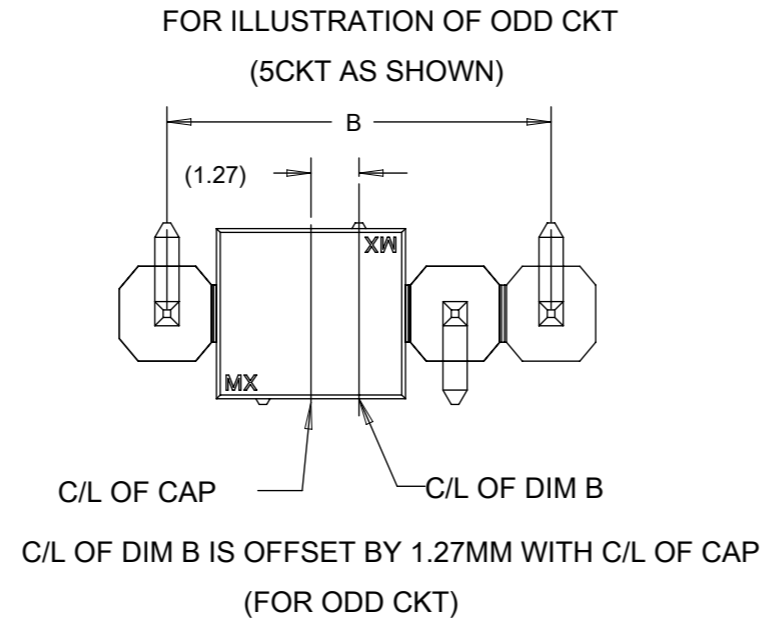

# PART ORIENTATION IN TUBE



PART WITHOUT CAP

PART WITH CAP

THIS DRAWING CONTAINS INFORMATION THAT IS PROPRIETARY TO MOLEX ELECTRONIC TECHNOLOGIES, LLC AND SHOULD NOT BE USED WITHOUT WRITTEN PERMISSION																	
DIMENSION UNITS		SCALE		CURRENT REV DESC:						<b>molex</b>							
mm		NTS		EC NO: 745488 DRWN: SUAIFR CHK'D: SUAIFR APPR: MRAMAKRISHNA INITIAL REVISION: DRWN: GGUNAGI APPR: ISHWARG ANGULAR TOL ± 3.0°								CUSTOMER					
GENERAL TOLERANCES (UNLESS SPECIFIED)										2023/02/15		2023/04/10		2023/04/10		CUSTOMER	
										2023/04/10		2023/04/10		CUSTOMER		CUSTOMER	
4 PLACES ±		±								2023/04/10		2023/04/10		CUSTOMER		CUSTOMER	
3 PLACES ±		±								2023/04/10		2023/04/10		CUSTOMER		CUSTOMER	
2 PLACES ±		0.2 ±		2023/04/10		2023/04/10		CUSTOMER		CUSTOMER							
1 PLACE ±		±		2023/04/10		2023/04/10		CUSTOMER		CUSTOMER							
0 PLACES ±		±		2023/04/10		2023/04/10		CUSTOMER		CUSTOMER							
DRAFT WHERE APPLICABLE MUST REMAIN WITHIN DIMENSIONS				THIRD ANGLE PROJECTION		DRAWING		SERIES		MATERIAL NUMBER							
						A3-SIZE		87898		SEE TABLE							
										CUSTOMER							
										GENERAL MARKET							
										SHEET NUMBER							
										16 OF 21							



EMBOSED CARRIER TYPE 'A'

CKT	DIMENSION				
	Bo	Ao	Ko	F	W
2	8.02	5.20	13.60	11.50	24.00
3	8.02	5.20	13.60	11.50	24.00
4	10.55	5.20	13.60	11.50	24.00

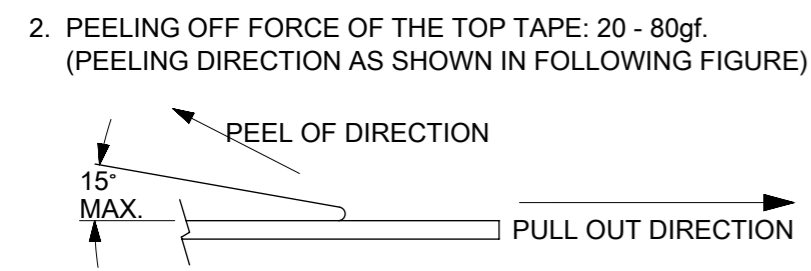
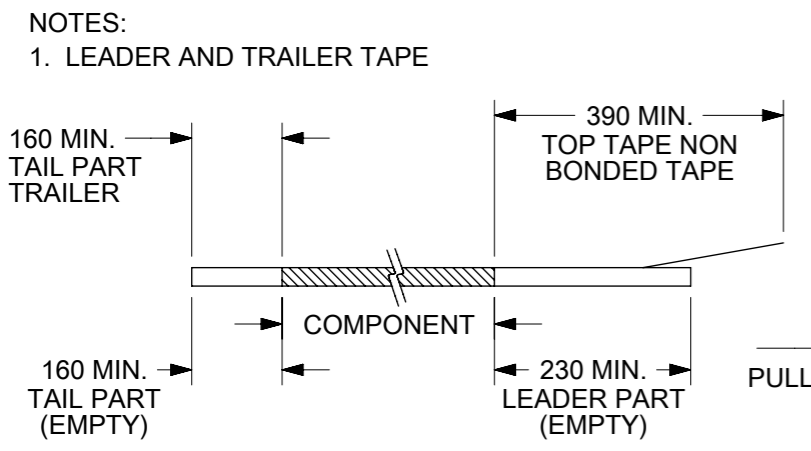
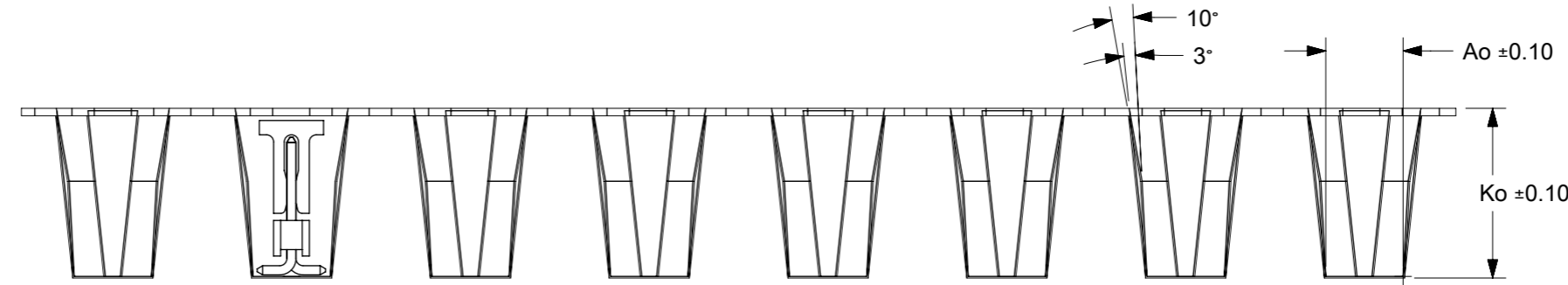
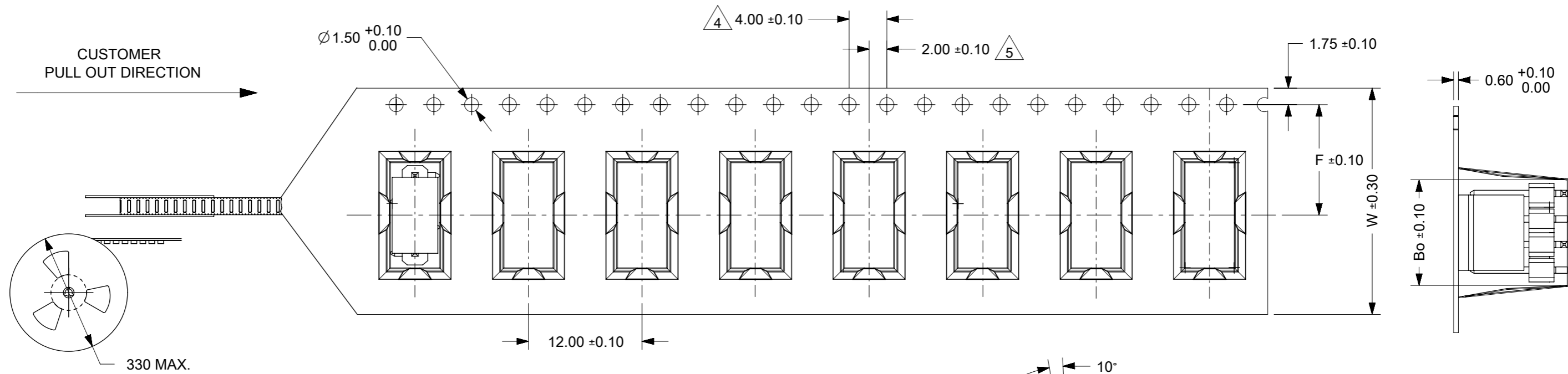

- LEADER AND TRAILER TAPE
- PEELING OFF FORCE OF THE TOP TAPE: 20 - 80gf. (PEELING DIRECTION AS SHOWN IN FOLLOWING FIGURE)
- MATERIAL: BLACK P.S CONDUCTIVE, BLACK
- MEASURED FROM CENTRELINE OF SPROCKET HOLE TO CENTRELINE OF SPOCKET
- CUMULATIVE TOLERANCE OF 10 SPROCKET HOLE IS  $\pm 0.20\text{mm}$
- A0 AND B0 ARE MEASURE FROM ABOVE POCKET BASE  $0.30\text{mm}$
- TAPE AND REEL SPECIFICATION IS AS PER EIA-481.
- TAPE AND REEL QUANTITY : 440PCS/REEL
- THE TAPE IS TREATED FOR ANTI-STATIC.
- ALL RADIUS ARE  $0.30\text{MM}$  UNLESS SPECIFY
- SURFACE RESISTIVITY  $10^3$  TO  $10^6$  OHMS.

PART PACK IN E/TAPE ORIENTATION (FOR REF USE)

THIS DRAWING CONTAINS INFORMATION THAT IS PROPRIETARY TO MOLEX ELECTRONIC TECHNOLOGIES, LLC AND SHOULD NOT BE USED WITHOUT WRITTEN PERMISSION

DIMENSION UNITS	SCALE	CURRENT REV DESC:	
mm	NTS		
GENERAL TOLERANCES (UNLESS SPECIFIED)			
	MM	INCH	
4 PLACES	$\pm$	$\pm$	
3 PLACES	$\pm$	$\pm$	
2 PLACES	$\pm 0.2$	$\pm$	
1 PLACE	$\pm$	$\pm$	
0 PLACES	$\pm$	$\pm$	
ANGULAR TOL	$\pm 3.0^\circ$		
DRAFT WHERE APPLICABLE MUST REMAIN WITHIN DIMENSIONS		THIRD ANGLE PROJECTION	DRAWING
			A3-SIZE
		SERIES	87898
		MATERIAL NUMBER	SEE TABLE
		CUSTOMER	GENERAL MARKET
		SHEET NUMBER	17 OF 21

EC NO: 745488  
 DRWN: SUAIFR 2023/02/15  
 CHK'D: SUAIFR 2023/04/10  
 APPR: MRAMAKRISHNA 2023/04/10

INITIAL REVISION:  
 DRWN: GGUNAGI 2016/11/09  
 APPR: ISHWARG 2016/12/06

DOCUMENT NUMBER: SD-87898-001  
 DOC TYPE: PSD  
 DOC PART: 000  
 REVISION: B26

**molex**  
 CUSTOM HEADER  
 2.54MM PITCH SINGLE ROW SINGLE WAFER SMT HEADER

PRODUCT CUSTOMER DRAWING

CKT	DIMENSION				
	Bo	Ao	Ko	F	W
5	13.10	5.20	11.30	11.50	24.00



330 MAX.

NOTES:  
1. LEADER AND TRAILER TAPE

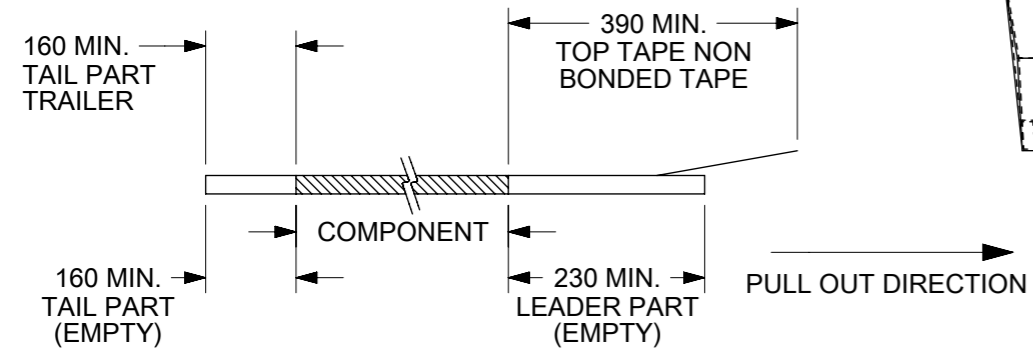

PART PACK  
IN E/TAPE  
ORIENTATION  
(FOR REF USE)

2. PEELING OFF FORCE OF THE TOP TAPE: 20 - 80gf.  
(PEELING DIRECTION AS SHOWN IN FOLLOWING FIGURE)

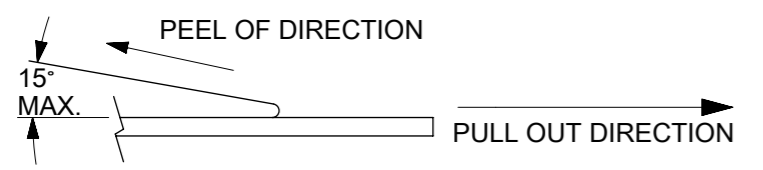

- 3. MATERIAL: BLACK P.S CONDUCTIVE, BLACK
- 4. MEASURED FROM CENTRELINE OF SPROCKET HOLE TO CENTRELINE OF SPOCKET
- 5. CUMULATIVE TOLERANCE OF 10 SPROCKET HOLE IS ±0.20mm
- 6. A0 AND B0 ARE MEASURE FROM ABOVE POCKET BASE 0.30mm
- 7. TAPE AND REEL SPECIFICATION IS AS PER EIA-481.
- 8. TAPE AND REEL QUANTITY : 440PCS/REEL
- 9. THE TAPE IS TREATED FOR ANTI-STATIC.
- 10. ALL RADIUS ARE 0.30MM UNLESS SPECIFY
- 11. SURFACE RESISTIVITY 10<sup>3</sup> TO 10 OHMS.

THIS DRAWING CONTAINS INFORMATION THAT IS PROPRIETARY TO MOLEX ELECTRONIC TECHNOLOGIES, LLC AND SHOULD NOT BE USED WITHOUT WRITTEN PERMISSION		CURRENT REV DESC:		<b>molex</b>	
DIMENSION UNITS	SCALE	EC NO: 745488			
mm	NTS	DRWN: SUAIFR 2023/02/15		CUSTOMER	
GENERAL TOLERANCES (UNLESS SPECIFIED)		CHK'D: SUAIFR 2023/04/10		2.54MM PITCH SINGLE ROW SINGLE WAFER SMT HEADER	
		APPR: MRAMAKRISHNA 2023/04/10		PRODUCT CUSTOMER DRAWING	
		INITIAL REVISION:		DOCUMENT NUMBER	
		DRWN: GGUNAGI 2016/11/09		SD-87898-001	
		APPR: ISHWARG 2016/12/06		DOC TYPE	
		ANGULAR TOL ± 3.0°		PSD	
DRAFT WHERE APPLICABLE MUST REMAIN WITHIN DIMENSIONS		THIRD ANGLE PROJECTION		DOC PART	
		DRAWING		000	
		SERIES		REVISION	
		A3-SIZE		B26	
		MATERIAL NUMBER		SHEET NUMBER	
		87898		18 OF 21	
		CUSTOMER			
		GENERAL MARKET			

10  
9  
8  
7  
6  
5  
4  
3  
2  
1



CKT	DIMENSION							TYPE	QTY/ REEL
	M	Bo	So	Ao	Ko	F	W		
6	11.50	15.65	28.40	5.20	16.90	14.20	32.00	A	150
6	5.84	15.65	28.40	5.20	11.30	14.20	32.00	B	440
8		20.70	40.40	5.20	11.30	20.20	44.00		
10		25.80	40.40	5.20	11.30	20.20	44.00		
12		30.90	52.40	5.20	11.30	26.20	56.00		
14		35.95	52.40	5.20	11.30	26.20	56.00		
16		41.05	52.40	5.20	11.30	26.20	56.00		
18		46.20	68.40	5.20	11.30	34.20	72.00		
20		51.20	68.40	5.20	11.30	34.20	72.00		

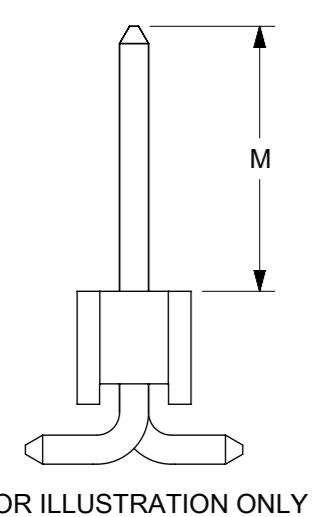

NOTES:  
1. LEADER AND TRAILER TAPE

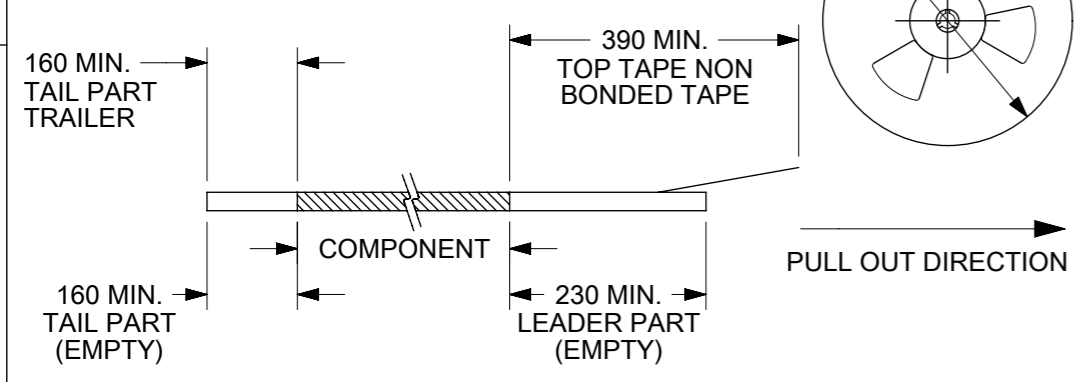

2. PEELING OFF FORCE OF THE TOP TAPE: 20 - 80gf.  
(PEELING DIRECTION AS SHOWN IN FOLLOWING FIGURE)



- 3. MATERIAL: BLACK P.S CONDUCTIVE, BLACK
- 4. MEASURED FROM CENTRELINE OF SPROCKET HOLE TO CENTRELINE OF SPOCKET
- 5. CUMULATIVE TOLERANCE OF 10 SPROCKET HOLE IS ±0.20mm
- 6. A0 AND B0 ARE MEASURE FROM ABOVE POCKET BASE 0.30mm
- 7. TAPE AND REEL SPECIFICATION IS AS PER EIA-481.
- 8. TAPE AND REEL QUANTITY : SEE TABLE
- 9. THE TAPE IS TREATED FOR ANTI-STATIC.
- 10. ALL RADIUS ARE 0.30MM UNLESS SPECIFY
- 11. SURFACE RESISTIVITY 10<sup>3</sup> TO 10 OHMS.

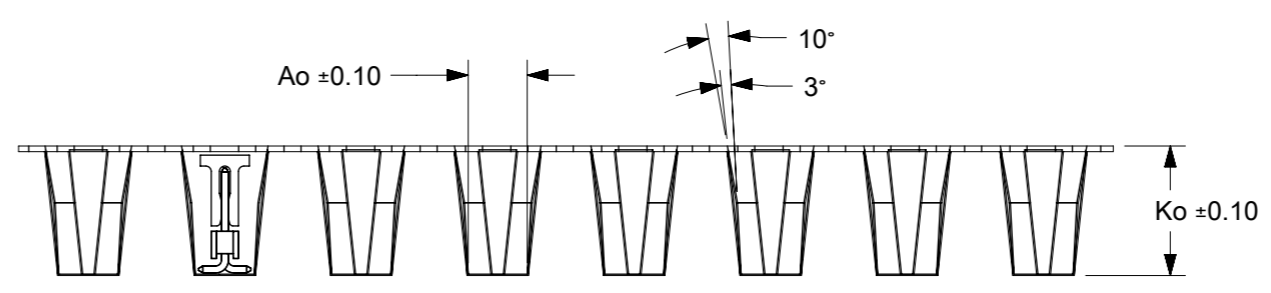

THIS DRAWING CONTAINS INFORMATION THAT IS PROPRIETARY TO MOLEX ELECTRONIC TECHNOLOGIES, LLC AND SHOULD NOT BE USED WITHOUT WRITTEN PERMISSION

DIMENSION UNITS	SCALE	CURRENT REV DESC:	
mm	NTS		
GENERAL TOLERANCES (UNLESS SPECIFIED)			
	MM	INCH	
4 PLACES	±	±	
3 PLACES	±	±	
2 PLACES	±	0.2	±
1 PLACE	±	±	
0 PLACES	±	±	
ANGULAR TOL	±	3.0°	
DRAFT WHERE APPLICABLE MUST REMAIN WITHIN DIMENSIONS		THIRD ANGLE PROJECTION	DRAWING
			A3-SIZE
		SERIES	87898
		MATERIAL NUMBER	SEE TABLE
		CUSTOMER	GENERAL MARKET
		SHEET NUMBER	19 OF 21

EC NO: 745488  
DRWN: SUAIFR 2023/02/15  
CHK'D: SUAIFR 2023/04/10  
APPR: MRAMAKRISHNA 2023/04/10

INITIAL REVISION:  
DRWN: GGUNAGI 2016/11/09  
APPR: ISHWARG 2016/12/06

**molex**  
CUSTOM HEADER  
2.54MM PITCH SINGLE ROW SINGLE WAFER SMT HEADER

PRODUCT CUSTOMER DRAWING

DOCUMENT NUMBER: SD-87898-001  
DOC TYPE: PSD  
DOC PART: 000  
REVISION: B26

9  
8  
7  
6  
5  
4  
3  
2  
1

10 9 8 7 6 5 4 3 2 1

F

E

D

C

B

A

F

E

D

C

B

A

CUSTOMER PULL OUT DIRECTION

330 MAX.

$\varnothing 1.50^{+0.10}_0$

4  $4.00 \pm 0.10$

5  $2.00 \pm 0.10$

$1.75 \pm 0.10$

$0.60^{+0.10}_{0.00}$

$F \pm 0.10$

$So \pm 0.10$

$W \pm 0.30$

$Bo \pm 0.10$

$12.00 \pm 0.10$

$Ao \pm 0.10$

R0.75

OF

$0.20 \pm 0.05$

$Ko \pm 0.10$

NOTES:  
1. LEADER AND TRAILER TAPE

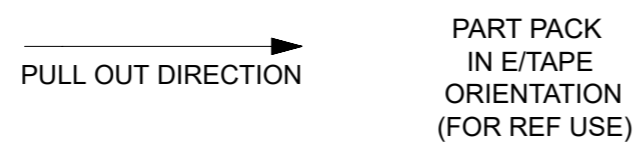
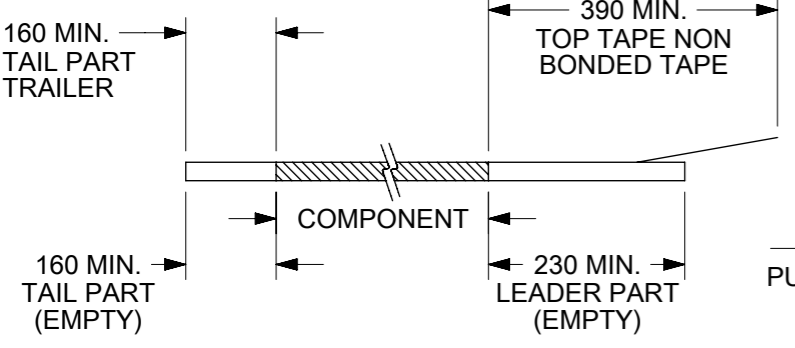

2. PEELING OFF FORCE OF THE TOP TAPE: 20 - 80gf.  
(PEELING DIRECTION AS SHOWN IN FOLLOWING FIGURE)

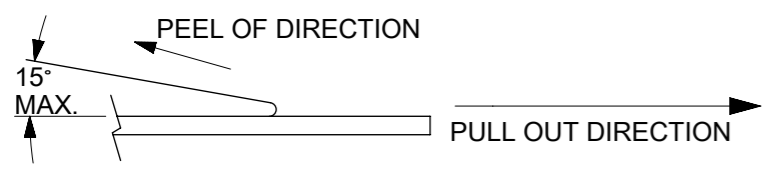

3. MATERIAL: BLACK P.S CONDUCTIVE, BLACK

4 MEASURED FROM CENTRELINE OF SPROCKET HOLE TO CENTRELINE OF SPOCKET

5 CUMULATIVE TOLERANCE OF 10 SPROCKET HOLE IS  $\pm 0.20$ mm

6. A0 AND B0 ARE MEASURE FROM ABOVE POCKET BASE 0.30mm

7. TAPE AND REEL SPECIFICATION IS AS PER EIA-481.

8. TAPE AND REEL QUANTITY : 440PCS/REEL

9. THE TAPE IS TREATED FOR ANTI-STATIC.

10. ALL RADIUS ARE 0.30MM UNLESS SPECIFY

11. SURFACE RESISTIVITY  $10^3$  TO  $10$  OHMS.

CKT	DIMENSION					
	Bo	So	Ao	Ko	F	W
7	18.20	40.40	5.20	11.30	20.20	44.00
9	23.25	40.40	5.20	11.30	20.20	44.00
11	28.35	40.40	5.20	11.30	20.20	44.00
13	33.40	52.40	5.20	11.30	26.20	56.00
15	38.50	52.40	5.20	11.30	26.20	56.00
17	43.60	68.40	5.20	11.30	34.20	72.00
19	48.70	68.40	5.20	11.30	34.20	72.00
21	53.80	68.40	5.20	11.30	34.20	72.00

THIS DRAWING CONTAINS INFORMATION THAT IS PROPRIETARY TO MOLEX ELECTRONIC TECHNOLOGIES, LLC AND SHOULD NOT BE USED WITHOUT WRITTEN PERMISSION

DIMENSION UNITS	SCALE	CURRENT REV DESC:	<b>molex</b>			
mm	NTS					
GENERAL TOLERANCES (UNLESS SPECIFIED)			CUSTOM HEADER 2.54MM PITCH SINGLE ROW SINGLE WAFER SMT HEADER			
	MM	INCH	PRODUCT CUSTOMER DRAWING			
4 PLACES	±	±	DOCUMENT NUMBER			
3 PLACES	±	±	DOC TYPE			
2 PLACES	± 0.2	±	DOC PART			
1 PLACE	±	±	REVISION			
0 PLACES	±	±	SD-87898-001		PSD 000 B26	
ANGULAR TOL	± 3.0°		MATERIAL NUMBER		CUSTOMER	
DRAFT WHERE APPLICABLE MUST REMAIN WITHIN DIMENSIONS			SEE TABLE		GENERAL MARKET	
THIRD ANGLE PROJECTION			DRAWING		SHEET NUMBER	
			A3-SIZE		20 OF 21	
			SERIES			
			87898			

DOCUMENT STATUS	P1	RELEASE DATE	2023/04/10	07:46:21
-----------------	----	--------------	------------	----------

9 8 7 6 5 4 3 2 1

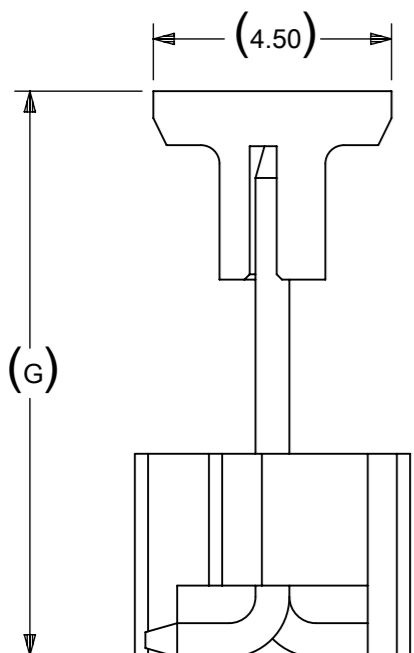
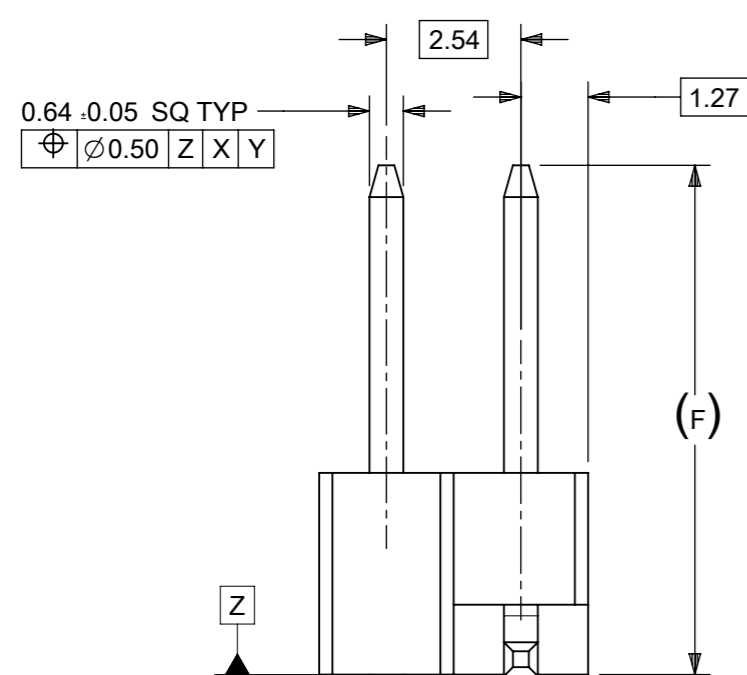
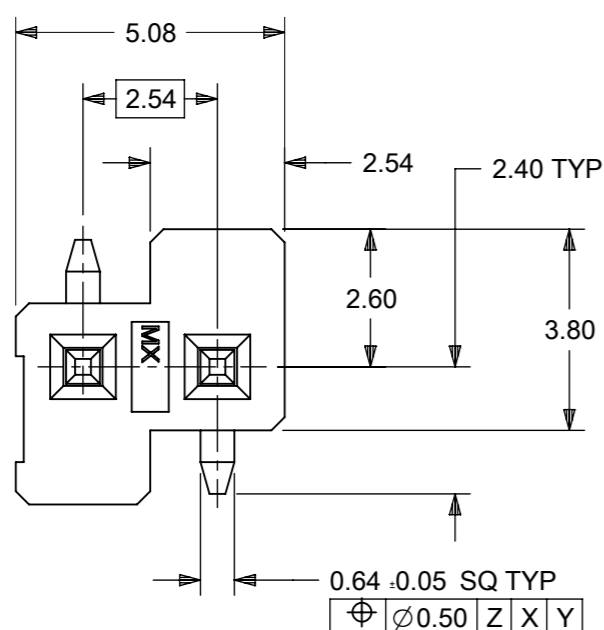

CONN WITH CAP

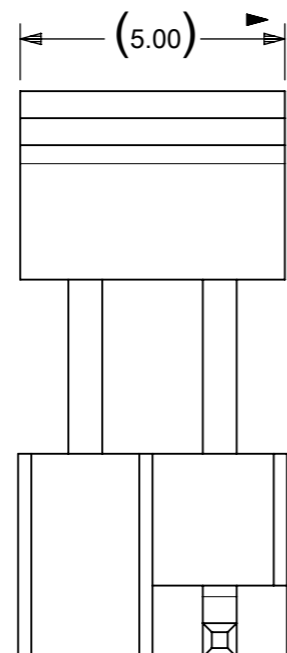

CONN WITH CAP

PACKAGING OPTION PART NO.						CKT SIZE	PLATING TYPE	DIMENSION			CAP (SEE SHEET-16)
TRAY WITHOUT CAP	TRAY WITH CAP	TUBE WITHOUT CAP	TUBE WITH CAP	TAPE & REEL WITHOUT CAP	TAPE & REEL WITH CAP			G	F	M	
-----	-----	-----	-----	-----	87898-0218	2	4	10.69	9.65	5.84	2
-----	-----	-----	-----	-----	87898-0219	2	6	10.69	9.65	5.84	2
-----	-----	-----	87898-0220	-----	-----	2	6	10.64	9.60	5.84	-
-----	-----	-----	-----	-----	87898-0221	2	6	24.53	23.49	19.73	-

ONLY APPLICABLE TO 2CKT SIZE

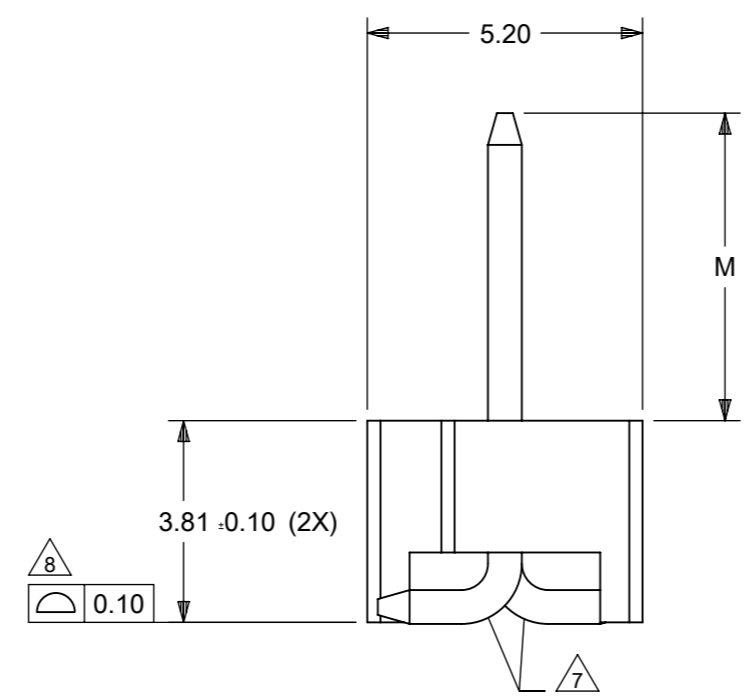

NOTES:

- MATERIAL:  
HSG: LCP, GLASS-FILLED, UL94V-0, COLOR: BLACK  
CAP: NYLON, GLASS-FILLED, UL94V-0, COLOR: BLACK  
PIN: 0.64MM SQ, COPPER ALLOY
- PLATING TYPE:  
(1) GOLD FLASH OVER  
1.25µm MIN. NICKEL OVERALL.  
(2) GOLD FLASH ON CONTACT AND  
2.50µm MIN. TIN ON SOLDER TAIL OVER  
1.25µm MIN. NICKEL OVERALL.  
(4) 0.38µm MIN. GOLD PLATE ON CONTACT AND  
2.00µm MIN. TIN ON SOLDER TAIL OVER  
1.25µm MIN. NICKEL OVERALL.  
(5) 0.75µm MIN. GOLD PLATE ON CONTACT AND  
2.00µm MIN. TIN ON SOLDER TAIL OVER  
1.25µm MIN. NICKEL OVERALL.  
(6) 2.50µm MIN. TIN OVERALL  
1.25µm MIN. NICKEL OVERALL
- PRODUCT SPECIFICATION: PS-87920-019
- PACKAGING TYPE: SEE TABLE
- PACKAGING SPEC:  
TUBE WITH CAP VERSION: PK-89990-558  
TUBE W/O CAP VERSION: PK-89990-545  
EMBOSS TAPE WITH CAP: PK-87898-400
- WAFER TO BE FLAT WITHIN 0.003 mm/mm
- BEND DEPRESSION IS ACCEPTED SO LONG AS IT DOES NOT AFFECT THE OVERALL COPLANARITY OF TAIL
- COPLANARITY IS TO BE MEASURED BY RESTING THE SOLDER TAIL ON A FLAT SURFACE
- CAP LOCATION IS CENTERED ALONG THE MATING ENDS AS SHOWN. TOP SURFACE OF CAP TO BE FLAT FOR THE PURPOSE OF PICK & PLACE BY VACUUM SUCTION NOZZLE
- RECOMMENDED PCB THICKNESS IS 1.60mm±0.10

THIS DRAWING CONTAINS INFORMATION THAT IS PROPRIETARY TO MOLEX ELECTRONIC TECHNOLOGIES, LLC AND SHOULD NOT BE USED WITHOUT WRITTEN PERMISSION											
DIMENSION UNITS		SCALE		CURRENT REV DESC:							
mm		NTS									
GENERAL TOLERANCES (UNLESS SPECIFIED)				EC NO: 745488		DRWN: SUIFR		2023/02/15		CUSTOM HEADER 2.54MM PITCH SINGLE ROW SINGLE WAFER SMT HEADER	
				CHK'D: SUIFR		2023/04/10					
				APPR: MRAMAKRISHNA		2023/04/10		PRODUCT CUSTOMER DRAWING			
				INITIAL REVISION:		DRWN: GGUNAGI		2016/11/09		DOCUMENT NUMBER	
				APPR: ISHWARG		2016/12/06		SD-87898-001		DOC TYPE DOC PART REVISION	
ANGULAR TOL ± 3.0°				THIRD ANGLE PROJECTION		DRAWING		SERIES		MATERIAL NUMBER	
DRAFT WHERE APPLICABLE MUST REMAIN WITHIN DIMENSIONS						A3-SIZE		87898		CUSTOMER	
				SEE TABLE		GENERAL MARKET		SHEET NUMBER			
								21 OF 21			