

**SPECIFICATION SHEET**

|                                |   |
|--------------------------------|---|
| <b>SPECIFICATION SHEET NO.</b> | N0530-FM450K0000S115  |
| <b>DATE</b>                    | May 30, 2021  |
| <b>REVISION</b>                | A0  |
| <b>DESCRIPTION</b>             | <p>KHz SMD Ceramic Filter 12065 Type</p> <p>L12.0*W6.5*H3.0mm, 4 Pads CFTC W Series</p> <p>450.0KHz, Insertion Loss. 4.0dB Max.; 6dB Bandwidth: +/-6.0KHz Min.</p> <p>Group Delay Time (GDT) Ripple Deviation: 30.0 μSec. Max. @ F0 +/-4KHz</p> <p>Operating Temp. Range -20°C ~+80°C, Reflow Profile Condition 260 °C Max.</p> <p>Tape/Reel, RoHS/RoHS III compliant</p> |
| <b>CUSTOMER</b>                |   |
| <b>CUSTOMER PART NUMBER</b>    |   |
| <b>CROSS REF. PART NUMBER</b>  |   |
| <b>ORIGINAL PART NUMBER</b>    | TGS CFTC 450KFW TLF   |
| <b>PART CODE</b>               | FM450K0000S115  |

|                         |   |  |   |
|-------------------------|---|--|---|
| <b>VENDOR APPROVE</b>   |   |  |   |
| Issued/Checked/Approved |  |  |  |
| DATE: May 30, 2021      |   |  |   |

|                         |  |
|-------------------------|--|
| <b>CUSTOMER APPROVE</b> |  |
|                         |  |
| DATE:                   |  |

**KHZ SMD CERAMIC FILTER CFTC W SERIES**

**MAIN FEATURE**

- KHz SMD Ceramic Filter 12065 Type 4 pads
- White case, L12.0\*W6.5\*H3.0mm
- Low cost and short shipment
- Reflow Profile Condition 260 °C Max.
- Cross more competitors part CFWKG
- Group Delay Time (GDT)
- RoHS/RoHS III compliant



**APPLICATION**

- Bluetooth, wireless communication set
- Communication Electronics

**RFQ**

[Request For Quotation](#)

**PART CODE GUIDE**

|           |                 |          |            |
|-----------|-----------------|----------|------------|
| <b>FM</b> | <b>450K0000</b> | <b>S</b> | <b>115</b> |
| 1         | 2               | 3        | 4          |

- 1) FM: Part family Code for KHz SMD Ceramic Filter 12065 Type L12.0\*W6.5\*H3.0mm 4 Pads CFTC W Series
- 2) 450K0000: Frequency range code for 450.0000KHz
- 3) S: SMD type, Package Tape/Reel, 1000pcs/Reel
- 4) 115: Specification code for original part No.: **TGS CFTC 450KFW TLF**

**KHZ SMD CERAMIC FILTER CFTC W SERIES**

**DIMENSION (Unit: mm, Tol. +/-0.15mm)**

Image for reference

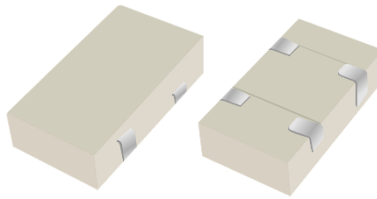

CFTC W

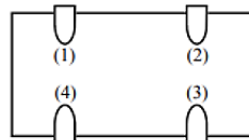
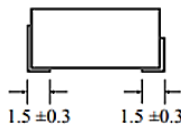
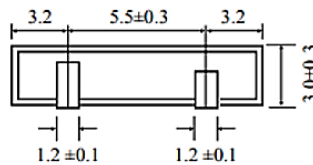
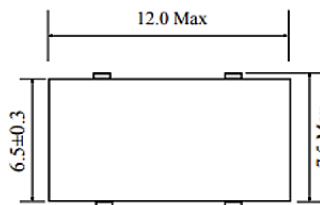

**Marking**

Line 1: Series Code  
Line 2: Frequency Range  
+Internal Code

**Connection**

Pad (1): Input  
Pad (2): Output  
Pad (3): Ground  
Pad (4): Ground

Test Circuit

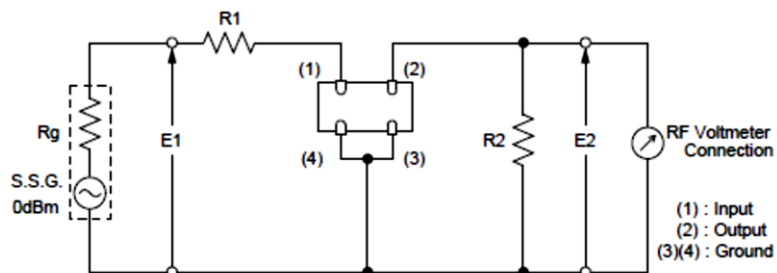

(1) : Input  
(2) : Output  
(3)(4) : Ground

$R_g + R_1 = R_2 = \text{Output/input Impedance}$

**KHZ SMD CERAMIC FILTER CFTC W SERIES**
**ELECTRICAL PARAMETERS**

| Parameter                              | Part No. Symbol | Units                  | Value                            |         |                 | Condition         |
|--|-----------------|------------------------|----------------------------------|---------|-----------------|-------------------|
|  |                 |                        | Min.                             | Typical | Max.            |                   |
| Original Manufacturer                  | TGS             | TGS Crystals           |                                  |         |                 |                   |
| Holder Type                            | CFTC            | KHz SMD Ceramic Filter |                                  |         |                 |                   |
| Frequency Range (f0)                   | 450             | KHz                    | 450.00                           |         | @fo±1.0KHz, 6dB |                   |
| GDT Ripple deviation                   | K               | µSec                   |                                  |         | 30.0            | @fo±4.0 kHz       |
| Temperature Stability                  |                 | %                      |                                  |         | ±0.5            | @ - 20°C ~ +80°C  |
| Operation Temperance                   |                 | °C                     | -20                              |         | +80             |                   |
| Storage Temperance                     |                 | °C                     | -40                              |         | +85             |                   |
| Stop Band Attenuation                  |                 | dB                     | 45                               |         |                 | @fo±100KHz        |
| Bandwidth                              | F               | KHz                    | ±4.0                             |         |                 | @3 dB             |
|  |                 | KHz                    | ±6.00                            |         |                 | @6 dB             |
|  |                 | KHz                    | ±17.5                            |         |                 | @50 dB            |
| Insertion Loss (At minimum loss point) |                 | dB                     |                                  |         | 4.0             |                   |
| Ripple                                 |                 | dB                     |                                  |         | 1.0             | @f0±4.0kHz        |
| Spurious Response                      |                 | dB                     | 20.0                             |         |                 | @0.1~1.0MHz       |
| Input/Output Impedance                 |                 | Ω                      | 1500                             |         |                 |                   |
| Insulation Resistance                  |                 | MΩ                     | 100                              |         |                 | @DC 25V 1 minute) |
| Pads Code                              | W               |                        | L12.0*W6.5*H3.0mm 4 Pads         |         |                 |                   |
| Other                                  | Package         | T                      | Tape/Reel, 1000pcs/Reel          |         |                 |                   |
|  | RoHS Status     | LF                     | RoHS III compliant               |         |                 |                   |
|  | Add Value       |                        | N/A                              |         |                 |                   |
|  | Special Code    |                        | For Internal Control, Blank: N/A |         |                 |                   |

Note:

Original Part Number: TGS CFTC 450KFW TLF

4

**KHZ SMD CERAMIC FILTER CFTC W SERIES**
**RELIABILITY**

| Test Items                       | Test Method And Conditions   | Requirement   |
|----------------------------------|--|---|
| <b>Humidity</b>                  | After being placed in a chamber with 90-95% R.H. at 40±2°C for 100 hours and then being placed in room temperature for 1 hour, filter shall be measured.   | It shall meet Table 1.                                    |
| <b>High Temperature</b>          | After being placed in a chamber with 80±2 °C, for 100 hours and then being placed in room temperature for 1 hour, filter shall be measured.  | It shall meet Table 1.                                    |
| <b>Low Temperature</b>           | After being placed in a chamber with -20±2 °C, for 100 hours and then being placed in room temperature for 1 hour, filter shall be measured.   | It shall meet Table 1.                                    |
| <b>Heat Shock</b>                | After being kept at room temperature, filter shall be placed at temperature of -55 °C , for 30 minutes, then be placed at temperature. 85 °C, for 30 minutes. After that returned to -55 °C again. Repeated above cycle for 5 times. After being kept in room temp. for 1 hour, filter shall be measured | It shall meet Table 1.                                    |
| <b>Resistance to Solder Heat</b> | Lead terminals are immersed up to 1.5mm from filter’s body in soldering bath of 350± 10°C, for 3±0.5 sec. And then filter shall be measured after being placed in room temperature for 1 hour.   | It shall meet Table 1.                                    |
| <b>Solderability</b>             | Lead terminals are immersed in aide solder for 5 sec and then immersed in soldering bath of 230±5°C, for 3±0.5 sec.  | At least 95% lead terminals shall be covered with solder. |
| <b>Drop Test</b>                 | Filter shall be measured after 3 times random drops from the height of 30 cm on concrete floor   | No visible damage and it meet Table 1                     |
| <b>Adhesion</b>                  | A static load of 20N to the direction of the arrow (see Fig. 4) shall be applied on the core of the Component and hold for 10 seconds. Filter shall be soldered correctly and tightly to PCB.  | It shall meet Table 1.                                    |
| <b>Vibration</b>                 | Filter shall be measured after being applied vibration of amplitude of 1.5mm with 10-55Hz band of vibration frequency to each of 3 perpendicular directions for 2 hours  | No visible damage and it meet Table 1                     |
| <b>Substrate Bending Test</b>    | Apply pressure in the direction of arrow (see Fig. 3) at a rate of about 0.5mm per second until it reaches a bend of 3mm and hold for 30 seconds.  | It shall meet Table 1.                                    |

**Table1**

| Item          | Center Frequency | Band width (6dB) | Band width (50dB) | Stop Band Attenuation (fo±100KHz) | Ripple (fo±4KHz) | Insertion Loss |
|---------------|------------------|------------------|-------------------|-----------------------------------|------------------|----------------|
| Specification | 450±1.0 KHz Max. | ±6.0 KHz Min.    | ±17.5 KHz Min.    | 45.0 dB Min.                      | 1.0 dB Max       | 4.0 dB Max     |

**KHZ SMD CERAMIC FILTER CFTC W SERIES**

**SUGGESTED REFLOW PROFILE (For Reference Only)**



|  |                                  |                   |
|--|----------------------------------|-------------------|
| <b>Profile Feature</b>                                 |                                  | Pb-Free Assembly  |
| <b>Average Ramp-up Rate (Ts Max to Tp)</b>             |                                  | 3°C/second Max    |
| <b>Preheat</b>   | <b>Temperature Min (Ts Min.)</b> | 125°C             |
|  | <b>Temperature Max (Ts Max.)</b> | 200°C             |
|  | <b>Time (ts Min. to ts Max.)</b> | 60 ~ 180 seconds  |
| <b>Time maintained above</b>                           | <b>Temperature (Tl)</b>          | 217°C             |
|  | <b>Time (tL)</b>                 | 60 ~ 150 seconds  |
| <b>Peak/Classification Temperature (Tp)</b>            |                                  | 260 °C            |
| <b>Time within 5°C of actual Peak Temperature (tp)</b> |                                  | 20 ~ 40 seconds   |
| <b>Ramp-down rate</b>                                  |                                  | 6 °C /Second Max. |
| <b>Time 25 °C to Peak Temperature</b>                  |                                  | 8 minutes Max.    |
| <b>Suggest reflow times</b>                            |                                  | 3 Times Max.      |

**KHZ SMD CERAMIC FILTER CFTC W SERIES**

**REEL DIMENSION (Unit: mm, 1000pcs/Reel)**

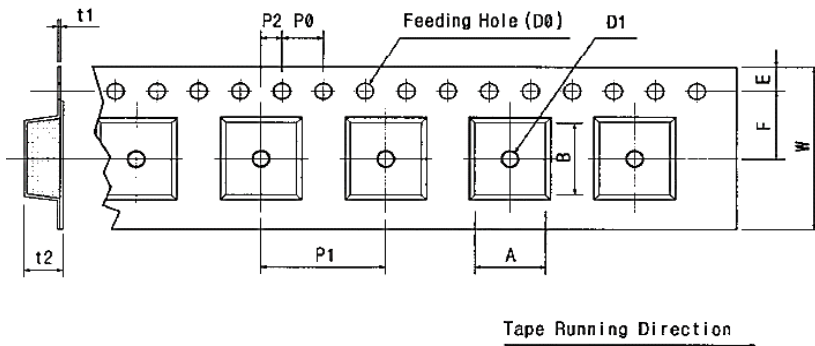

| Code | Dimension   |
|------|-------------|
| W    | 24.0+/-0.30 |
| F    | 11.5+/-0.05 |
| E    | 1.75+/-0.10 |
| P 0  | 4.00+/-0.10 |
| P 1  | 12.0+/-0.10 |
| P 2  | 2.00+/-0.05 |
| D 0  | Ø1.5+/-0.10 |
| D 1  | Ø1.0+/-0.25 |
| t 1  | 0.35+/-0.10 |
| t 2  | 3.20+/-0.10 |
| A    | 7.70+/-0.10 |
| B    | 12.0+/-0.10 |

**TAPE DIMENSION (Unit: mm)**



| Code | Dimension   |
|------|-------------|
| A    | Ø180+/-1.0  |
| B    | Ø60+/-0.5   |
| C    | Ø13.0+/-0.5 |
| E    | 2.00+/-0.5  |
| W    | 17.0+/-1.0  |
| T    | 19.4+/-0.3  |



**DISCLAIMER**

NextGen Components, Inc. reserves the right to make changes to the product(s) and or information contained herein without notice. No liability is assumed as a result of their use or application. No rights under any patent accompany the sale of any such product(s) or information