



## SPECIFICATION

---

*easy* // TOUCH  
DISPLAY

### easyTOUCH DISPLAY - STARTER KIT

13.3" - FHD – eMotion ST1:3

Version: 1.0

Date: 08.06.2020

Note: This specification is subject to change without prior notice

## **Table of Contents**

<b>1. easyTOUCH Display</b>	<b>P. 03</b>
<b>1.1. Starter Kit Quick Start Guide</b>	<b>P. 05</b>
<b>1.2. 13.3”FHD Color TFT-LCD</b>	<b>P. 10</b>
<b>1.3. 13.3” PCAP Solution</b>	<b>P. 34</b>
<b>1.4. easyTOUCH mXT2952T2 2-Tail USB Controller</b>	<b>P. 39</b>
<b>2. eMotion board</b>	<b>P. 47</b>
<b>3. OSD board</b>	<b>P. 63</b>
<b>4. DVI/HDMI cable</b>	<b>P. 69</b>
<b>5. LVDS cable</b>	<b>P. 70</b>
<b>6. LED cable</b>	<b>P. 71</b>
<b>7. OSD cable</b>	<b>P. 72</b>
<b>8. USB cable</b>	<b>P. 73</b>
<b>9. +12V Power supply</b>	<b>P. 75</b>
<b>10. Power cord (EU)</b>	<b>P. 79</b>
<b>11. Power cord (US)</b>	<b>P. 80</b>



## ADVANCED LEVEL

**13.3 inch (33.8cm)**

**Part-No. 12035525**

**G133HAN01.0 incl. easyTOUCH eTD133W3202-AUA-A**

### Display

Panel Type	AUO G133HAN01.0
Resolution (pixel) / format	1920 x 1080/ wide
Brightness (typical)	400 cd/m <sup>2</sup>
Display Mode	VA, Normally black
Customer Interface Display	LVDS
Contrast ratio (typical)	800:1
Backlight	LED

### Glass and Touch

Cover glass	2mm Glare Glass, chemically strengthened, no treatment Printing RAL9005 organic Dimensions according to outline drawing
Touch sensor type	13.3" easyTOUCH
Active area touch sensor (W x H)	295.1 (H) x 166.7 (V)
Optical Specification	according to DATA MODUL Outgoing Specification 12005965
Touch Interface	USB mXT2952T2

### Assembling

Glass to touch	Optically bonded
Glass/Touch assembly to display	AirGap-Bonding with 4 stripes industrial double-sided adhesive tape
Touch Controllerboard	mounted on rear side of TFT with metal bracket

### Accessories

Touch Controller	easyTOUCH mXT2952T2 Driverless USB
------------------	------------------------------------

### Environmental conditions

Temperature (operating)	0 - 70 °C
-------------------------	-----------

### Mechanical dimensions

Outline dimensions (W x H x T)	328.4 (H) x 200.0 (V) x 13.7 (T) Detailed dimensions according to outline drawing
Weight	approx. 1.1 kg

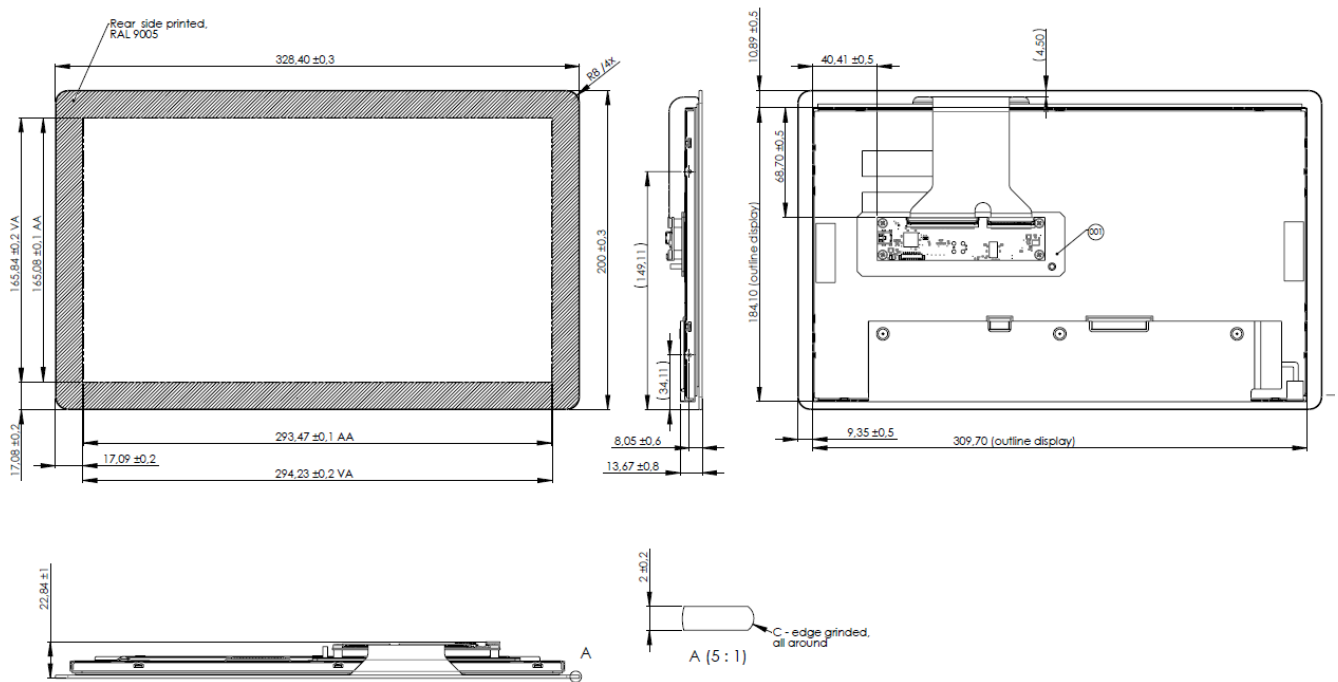



easyTOUCH DISPLAY  
**STARTERKIT**

---

QUICK START GUIDE

**DATA MODUL**

---

THE DISPLAY EXPERTS

## SCOPE OF DELIVERY

---

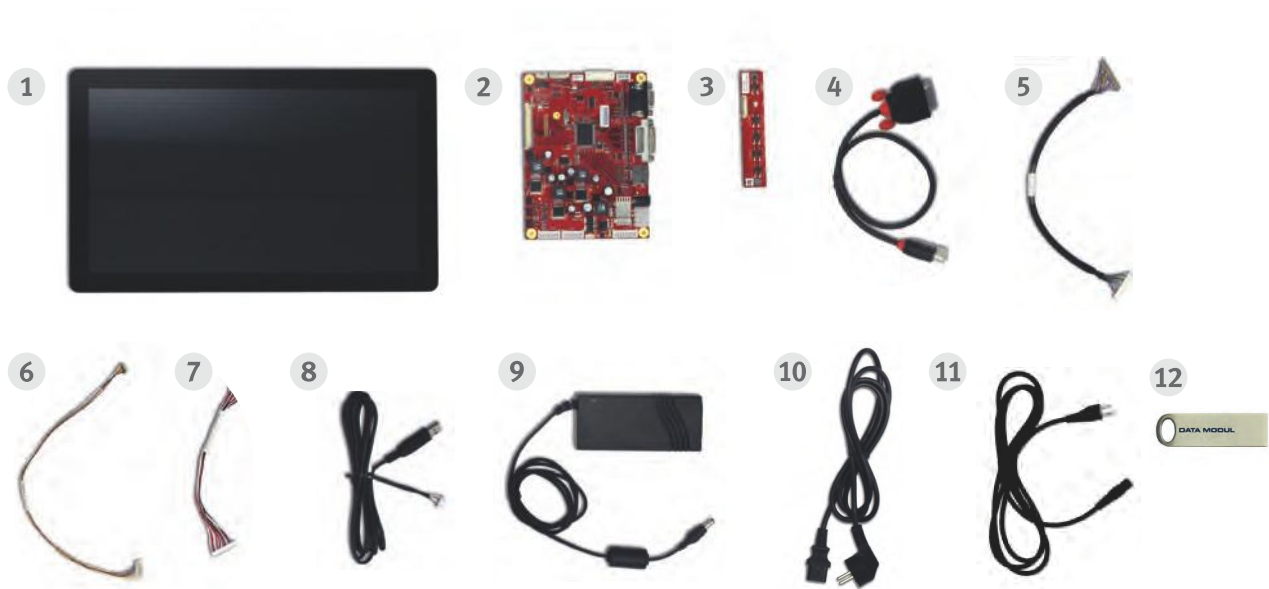

- |   |                   |    |                                   |
|---|-------------------|----|-----------------------------------|
| 1 | easyTOUCH Display | 7  | OSD cable                         |
| 2 | eMotion board*    | 8  | USB cable                         |
| 3 | OSD board         | 9  | +12V power supply                 |
| 4 | DVI/HDMI cable    | 10 | Power cord (EU)                   |
| 5 | LVDS cable        | 11 | Power cord (US)                   |
| 6 | LED cable         | 12 | easyANALYZER software (USB stick) |

\*Connector numberings (CN) can be found on the front of the eMotion board.  
Connector descriptions can be found on the back of the eMotion board.

## INTRO

---

THANK YOU for choosing  
our easyTOUCH STARTERKIT!



This kit provides you with all the necessary components to bring our touch-display solution to full operation. The components can be assembled together in just a few steps using our guidelines! The perfect combination of our in-house developed easyTOUCH Display and eMotion board enable you to evaluate our PCAP and display performance. Further PCAP tuning and debugging is possible using the easyANALYZER software developed by our engineers for our easyTOUCH solutions. If you have any questions or challenges, do not hesitate to contact us!

Do you need more details or do you need support for a special project?

Contact us for further information or individual project support: [touch@data-modul.com](mailto:touch@data-modul.com)

## INSTALL GUIDE

---

1

Connect easyTOUCH Display **1** with eMotion board **2** by using LVDS cable **5** (CN105) and LED cable **6** (CN108)

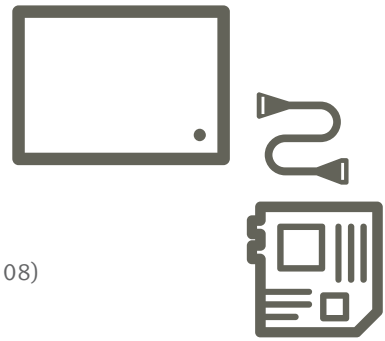

2

Connect OSD board **3** with eMotion board **2** by using OSD cable **7** (CN112)

3

Connect USB cable **8** with USB touch controller board on the back side of the easyTOUCH Display **1**

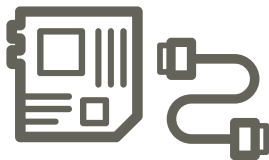

4

Connect DVI cable **4** with eMotion board **2** (CN100)



5

Connect HDMI **4** and  
USB cable **8** to your host system

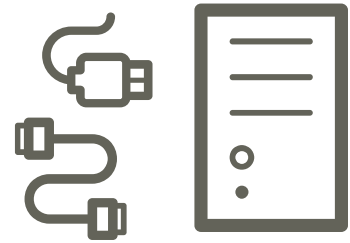

6

After ALL other connections have been made,  
supply +12V power **9** to eMotion board **2**.  
Plug in power cord **10** (EU) / **11** (US)

7

Optional:  
Install easyANALYZER software **12**  
on your host system (for Windows and Linux)



Let's start!





## Contents

<b>1. Handling Precautions</b> .....	<b>5</b>
<b>2. General Description</b> .....	<b>6</b>
2.1 General Specification .....	6
2.2 Optical Characteristics .....	7
<b>3. Functional Block Diagram</b> .....	<b>11</b>
<b>4. Absolute Maximum Ratings</b> .....	<b>12</b>
4.1 Absolute Ratings of TFT LCD Module.....	12
4.2 Absolute Ratings of Environment .....	12
<b>5. Electrical Characteristics</b> .....	<b>13</b>
5.1 TFT LCD Module.....	13
5.2 Backlight Unit .....	15
<b>6. Signal Interface Characteristic</b> .....	<b>16</b>
6.1 Pixel Format Image .....	16
6.2 The Input Data Format .....	17
6.3 Signal Description (CN1).....	18
6.4 Interface Timing (LVDS).....	19
6.5 Power ON/OFF Sequence .....	20
<b>7. Connector &amp; Pin Assignment</b> .....	<b>21</b>
7.1 TFT LCD Module.....	21
7.2 Backlight Unit .....	22
<b>8. Panel Reliability Test</b> .....	<b>24</b>
<b>9. Label and Package</b> .....	<b>25</b>
9.1 Shipping Label Format .....	25
9.2 Carton Package .....	25
<b>10 .Mechanical Characteristics</b> .....	<b>26</b>
10.1 LCM Outline Dimension (Front View) .....	26
10.2 LCM Outline Dimension (Rear View).....	27





## 1. Handling Precautions

- 1) Since front polarizer is easily damaged, please be cautious and not to scratch it.
- 2) Be sure to turn off power supply when inserting or disconnecting from input connector.
- 3) Wipe off water drop immediately. Long contact with water may cause discoloration or spots.
- 4) When the panel surface is soiled, wipe it with absorbent cotton or soft cloth.
- 5) Since the panel is made of glass, it may be broken or cracked if dropped or bumped on hard surface.
- 6) To avoid ESD (Electro Static Discharge) damage, be sure to ground yourself before handling TFT-LCD Module.
- 7) Do not open nor modify the module assembly.
- 8) Do not press the reflector sheet at the back of the module to any direction.
- 9) In case if a module has to be put back into the packing container slot after it was taken out from the container, do not press the center of the LED light bar edge. Instead, press at the far ends of the LED light bar edge softly. Otherwise the TFT Module may be damaged.
- 10) At the insertion or removal of the Signal Interface Connector, be sure not to rotate nor tilt the Interface Connector of the TFT Module.
- 11) TFT-LCD Module is not allowed to be twisted & bent even force is added on module in a very short time. Please design your display product well to avoid external force applying to module by end-user directly.
- 12) Small amount of materials without flammability grade are used in the TFT-LCD module. The TFT-LCD module should be supplied by power complied with requirements of Limited Power Source (IEC60950-1 or UL60950-1), or be applied exemption.
- 13) Severe temperature condition may result in different luminance, response time and lamp ignition voltage.
- 14) Continuous operating TFT-LCD display under low temperature environment may accelerate lamp exhaustion and reduce luminance dramatically.
- 15) The data on this specification sheet is applicable when LCD module is placed in landscape position.
- 16) Continuous displaying fixed pattern may induce image sticking. It's recommended to use screen saver or shuffle content periodically if fixed pattern is displayed on the screen.







# Product Specification

AU OPTRONICS CORPORATION

## 2. General Description

G133HAN01.0 is a Color Active Matrix Liquid Crystal Display composed of a TFT LCD panel, a driver circuit, and LED backlight system. The screen format is intended to support the 16:9 FHD, 1920(H) x1080(V) screen and 16.7M colors (RGB 8-bits data driver) with LED backlight driving circuit.

G133HAN01.0 is designed for a display unit of industrial machine.

### 2.1 General Specification

The following items are characteristics summary on the table at 25 °C condition:

Items	Unit	Specifications
Screen Diagonal	[inch]	13.3"
Active Area	[mm]	293.472 (H) x 165.078 (V)
Pixels H x V		1920 x 3(RGB) x 1080
Pixel Pitch	[mm]	0.15285x 0.15285
Pixel Format		R.G.B. Vertical Stripe
Display Mode		AHVA
White Luminance ( Center )	[cd/m <sup>2</sup> ]	400 Typ.
Luminance Uniformity		80% (5 points, Typ.)
Contrast Ratio		800:1 (Typ.)
Response Time	[ms]	25 (Typ.)/ 35 (Max.)
Nominal Input Voltage VDD	[Volt]	+3.3 (Typ.)
LCD Power Consumption	[Watt]	1.8 W (Max. White Pattern)
LED Power Consumption	[Watt]	15W (Max.)
Weight	[Grams]	500 (Max.)
Physical Size	[mm]	309.7 x 184.1 x 9.6 (Typ.)
Electrical Interface		LVDS
Surface Treatment		Anti-glare
Support Color		16.7M Colors ( RGB 8-bits )
Temperature Range		
Operating	[°C]	-20 to +70
Storage (Non-Operating)	[°C]	-20 to +70





# Product Specification

AU OPTRONICS CORPORATION

## 2.2 Optical Characteristics

The optical characteristics are measured under stable conditions at 25°C (Room Temperature) :

Item	Unit	Conditions	Min.	Typ.	Max.	Note	
Central Luminance	cd/m <sup>2</sup>		320	400	---	1, 3, 4	
Viewing Angle	degree	Horizontal (Right) CR = 10 (Left)	75 75	89 89	--- ---	3, 7	
		Vertical (Upper) CR = 10 (Lower)	75 75	89 89	--- ---		
Luminance Uniformity		5 Points	75	80	---	1, 2, 3	
Contrast Ratio			600	800	-	3, 5	
Response Time	msec	Rising + Falling	---	25	35	3, 6	
Color / Chromaticity Coodinates	Red	Rx	CIE 1931	0.625	0.675	0.725	3
		Ry		0.266	0.316	0.366	
	Green	Gx		0.235	0.285	0.335	
		Gy		0.605	0.655	0.705	
	Blue	Bx		0.103	0.153	0.203	
		By		0.000	0.036	0.086	
	White	Wx		0.263	0.313	0.363	
		Wy		0.279	0.329	0.379	
NTSC	%		-	90	-		





# Product Specification

AU OPTRONICS CORPORATION

**Note 1:** 5 points position (Ref: Active area)

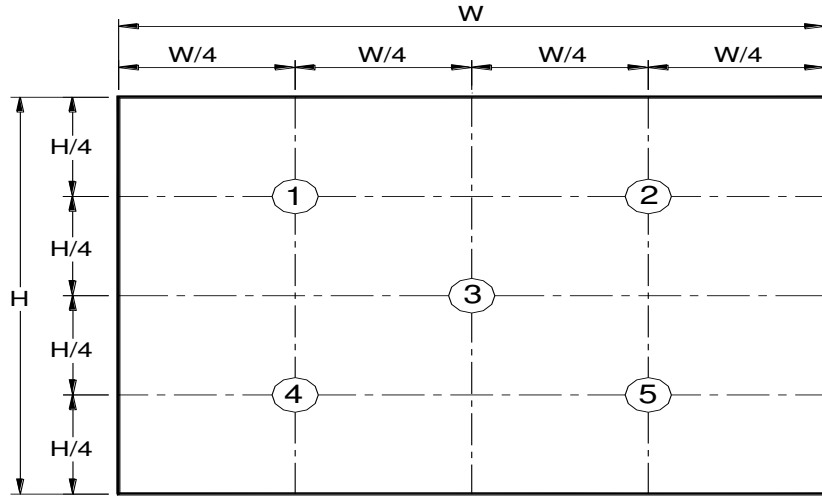

**Note 2:** The luminance uniformity of 5 points is defined by dividing the maximum luminance values by the minimum test point luminance

$$\delta_{w5} = \frac{\text{Maximum Brightness of five points}}{\text{Minimum Brightness of five points}}$$

**Note 3:** Measurement method

The LCD module should be stabilized at given temperature for 30 minutes to avoid abrupt temperature change during measuring. In order to stabilize the luminance, the measurement should be executed after lighting Backlight for 30 minutes in a stable, windless and dark room, and it should be measured in the center of screen.



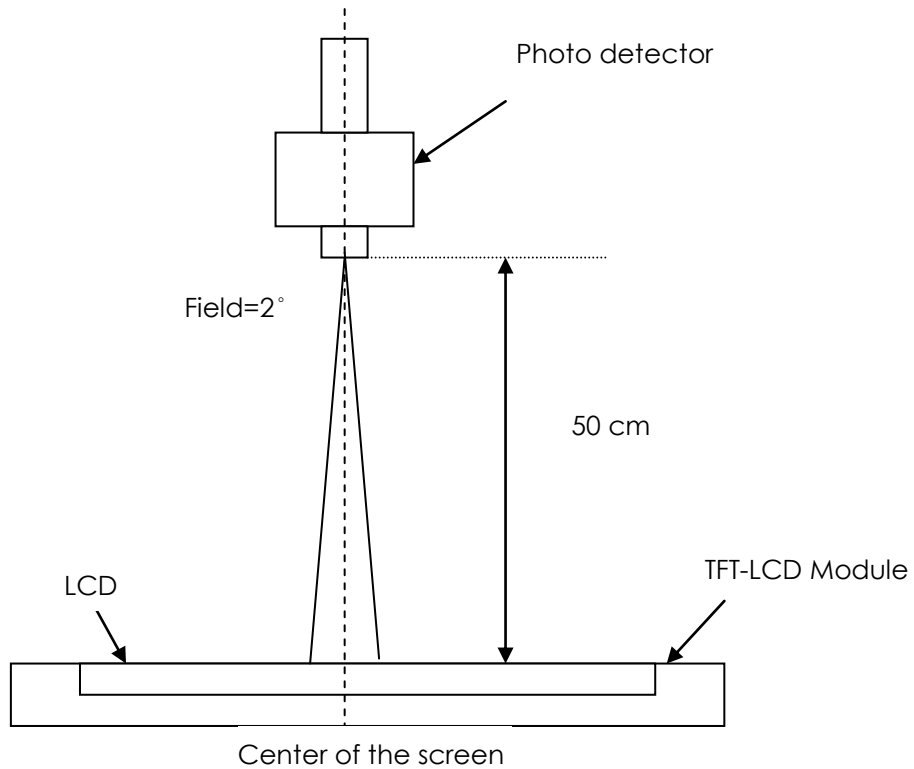

**Note 4:** Definition of Average Luminance of White (Y<sub>L</sub>):

Measure the luminance of gray level 63 at 5 points ,  $Y_L = [L (1)+ L (2)+ L (3)+ L (4)+ L (5)] / 5$

L (x) is corresponding to the luminance of the point X at Figure in Note (1).

**Note 5:** Definition of contrast ratio:

Contrast ratio is calculated with the following formula.

$$\text{Contrast ratio (CR)} = \frac{\text{Brightness on the "White" state}}{\text{Brightness on the "Black" state}}$$







# Product Specification

AU OPTRONICS CORPORATION

**Note 6:** Definition of response time:

The output signals of BM-7 or equivalent are measured when the input signals are changed from "Black" to "White" (falling time) and from "White" to "Black" (rising time), respectively. The response time interval is between the 10% and 90% of amplitudes. Refer to figure as below.

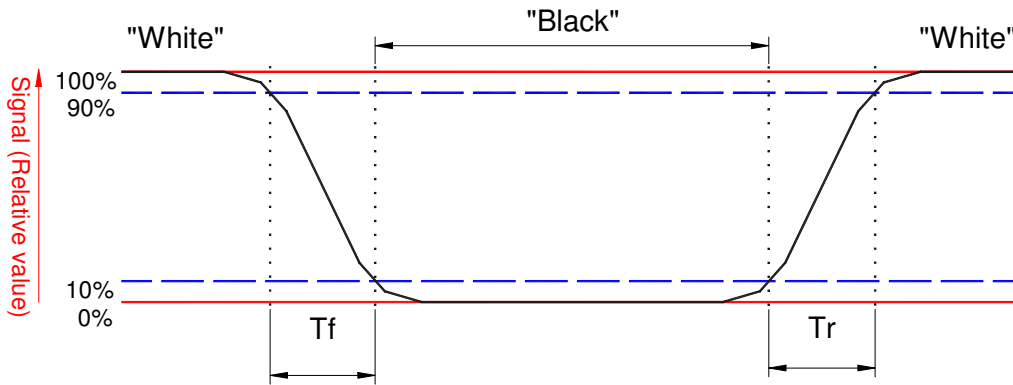

**Note 7:** Definition of viewing angle

Viewing angle is the measurement of contrast ratio >10, at the screen center, over a 180° horizontal and 180° vertical range (off-normal viewing angles). The 180° viewing angle range is broken down as follows; 90° ( $\theta$ ) horizontal left and right and 90° ( $\Phi$ ) vertical, high (up) and low (down). The measurement direction is typically perpendicular to the display surface with the screen rotated about its center to develop the desired measurement viewing angle.

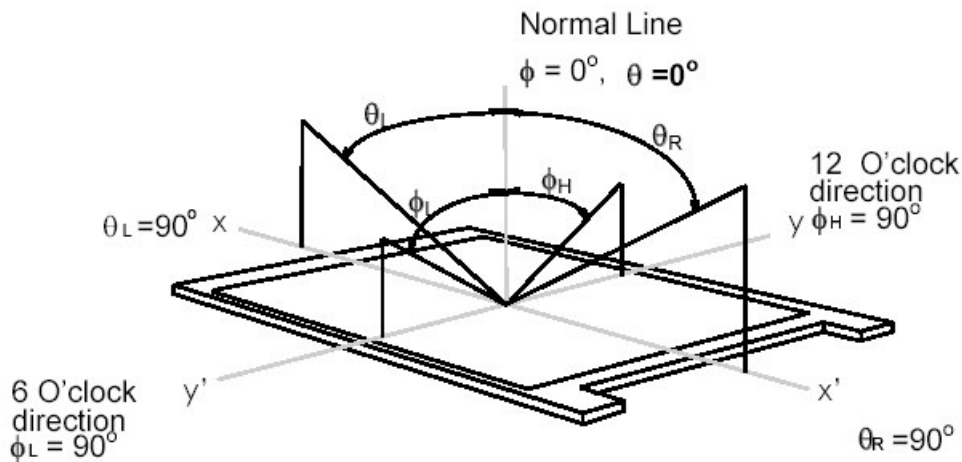



### 3. Functional Block Diagram

The following diagram shows the functional block of the 13.3 inch Color TFT-LCD Module:

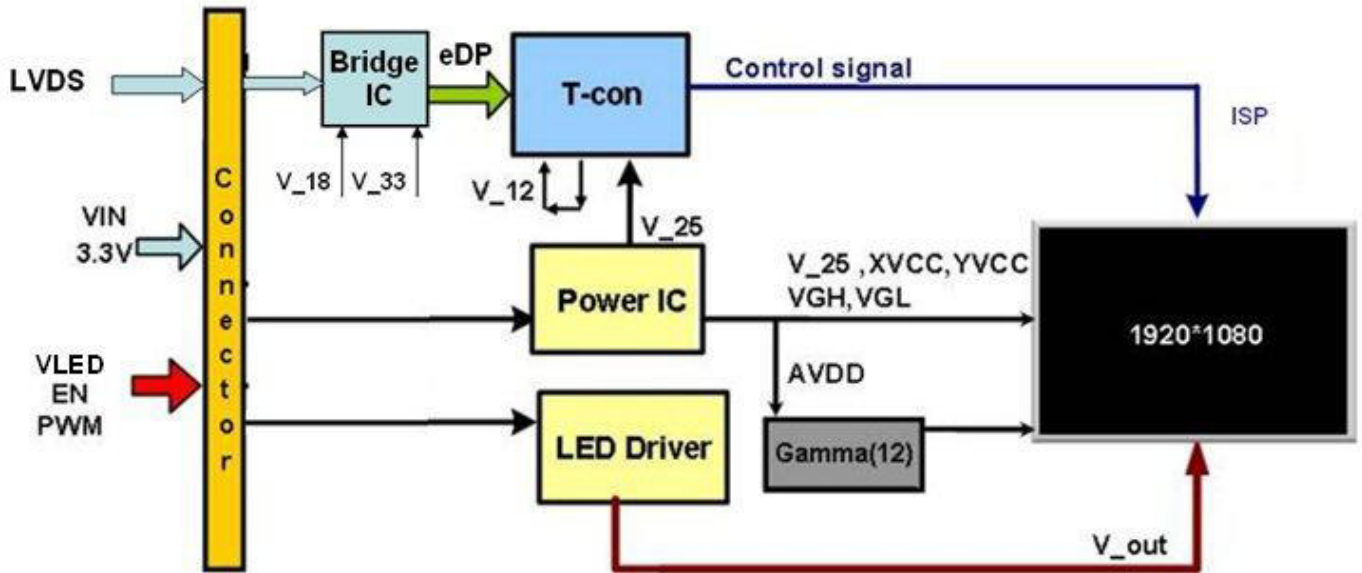



## 4. Absolute Maximum Ratings

An absolute maximum rating of the module is as following:

### 4.1 Absolute Ratings of TFT LCD Module

Item	Symbol	Min	Max	Unit	Conditions
Logic/LCD Drive Voltage	VDD	-0.3	+4.0	[Volt]	Note 1,2
BL Input Voltage	VLED	-0.3	+34.0	[Volt]	Note 1,2
Signal Voltage	RinI-/+ , ClkIN-/+	-0.3	VDD+0.3	[Volt]	Note 1, I=0,1,2,3
Signal Voltage	LED_EN , LED_PWM	-0.3	+5.5	[Volt]	Note 1,2

### 4.2 Absolute Ratings of Environment

Item	Symbol	Min	Max	Unit	Conditions
Operating Temp.	TOP	-20	+70	[°C]	Note 4
Operation Humidity	HOP	8	90	[%RH]	Note 4
Storage Temperature	TST	-20	+70	[°C]	Note 4
Storage Humidity	HST	5	90	[%RH]	Note 4

**Note 1:** At Ta (25°C)

**Note 2:** Permanent damage to the device may occur if exceed maximum values

**Note 3:** LED specification refer to section 5.2

**Note 4:** For quality performance, please refer to AUO IIS (Incoming Inspection Standard)





## 5. Electrical Characteristics

### 5.1 TFT LCD Module

#### 5.1.1 Power Specification

Input power specifications are as follows;

The power specification are measured under 25°C and frame frequency under 60Hz

Symbol	Parameter	Min	Typ	Max	Units	Note
VDD	Logic/LCD Drive Voltage	3.0	3.3	3.6	[Volt]	
PDD	VDD Power	-	-	1.8	[Watt]	Note 1
IDD	IDD Current	-	-	500	[mA]	Note 1
IRush	Inrush Current	-	-	2	[A]	Note 2
VDDrp	Allowable Logic/LCD Drive Ripple Voltage	-	-	200	[mV] p-p	

**Note 1:** Maximum Measurement Condition : White Pattern at 3.6V driving voltage ( $P_{max}=V_{3.6} \times I_{white}$ )

**Note 2:** Measure Condition

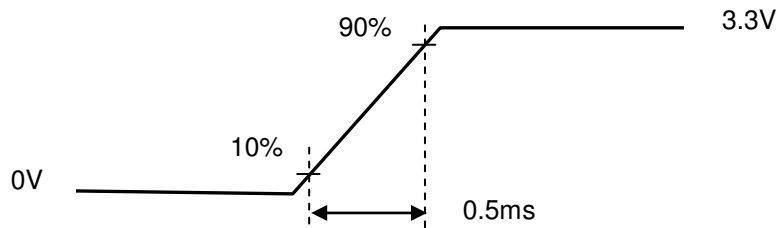
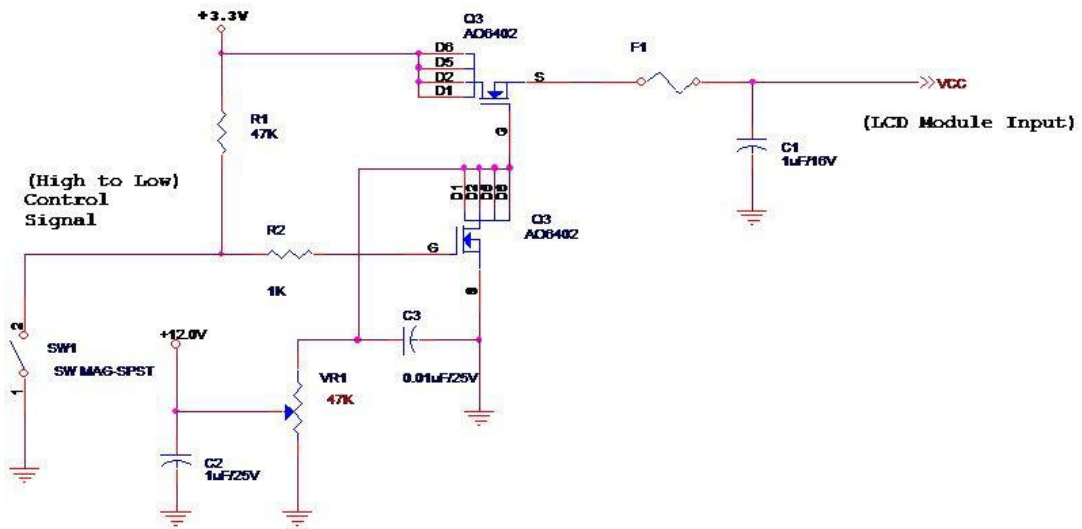

Vin rising time





# Product Specification

AU OPTRONICS CORPORATION

## 5.1.2 Signal Electrical Characteristics

Input signals shall be low or High-impedance state when VDD is off.

Signal electrical characteristics are as follows;

Symbol	Parameter	Min	Typ	Max	Units	Condition
$V_{TH}$	Differential Input High Threshold	-	-	+100	[mV]	$V_{CM} = 1.2V$ Note 1
$V_{TL}$	Differential Input Low Threshold	-100	-	-	[mV]	$V_{CM} = 1.2V$ Note 1
$ V_{ID} $	Input Differential Voltage	100	400	600	[mV]	Note 1
$V_{CM}$	Differential Input Common Mode Voltage	+1.125	-	+1.375	[Volt]	$V_{TH} - V_{TL} = 200mV$ (max) Note 1

**Note 1:** LVDS Signal Waveform

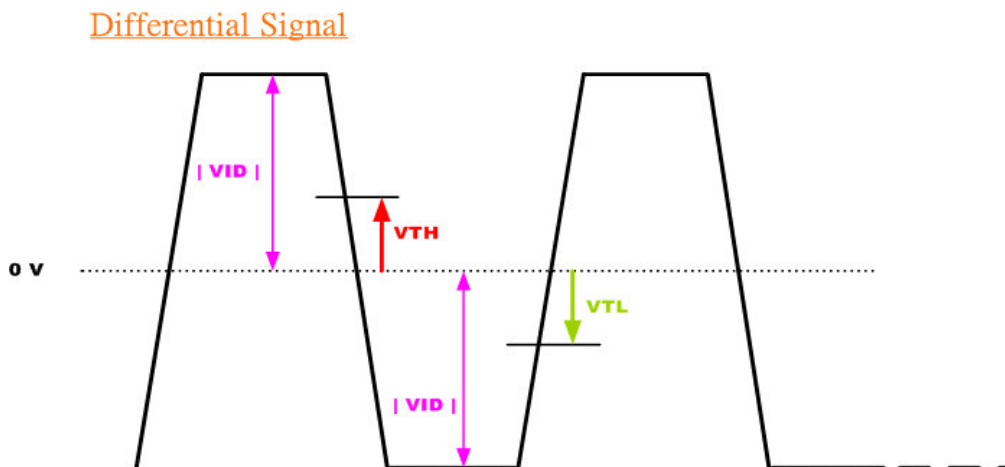
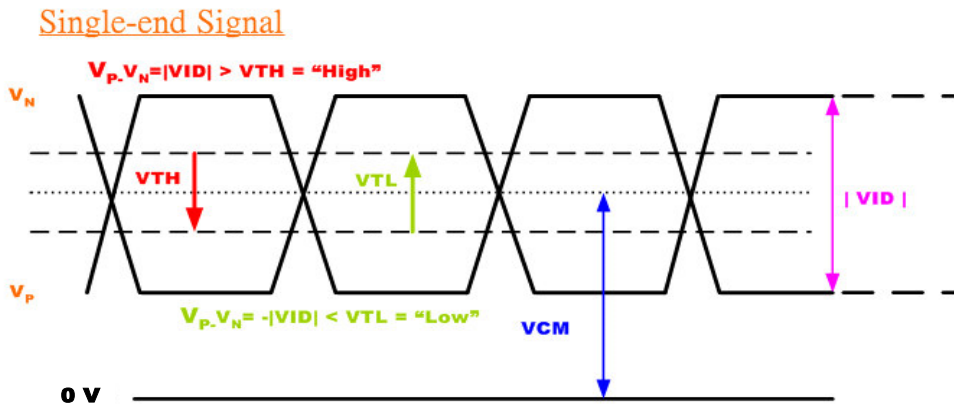



## 5.2 Backlight Unit

### 5.2.1 LED characteristics

Parameter	Symbol	Min	Typ	Max	Units	Condition
Backlight Power Consumption	PLED	-	-	15W	[Watt]	(Ta=25°C), Note 1
LED Life-Time	N/A	-	50,000	-	Hour	(Ta=25°C), Note 2

**Note 1:** Calculator value for reference  $P_{LED} = V_F$  (Normal Distribution) \*  $I_F$  (Normal Distribution) / Efficiency

**Note 2:** The LED life-time define as the estimated time to 50% degradation of initial luminous.

### 5.2.2 Backlight input signal characteristics

Parameter	Symbol	Min	Typ	Max	Units	Remark
LED Power Supply	VLED	10.8	12.0	13.2	[Volt]	Define as Connector Interface (Ta=25°C)
LED Input current	ILED	-	1.25	-	[A]	
LED Enable Input High Level	LED_EN	2	-	5	[Volt]	
LED Enable Input Low Level		-	-	0.8	[Volt]	
PWM Logic Input High Level	LED_PWM	2	-	5	[Volt]	
PWM Logic Input Low Level		-	-	0.52	[Volt]	
PWM Input Frequency	FPWM	500	-	10K	Hz	
PWM Duty Ratio	Duty	5	-	100	%	
LED Inrush Current	ILED <sub>Rush</sub>	-	-	3	[A]	





## 6.2 The Input Data Format

Interface	Type	Data
LVDS	JEIDA	8 bit

### JEIDA / NS Mapping Format (Using JEIDA)

RXIN1D0 N/P RXIN2D0 N/P	J:RA6=G2 N:RA6=G0	J:RA5=R7 N:RA5=R5	J:RA4=R6 N:RA4=R4	J:RA3=R5 N:RA3=R3	J:RA2=R4 N:RA2=R2	J:RA1=R3 N:RA1=R1	J:RA0=R2 N:RA0=R0
RXIN1D1 N/P RXIN2D1 N/P	J:RB6=B3 N:RB6=B1	J:RB5=B2 N:RB5=B0	J:RB4=G7 N:RB4=G5	J:RB3=G6 N:RB3=G4	J:RB2=G5 N:RB2=G3	J:RB1=G4 N:RB1=G2	J:RB0=G3 N:RB0=G1
RXIN1D2 N/P RXIN2D2 N/P	J:RC6=DE N:RC6=DE	J:RC5=VS N:RC5=VS	J:RC4=HS N:RC4=HS	J:RC3=B7 N:RC3=B5	J:RC2=B6 N:RC2=B4	J:RC1=B5 N:RC1=B3	J:RC0=B4 N:RC0=B2
RXIN1D3 N/P RXIN2D3 N/P	J:RD6=X N:RD6=X	J:RD5=B1 N:RD5=B7	J:RD4=B0 N:RD4=B6	J:RD3=G1 N:RD3=G7	J:RD2=G0 N:RD2=G6	J:RD1=R1 N:RD1=R7	J:RD0=R0 N:RD0=R6





### 6.3 Signal Description (CN1)

The module uses one LVDS receiver. LVDS is a differential signal technology for LCD interface and high speed data transfer device. The first LVDS port(RxOxxx) transmits odd pixels while the second LVDS port(RxExxx) transmits even pixels.

Pin	Signal	Description
1	RxOIN0-	Negative LVDS differential data input (Odd data)
2	RxOIN0+	Positive LVDS differential data input (Odd data)
3	RxOIN1-	Negative LVDS differential data input (Odd data)
4	RxOIN1+	Positive LVDS differential data input (Odd data)
5	RxOIN2-	Negative LVDS differential data input (Odd data, DSPTMG)
6	RxOIN2+	Positive LVDS differential data input (Odd data, DSPTMG)
7	GND	Power Ground
8	RxOCLKIN-	Negative LVDS differential clock input (Odd clock)
9	RxOCLKIN+	Positive LVDS differential clock input (Odd clock)
10	RxOIN3-	Negative LVDS differential data input (Odd data)
11	RxOIN3+	Positive LVDS differential data input (Odd data)
12	RxEIN0-	Negative LVDS differential data input (Even data)
13	RxEIN0+	Positive LVDS differential data input (Even data)
14	GND	Power Ground
15	RxEIN1-	Negative LVDS differential data input (Even data)
16	RxEIN1+	Positive LVDS differential data input (Even data)
17	GND	Power Ground
18	RxEIN2-	Negative LVDS differential data input (Even data)
19	RxEIN2+	Positive LVDS differential data input (Even data)
20	RxECLKIN-	Negative LVDS differential clock input (Even clock)
21	RxECLKIN+	Positive LVDS differential clock input (Even clock)
22	RxEIN3-	Negative LVDS differential data input (Even data)
23	RxEIN3+	Positive LVDS differential data input (Even data)
24	GND	Power Ground
25	AGBSEN	For AUO internal use
26	VDD	Power +3.3V
27	VDD	Power +3.3V
28	SCL	For AUO internal use
29	SDA	For AUO internal use
30	GND	Power Ground



## 6.4 Interface Timing (LVDS)

### 6.4.1 Timing Characteristics

Basically, interface timings should match the 1920x1080/ 60Hz manufacturing guide line timing.

Parameter	Symbol	Min.	Typ.	Max.	Unit	
Frame Rate	-	60	60	60	Hz	
Clock frequency	$1/T_{\text{Clock}}$	67	70.6	74.5	MHz	
Horizontal Section	Period	$T_H$	1023	1054	960+B	$T_{\text{clock}}$
	Active	$T_{HD}$	960			
	Blanking	$T_{HB}$	63	94	B	
Vertical Section	Period	$T_V$	1092	1116	1080+A	$T_{\text{line}}$
	Active	$T_{VD}$	1080			
	Blanking	$T_{VB}$	12	36	A	

**Note1 :** The above is as optimized setting

**Note2 :** The maximum clock frequency =  $[(960 + B) \cdot (1080 + A) \cdot 60] < 74.5\text{MHz}$

**Note3 :** Horizontal related parameters must be constant without variation( H\_Sync\_Width, H\_Front\_Porch and H\_Back\_Porch must be constant on each scanline).

**Note4 :** On vertical blank area, H\_Sync\_Width and H\_Total must be same as on the V\_Active area.

**Note5 :** Vertical related parameters must be constant without variation.( V\_Sync\_Width, V\_Front\_Porch and V\_Back\_Porch must be constant on each video field ).

**Note6 :** The DE timings also must be constant without variation( H/V timing requirements are as same as previous. Blank timing must also be constant ).

### 6.4.2 Timing Diagram

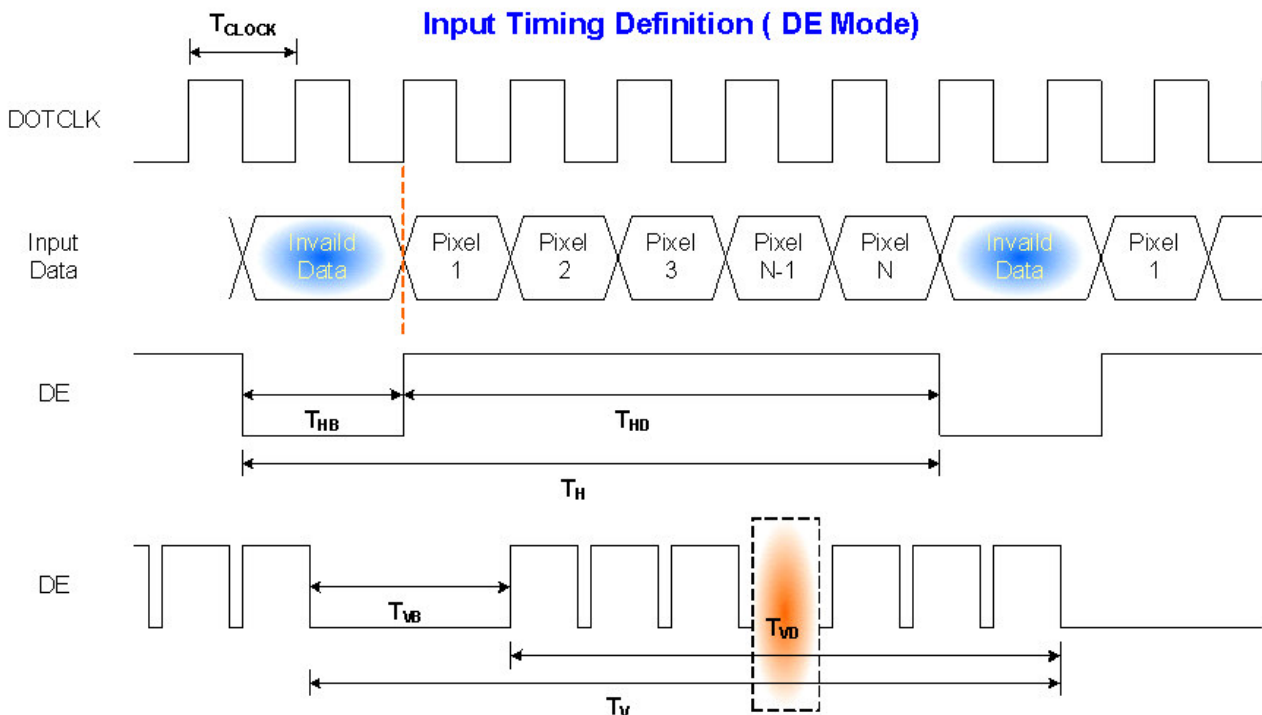



## 6.5 Power ON/OFF Sequence

VDD power and LED on/off sequence is as below. Interface signals are also shown in the chart. Signals from any system shall be Hi-Z state or low level when VDD is off.

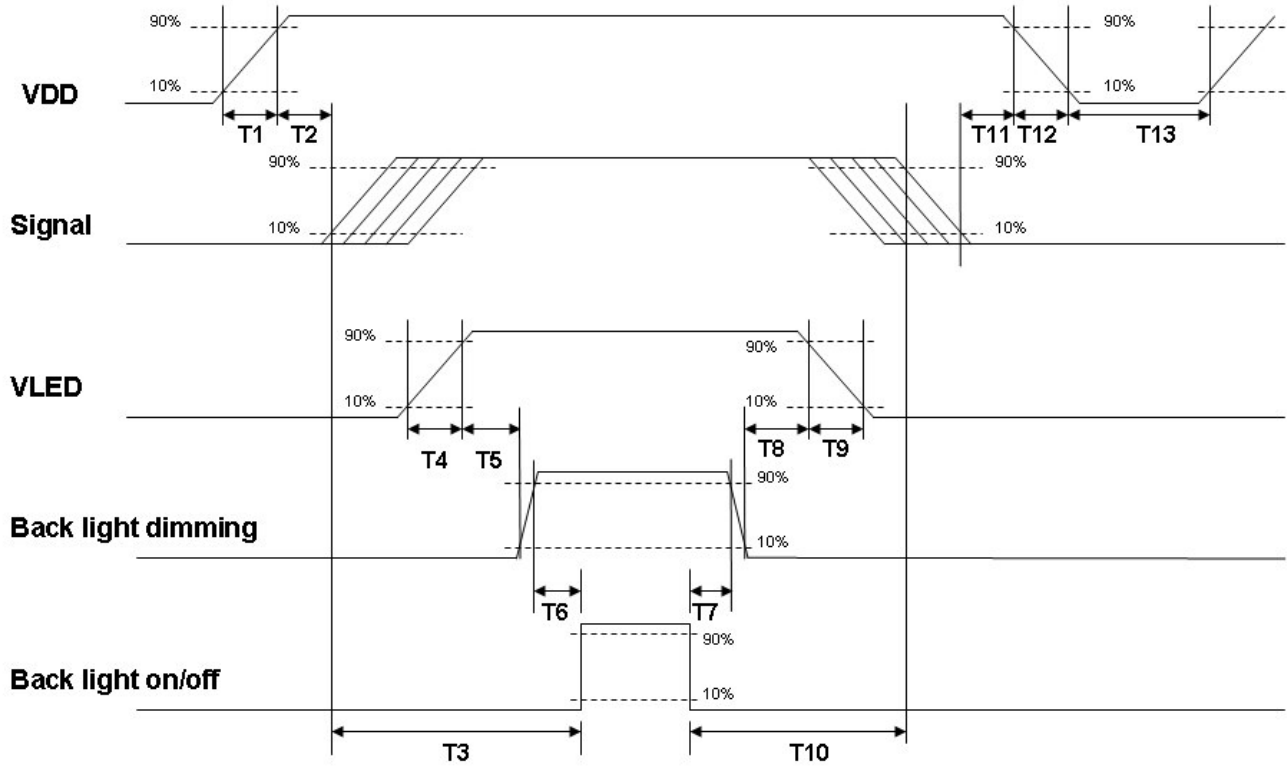

**Power ON/OFF sequence timing**

Parameter	Value			Units
	Min.	Typ.	Max.	
T1	0.1	-	10	[ms]
T2	200	-	-	[ms]
T3	50	-	-	[ms]
T4	0.5	-	10	[ms]
T5	10	-	-	[ms]
T6	10	-	-	[ms]
T7	10	-	-	[ms]
T8	10	-	-	[ms]
T9	0.5	-	10	[ms]
T10	50	-	-	[ms]
T11	10	-	-	[ms]
T12	-	-	10	[ms]
T13	1000	-	-	[ms]

The above on/off sequence should be applied to avoid abnormal function in the display. Please make sure to turn off the power when you plug the cable into the input connector or pull the cable out of the connector.

## 6.5 Power ON/OFF Sequence

VDD power and LED on/off sequence is as below. Interface signals are also shown in the chart. Signals from any system shall be Hi-Z state or low level when VDD is off.

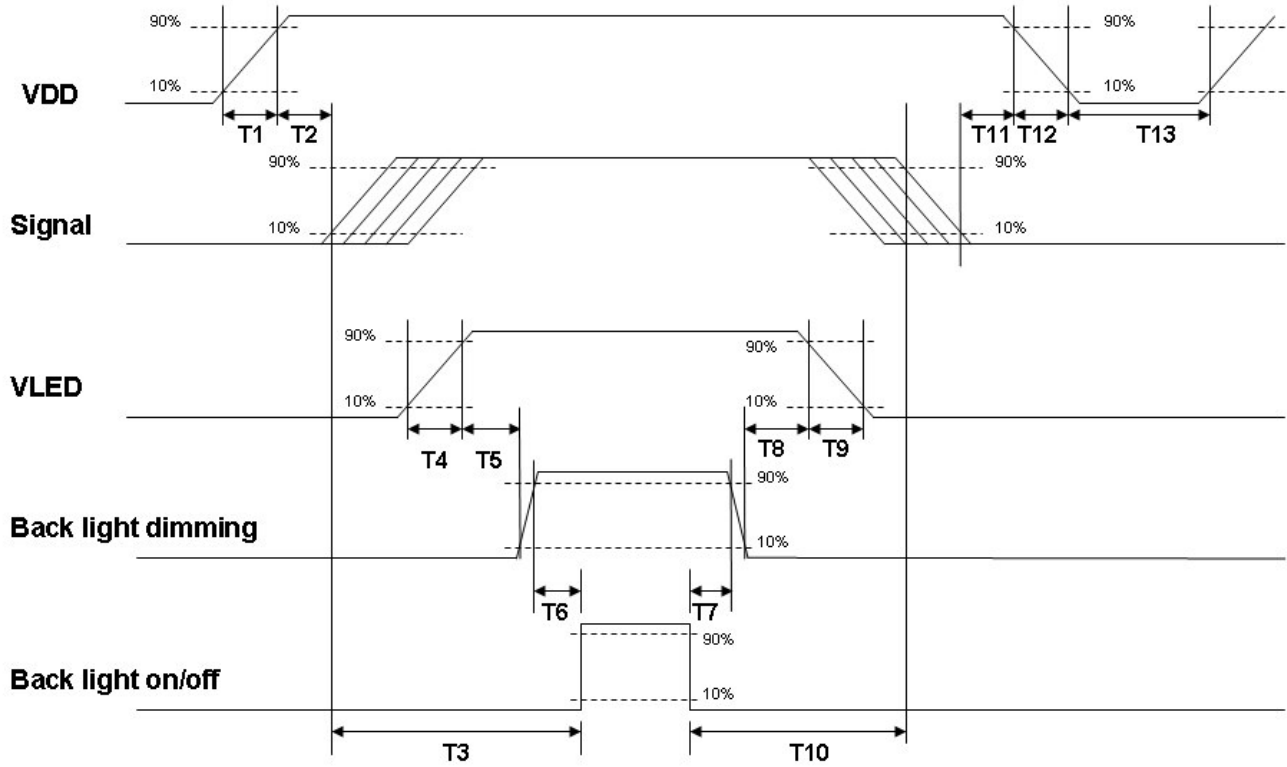

**Power ON/OFF sequence timing**

Parameter	Value			Units
	Min.	Typ.	Max.	
T1	0.1	-	10	[ms]
T2	200	-	-	[ms]
T3	50	-	-	[ms]
T4	0.5	-	10	[ms]
T5	10	-	-	[ms]
T6	10	-	-	[ms]
T7	10	-	-	[ms]
T8	10	-	-	[ms]
T9	0.5	-	10	[ms]
T10	50	-	-	[ms]
T11	10	-	-	[ms]
T12	-	-	10	[ms]
T13	1000	-	-	[ms]

The above on/off sequence should be applied to avoid abnormal function in the display. Please make sure to turn off the power when you plug the cable into the input connector or pull the cable out of the connector.

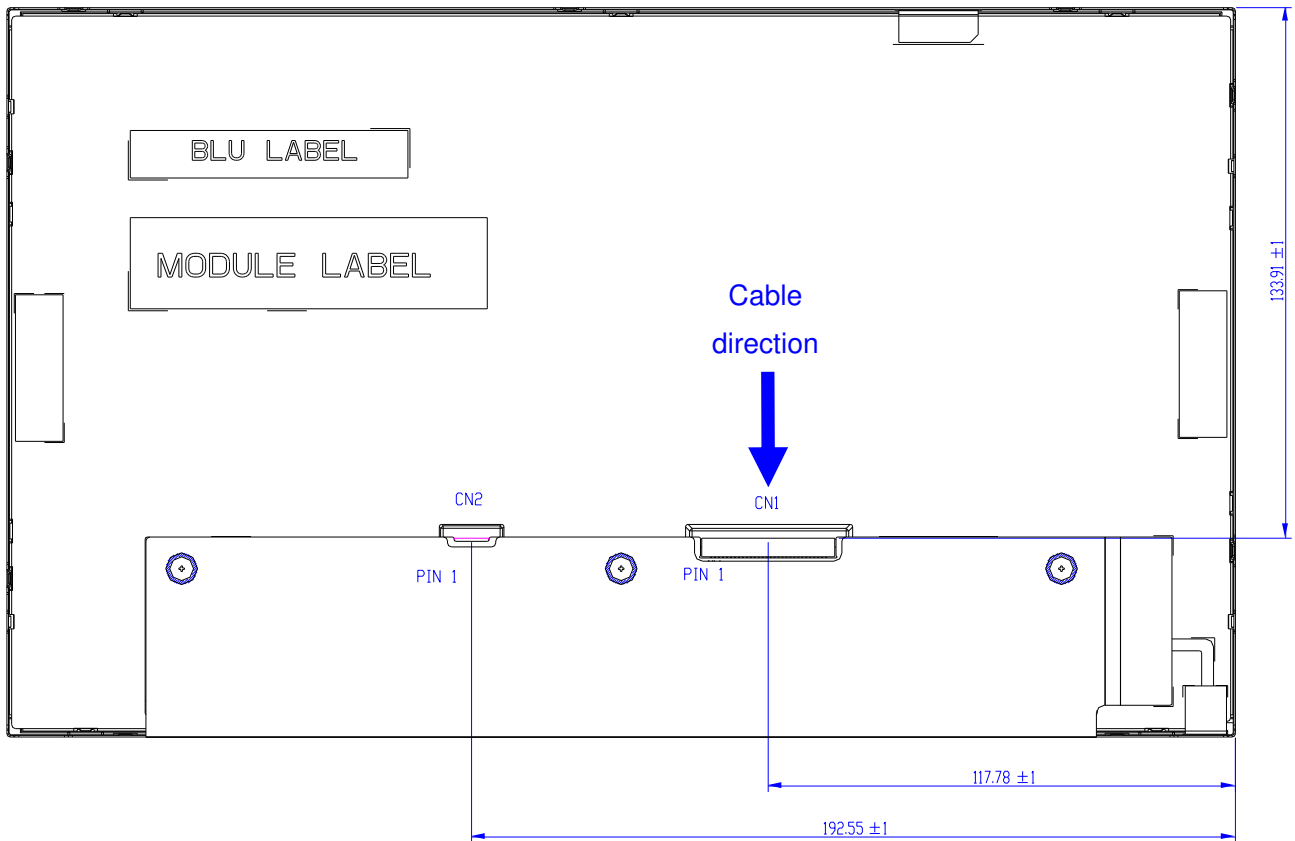

## 7.2 Backlight Unit

Physical interface is described as for the connector on module. These connectors are capable of accommodating the following signals and will be following components.

### 7.2.1 Connector (CN2)

Connector Name / Designation	LED Connector
Manufacturer	Hirose
Type Part Number	DF19G-8P-1H(54)
Mating Housing Part Number	DF19G-8S-1C(05) DF19A-2830SCFA(41)

### 7.2.2 LED Driver Connector Pin Assignment (CN2)

Pin#	Symbol	Signal Name
1	LED_EN	LED enable pin
2	LED_PWM	System PWM Single Input
3	NC	No connect
4	VLED	+12V
5	VLED	+12V
6	NC	No connect
7	GND	Ground
8	GND	Ground

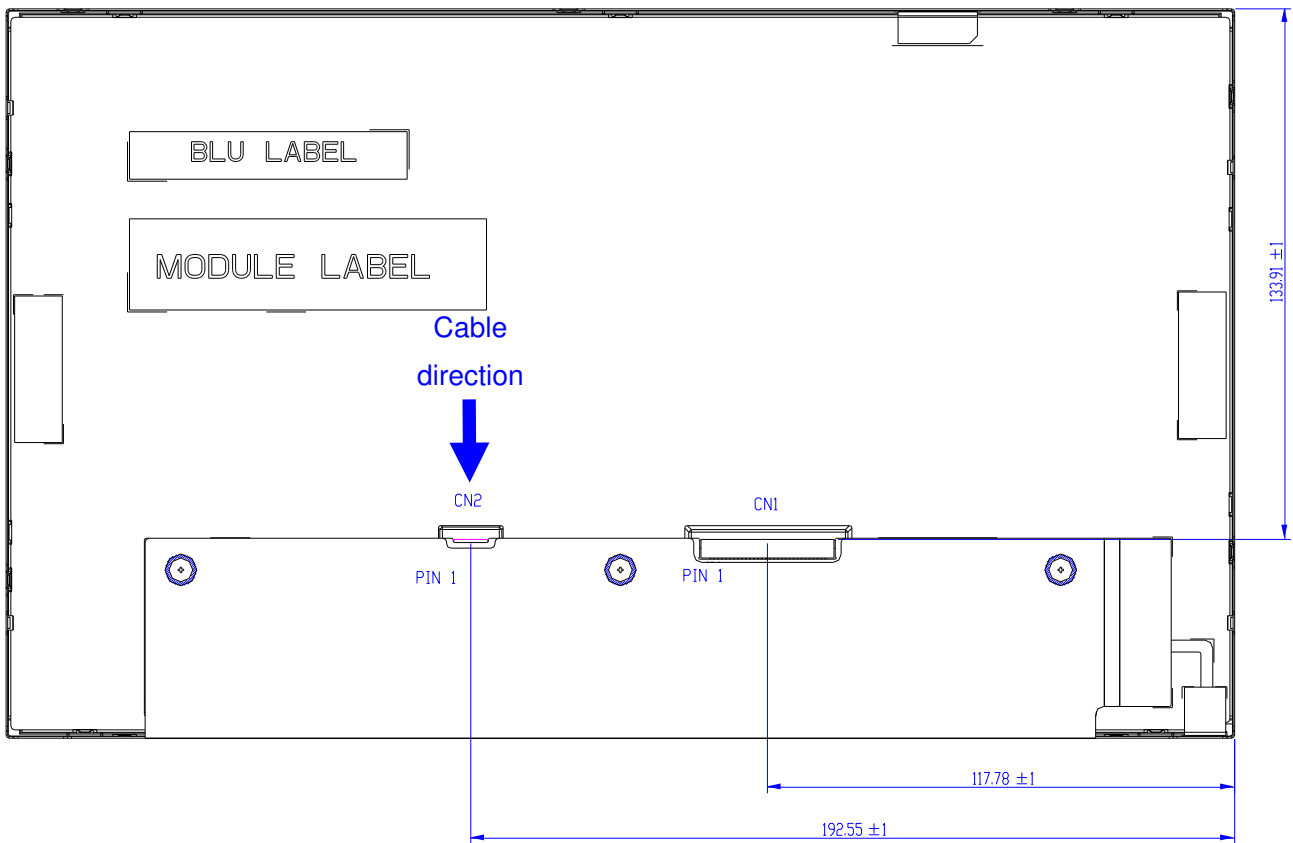



## 8. Panel Reliability Test

Items	Required Condition	Note
Temperature Humidity Bias	Ta= 40°C, 90%RH, 300h	Note 1,2
High Temperature Operation	Ta= 70°C , Dry, 300h	
Low Temperature Operation	Ta=-20°C, 300h	
High Temperature Storage	Ta= 70°C, Dry, 300h	
Low Temperature Storage	Ta= -20°C, 300h	
Thermal Shock Test	Ta=-20°C to 60°C, Duration at 30 min, 50 cycles	
Vibration test(non-operation)	1.5G, (10~200Hz~10, random), 30 mins/axis (X, Y, Z)	Note 1,2
Shock Test(non-operation)	50G,20ms,Half-sine wave,( ±X, ±Y, ±Z)	
ESD	Contact Discharge: ±8 KV, 150pF(330Ω) 1sec, 8Points, 25times/point Air Discharge: ±15 KV, 150pF(330Ω) 1sec, 8Points, 25times/point	Note 1

**Note 1:** According to EN 61000-4-2 , ESD class B: Some performance degradation allowed.  
Self-recoverable. No data lost, No hardware failures.

**Note 2:**

- Water condensation is not allowed for each test items.
- Each test is done by new TFT-LCD module. Don't use the same TFT-LCD module repeatedly for reliability test.
- The reliability test is performed only to examine the TFT-LCD module capability.
- To inspect TFT-LCD module after reliability test, please store it at room temperature and room humidity for 24 hours at least in advance.
- No function failure occurs. Mura shall be ignored after high temperature reliability test





# Product Specification

AU OPTRONICS CORPORATION

## 10 .Mechanical Characteristics

### 10.1 LCM Outline Dimension (Front View)

- NOTES:  
1. CN1: LVDS INTERFACE CONNECTOR TO BE HRS DF19K-30P-1H(54)  
2. CN2: LED DRIVER CONNECTOR TO BE HRS DF19G-8P-1H(54)  
3. USER HOLE MAXIMUM INSERTION DEPTH IS 2.5mm.  
4. UNSPECIFIED TOLERANCE TO BE  $\pm 0.5\text{mm}$ .

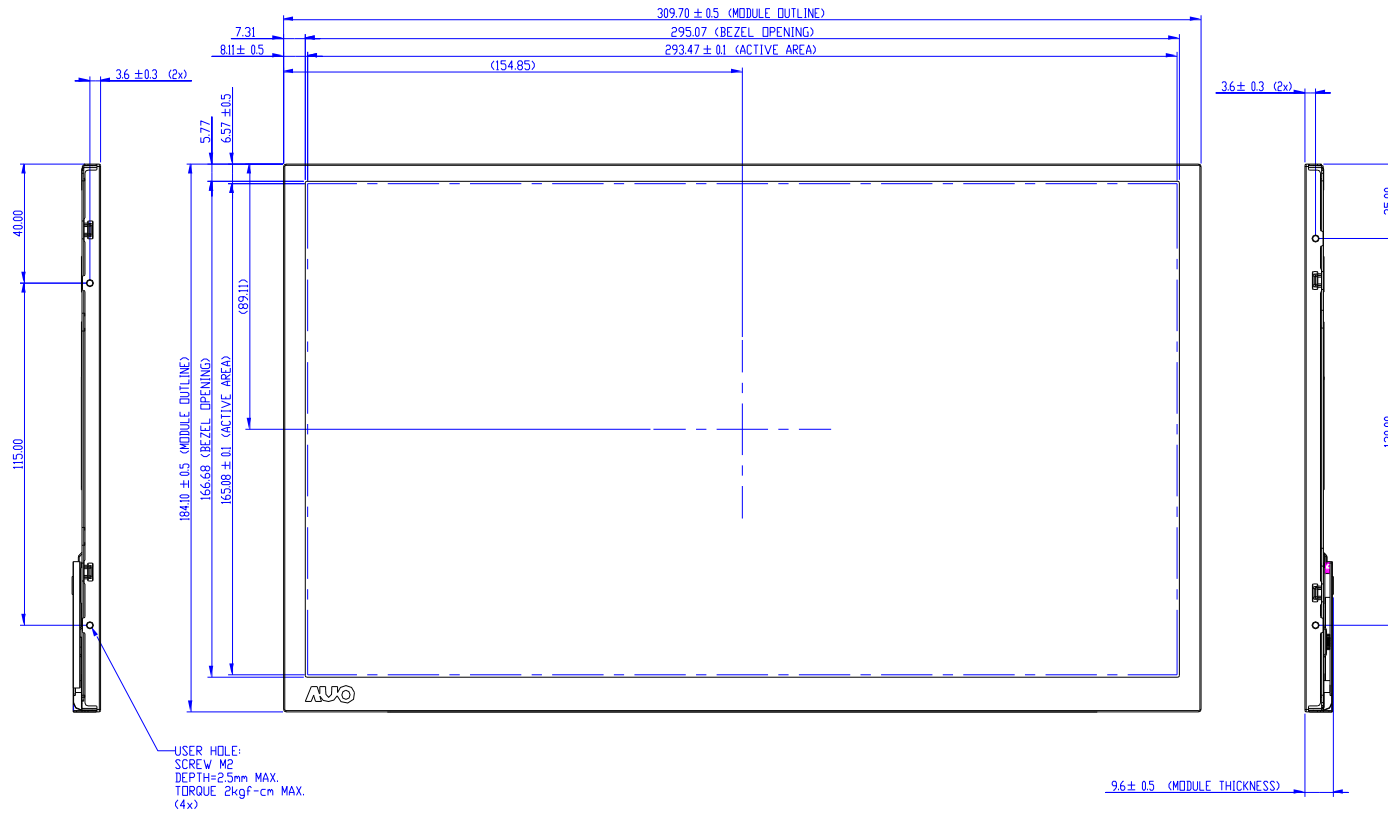



# Product Specification

AU OPTRONICS CORPORATION

## 10.2 LCM Outline Dimension (Rear View)

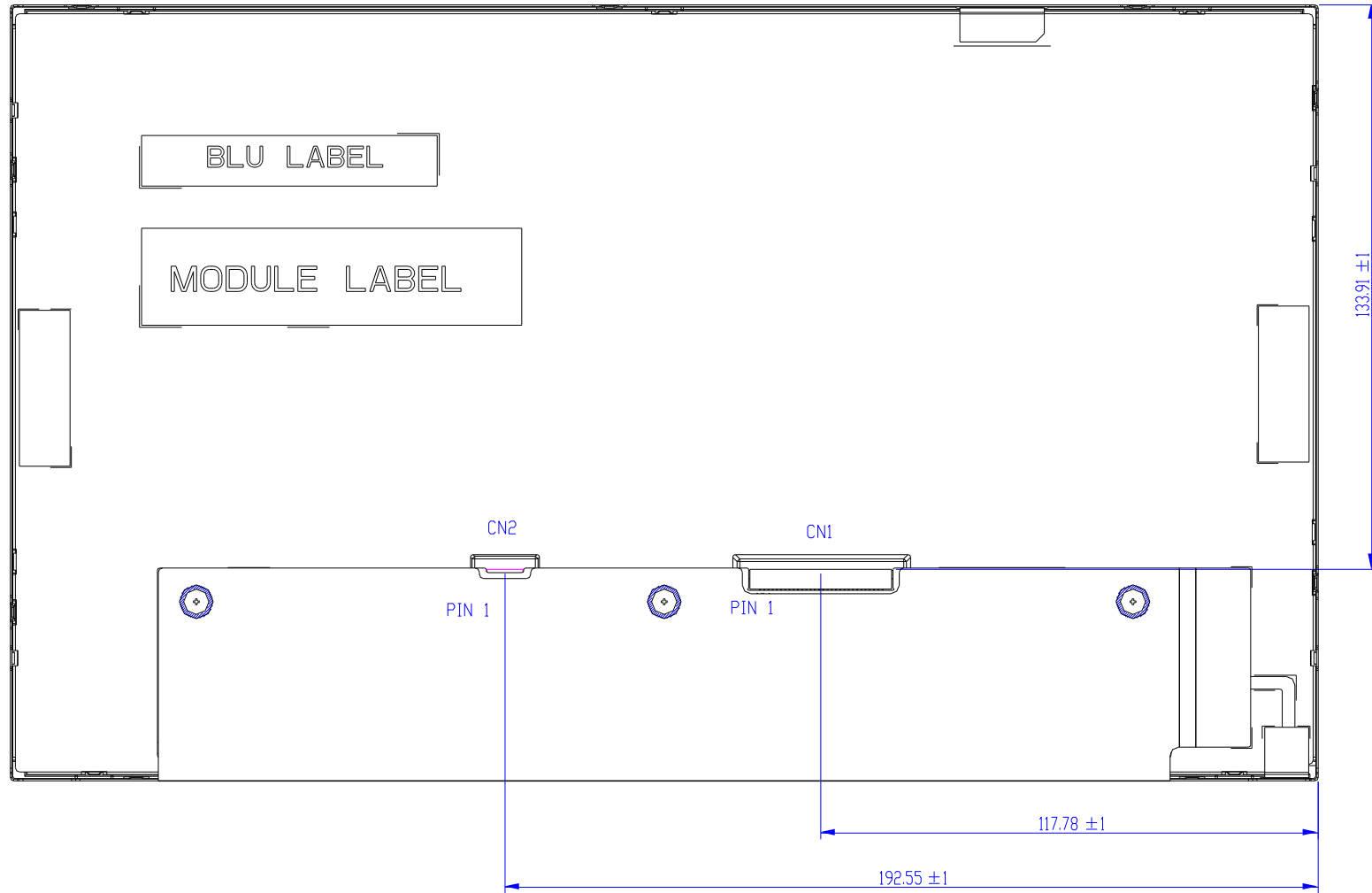





**13.3" PCAP Solution  
12029459**

Date: 2/11/2019

## Table of contents

<b>1</b>	<b>Scope .....</b>	<b>3</b>
<b>2</b>	<b>Touch Sensor and Cover Glass .....</b>	<b>3</b>
2.1	Technical Parameters.....	3
2.2	Reliability Tests.....	4
<b>3</b>	<b>Recommended Touch Controller.....</b>	<b>4</b>
<b>4</b>	<b>Optical Inspection Criteria and Handling Recommendations .....</b>	<b>4</b>
4.1	Optical Inspection Criteria.....	4
4.2	Handling Recommendations .....	4
<b>5</b>	<b>Appendix A: Technical Drawing .....</b>	<b>5</b>
<b>6</b>	<b>Revision History .....</b>	<b>6</b>

## 1 Scope

DATA MODUL's PCAP solution 12029459 consists of a 13.3" capacitive touch screen. Please note that this is only a sub-assembly of the final product. The specification of the final end product might differ from this specification.

## 2 Touch Sensor and Cover Glass

### 2.1 Technical Parameters

Screen size	13.3 inch /33 cm
Format	Wide
Composite	SITO with Tail
Outline dimensions	303.3 x 177.0 x 1.1 mm (WxHxT)
Active area	295.07 x 166.68 mm (WxH)
Bending radius of tail	R = 2 mm recommended
Transmissivity	86% (min.)
Operating temperature and humidity	-30 to +85
Storage temperature and humidity	-40 to +85
Tail connector	Hirose FH28H-80S-0.5SH, Hirose FH28H-50S-0.5SH

## 2.2 Reliability Tests

Low Temperature Storage Test	-30 °C for 120 h, 1h recovery at room temperature
High Temperature Storage Test	70 °C for 120 h, 1h recovery at room temperature
High Temperature / High Humidity Test	60°C, 90% RH for 120h, 1h recovery at room temperature
Cycle test	-30°C / 80°C, 30 min / cycle, 100 cycles, 1 h recovery at room temperature

## 3 Recommended Touch Controller

The recommendation for this PCAP solution is a controller based on mXT2952T2. Please ask your local DATA MODUL sales representative for further details.

## 4 Optical Inspection Criteria and Handling Recommendations

### 4.1 Optical Inspection Criteria

For details on the optical inspection criteria, please refer to DATA MODULs Outgoing Spec or ask your local DATA MODUL sales representative.

### 4.2 Handling Recommendations

Precautions for operation

- Do not put a heavy, hard or sharp object on the product
- Do not bend the product in order to assure the reliability
- Do not put one product on the other. Otherwise, it may cause the product to be scratched
- Don't use any organic solvent acid or alkali solution.

Precautions for mounting

- The panel should be mounted using a configuration that either holds the panel by all four corners or by all four sides
- The bezel edge must be positioned outside the active area. The bezel may cause false activation if the edge overlaps the active area
- Any mounting configuration should ensure that there is no twisting force applied to the panel
- 1mm distance between TFT screen and touch panel is recommended

Precautions for tail

- The flex tail in general can be bent with a min. radius of about 1mm
- In order to avoid damaging and malfunction of the sensor, please don't bend the FPC area next to the panel
- Excess or repeated bending of the FPC connector should also be avoided

## 5 Appendix A: Technical Drawing

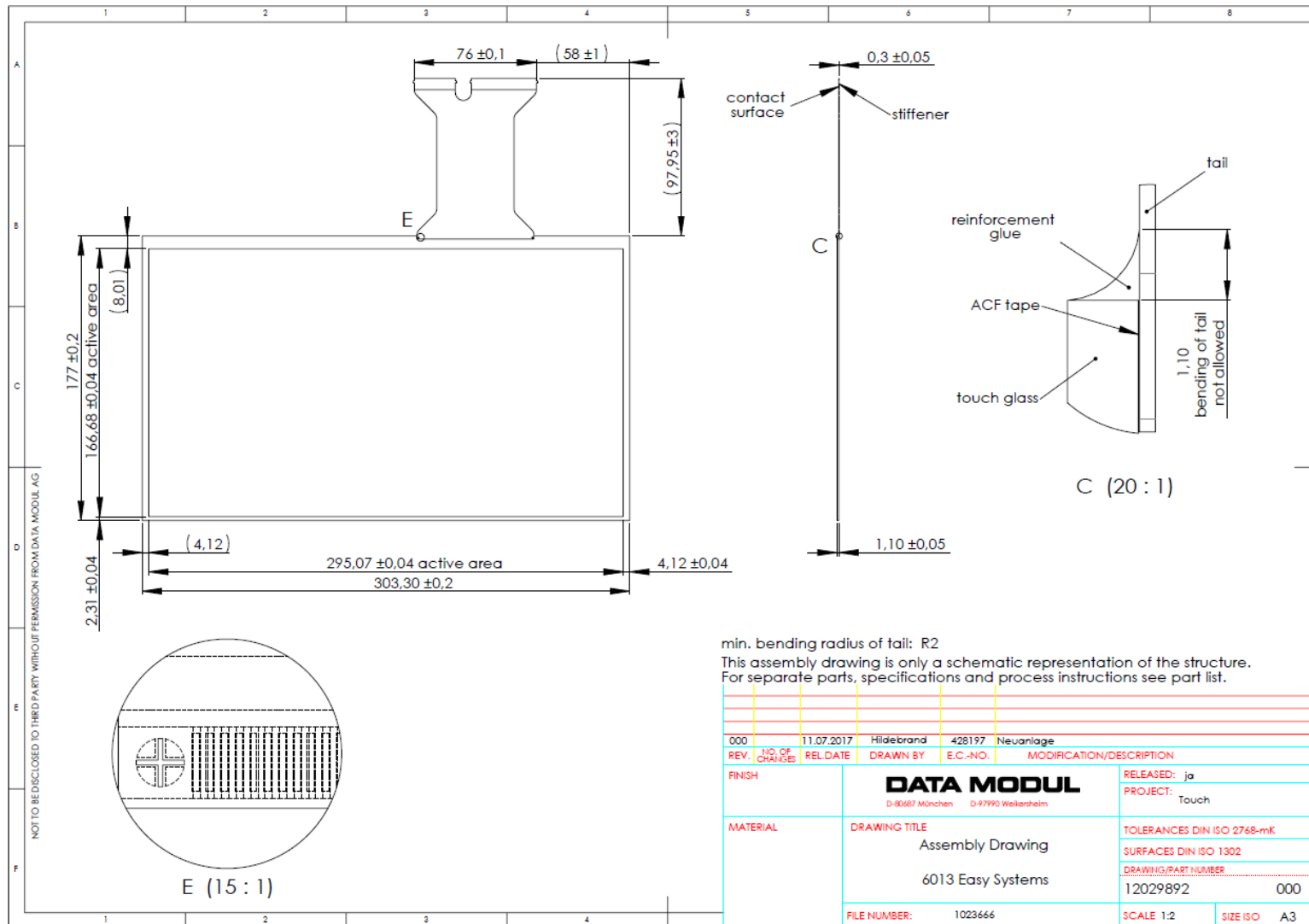

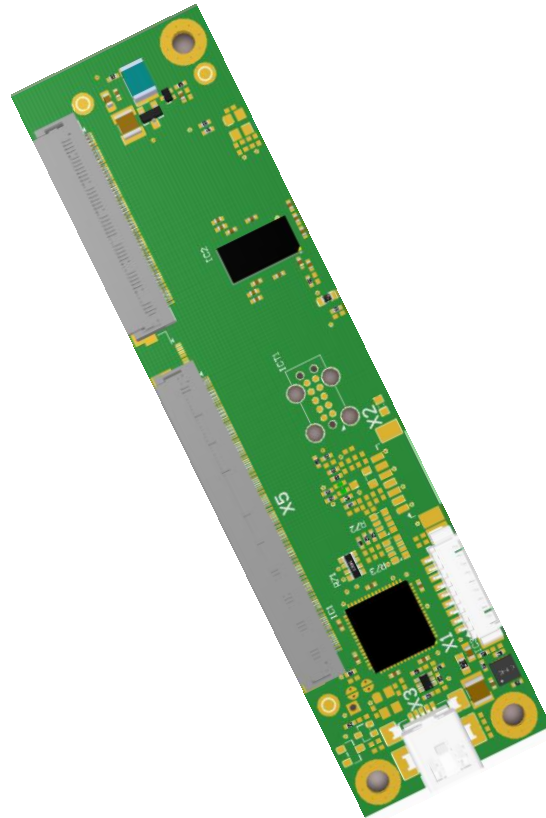

## **easyTOUCH mXT2952T2 2-tail PCAP USB controller**

Revision: 003

Date: 2016-03-29

## Table of contents

<b>1</b>	<b>Introduction</b> .....	<b>3</b>
<b>2</b>	<b>Controller specification</b> .....	<b>4</b>
2.1	Mechanical features .....	4
2.2	Connection features.....	4
2.3	Electrical features .....	4
<b>3</b>	<b>Mechanical drawing</b> .....	<b>5</b>
<b>4</b>	<b>Connectors and signals</b> .....	<b>6</b>
4.1	Connectors .....	6
4.2	X1 pin assignment.....	6
<b>5</b>	<b>UL information</b> .....	<b>7</b>
<b>7</b>	<b>Appendix: Frequently asked questions</b> .....	<b>8</b>

# 1 Introduction

The easyTouch mXT2952T2 Controller is designed as a part of the capacitive touch systems developed by Data Modul. It offers the possibility to connect a projective capacitive touch sensor to standard computers or embedded systems using USB.

The controller is based on the Atmel maXTouch 2952T2 which offers a very good touch performance and high noise resistance. To get the best touch performance with water and glove usage the mXT2952T2 has integrated self-capacitance technology. In combination with the mutual-capacitance entity the controller is applicable for single- and multi-touch. Together with outstanding filter technology the maXTouch ICs are suitable for industrial, medical and other applications.

For the communication with the OS the controller uses Data Modul's Driverless firmware. The firmware connects as a Human Interface Device (HID) without an additional driver to the most popular operating systems like Windows XP, Windows 7 / 8, Windows CE5/6/7, OSX and Linux. For more information about the Data Modul Driverless firmware please refer to the *Driverless Controller User Guide*.



## 2 Controller specification

### 2.1 Mechanical features

---

Size	105x27x6 mm
Operating temperature	-40 to +85 °C
Storage temperature	-40 to +85 °C
Temperature slew rate	10 °C /minute (max.)
Relative humidity	95 % at 60 °C no condensation
RoHS compliant	Yes

---

### 2.2 Connection features

---

Protocol	HID mouse, HID digitizer
Multi touch	16 fingers (max.)
Single touch	HID mouse with right mouse button emulation
Resolution	4096 x 4096 (x/y)
Report rate	>100 Hz for 15 touches, subject to configuration
USB connector	Mini USB or Molex 53261-0971

---

### 2.3 Electrical features

---

Power supply	5 V± 5%
Vin ripple	±50 mV peak-peak (max.)
On board voltage	3.3 V and 8.5 V
Power consumption	500 mW (max. subject to configuration)

---

### 3 Mechanical drawing

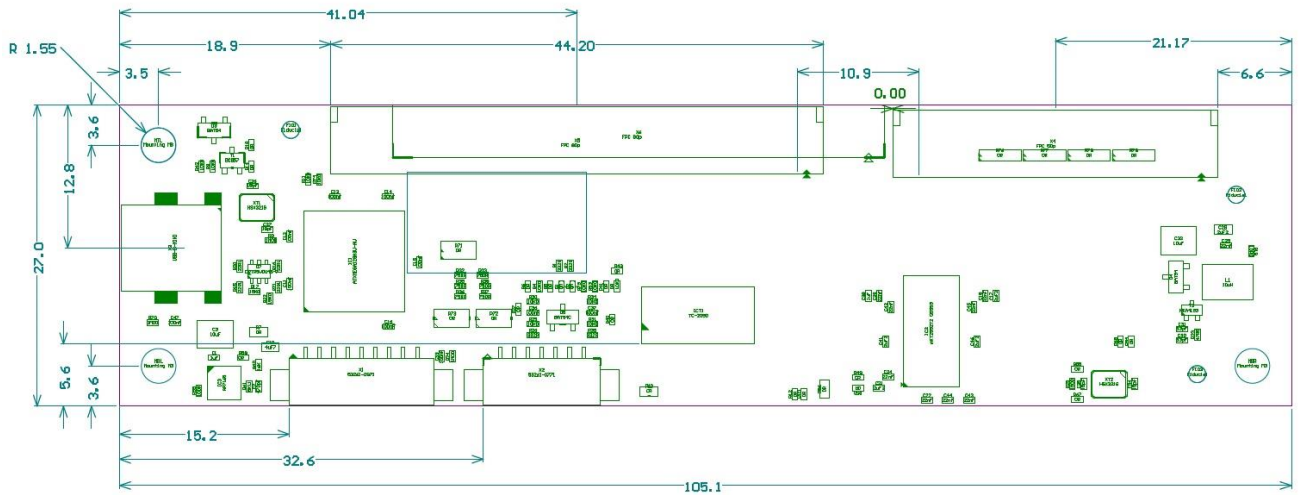

Height: 6 mm (including components)

## 4 Connectors and signals

### 4.1 Connectors

Connector	Type	Connection
X1	1.25 mm Pitch 9 pin header Molex 53261-0971 compatible	USB
X3	Mini USB connector	USB
X4	0.5 mm pitch 50 pin header	Flextail to touch sensor
X5	0.5 mm pitch 80 pin header	Flextail to touch sensor

### 4.2 X1 pin assignment

X1	Signal	Description
1	VDD_5V	USB power supply
2	USB DM	USB signal -
3	USB DP	USB signal +
4		Do not use
5		Do not use
6		Do not use
7		Do not use
8		Do not use
9	GND	Ground

Matching USB cable (length 2m): Article number **TP72241**

## 5 UL information

Part	Type	UL number
X1	1.25 mm pitch 9 pin header MOLEX 53261-0971 compatible	Molex 53261-xx71: E29179 or YeonHo 12505WR-xx: E108706
X3	Mini USB connector	FCI 10033526-N3212LF or W+P 8233-2-05-60-FTR/SW: Thermoplastic UL94V-0
X4	0.5 mm pitch 50 pin header	Hirose FH28D-xxS-0.5SH(05): LCP resin (UL94V-0)/gray LCP resin (UL94V-0)/black
X5	0.5 mm pitch 80 pin header	Hirose FH28H-xxS-0.5SH(05): LCP resin (UL94V-0)/gray LCP resin (UL94V-0)/black
PCB		Fastprint: E204460

## 7 Appendix: Frequently asked questions

### Touch coordinates are not stable and the cursor is “jumping around”?

In mains-operated systems this can happen if the touch controller is missing the systems ground reference. Another reason can be an extreme amount of noise present that exceeds the touch threshold set in the controller.

Please connect the system ground reference to one of the mounting holes. For best touch performance the touch controller needs a low impedance AC connection to the person that operates the system to achieve a good current loop back to the controller.

If the instability is caused by a noise source like a display, a switching regulator or a RF antenna your system may have an integration issue. With proper settings the controller can most likely suppress the noise. However, eliminating the noise source should be the first thing to check. If you have any difficulties to find the correct settings, please contact Data Modul.

# eMotionST1:3



## Final Specification

### Hardware Revision 05

This document might be changed without prior notice

Revision	1.3
Date	16.01.2015
Name	M. Schmidt

## Table of contents

1.	Revision History	4
2.	General Description	5
3.	Features	5
4.	Electrical Specification of inputs and outputs	6
4.1	Power Supply voltage	6
4.2	Panel supply voltage	6
4.3	LVDS	6
4.4	Backlight	6
4.5	DVI input	7
4.6	DisplayPort Input	7
4.7	VGA input	7
5.	Qualifications	8
5.1	Environmental conditions	8
5.2	EMI Standards	8
5.3	Safety	8
5.4	Shock and Vibration	8
6.	Outline dimensions	9
7.	Overview of Connectors and Jumpers	10
7.1	Power Input Connector	11
7.2	VGA Input Connector	11
7.3	DVI Input Connector	12
7.4	Display Port Input Connector	12
7.5	LVDS Output	13
7.6	Inverter / Backlight	13
7.7	OSD Connector	14
7.8	GPIO Connector	14
7.9	Systembus	14
7.10	RS232 Connector	14
7.11	Fan Connector	15
7.12	Inverter Switch	15
8.	Jumper settings and configuration	16

8.1.	Panel supply voltage (CN200)	16
8.2.	Backlight Power Supply (CN202, CN203, CN204)	16
8.3.	Backlight Dimming (CN600)	16
8.4.	Backlight Enable Signal (CN601, CN602)	16
8.5.	Panel file configuration	17
<b>9.</b>	<b>OSD (On Screen Display)</b>	<b>17</b>
9.1.	Mechanical dimensions OSD board (CU70008, incl. input cable)	17
9.2.	Operation & buttons	18
9.3.	Hotkeys	18
9.4.	OSD Status LED	18
9.5.	OSD Structure	19
9.5.1	Picture Menu	20
9.5.2	VGA Settings Menu	20
9.5.3	Setup Menu	20
9.5.4	Color Menu	20
9.5.5	User Color Menu	21
9.5.6	Inputs Menu	21
9.5.7	OSD Menu	21
9.5.8	OSD Position Menu	21
9.5.9	Info Menu	22
9.5.10	Advanced Setup Menu	22
<b>10.</b>	<b>Serial Control RS232</b>	<b>22</b>
<b>11.</b>	<b>DDC/CI Interface</b>	<b>22</b>



## 1. Revision History

Rev.	Date	Chapter	Description	by
1.0	24.03.2012	All	First draft	MS
1.1	30.07.2012	All	Cosmetic changes	MS
1.2	04.04.2014	9.4 OSD Status LED 9.5 OSD Structure	LED state power off changed Color menu changed	MS
1.3	15.01.2015	7. Overview of connectors and jumpers	CN104 connector family corrected	MS

## 2. General Description

The eMotionST1:3 is an advanced TFT-LCD controller board to connect LCDs standard VGA, DVI, and DisplayPort sources. All necessary timings and voltages to support the connected display and backlight are generated on the eMotionST1:3.

## 3. Features

<b>Scaler</b>	STMicroelectronics STDP6036
<b>Input resolution</b>	Up to WUXGA (1920x1200@60Hz)
<b>Output resolution</b>	VGA up to WUXGA
<b>Colors</b>	16.7M
<b>Power Supply</b>	Single power supply +12V / +24V DC
<b>Operating temperature</b>	0 ...60 °C
<b>Inputs</b>	VGA, DVI, DisplayPort 1.1a
<b>Panel voltage</b>	3.3V, 5.0V, 12.0V (selectable with jumpers)
<b>LVDS output</b>	JEIDA or VESA mapping selectable by panel file
<b>Backlight support</b>	Analog & PWM dimming
<b>Power safe mode</b>	VESA DPMS compatible
<b>DDC CI</b>	Support of DDC / CI
<b>Remote Control</b>	RS232 remote control
<b>Software update</b>	- RS232 - Smart ISP - VGA-input using VGA to DDC adapter

## 4. Electrical Specification of inputs and outputs

### 4.1 Power Supply voltage

The eMotionST1:3 can handle 12V or 24V DC input voltage. The board is designed for a single power supply. All other supply voltages are generated on the eMotionST1:3. If the input supply voltage is used for backlight supply (jumper CN202, CN203, CN204 position 2-3) then the input voltage of the board must fit with the backlight supply voltage.

An additional SMPS on the eMotionST1:3 is used to generate +12V supply voltage for the backlight inverter. Therefore the jumper CN202, CN203 and CN204 have to be placed in position 1-2. In this position the max. backlight current is limited to 3A.

Supply voltage	Nominal value	Regulation	Ripple & noise	Comment
+12V	+12.0V	+/-10%	0.3V	
+24V	+24.0V	+/-10%	0.3V	

### 4.2 Panel supply voltage

The panel supply voltage is generated on the eMotionST1:3. The eMotionST1:3 can generate 3.3V, 5.0V or 12.0V panel supply voltage. The max current is limited to 3.0A. Select the panel supply voltage with jumper CN200.

Note: 12.0V panel supply can only be used if the supply voltage of the board is 24V.

Panel supply voltage	Nominal value	Regulation	max Current	Comment
+ 3.3V	+3.3V	+/-5%	3.0 A	CN200 Pin 1-2 closed
+ 5.0V	+5.0V	+/-5%	3.0 A	CN200 PIN 3-4 closed
+12.0V	+12.0V	+/-5%	3.0 A	CN200 PIN 5-6 closed

### 4.3 LVDS

PARAMETER	MIN	TYP	MAX	UNIT	Remark
Differential Output Voltage	300	500	700	mV	
Common Mode Voltage		1.25		V	
Clock Frequency			100 90	MHz	Single Channel Dual Channel
Bits per Color	6		8	bit	6/8bit selectable in panel file

### 4.4 Backlight

The backlight supply voltage can be selected by the jumper CN202, CN203, CN204. All three jumpers must be set in the same position.

In position 2-3 the backlight supply voltage is equal the input voltage of the board. The max. backlight current is limited to 6A.

In position 1-2 the backlight supply voltage is generated by a 12V SMPS on the board (do only use it with 24V board supply voltage). Using this configuration, the max. backlight current is limited to 3A.

Signal	Description
V dimm A	Analog dimming voltage 0 to 5.0V / 0 to 3.3V selectable with jumper CN600
V dimm PWM	3,3V / 5.0V level selectable with jumper CN600
Enable	3,3V / 5,0V level selectable with jumper CN601, polarity selectable with jumper CN602
VDD	Operating voltage of the backlight. Jumper CN202-204 in position 2-3: The backlight voltage is the same as board supply

	voltage Max current is limited to 6A. <b>Jumper CN202-204 in position 1-2:</b> The backlight voltage is set to +12V. Use it only with +24V board supply voltage. The max backlight current is limited to 3A.
--	--

#### 4.5 DVI input

TMDS receiver compliant with DDWG DVI 1.0 specification

PARAMETER	MIN	TYP	MAX	UNIT	Remark
Differential Input Voltage	150		1200	mV	
Input Common Mode Voltage	-300		-37	mV	
Input Clockfrequency	20		165	MHz	

#### 4.6 DisplayPort Input

DisplayPort 1.1a compliant receiver. 4-lane DisplayPort input

PARAMETER	MIN	TYP	MAX	UNIT	Remark
Peak-to-peak input differential voltage	0.12		1.4	V <sub>pp</sub>	
Rx DC Common Mode Voltage	0		V <sub>DD</sub>	V	
R <sub>t</sub> Termination Resistance	45	50	55	Ω	

#### 4.7 VGA input

PARAMETER	MIN	TYP	MAX	UNIT	Remark
Conversion rate	10		205	MHz	
ADC resolution	8		10	bit	Up to 165MHz sample rate 10 bits per color are used, up to 205MHz sample rate 8 bits per color are used
Input levelrange	0,64	0,7	0,9	V <sub>pp</sub>	at 75R
Band width	9		290	MHz	
SOG level		0,3		V	at 75R

## 5. Qualifications

### 5.1 Environmental conditions

Parameter	Min	Max
Operating Temperature	0°C	+60°C
Storage Temperature	-20°C	+80°C
Relative humidity		80%
Tolerable air-pressure	708 hPa (approx. Altitude 2000m)	

### 5.2 EMI Standards

		Criteria
EMI/EMC:	EN55022-B (appendix A1:2007 from Oct., 1 <sup>st</sup> 2011 on), highest internal frequency on the board is below 400MHz (DDR data lines).	D
ESD:	EN61000-4-2 contact discharge 4kV EN61000-4-2 air discharge 8kV	B
Radiated RF (80-1000MHz):	EN61000-4-3 (20V/m 80% modulation level from 80 – 1000MHz)	A
Conducted disturbances induced by RF fields:	EN61000-4-6 (10Veff, AM 80%, 1kHz from 150kHz – 80MHz)	A
Radiated RF:	EN50204:1995; 900MHz, 20V/m, pulse 50%	A

Note: To ensure that the board meets the standard mentioned above, an adequate shielding cover must be added. Alternatively the housing of the monitor must act as shielding cover (e.g. aluminium enclosure).

### 5.3 Safety

- EN60950-1: Latest edition
- Designed to meet UL60950-1

### 5.4 Shock and Vibration

#### MECHANICAL STRESS

Shock:	20G, 11ms, half sine (x/y direction)
	15G, 11ms, half sine (z direction)
Vibration:	1.2G, 10 – 55Hz, sinus
Sweep:	1 minute/octave
Amplitude:	0.35mmp-p (x-direction)
	0.35mmp-p (y direction)
	0.175mmp-p (z-direction)
Time :	30 minutes
Standard:	Conform to EN60605

## 6. Outline dimensions

Dimensions: 150mm (L) x 110 mm (W) x 17mm (H)

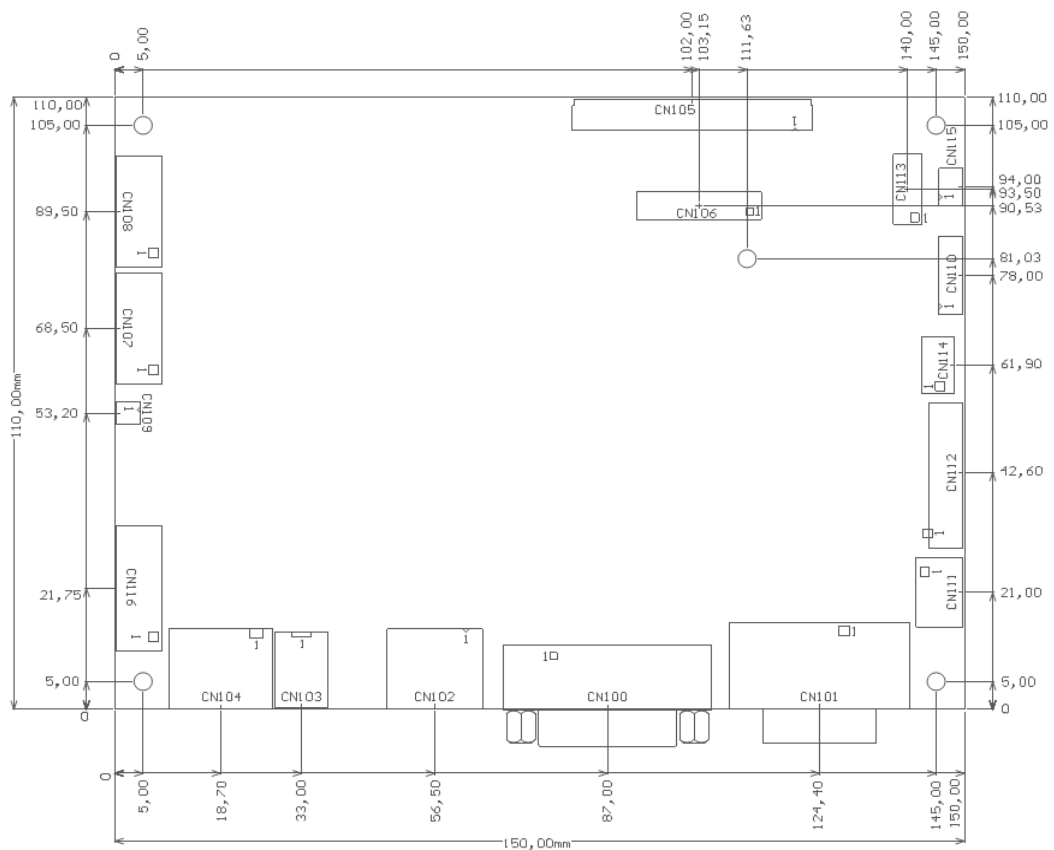
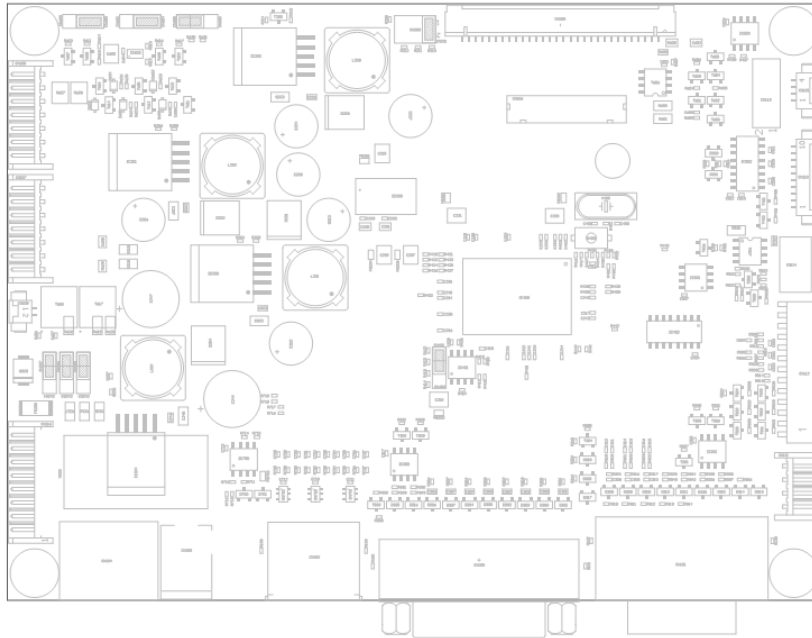

## 7. Overview of Connectors and Jumpers

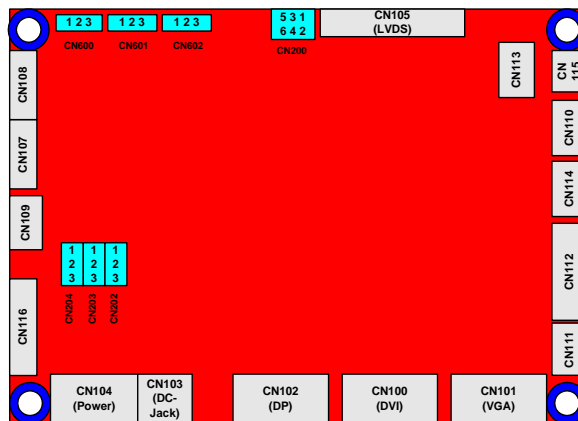
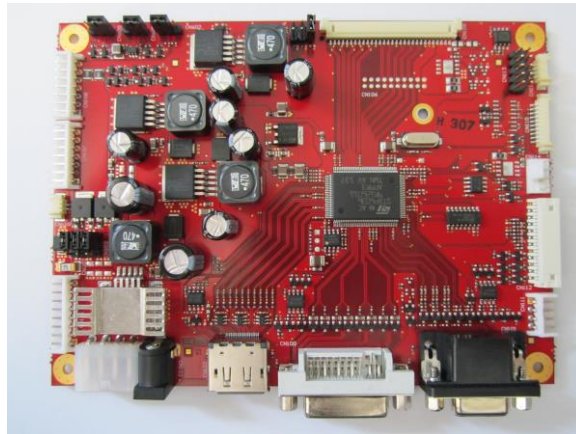

Item	Description	Remarks
CN103	Power	DC-Jack 2.5mm
CN104	Power	Molex Series 5569
CN116	Power (internal)	JST S8B-EH
CN100	DVI input	24 pin DVI-D connector, female
CN101	VGA input	15 pin HD-Sub connector, female
CN102	DP input	DisplayPort connector
CN105	LVDS Dual link output	Hirose DF14-30P-1.25H
CN107	Backlight connector	JST S7B-EH
CN108	Backlight connector	JST S7B-EH
CN109	Inverter Switch	Inverter switch signal
CN110	GPIO connector	10pin multi functions connector
CN111	Systembus	JST S4B-EH
CN112	OSD	Molex 53015-1210
CN113	RS232	10 pin double row connector RS232 LVTTTL Signal
CN114	FAN	Fan connector
CN115	RS232	RS232 LVTTTL Signal (MOLEX 53261-0471)
CN200	Jumper Block for Panel VCC	6pin double row connector
CN202	Jumper block for Backlight supply voltage	6pin double row connector
CN203		Note: Same position must be set for all three jumpers.
CN204		
CN600	Backlight PWM voltage select	3pin row connector
CN601	Backlight EN voltage select	3pin row connector
CN602	Backlight EN polarity	3pin row connector

## 7.1 Power Input Connector

Connector: CN104 - MOLEX 0039303045

Pin No.	Signal	Description
1	GND	Ground
2	GND	Ground
3	+12V / +24V DC	VDD / max 4A per pin
4	+12V / +24V DC	VDD / max 4A per pin

Connector: J101 - 2.5mm DC Jack

Pin No.	Signal	Description
1	+12V / +24V DC	VDD / max 5A
2	GND	Ground

Connector: CN116 - JST S8B-EH

Pin No.	Signal	Description
1	GND	Ground
2	GND	Ground
3	GND	Ground
4	GND	Ground
5	+12V / +24V DC	VDD / max 3A per pin
6	+12V / +24V DC	VDD / max 3A per pin
7	+12V / +24V DC	VDD / max 3A per pin
8	+12V / +24V DC	VDD / max 3A per pin

## 7.2 VGA Input Connector

Connector: CN101 - 15pin HD-Sub, female

Pin No.	Signal	Description
1	Red	Red analog input
2	Green	Green analog input
3	Blue	Blue analog input
4	NC	Not connected (GND)
5	GND (Red)	Ground
6	GND (Green)	Ground
7	GND (Blue)	Ground
8	GND	Ground
9	VGA 5V	+5V DC
10	GND	Ground
11	NC	Not connected
12	SD	Serial Data Line for DDC
13	HSYNC	Horizontal Sync
14	VSNC	Vertical Sync
15	SCL	Serial clock input for DDC



### 7.3 DVI Input Connector

Connector: CN100 - DVI-D24P

Pin No.	Signal	Description
1	TMDS DATA2-	TMDS DATA2 Differential negative signal
2	TMDS DATA2+	TMDS DATA2 Differential positive signal
3	TMDS DATA2 Shield	Shield for TMDS channel 2
4	NC	Not connected
5	NC	Not connected
6	DDC Clock	Clock DDC Interface
7	DDC Data	Data DDC Interface
8	NC	Not connected
9	TMDS DATA1-	TMDS DATA1 Differential negative signal
10	TMDS DATA1+	TMDS DATA1 Differential positive signal
11	TMDS DATA1 Shield	Shield for TMDS channel 1
12	NC	Not connected
13	NC	Not connected
14	+5V Power	+5V for EDID (un-powered monitor)
15	GND (for +5V)	Ground
16	HPD	Hot Plug Detect
17	TMDS DATA0-	TMDS DATA0 Differential negative signal
18	TMDS DATA0+	TMDS DATA0 Differential positive signal
19	TMDS DATA0 Shield	Shield for TMDS channel 0
20	NC	Not connected
21	NC	Not connected
22	TMDS Clock Shield	Shield for TMDS clock
23	TMDS CLOCK+	TMDS Clock Differential positive signal
24	TMDS CLOCK-	TMDS Clock Differential negative signal

### 7.4 DisplayPort Input Connector

Connector: CN102 – W+P: 8470-2-2-1-80-TR

Pin No.	Signal	Description
1	ML_L3N	Main Link Ch. 3 Differential Input negative
2	GND	Ground
3	ML_L3P	Main Link Ch. 3 Differential Input positive
4	ML_L2N	Main Link Ch. 2 Differential Input negative
5	GND	Ground
6	ML_L2P	Main Link Ch. 2 Differential Input positive
7	ML_L1N	Main Link Ch. 1 Differential Input negative
8	GND	Ground
9	ML_LN1P	Main Link Ch. 1 Differential Input positive
10	ML_LN0N	Main Link Ch. 0 Differential Input negative
11	GND	Ground
12	ML_LN0P	Main Link Ch. 0 Differential Input positive
13	Config 1	Config Pin1, connect to GND with 1M
14	Config 2	Config Pin2, connect to GND with 1M
15	AUXP	Auxiliary Ch. Differential Input positive
16	GND	Ground
17	AUXN	Auxiliary Ch. Differential Input negative
18	HPD	Hot Plug Detect
19	POR	Connected to Ground
20	PO	Not Connected to internal circuits

## 7.5 LVDS Output

Connector: CN105 - Hirose DF14-30P-1.25H

Pin No.	Signal	Description
1	VCC	Panel VCC *
2	VCC	Panel VCC*
3	VCC	Panel VCC*
4	VCC	Panel VCC*
5	GND	Ground
6	3.3V	3.3V permanent for LVDS select
7	GND	Ground
8	TX3+O	TX3 odd positive
9	TX3-O	TX3 odd negative
10	TXCLK+O	Clock odd positive
11	TXCLK-O	Clock odd negative
12	TX2+O	TX2 odd positive
13	TX2-O	TX2 odd negative
14	GND	Ground
15	TX1+O	TX1 odd positive
16	TX1-O	TX1 odd negative
17	TX0+O	TX0 odd positive
18	TX0-O	TX0 odd negative
19	GND	Ground
20	TX3+E	TX3 even positive
21	TX3-E	TX3 even negative
22	TXCLK+E	Clock even positive
23	TXCLK-E	Clock even negative
24	TX2+E	TX2 even positive
25	TX2-E	TX2 even negative
26	GND	Ground
27	TX1+E	TX1 even positive
28	TX1-E	TX1 even negative
29	TX0+E	TX0 even positive
30	TX0-E	TX0 even negative

\* Note: Pin1, 2, 3, 4: Output voltage 3.3V / 5.0V / 12.0V - selectable with jumper CN200

## 7.6 Inverter / Backlight

Connector: CN107, CN108 – JST S7B-EH

Pin No.	Signal	Description
1	V dimm A	Analog dimming voltage Analog dimming range is selectable with jumper CN600
2	V dimm PWM	PWM diming output Signal level is selectable with jumper CN601
3	Enable	ON/OFF Polarity is selectable with jumper CN602
4	VDD	Operating voltage +12V / +24V VDD is selectable with the jumpers CN202, CN203, CN204. All jumpers must be set in the same position!
5	VDD	Operating voltage +12V / +24V VDD is selectable with the jumpers CN202, CN203, CN204. All jumpers must be set in the same position!
6	GND	Ground
7	GND	Ground

## 7.7 OSD Connector

Connector: CN112 – Molex 53015-1210

Pin No.	Signal	Description
1	LED1	LED Green
2	LED2	LED RED
3	IR /n.c.	IR remote / not connected
4	3.3V	
5	GND	Ground
6	SW3	Button3 (UP)
7	SW2	Button2 (DOWN)
8	SW4	Button4 (SELECT)
9	SW6	Button6 (POWER)
10	SW1	Button1 (MENU)
11	n.c.	Not connected
12	GND	Ground

## 7.8 GPIO Connector

Connector: CN110 – Molex 53261-1071

Pin No.	Signal	Description
1	3.3V	3.3V (max 200mA)
2	5.0V	5.0V (max 200mA)
3	FAN PWM	PWM signal for FAN speed
4	FAN Tacho	N.C
5	FAN VCC	
6	GPIO34	GPIO from STDP6036 (LVTTL)
7	GPIO45	GPIO from STDP6036 (LVTTL)
8	SCL	I2C SCL (5V level)
9	SDA	I2C SDA (5V level)
10	GND	Ground

Signals on the GPIO connector are not used at the moment. Reserved for custom options!

## 7.9 Systembus

Connector: CN111 – JST S4B-EH

Pin No.	Signal	Description
1	GND	Ground
2	SCL	I2C SCL (5V level)
3	SDA	I2C SDA (5V level)
4	5V	5.0V (max 200mA)

## 7.10 RS232 Connector

Connector: CN115 – MOLEX 53261-0471

Pin No.	Signal	Description
1	3.3V	3.3V (max 200mA)
2	TxD	Transmit Data (LVTTL)
3	RxD	Receive Data (LVTTL)
4	GND	Ground

Connector: CN113 – 10pin double row

Pin No.	Signal	Description
1	NC	
2	NC	
3	RxD	Receive Data (LVTTTL)
4	NC	
5	TxD	Transmit Data (LVTTTL)
6	NC	
7	NC	
8	NC	
9	GND	Ground
10	NC	

### 7.11 Fan Connector

Connector: CN114 – MOLEX 47053-1000

Pin No.	Signal	Description
1	GND	Ground
2	Fan VCC	Fan Supply (same as board supply voltage)
3	Fan Tacho	NC
4	Fan PWM	PWM Signal for Fan speed

### 7.12 Inverter Switch

Connector: CN109 – MOLEX 53261-0271

Pin No.	Signal	Description
1	Inverter Switch	Inverter ON / OFF
2	GND	Ground

## 8. Jumper settings and configuration

WARNING! Do not change the jumper settings and configuration of the board! Changing the jumpers and configuration may cause fatal damage to the board and to the connected display or cause malfunction.

### 8.1. Panel supply voltage (CN200)

The supply voltage of the panel can be selected with the Jumper CN200.

Note: Do only use one jumper cab at the same time. Combinations of jumper cabs are not allowed.

Panel Voltage	CN200		
	1-2	3-4	5-6
3.3V	closed	open	open
5.0V	open	closed	open
12.0V	open	open	closed

Table 1: Panel power supply

### 8.2. Backlight Power Supply (CN202, CN203, CN204)

Select the backlight supply voltage with the jumper CN202 to CN204.

**Note: All jumper cabs of the jumper CN202-CN204 must be set in the same position!**

CN202 CN203 CN204	Backlight supply voltage (CN107 and CN108 Pin4 and Pin5)	Comment
1-2	+12V / max 3A	Use this setting if the input voltage of the board does not match the backlight supply voltage.
2-3	Equal to board supply voltage / max 6A	This setting should be used if the input voltage of the board matches with the backlight supply voltage. The max backlight current is limited to 6A.

### 8.3. Backlight Dimming (CN600)

The range of the analog dimming voltage and the signal high level of the digital PWM dimming signal can be selected with the jumper CN600.

CN600	Analog Dimming (CN107 und CN108 Pin1)	Digital Dimming (CN107 and CN108 Pin 2)
1-2	0V – 5.0V	High level: 5.0V
2-3	0V - 3.3V	High level 3.3V

Note: Signal polarity can be changed in the panel file.

### 8.4. Backlight Enable Signal (CN601, CN602)

Select the level of the backlight enable signal (CN107 and CN108 Pin3) with the jumper CN601.

CN601	Backlight enable signal (CN107 und CN108 Pin3)
1-2	High level 5.0V
2-3	High level 3.3V

Select the polarity of the enable signal with jumper CN602.

CN602	Backlight enable signal (CN107 und CN108 Pin3)
1-2	High active
2-3	Low active

## 8.5. Panel file configuration

The panel timing is defined in a panel file. To modify the panel file you have to use the Data Modul BoardProgrammer.exe.

The board is shipped out with the correct panel and inverter configuration.

## 9. OSD (On Screen Display)

The eMotionST1:3 can operate with an external OSD board (optional item).

Generally the OSD offers the user various possibilities of customizing the appearance of the TFT display. By using the OSD board, brightness, contrast, input selection, OSD appearance and much more can be adjusted easily.

The eMotionST1:3 supports a 5 button OSD. Other customized OSDs (4button/6button) may be realized upon request.

### 9.1. Mechanical dimensions OSD board (CU70008, incl. input cable)

OSD connector CN112: Molex 53015-1210

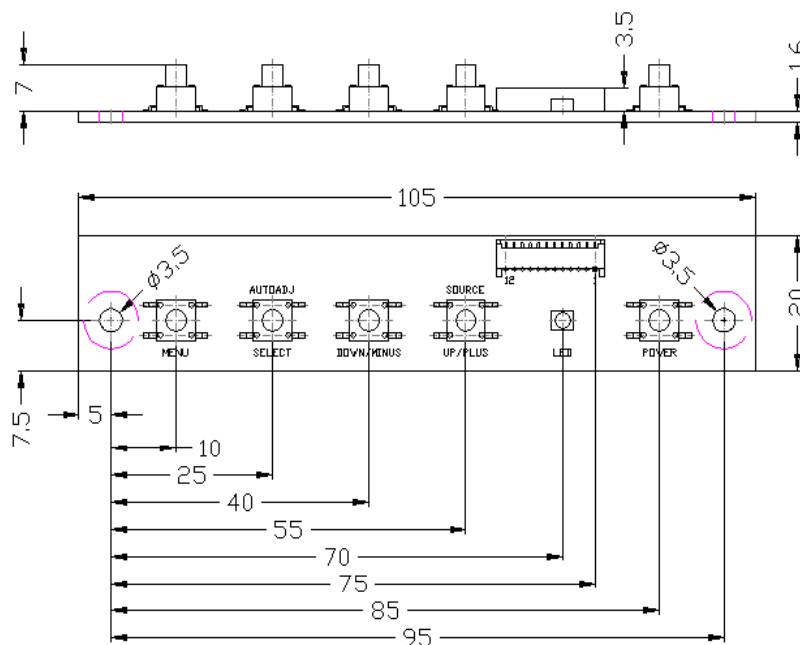

## 9.2. Operation & buttons

Item	Description
Menu	Enter OSD main menu Leave sub menu Leave OSD main menu
Select	Navigate down in menu
Down / Minus	Navigate left in main menu Decrease value
Up / Plus	Navigate up in main menu Increase value
Power	Turn power on/off
2 color LED	RED / GREEN

## 9.3. Hotkeys

The OSD offers hot key functions. To access these functions the user must not open the OSD via <Menu>. The hotkey functions offer a direct access to the equivalent function.

Button	Direct access
Up / Plus	Source select, switch to next input source
Down / Minus	Brightness
Select	Auto adjust

## 9.4. OSD Status LED

Condition	Description
Amber flashing	Stand by (searching input)
Green flashing	Searching display mode (source)
Green ON	OK (displaying signal)
Red ON	Power off

## 9.5. OSD Structure

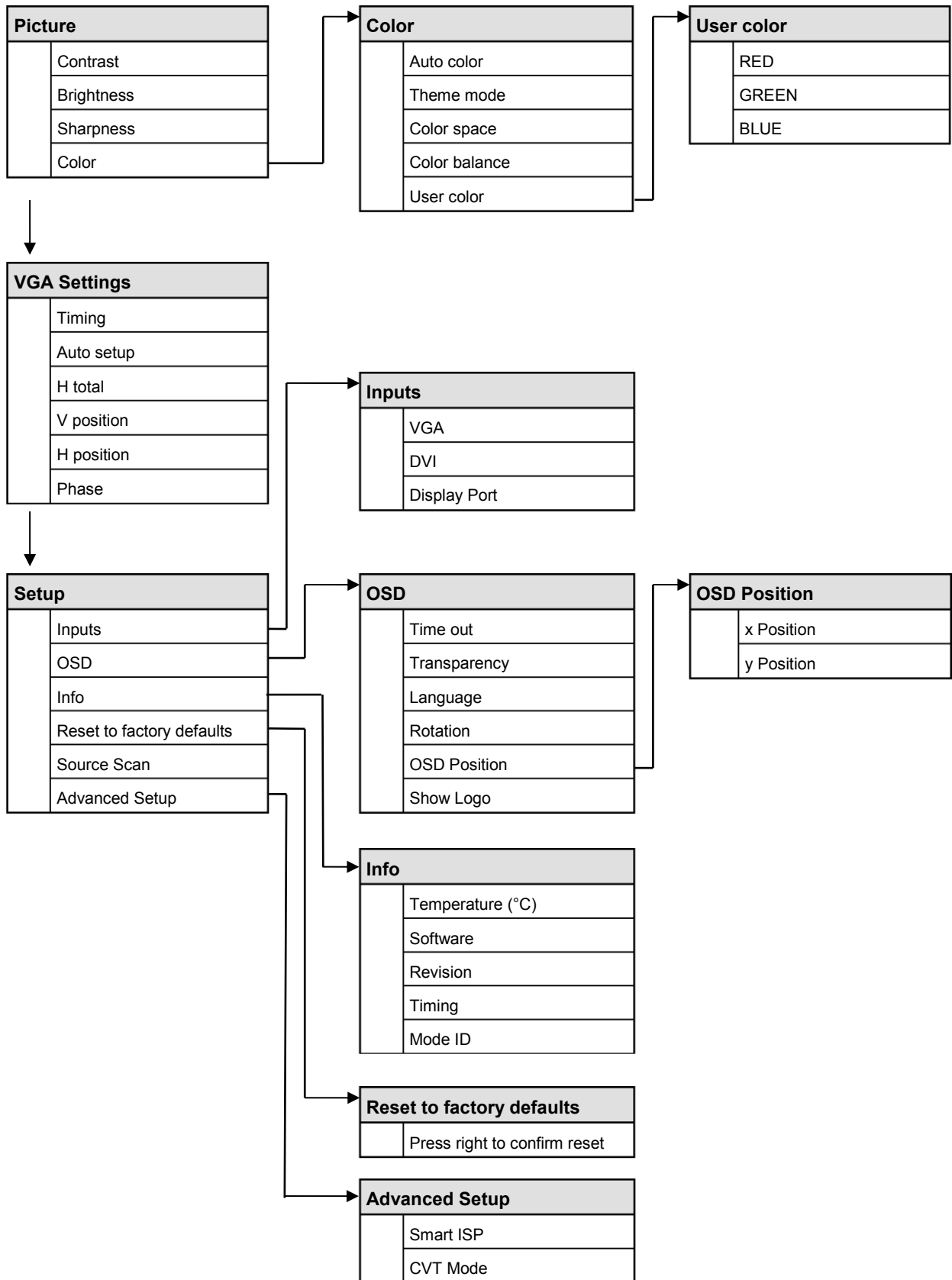

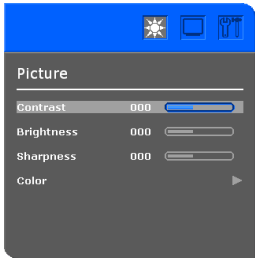

### 9.5.1 Picture Menu

	Picture	Contrast
		Brightness
		Sharpness
		Color

### 9.5.2 VGA Settings Menu

	VGA Settings	Timing
		Auto setup
		H total
		V position
		H position
		Phase

### 9.5.3 Setup Menu

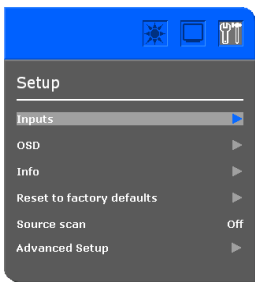
	Setup	Inputs
		OSD
		Info
		Reset to factory defaults
		Source scan
		Advanced Setup

### 9.5.4 Color Menu

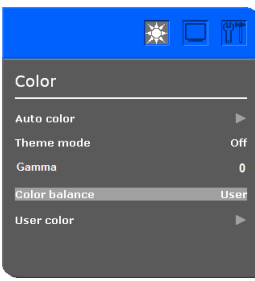
	Color	Auto color
		Theme mode
		Gamma
		Color balance
		User color

### 9.5.5 User Color Menu

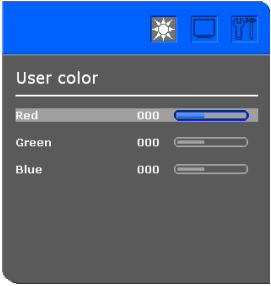
	User color	RED
		GREEN
		BLUE

### 9.5.6 Inputs Menu

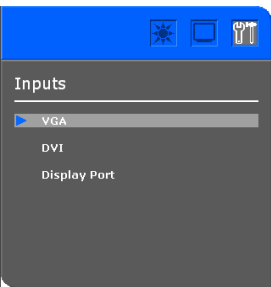
	Inputs	VGA
		DVI
		DisplayPort

### 9.5.7 OSD Menu

	OSD	Time out
		Transparency
		Language
		Rotation
		OSD Position
		Show logo

### 9.5.8 OSD Position Menu

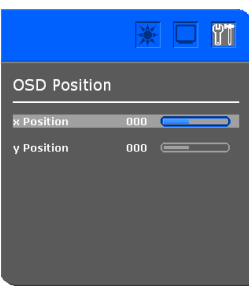
	OSD Position	x Position
		y Position

### 9.5.9 Info Menu

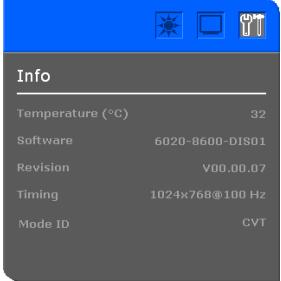
	Info	Temperature (°C)
		Software
		Revision
		Timing
		Mode ID

### 9.5.10 Advanced Setup Menu

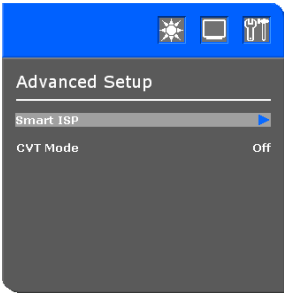
	Advanced Setup	Smart ISP
		CVT Mode

## 10. Serial Control RS232

The eMotionST3:1 can be controlled by a serial command set using the RS232. For using the RS232 a level converter from LVTTTL to RS232 level must be used. Detailed information about the RS232 protocol are provided on request!

## 11. DDC/CI Interface

The eMotionST1:3 can be controlled by DDC/CI. Detailed information are provided on request!

# LINDY PRODUCT SPECIFICATION (1 OF 1)

Length	Polybag Size	Label Size	Product Number
0.5m	FP2	LBS	<b>36270</b>
1m	FP2	LBS	<b>36271</b>
2m	FP3	LBM	<b>36272</b>
3m	FP3	LBM	<b>36273</b>
5m	FP3	LBM	<b>36274</b>

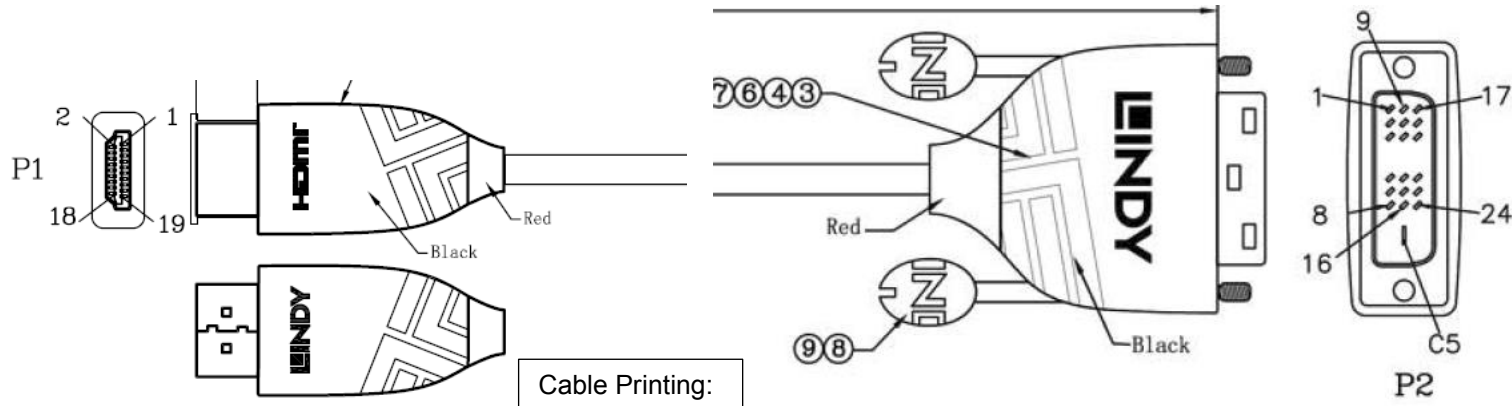

Cable Printing:

**LINDY** Black Line DVI Cable lindy.com RoHS E342987 AWM STYLE 20276 80°C 30V VW-1

- Electrical Test:**
- 100%Test(Open ,short ,miss wire)
  - Contact Resistance: 5 ohm max.
  - Insulation Resistance: 10M ohm min.
  - Hi-pot:300V DC/10ms

## Pin Assignment

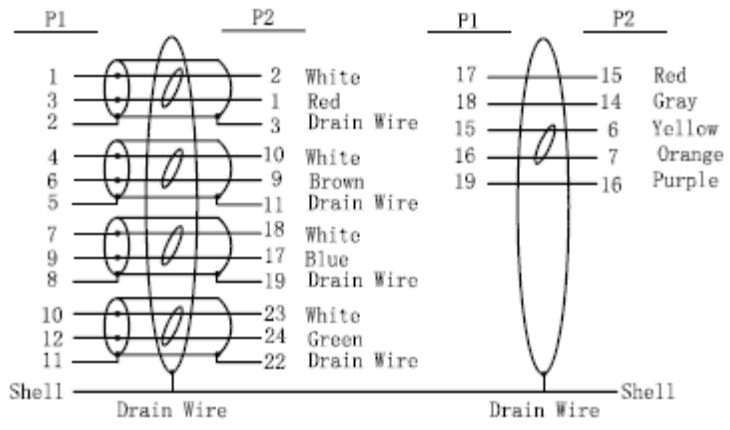

**Description:** HDMI to DVI Cable, Black Line

- Connectors: HDMI Type A male to DVI-D (18+1) male, gold plated
- Cable: UL 20276 30AWG (7/0.1TC), 85% AL-Braid, OD: 5.5mm, PVC, black / red screws/SR: Pantone 2035C
- RoHS & Reach compliant, UL certified

**Packaging:** Lindy polybag and label as above

Alterations	Issue	Date	BY	GB	DE
	0	23.05.17	ML	AI	
Cable printing changed	1	08.08.17	ML		ML
Packaging Info update	2	16.11.17	ML		ML
Red Pantone No. 2035C added	3	01.12.17	ML	AI	

Drawn By: ML 23.05.17

All connectors viewed from front

The following tolerances apply to overall dimensions -0% +10%

© LINDY Electronics Ltd., LINDY-Elektronik GmbH and LINDY group. All rights reserved.

GB Tel: +44 1642-754000 | DE Tel: +49 621-47-005-0  
Fax: +44 1642-754027 | Fax: +49 621-47-005-990



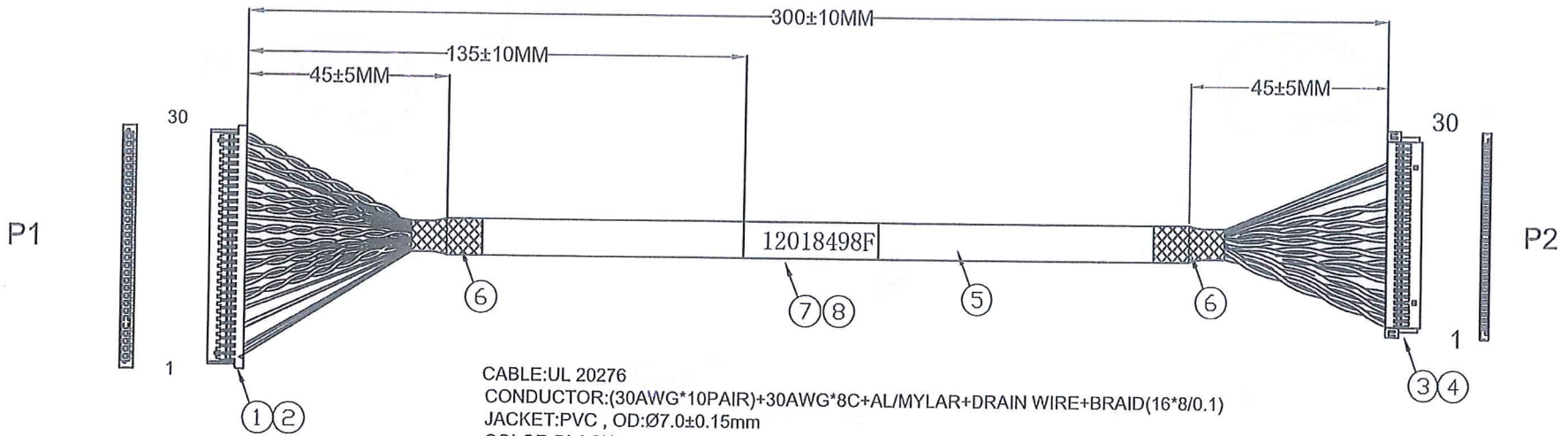

CABLE:UL 20276  
 CONDUCTOR:(30AWG\*10PAIR)+30AWG\*8C+AL/MYLAR+DRAIN WIRE+BRAID(16\*8/0.1)  
 JACKET:PVC , OD:Ø7.0±0.15mm  
 COLOR:BLACK

**PIN ASSIGNMENT**

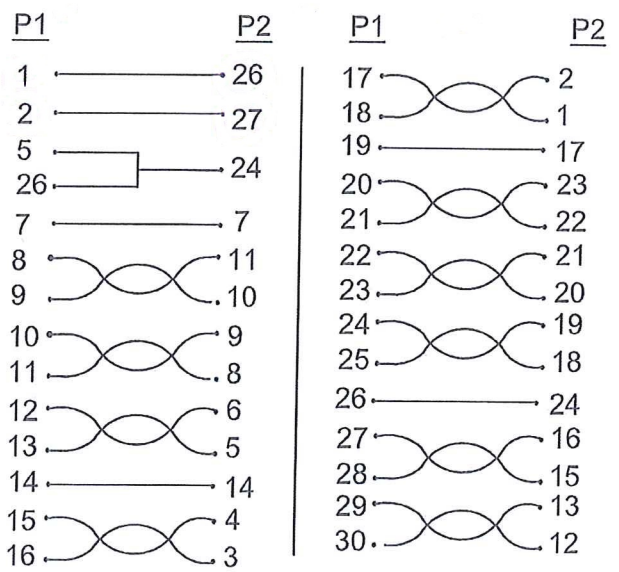

NOTE	DESCRIPTION	SUPPLIER	UL FILE NO	Q'TY	REMARK
1	P/N:KB912-30H2A PITCH 1.25*30 PIN HOUSING	XUANYE	REF.SPEC	1PCS	XUANYE
2	P/N:KB912-11T4A TERMINAL	XUANYE	REF.SPEC	28 PCS	XUANYE
3	XY P/N: KB906 -30H2A PITCH 1.0*30 PIN HOUSING	XUANYE	REF.SPEC	1 PCS	XUANYE
4	XY P/N:KB906-11T2ATERMINAL	XUANYE	REF.SPEC	27 PCS	XUANYE
5	UL 20276 (30AWG*10P)+30AWG*8C+A+D+B CABLE	COPARTNER	E119932	1 PCS	XIN YA
6	Ø8.0*25mm BLACK SHRINK TUBE	WOER	E203950	2PCS	YI JINDA
7	UL TYPE TL-SM25 Lable	FUZHOU	MH30090	1 PCS	Jin Yuanbao
8	Ø8.0*35MM Transparent shrink tube	WOER	E203950	1 PCS	YI JINDA

DRAWN	Dang 02/18	DAW NO	FT - C345 -402	TITLE KB912-30P TO KB906-30P L=300MM UL20276 Ø7.0mm cable		SCALE NON		SHEET 1 OF 1		
CHECK	Dang 02/18	PART NO	12018498F							
APPROVED		DATE	2016 . 02 . 18	UNIT	mm					

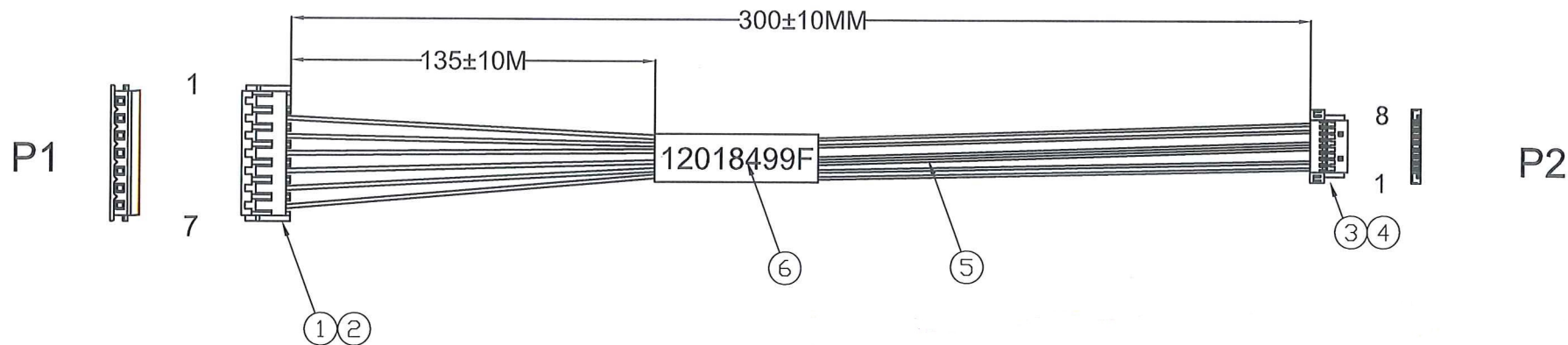

### PIN ASSIGNMENT

CLCOR	P1	P2
Yellow	2	2
Yellow	3	1
RED	4	4
RED	5	5
BLACK	6	7
BLACK	7	8

NOTE	DESCRIPTION	SUPPLIER	UL FILE NO	Q'TY	REMARK
1	JST : EHR-7 PITCH 2.54mm*7P HOUSING	JST	E60389	1 PCS	JST
2	JST :SEH-001T-P0.6 terminal	JST	E60389	6 PCS	JST
3	HR P/N:A1007H-08P , PITCH 1.0mm*8P HOUSING	JOINT TECH	E179987	1PCS	JOINT TECH
4	HR P/N:A1007-GPE , TERMINAL	JOINT TECH	E179987	6PCS	JOINT TECH
5	CABLE:UL 30AWG ID:Ø0.55±0.05 CABLE	COPARTNER	E119932	6 PCS	XIN YA
6	WHITE SHRINK TUBE WITH LABLE	WOER	E203950	1 PCS	YI JINDA

DRAWN	<i>Dong 02/18</i>	DAW NO	FT - C345 -403	TITLE EHR-7 TO A1007H-8P L=300 mm UL30 AWG CABLE		SCALE NON		SHEET 1 OF 1		
CHECK	<i>Dong 02/18</i>	PART NO	12018499F							
APPROVED		DATE	2016. 02. 18	UNIT	mm					



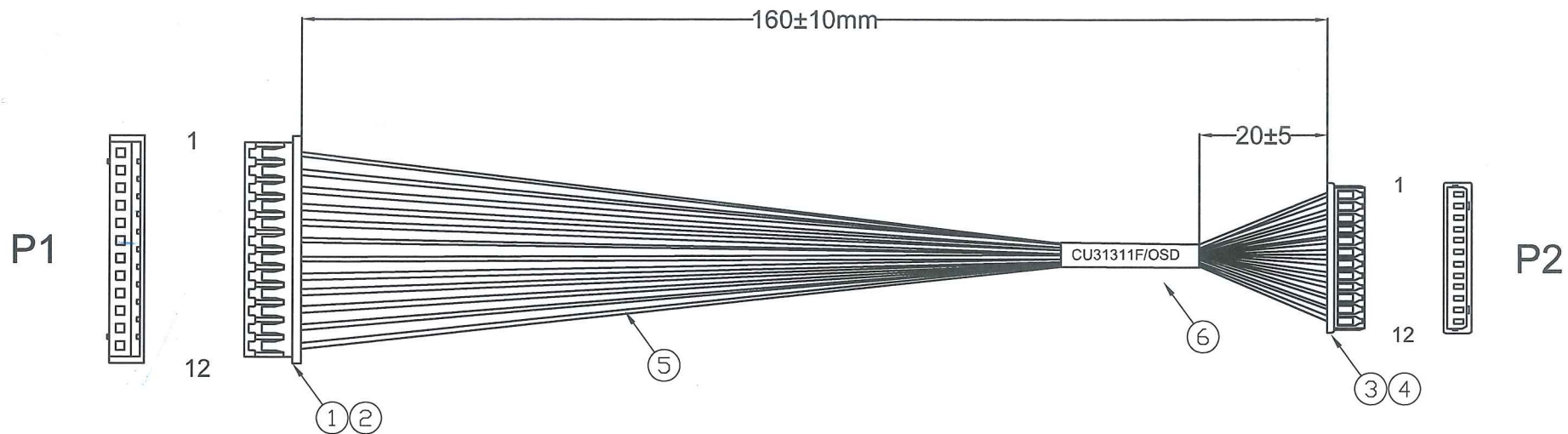

**PIN ASSIGNMENT**

CLCOR	P1	P2
RED	1	12
BLACK	2	11
WHITE	3	10
RED	4	9
BLACK	5	8
WHITE	6	7
RED	7	6
BLACK	8	5
WHITE	9	4
RED	10	3
BLACK	11	2
WHITE	12	1

NOTE	DESCRIPTION	SUPPLIER	UL FILE NO	Q'TY	REMARK
1	CKM P/N: CKM 2006-12P PITCH 2.0*12P HOUSING	CHAO KUEI	E186634	1PCS	CHAO KUEI
2	CKM P/N: CKM 2006-T TERMINAL	CHAO KUEI	E186634	12PCS	CHAO KUEI
3	XY P/N:KB915-12H3A , 1.25mm*12P HOUSING	XUANYE	REF.SPEC	1PCS	XUANYE
4	XY P/N:KB915-T , 1.25mm TERMINAL	XUANYE	REF.SPEC	12PCS	XUANYE
5	CABLE:UL1061 28AWG CABLE	COPARTNER	E119932	12PCS	XIN YA
6	WHITE SHRINK TUBE WITH LABE	WOER	E203950	1PCS	YI JINDA

DRAWN	Dong 12/15	DAW NO	FT - C345 -320	TITLE CKM 2006-12P HOUSING to KB915-12P HOUSING L=160 mm		SCALE NON		SHEET 1 OF 1		
CHECK	Dong 12/15	PART NO	CU31311F							
APPROVED	<i>[Signature]</i> 2015.12.15	DATE	2015 . 12. 15	UNIT	m m					

Customer Approved

ROHS

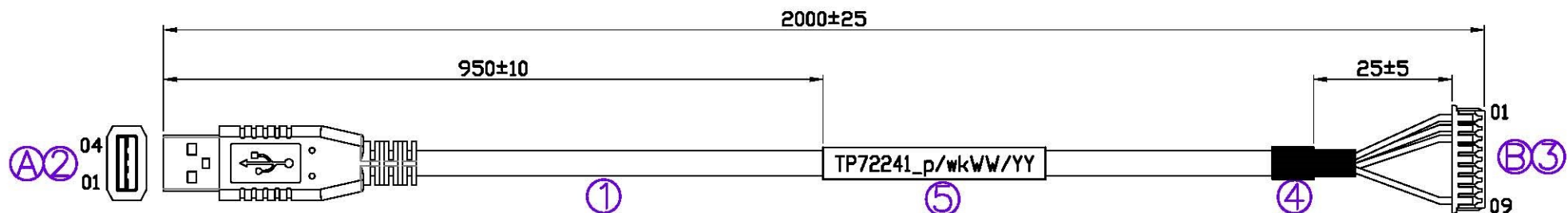

PACKING:

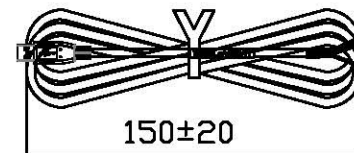

PIN ASSIGNMENT		
A	B	COLOR
1	1	RED
2	2	WHITE
3	3	GREEN
4	9	BLACK
SHELL		DRAIN

大琬國際股份有限公司  
發行 確認 設變 圖面章  
 28-Aug-18  
 工程 部： KELLY

5	WHITE HEAT SHRINK TUBE UL 4φ*50MM PRINTING "TP72241_p/wkWW/YY"	YUN LIN CHANGYUAN	E255532 E180908
4	BLACK HEAT SHRINK TUBE F34 UL 4φ*25MM	SUMITOMO DONGGUAN	E75077 E364978
3	HOUSING: MOLEX 51021-0900 TERMINAL: MOLEX 50058-8000	MOLEX	E29179
2	USB A MALE ,MOLDING:BLACK	SHANGZHOU YU CHUN	E237064 E363107
1	UL2725 28AWG*2C ,28AWG*1P ,ABE JACKET:BLACK ,OD : 3.5±0.15mm	CHUAN WEI FREEWAY	E138961 E257034
ITEM	MATERIAL	MANUFACTURER	UL FILE

			Approved		Part no	TP72241
			Checked		Item	AS50000670A
Rev.	Date	Description	Drawing	TONY	Drawing no	PDED_TP72241
			Customer	EU0137	Unit:mm	
			Date	APR/13/2018	Sheet:1/1	



3rd Angle Projection



COMPONENT		UNIT #28AWGX1P+#28AWGX2C+AL/MYLAR+E+SPIRAL		
COMPONENT A TWISTED PAIR	NO OF PAIR	EACH 1		
	CONDUCTOR	CONSTITUTION	28AWG 7/0.127±0.008	
		MATERIAL	TINNED COPPER STRANDED	
		OD	MM 0.38 (REF)	
	INSULATION	MATERIAL	HD-PE	
		THICKNESS	MM 0.23 (REF)	
		O D.	MM 0.85±0.05	
		COLOR	WHITE&GREEN	
	COMPONENT B SINGLE WIRE	NO OF WIRE	2	
		CONDUCTOR	CONSTITUTION	28AWG 7/0.127±0.008
MATERIAL			TINNED COPPER STRANDED	
OD.			MM 0.38 (REF)	
INSULATION		MATERIAL	SR-PVC	
		THICKNESS	MM 0.23 (REF)	
		O D.	MM 0.85±0.05	
		COLOR	1.RED 2.BALCK	
AL/MYLAR(AL. FACE OUTSIDE)		COVERAGE	%	100
		OVERLAP	%	25
DRAIN WIRE		28AWG 7/0.127±0.008 TINNED COPPER STRANDED		
SPIRAL SHIELD	CONSTITUTION	40±3/0.12±0.008		
	MATERIAL	TINNED COPPER WIRE		
JACKET	MATERIAL	FR-PVC		
	THICKNESS	MM	0.45 (REF)	
	HARDNESS	HA	75±5	
	O. D.	MM	3.5±0.15	
	COLOR	BLACK (FREEWAY COLOR CODE 140C)		
UL		UL 2725		
TEMPERATURE		°C	80	
VOLTAGE RATING		V	30	
DIELECTRIC STRENGTH		AC-500V/1 MIN		
INSULATION RESISTANCE		SR-PVC 50 M OHM/KM MIN. AT 20°C		
		HD-PE 100 M OHM/KM MIN. AT 20°C		
CONDUCTOR RESISTANCE		28AWG 237 OHM/KM MAX. AT 20°C		
		24AWG 93 OHM/KM MAX. AT 20°C		
SPARK TEST		AC-2KV IN AIR		
JACKET MARKING		見 AWM E257034 FREEWAY STYLE 2725 80°C 30V VW-1 28AWG/1P+28AWG/2C USB 2.0 CABLE		

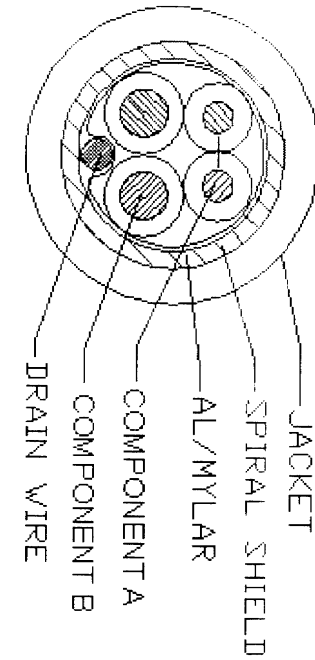

東莞富偉電線有限公司 <b>FREWAYELECTRONICWIRE&amp;CABLE(DONGGUAN)CO.,LTD</b>			
CUSTOMER	晶泰	VERSION	A
APPD		SHEET NO.	N11019-A
CHKD		PART NO	
DR		DATE:	2011/06/24

### 65 Watts

- Energy Efficiency Level VI
- CoC Tier 2
- Limited Power Source Approved
- <0.15 W Standby Power
- Optional Inlet Connector
- China Compulsory Certification (CCC) Qualified
- 0 °C to 60 °C Operation
- High Power Density
- Low Cost



#### Dimensions:

##### VEC65:

4.58 x 2.06 x 1.23" (116.3 x 52.4 x 31.3 mm)

### Models & Ratings

Output Power	Output Voltage	Output Current	Total Regulation	Efficiency <sup>(1)</sup>	Model Number
65 W	12.0V	5.41 A	±5%	89%	VEC65US12
	19.0V	3.42 A		89%	VEC65US19
	24.0V	2.71 A		89%	VEC65US24

### Notes

1. Typical average of efficiencies measured at 25%, 50%, 75% and 100% load and 230 VAC input.

### Mechanical Details

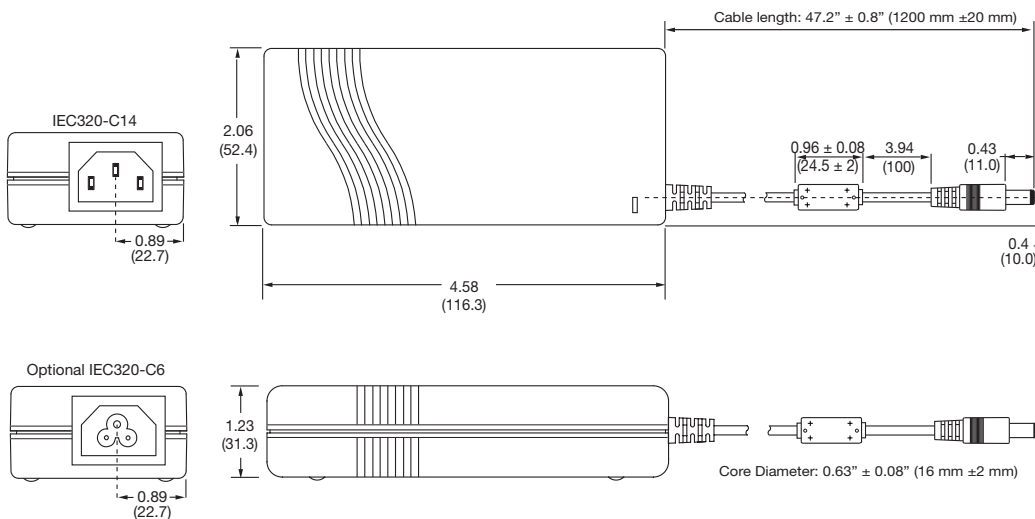

Power Cord for C14 inlet, Order Part:

UK - UK-MAINS-IEC  
 European - EU-MAINS-IEC  
 US - US-MAINS-IEC

Power Cord for C6 inlet, Order Part:

UK - UK-MAINS-5  
 European - EU-MAINS-5  
 US - US-MAINS-5

### Notes

1. All dimensions are shown in inches (mm), Tolerance is 0.04" (±1.0) max except output lead.

2. Weight: 0.6 lbs (270 g) approx.

3. Output connector is barrel type with 11 mm length, 5.5 mm dia. outer, 2.5 mm dia. inner with center + and outer shell - polarity.

### Input

Characteristic	Minimum	Typical	Maximum	Units	Notes & Conditions
Input Voltage	90		264	VAC	
Input Frequency	47		63	Hz	
Input Current		1.3/0.9		A	Measured at 115/230 VAC
Inrush Current			70	A	230 VAC, cold start at 25 °C
Power Factor					EN61000-3-2 Class A
Earth Leakage Current			0.7	mA	264 VAC, 60 Hz
No Load Input Power			0.15	W	
Input Protection	T3.15A/250 VAC internal fuse in line				

### Output

Characteristic	Min.	Typ.	Max.	Units	Notes & Conditions
Output Voltage	12		24	VDC	See Models and Ratings table
Minimum Load					No minimum load required
Start Up Delay			3	s	
Start Up Rise Time		8		ms	
Hold Up Time	8			ms	Full load and 115 VAC
Line Regulation			±0.5	%	
Total Regulation			±5	%	Including initial set accuracy
Transient Response			4	%	Maximum deviation, recovering to less than 1% within 500 µs for 25% step load
Ripple and Noise			240	mV pk-pk	Measured with 20 MHz Bandwidth and 22 µF electrolytic in parallel with 0.1 µF ceramic capacitor.
Overshoot		5		%	At turn on / turn off
Overload Protection	110		170	%	
Overvoltage Protection		150		%	Recycle mains to reset
Short Circuit Protection	Trip and restart (hiccup), auto resetting				
Temperature Coefficient		±0.04		%/°C	

### Environmental

Characteristic	Minimum	Typical	Maximum	Units	Notes & Conditions
Operating Temperature	0		+60	°C	Derate from 100% load at 40 °C to 50% load at 60 °C
Cooling	Natural convection				
Operating Humidity	5		90	%RH	Non-condensing
Storage Temperature	-20		+85	°C	
Operating Altitude			5000	m	
Shock	IEC68-2-27, 30 g, 11 ms half sine, 3 times in each of 6 axes				
Vibration	IEC68-2-6, 10-500 Hz, 2 g 10 mins/sweep, 60 mins for each of 3 axes				

### Derating Curve

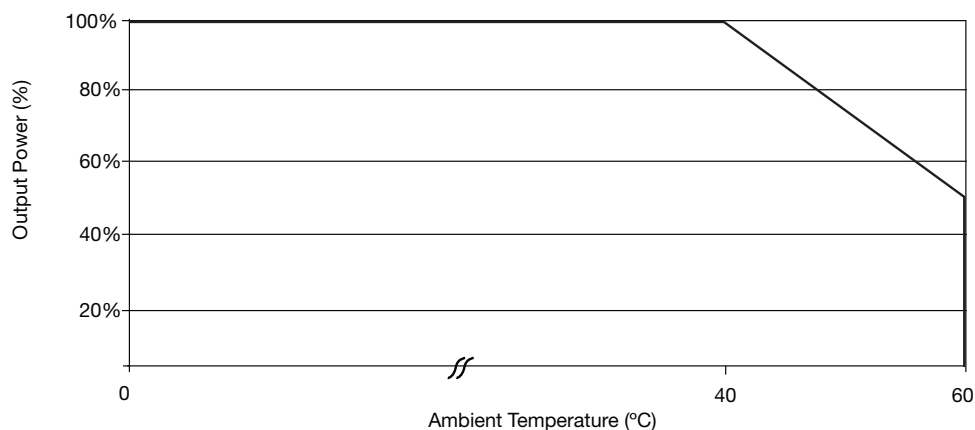

### General

Characteristic	Minimum	Typical	Maximum	Units	Notes & Conditions
Efficiency		90		%	See Models and Ratings table and curves.
Isolation: Input to Output Input to Ground Output to Ground			3000	VAC	
			1500	VAC	
Switching Frequency		65		kHz	±10 kHz
Power Density			5.6	W/in <sup>3</sup>	
Mean Time Between Failure		>200		kHrs	MIL-HDBK-217F at 25 °C GB
Weight		0.6 (270)		lb (g)	

### Efficiency Curves

#### VEC65US12

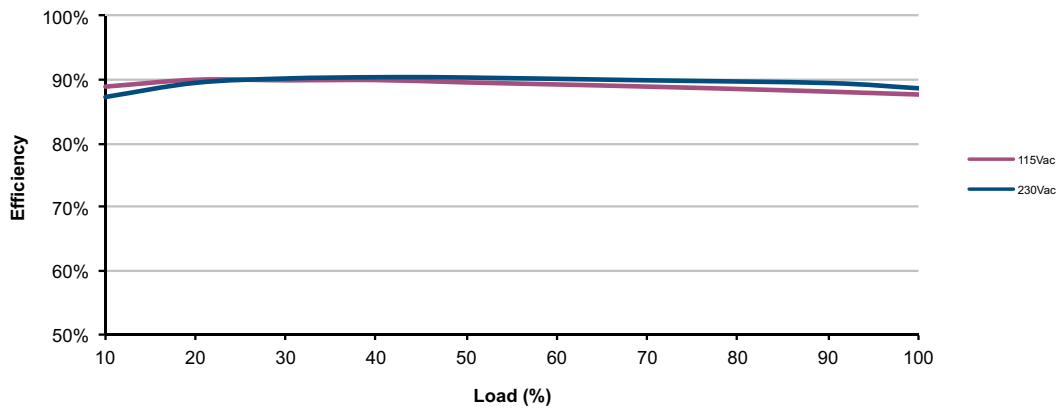

#### VEC65US24

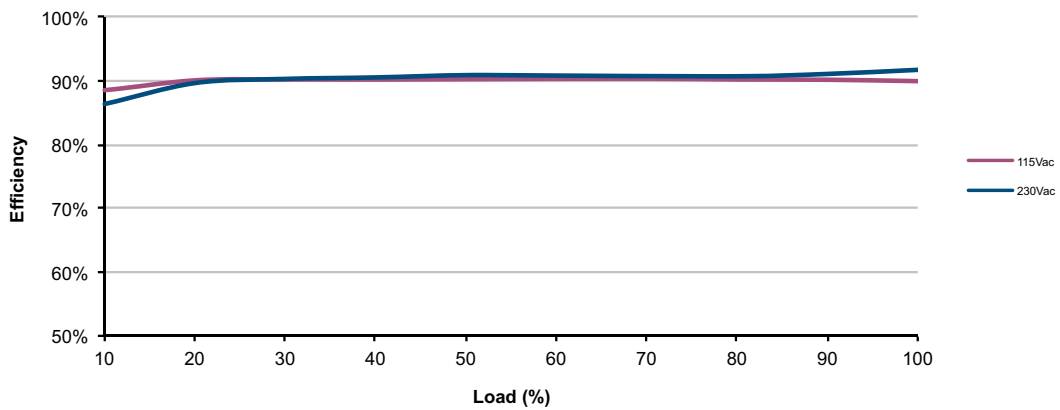

### EMC: Emissions

Phenomenon	Standard	Test Level	Notes & Conditions
Emissions	EN55022	Level B	Conducted & Radiated
Harmonic Current	EN61000-3-2	Class A	
Voltage Flicker	EN61000-3-3		

### EMC: Immunity

Phenomenon	Standard	Test Level	Criteria	Notes & Conditions
ESD	EN61000-4-2	±8 kV Air, ±4 kV contact	A	
Radiated	EN61000-4-3	3 V/m	A	
EFT/Burst	EN61000-4-4	3	A	
Surge	EN61000-4-5	Installation Class 3	A	
Conducted	EN61000-4-6	3 V	A	
Magnetic Fields	EN61000-4-8	3 A/m	A	
Dips and Interruptions	EN61000-4-11	Dip: 30% 500 ms	A/B	High Line/Low Line
		Dip: 60% 200 ms	A/B	High Line/Low Line
		Int:100% 5000 ms	B	

### Safety Approvals

Safety Agency	Safety Standard	Notes & Conditions
UL/CSA	cUL60950-1	Approved at Limited Power Source (LPS)
TUV	EN60950-1	
CB	IEC60950-1	
CCC	China Compulsory Certification (CCC)	

### Mechanical Details

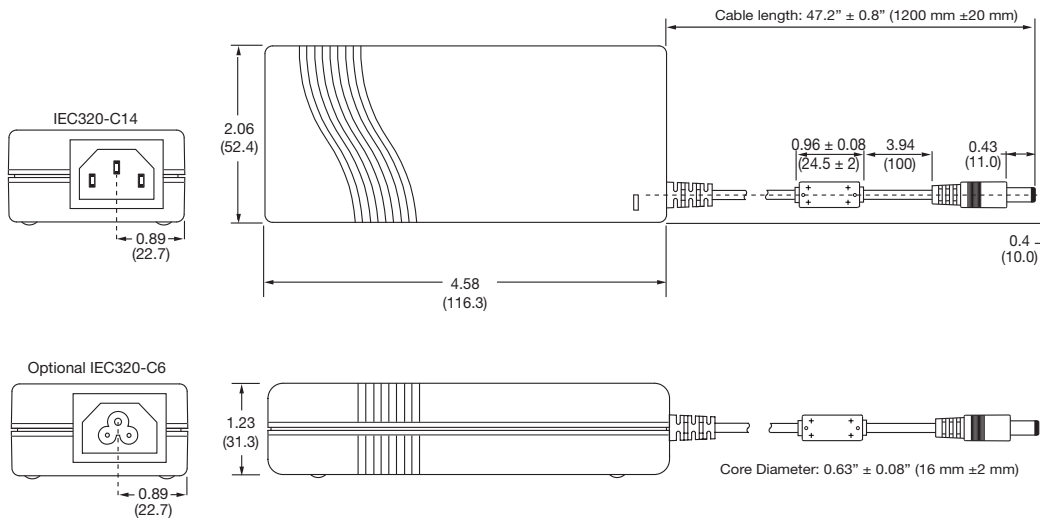





























































**Power Cord for C14 inlet, Order Part:**  
 UK - UK-MAINS-IEC  
 European - EU-MAINS-IEC  
 US - US-MAINS-IEC





























































**Power Cord for C6 inlet, Order Part:**  
 UK - UK-MAINS-5  
 European - EU-MAINS-5  
 US - US-MAINS-5





























































### Notes

- All dimensions are shown in inches (mm), Tolerance is 0.04" (±1.0) max except output lead.
- Weight: 0.6 lbs (270 g) approx.
- Output connector is barrel type with 11 mm length, 5.5 mm dia. outer, 2.5 mm dia. inner with center + and outer shell - polarity.

<b>Description</b>	<b>Power Cord</b>	
Manufacturer / Type	Taiwan Line Tek Electronic Co., Ltd.	<input type="checkbox"/> UL category code ELBZ listed, number:
Supplier / Type	Elektrosil GmbH / DK06214 NK-01.8	
Ratings	10A / 250VAC	
Length / Colour	1.8m / black	

<b>Plug</b>																						
Kind of construction	LP-33 (DIN 49441-R2)																					
Manufacturer / Type	Longwell Company																					
Ratings	10A / 250VAC																					
Required approval marks / certificates	<input type="checkbox"/> or: <table border="0"> <tr> <td><input checked="" type="checkbox"/>  Europe</td> <td><input checked="" type="checkbox"/>  Germany</td> <td><input checked="" type="checkbox"/>  Norway</td> <td><input checked="" type="checkbox"/>  Sweden</td> <td><input checked="" type="checkbox"/>  Denmark</td> <td><input checked="" type="checkbox"/>  Finland</td> <td><input checked="" type="checkbox"/>  Belgium</td> <td><input type="checkbox"/>  Russia</td> <td><input type="checkbox"/>  U.S.A</td> <td><input type="checkbox"/>  Canada</td> </tr> <tr> <td><input type="checkbox"/>  United Kingdom</td> <td><input type="checkbox"/>  British Stand</td> <td><input checked="" type="checkbox"/>  Swiss</td> <td><input checked="" type="checkbox"/>  Austria</td> <td><input checked="" type="checkbox"/>  France</td> <td><input type="checkbox"/>  Italy</td> <td><input checked="" type="checkbox"/>  Netherl.</td> <td><input type="checkbox"/>  Japan</td> <td><input type="checkbox"/>  China</td> <td><input type="checkbox"/>  South Africa</td> </tr> </table>		<input checked="" type="checkbox"/>  Europe	<input checked="" type="checkbox"/>  Germany	<input checked="" type="checkbox"/>  Norway	<input checked="" type="checkbox"/>  Sweden	<input checked="" type="checkbox"/>  Denmark	<input checked="" type="checkbox"/>  Finland	<input checked="" type="checkbox"/>  Belgium	<input type="checkbox"/>  Russia	<input type="checkbox"/>  U.S.A	<input type="checkbox"/>  Canada	<input type="checkbox"/>  United Kingdom	<input type="checkbox"/>  British Stand	<input checked="" type="checkbox"/>  Swiss	<input checked="" type="checkbox"/>  Austria	<input checked="" type="checkbox"/>  France	<input type="checkbox"/>  Italy	<input checked="" type="checkbox"/>  Netherl.	<input type="checkbox"/>  Japan	<input type="checkbox"/>  China	<input type="checkbox"/>  South Africa
<input checked="" type="checkbox"/>  Europe	<input checked="" type="checkbox"/>  Germany	<input checked="" type="checkbox"/>  Norway	<input checked="" type="checkbox"/>  Sweden	<input checked="" type="checkbox"/>  Denmark	<input checked="" type="checkbox"/>  Finland	<input checked="" type="checkbox"/>  Belgium	<input type="checkbox"/>  Russia	<input type="checkbox"/>  U.S.A	<input type="checkbox"/>  Canada													
<input type="checkbox"/>  United Kingdom	<input type="checkbox"/>  British Stand	<input checked="" type="checkbox"/>  Swiss	<input checked="" type="checkbox"/>  Austria	<input checked="" type="checkbox"/>  France	<input type="checkbox"/>  Italy	<input checked="" type="checkbox"/>  Netherl.	<input type="checkbox"/>  Japan	<input type="checkbox"/>  China	<input type="checkbox"/>  South Africa													

<b>Appliance Connector</b>																						
Kind of construction	LS-13 (IEC 60320 C13)																					
Manufacturer / Type	Longwell Company																					
Ratings	10A / 250VAC																					
Required approval marks / certificates	<input type="checkbox"/> or: <table border="0"> <tr> <td><input checked="" type="checkbox"/>  Europe</td> <td><input checked="" type="checkbox"/>  Germany</td> <td><input type="checkbox"/>  Norway</td> <td><input checked="" type="checkbox"/>  Sweden</td> <td><input checked="" type="checkbox"/>  Denmark</td> <td><input checked="" type="checkbox"/>  Finland</td> <td><input checked="" type="checkbox"/>  Belgium</td> <td><input type="checkbox"/>  Russia</td> <td><input type="checkbox"/>  U.S.A</td> <td><input type="checkbox"/>  Canada</td> </tr> <tr> <td><input type="checkbox"/>  United Kingdom</td> <td><input type="checkbox"/>  British Stand</td> <td><input type="checkbox"/>  Swiss</td> <td><input checked="" type="checkbox"/>  Austria</td> <td><input type="checkbox"/>  France</td> <td><input type="checkbox"/>  Italy</td> <td><input checked="" type="checkbox"/>  Netherl.</td> <td><input type="checkbox"/>  Japan</td> <td><input type="checkbox"/>  China</td> <td><input type="checkbox"/>  South Africa</td> </tr> </table>		<input checked="" type="checkbox"/>  Europe	<input checked="" type="checkbox"/>  Germany	<input type="checkbox"/>  Norway	<input checked="" type="checkbox"/>  Sweden	<input checked="" type="checkbox"/>  Denmark	<input checked="" type="checkbox"/>  Finland	<input checked="" type="checkbox"/>  Belgium	<input type="checkbox"/>  Russia	<input type="checkbox"/>  U.S.A	<input type="checkbox"/>  Canada	<input type="checkbox"/>  United Kingdom	<input type="checkbox"/>  British Stand	<input type="checkbox"/>  Swiss	<input checked="" type="checkbox"/>  Austria	<input type="checkbox"/>  France	<input type="checkbox"/>  Italy	<input checked="" type="checkbox"/>  Netherl.	<input type="checkbox"/>  Japan	<input type="checkbox"/>  China	<input type="checkbox"/>  South Africa
<input checked="" type="checkbox"/>  Europe	<input checked="" type="checkbox"/>  Germany	<input type="checkbox"/>  Norway	<input checked="" type="checkbox"/>  Sweden	<input checked="" type="checkbox"/>  Denmark	<input checked="" type="checkbox"/>  Finland	<input checked="" type="checkbox"/>  Belgium	<input type="checkbox"/>  Russia	<input type="checkbox"/>  U.S.A	<input type="checkbox"/>  Canada													
<input type="checkbox"/>  United Kingdom	<input type="checkbox"/>  British Stand	<input type="checkbox"/>  Swiss	<input checked="" type="checkbox"/>  Austria	<input type="checkbox"/>  France	<input type="checkbox"/>  Italy	<input checked="" type="checkbox"/>  Netherl.	<input type="checkbox"/>  Japan	<input type="checkbox"/>  China	<input type="checkbox"/>  South Africa													





























































<b>Cable</b>																						
Kind of construction	H05VV-F 3G 0.75mm <sup>2</sup>																					
Manufacturer / Type	Longwell Company																					
Ratings	10A, 250VAC																					
Required approval marks / certificates	<input type="checkbox"/> or: <table border="0"> <tr> <td><input checked="" type="checkbox"/>  Europe</td> <td><input checked="" type="checkbox"/>  Germany</td> <td><input checked="" type="checkbox"/>  Norway</td> <td><input checked="" type="checkbox"/>  Sweden</td> <td><input checked="" type="checkbox"/>  Denmark</td> <td><input checked="" type="checkbox"/>  Finland</td> <td><input checked="" type="checkbox"/>  Belgium</td> <td><input type="checkbox"/>  Russia</td> <td><input type="checkbox"/>  U.S.A</td> <td><input type="checkbox"/>  Canada</td> </tr> <tr> <td><input type="checkbox"/>  United Kingdom</td> <td><input type="checkbox"/>  British Stand</td> <td><input checked="" type="checkbox"/>  Swiss</td> <td><input checked="" type="checkbox"/>  Austria</td> <td><input checked="" type="checkbox"/>  France</td> <td><input type="checkbox"/>  Italy</td> <td><input checked="" type="checkbox"/>  Netherl.</td> <td><input type="checkbox"/>  Japan</td> <td><input type="checkbox"/>  China</td> <td><input type="checkbox"/>  South Africa</td> </tr> </table>		<input checked="" type="checkbox"/>  Europe	<input checked="" type="checkbox"/>  Germany	<input checked="" type="checkbox"/>  Norway	<input checked="" type="checkbox"/>  Sweden	<input checked="" type="checkbox"/>  Denmark	<input checked="" type="checkbox"/>  Finland	<input checked="" type="checkbox"/>  Belgium	<input type="checkbox"/>  Russia	<input type="checkbox"/>  U.S.A	<input type="checkbox"/>  Canada	<input type="checkbox"/>  United Kingdom	<input type="checkbox"/>  British Stand	<input checked="" type="checkbox"/>  Swiss	<input checked="" type="checkbox"/>  Austria	<input checked="" type="checkbox"/>  France	<input type="checkbox"/>  Italy	<input checked="" type="checkbox"/>  Netherl.	<input type="checkbox"/>  Japan	<input type="checkbox"/>  China	<input type="checkbox"/>  South Africa
<input checked="" type="checkbox"/>  Europe	<input checked="" type="checkbox"/>  Germany	<input checked="" type="checkbox"/>  Norway	<input checked="" type="checkbox"/>  Sweden	<input checked="" type="checkbox"/>  Denmark	<input checked="" type="checkbox"/>  Finland	<input checked="" type="checkbox"/>  Belgium	<input type="checkbox"/>  Russia	<input type="checkbox"/>  U.S.A	<input type="checkbox"/>  Canada													
<input type="checkbox"/>  United Kingdom	<input type="checkbox"/>  British Stand	<input checked="" type="checkbox"/>  Swiss	<input checked="" type="checkbox"/>  Austria	<input checked="" type="checkbox"/>  France	<input type="checkbox"/>  Italy	<input checked="" type="checkbox"/>  Netherl.	<input type="checkbox"/>  Japan	<input type="checkbox"/>  China	<input type="checkbox"/>  South Africa													

03					
02					
01					
00	01.06.2011	Dietrich		Dietrich	New
Rev	DATE	DRWN.BY	CHKD.BY	E D V	MODIFICATION / DESCRIPTION





























































Vorlage_Spec AC Power Cord_Rev00	DRGW. TITLE	 DRAWING NUMBER ..... <b>2215-11A0-1800</b>
	<b>Power Cord Set</b>	
	SIZE ISO A 4	SHEET 1 OF 1

<b>Description</b>	<b>Power cord set, North America type</b>	
Manufacturer / Type	<b>Feller 498G-SJT3X18AWG-C13</b>	<input checked="" type="checkbox"/> UL category code ELBZ listed, number: <b>E42003</b>
Supplier / Type		
Ratings	10 A, 125 Vac,	
Length / Colour	2,50m / black	





























































**Plug**

Kind of construction	PVC 3-pole, 180 degree, NEMA 5-15																					
Manufacturer / Type	<b>Feller / 498G</b>																					
Ratings	15A / 125 Vac																					
Required approval marks / certificates	 <table border="1"> <tr> <td><input type="checkbox"/> or: </td> <td><input type="checkbox"/> </td> <td><input type="checkbox"/> </td> <td><input type="checkbox"/> </td> <td><input type="checkbox"/> </td> <td><input type="checkbox"/> </td> <td><input type="checkbox"/> </td> <td><input type="checkbox"/> </td> <td><input checked="" type="checkbox"/> </td> <td><input checked="" type="checkbox"/> </td> </tr> <tr> <td><input type="checkbox"/> </td> <td><input type="checkbox"/> </td> <td><input checked="" type="checkbox"/> </td> <td><input type="checkbox"/> </td> <td><input type="checkbox"/> </td> <td><input type="checkbox"/> </td> <td><input type="checkbox"/> </td> <td><input type="checkbox"/> </td> <td><input type="checkbox"/> </td> <td><input type="checkbox"/> </td> </tr> </table>		<input type="checkbox"/> or: 	<input type="checkbox"/> 	<input type="checkbox"/> 	<input type="checkbox"/> 	<input type="checkbox"/> 	<input type="checkbox"/> 	<input type="checkbox"/> 	<input type="checkbox"/> 	<input checked="" type="checkbox"/> 	<input checked="" type="checkbox"/> 	<input type="checkbox"/> 	<input type="checkbox"/> 	<input checked="" type="checkbox"/> 	<input type="checkbox"/> 	<input type="checkbox"/> 	<input type="checkbox"/> 	<input type="checkbox"/> 	<input type="checkbox"/> 	<input type="checkbox"/> 	<input type="checkbox"/> 
<input type="checkbox"/> or: 	<input type="checkbox"/> 	<input type="checkbox"/> 	<input type="checkbox"/> 	<input type="checkbox"/> 	<input type="checkbox"/> 	<input type="checkbox"/> 	<input type="checkbox"/> 	<input checked="" type="checkbox"/> 	<input checked="" type="checkbox"/> 													
<input type="checkbox"/> 	<input type="checkbox"/> 	<input checked="" type="checkbox"/> 	<input type="checkbox"/> 	<input type="checkbox"/> 	<input type="checkbox"/> 	<input type="checkbox"/> 	<input type="checkbox"/> 	<input type="checkbox"/> 	<input type="checkbox"/> 													

**Appliance Connector**

Kind of construction	PVC 2-pole with earthing contact, 180 degrees, IEC 60320 / C13, UL 817																					
Manufacturer / Type	<b>Feller / C13</b>																					
Ratings	12 A/250 Vac (USA, Canada), 7 A/125 Vac (Japan), 10 A/250 Vac																					
Required approval marks / certificates	 <table border="1"> <tr> <td><input checked="" type="checkbox"/> or: </td> <td><input type="checkbox"/> </td> <td><input type="checkbox"/> </td> <td><input type="checkbox"/> </td> <td><input type="checkbox"/> </td> <td><input type="checkbox"/> </td> <td><input type="checkbox"/> </td> <td><input type="checkbox"/> </td> <td><input checked="" type="checkbox"/> </td> <td><input checked="" type="checkbox"/> </td> </tr> <tr> <td><input type="checkbox"/> </td> <td><input type="checkbox"/> </td> <td><input type="checkbox"/> </td> <td><input type="checkbox"/> </td> <td><input type="checkbox"/> </td> <td><input type="checkbox"/> </td> <td><input type="checkbox"/> </td> <td><input checked="" type="checkbox"/> </td> <td><input checked="" type="checkbox"/> </td> <td><input type="checkbox"/> </td> </tr> </table>		<input checked="" type="checkbox"/> or: 	<input type="checkbox"/> 	<input type="checkbox"/> 	<input type="checkbox"/> 	<input type="checkbox"/> 	<input type="checkbox"/> 	<input type="checkbox"/> 	<input type="checkbox"/> 	<input checked="" type="checkbox"/> 	<input checked="" type="checkbox"/> 	<input type="checkbox"/> 	<input type="checkbox"/> 	<input type="checkbox"/> 	<input type="checkbox"/> 	<input type="checkbox"/> 	<input type="checkbox"/> 	<input type="checkbox"/> 	<input checked="" type="checkbox"/> 	<input checked="" type="checkbox"/> 	<input type="checkbox"/> 
<input checked="" type="checkbox"/> or: 	<input type="checkbox"/> 	<input type="checkbox"/> 	<input type="checkbox"/> 	<input type="checkbox"/> 	<input type="checkbox"/> 	<input type="checkbox"/> 	<input type="checkbox"/> 	<input checked="" type="checkbox"/> 	<input checked="" type="checkbox"/> 													
<input type="checkbox"/> 	<input type="checkbox"/> 	<input type="checkbox"/> 	<input type="checkbox"/> 	<input type="checkbox"/> 	<input type="checkbox"/> 	<input type="checkbox"/> 	<input checked="" type="checkbox"/> 	<input checked="" type="checkbox"/> 	<input type="checkbox"/> 													

**Cable**

Kind of construction	SJT3X18AWG																					
Manufacturer / Type	<b>Feller</b>																					
Ratings																						
Required approval marks / certificates	<table border="1"> <tr> <td><input type="checkbox"/> or: </td> <td><input type="checkbox"/> </td> <td><input type="checkbox"/> </td> <td><input type="checkbox"/> </td> <td><input type="checkbox"/> </td> <td><input type="checkbox"/> </td> <td><input type="checkbox"/> </td> <td><input type="checkbox"/> </td> <td><input checked="" type="checkbox"/> </td> <td><input checked="" type="checkbox"/> </td> </tr> <tr> <td><input type="checkbox"/> </td> <td><input type="checkbox"/> </td> <td><input type="checkbox"/> </td> <td><input type="checkbox"/> </td> <td><input type="checkbox"/> </td> <td><input type="checkbox"/> </td> <td><input type="checkbox"/> </td> <td><input type="checkbox"/> </td> <td><input type="checkbox"/> </td> <td><input type="checkbox"/> </td> </tr> </table>		<input type="checkbox"/> or: 	<input type="checkbox"/> 	<input type="checkbox"/> 	<input type="checkbox"/> 	<input type="checkbox"/> 	<input type="checkbox"/> 	<input type="checkbox"/> 	<input type="checkbox"/> 	<input checked="" type="checkbox"/> 	<input checked="" type="checkbox"/> 	<input type="checkbox"/> 	<input type="checkbox"/> 	<input type="checkbox"/> 	<input type="checkbox"/> 	<input type="checkbox"/> 	<input type="checkbox"/> 	<input type="checkbox"/> 	<input type="checkbox"/> 	<input type="checkbox"/> 	<input type="checkbox"/> 
<input type="checkbox"/> or: 	<input type="checkbox"/> 	<input type="checkbox"/> 	<input type="checkbox"/> 	<input type="checkbox"/> 	<input type="checkbox"/> 	<input type="checkbox"/> 	<input type="checkbox"/> 	<input checked="" type="checkbox"/> 	<input checked="" type="checkbox"/> 													
<input type="checkbox"/> 	<input type="checkbox"/> 	<input type="checkbox"/> 	<input type="checkbox"/> 	<input type="checkbox"/> 	<input type="checkbox"/> 	<input type="checkbox"/> 	<input type="checkbox"/> 	<input type="checkbox"/> 	<input type="checkbox"/> 													

03					
02	10.12.2012	S.Dietrich			Schurter power cord is no longer available
01	22.03.2010	J. Popp			
00	22.03.2010	J. Popp			

Rev	DATE	DRWN.BY	CHKD.BY	E D V	MODIFICATION / DESCRIPTION
-----	------	---------	---------	-------	----------------------------

2922-0002-0034 Rev.01	DRGW. TITLE	 <b>CONRAC</b> High Performance Displays DRAWING NUMBER ..... .. <b>2215-1140-2500</b>
	<b>Power Cord Set North America Type</b>	
	SIZE ISO A 4	SHEET 1 OF 1



ALL TECHNOLOGIES. ALL COMPETENCIES. ONE SPECIALIST.



DATA MODUL AG  
Landsberger Straße 322 DE-  
80687 Munich  
Phone: +49-89-56017-0

DATA MODUL WEIKERSHEIM GMBH  
Lindenstraße 8  
DE-97990 Weikersheim Phone:  
+49-7934-101-0



More information and worldwide locations can be found at

[www.data-modul.com](http://www.data-modul.com)