

F
E
D
C
B
A

F
E
D
C
B
A

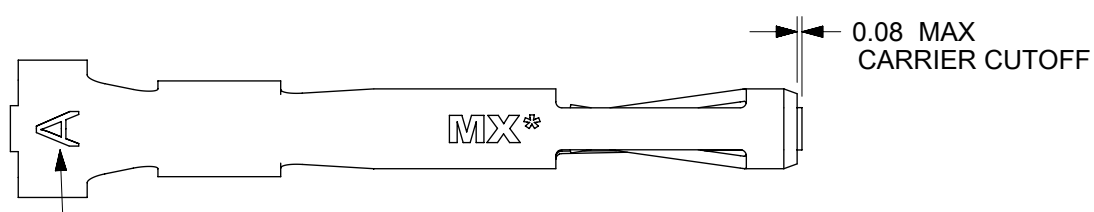

TERMINALS STAMPED WITH THE LETTER "A"
ACCEPT 24-30 AWG WIRE WITH A 1.52 MAX INSULATION DIA.

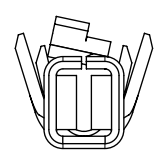
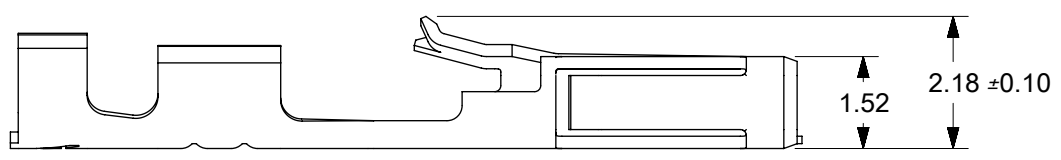
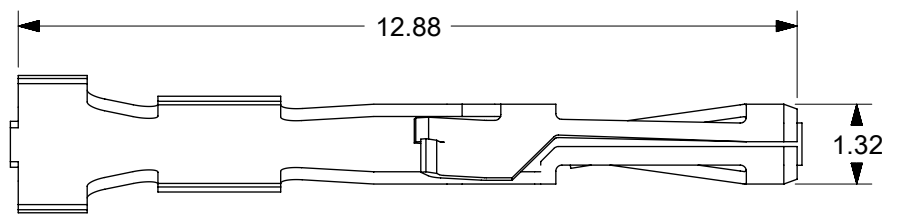
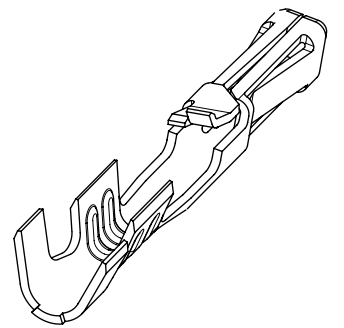

NOTES:

- MATERIAL: PHOSPHOR BRONZE
- PLATING:
 - 124 = SELECT BRIGHT TIN: 3.75 MICROMETERS MIN OVER NICKEL
 - 207 = SELECT HARD GOLD: 0.38 MICROMETERS MIN.
SELECT TIN: 2.0 MICROMETERS MIN BOTH OVER NICKEL
 - 206 = SELECT HARD GOLD: 0.75 MICROMETERS MIN.
SELECT TIN: 2.0 MICROMETERS MIN BOTH OVER NICKEL
 - 216 = SELECT HARD GOLD: 1.27 MICROMETERS MIN.
SELECT TIN: 2.54 MICROMETERS MIN BOTH OVER NICKEL
 - P124 = PREPLATED OVERALL BRIGHT TIN: 3.75 MICROMETERS MIN OVER NICKEL
(MAY HAVE UNPLATED EDGES)
- PRODUCT SPECIFICATION: TERMINALS CONFORM TO PS-70058 AND PS-70400 WHEN CRIMPED WITH MOLEX CRIMP TOOLS.
- COSMETIC SPECIFICATION: PS-45499-002 CLASS B
- TERMINAL FOR USE WITH HOUSING SERIES 70066 AND 70450
- WIRE SPECIFICATION: TERMINALS STAMPED WITH THE LETTER:
 - A = ACCEPTS 24-30 AWG STRANDED WIRE WITH A 1.52 MAX INSULATION DIA
 - B = ACCEPTS 32-36 AWG STRANDED WIRE WITH A 0.64 MAX INSULATION DIA.
 - C = ACCEPTS 22-24 AWG STRANDED WIRE WITH A 1.63 MAX INSULATION DIA

CURRENT PART NUMBER	REPLACEMENT PART NUMBER	PACKAGING	PLATING SEE NOTE 2	WIRE SIZE	MAX INSULATION DIA
16-02-0069	70058-1069	REEL	124 SELECT TIN	24-30 AWG	1.52 DIA MAX
16-02-0096	70058-1096	LOOSE			
70058-4069	70058-0069	REEL	P124 OVERALL TIN		
70058-4096	70058-0096	LOOSE			
16-02-0082	70058-0082	REEL	207 0.38 GOLD		
16-02-0097	70058-0097	LOOSE			
16-02-0083	70058-0083	REEL	206 0.75 GOLD		
16-02-0098	70058-0098	LOOSE			
16-02-0139	70058-0139	REEL	216 1.27 GOLD		
16-02-0140	70058-0140	LOOSE			

TERMINALS ON THIS SHEET ARE FOR USE
WITH 24-30 AWG WIRE.
SEE SHEETS 2 AND 3 FOR OTHER WIRE SIZES

SYMBOLS		THIS DRAWING CONTAINS INFORMATION THAT IS PROPRIETARY TO MOLEX ELECTRONIC TECHNOLOGIES, LLC AND SHOULD NOT BE USED WITHOUT WRITTEN PERMISSION			
▽ = 0	DIMENSION UNITS: mm	SCALE: 8:1	CURRENT REV DESC: ADD +/- .10 TO 2.18		
▽ = 0	GENERAL TOLERANCES (UNLESS SPECIFIED)		EC NO: 600382	SL CRIMP TERMINAL (24-30 AWG WIRE) PRODUCT CUSTOMER DRAWING	
▽ = 0	ANGULAR TOL ± °		DRWN: KSAMIEC 2018/04/10		
▽ = 0	4 PLACES ±		CHK'D: MKIPPER 2018/06/08		
▽ = 0	3 PLACES ±		APPR: FSMITH 2018/06/11	DOCUMENT NUMBER: 700580000-SD DOC TYPE: PSD DOC PART: 000 REVISION: A3	
▽ = 0	2 PLACES ± 0.25		INITIAL REVISION:		
▽ = 0	1 PLACE ± 0.15		DRWN: KSAMIEC 2017/05/03		
▽ = 0	0 PLACES ± 0.0		APPR: FSMITH 2017/06/16	MATERIAL NUMBER: SEE CHART CUSTOMER: GENERAL MARKET SHEET NUMBER: 1 OF 4	
■ = 0	DRAFT WHERE APPLICABLE MUST REMAIN WITHIN DIMENSIONS		THIRD ANGLE PROJECTION		
▽ = 0	DRAWING: B-SIZE		SERIES: 70058		

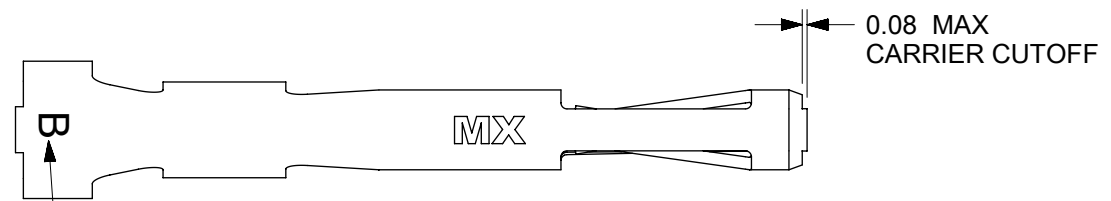
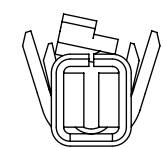
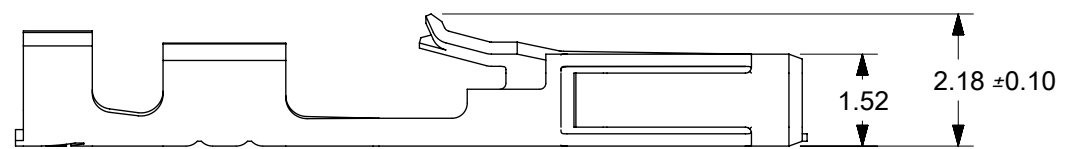
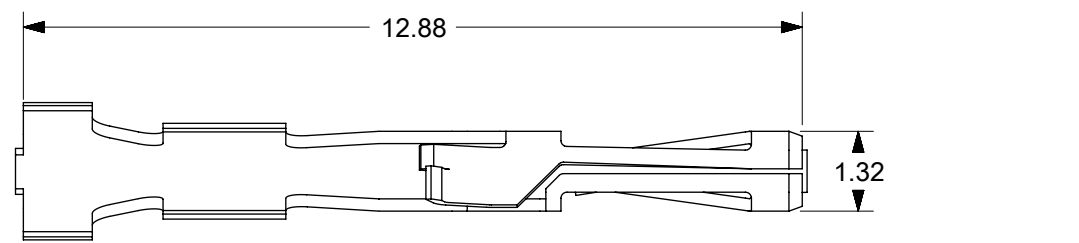

TERMINALS STAMPED WITH THE LETTER "B"
ACCEPT 32-36 AWG WIRE WITH A 0.64 MAX INSULATION DIA

- NOTES:
- MATERIAL: PHOSPHOR BRONZE
 - PLATING:
 - 124 = SELECT BRIGHT TIN: 3.75 MICROMETERS MIN OVER NICKEL
 - 207 = SELECT HARD GOLD: 0.38 MICROMETERS MIN.
SELECT TIN: 2.0 MICROMETERS MIN BOTH OVER NICKEL
 - 206 = SELECT HARD GOLD: 0.75 MICROMETERS MIN.
SELECT TIN: 2.0 MICROMETERS MIN BOTH OVER NICKEL
 - 216 = SELECT HARD GOLD: 1.27 MICROMETERS MIN.
SELECT TIN: 2.54 MICROMETERS MIN BOTH OVER NICKEL
 - P124 = PREPLATED OVERALL BRIGHT TIN: 3.75 MICROMETERS MIN OVER NICKEL
(MAY HAVE UNPLATED EDGES)
 - PRODUCT SPECIFICATION: TERMINALS CONFORM TO PS-70058 AND PS-70400 WHEN CRIMPED WITH MOLEX CRIMP TOOLS.
 - COSMETIC SPECIFICATION: PS-45499-002 CLASS B
 - TERMINAL FOR USE WITH HOUSING SERIES 70066 AND 70450
 - WIRE SPECIFICATION: TERMINALS STAMPED WITH THE LETTER:
 - A = ACCEPTS 24-30 AWG STRANDED WIRE WITH A 1.52 MAX INSULATION DIA
 - B = ACCEPTS 32-36 AWG STRANDED WIRE WITH A 0.64 MAX INSULATION DIA.
 - C = ACCEPTS 22-24 AWG STRANDED WIRE WITH A 1.63 MAX INSULATION DIA

CURRENT PART NUMBER	REPLACEMENT PART NUMBER	PACKAGING	PLATING SEE NOTE 2	WIRE SIZE	MAX INSULATION DIA
16-02-0084	70058-1084	REEL	124 SELECT TIN	32 - 36 AWG	0.64 DIA MAX
16-02-0099	70058-1099	LOOSE			
70058-4084	70058-0084	REEL	P124 OVERALL TIN		
70058-4099	70058-0099	LOOSE			
16-02-0074	70058-0074	REEL	207 0.38 GOLD		
16-02-0100	70058-0100	LOOSE			
16-02-0085	70058-0085	REEL	206 0.75 GOLD		
16-02-0101	70058-0101	LOOSE			
16-02-0143	70058-0143	REEL	216 1.27 GOLD		
16-02-0144	70058-0144	LOOSE			

TERMINALS ON THIS SHEET ARE FOR USE
WITH 32-36 AWG WIRE.
SEE SHEETS 1 AND 3 FOR OTHER WIRE SIZES

SYMBOLS		THIS DRAWING CONTAINS INFORMATION THAT IS PROPRIETARY TO MOLEX ELECTRONIC TECHNOLOGIES, LLC AND SHOULD NOT BE USED WITHOUT WRITTEN PERMISSION			
▽ = 0	DIMENSION UNITS	SCALE	CURRENT REV DESC: ADD +/- .10 TO 2.18		
▽ = 0	mm	8:1	EC NO: 600382	PRODUCT CUSTOMER DRAWING	
▽ = 0	GENERAL TOLERANCES (UNLESS SPECIFIED)		DRWN: KSAMIEC 2018/04/10	DOCUMENT NUMBER	
▽ = 0	ANGULAR TOL ± °		CHK'D: MKIPPER 2018/06/08	DOC TYPE DOC PART REVISION	
▽ = 0	4 PLACES ±		APPR: FSMITH 2018/06/11	700580000-SD PSD 000 A3	
▽ = 0	3 PLACES ±		INITIAL REVISION:	MATERIAL NUMBER	
▽ = 0	2 PLACES ± 0.25		DRWN: KSAMIEC 2017/05/03	CUSTOMER	
▽ = 0	1 PLACE ± 0.15		APPR: FSMITH 2017/06/16	SERIES	
▽ = 0	0 PLACES ± 0.0		DRAFT WHERE APPLICABLE MUST REMAIN WITHIN DIMENSIONS	THIRD ANGLE PROJECTION	
▽ = 0	DRAFT WHERE APPLICABLE MUST REMAIN WITHIN DIMENSIONS		DRIVING	SHEET NUMBER	
▽ = 0			B-SIZE	70058	
▽ = 0			SEE CHART	GENERAL MARKET	
▽ = 0				2 OF 4	

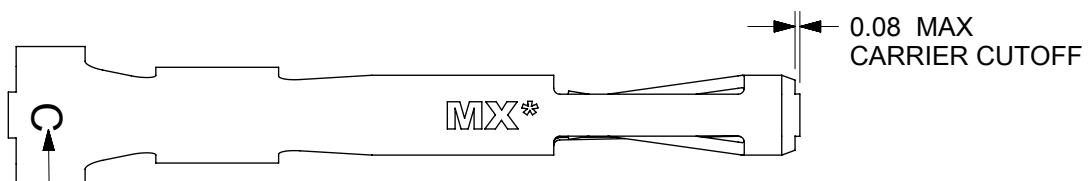
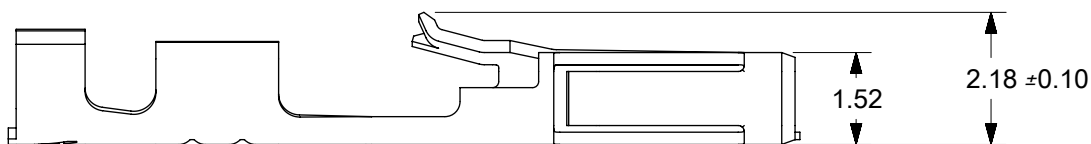
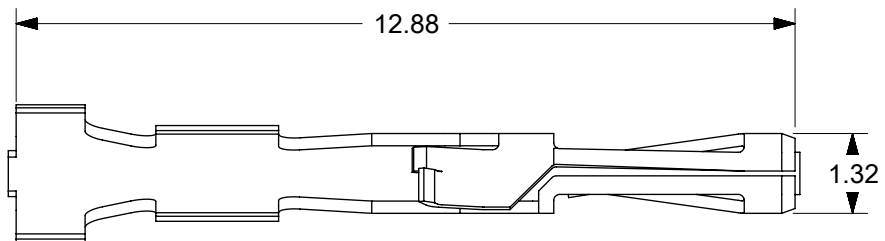

TERMINALS STAMPED WITH THE LETTER "C"
ACCEPT 22-24 AWG WIRE WITH A 1.63 MAX INSULATION DIA

NOTES:

- MATERIAL: PHOSPHOR BRONZE
- PLATING:
 - 124 = SELECT BRIGHT TIN: 3.75 MICROMETERS MIN OVER NICKEL
 - 207 = SELECT HARD GOLD: 0.38 MICROMETERS MIN.
SELECT TIN: 2.0 MICROMETERS MIN BOTH OVER NICKEL
 - 206 = SELECT HARD GOLD: 0.75 MICROMETERS MIN.
SELECT TIN: 2.0 MICROMETERS MIN BOTH OVER NICKEL
 - 216 = SELECT HARD GOLD: 1.27 MICROMETERS MIN.
SELECT TIN: 2.54 MICROMETERS MIN BOTH OVER NICKEL
 - P124 = PREPLATED OVERALL BRIGHT TIN: 3.75 MICROMETERS MIN OVER NICKEL
(MAY HAVE UNPLATED EDGES)
- PRODUCT SPECIFICATION: TERMINALS CONFORM TO PS-70058 AND PS-70400 WHEN CRIMPED WITH MOLEX CRIMP TOOLS.
- COSMETIC SPECIFICATION: PS-45499-002 CLASS B
- TERMINAL FOR USE WITH HOUSING SERIES 70066 AND 70450
- WIRE SPECIFICATION: TERMINALS STAMPED WITH THE LETTER:
 - A = ACCEPTS 24-30 AWG STRANDED WIRE WITH A 1.52 MAX INSULATION DIA
 - B = ACCEPTS 32-36 AWG STRANDED WIRE WITH A 0.64 MAX INSULATION DIA.
 - C = ACCEPTS 22-24 AWG STRANDED WIRE WITH A 1.63 MAX INSULATION DIA

CURRENT PART NUMBER	REPLACEMENT PART NUMBER	PACKAGING	PLATING SEE NOTE 2	WIRE SIZE	MAX INSULATION DIA
16-02-0086	70058-1086	REEL	124 SELECT TIN	22-24 AWG	1.63 DIA MAX
16-02-0102	70058-1102	LOOSE			
70058-4086	70058-0086	REEL	P124 OVERALL TIN		
70058-4102	70058-0102	LOOSE			
16-02-0087	70058-0087	REEL	207 0.38 GOLD		
16-02-0103	70058-0103	LOOSE			
16-02-0088	70058-0088	REEL	206 0.75 GOLD		
16-02-0104	70058-0104	LOOSE			
16-02-0131	70058-0131	REEL	216 1.27 GOLD		
16-02-0147	70058-0147	LOOSE			

TERMINALS ON THIS SHEET ARE FOR USE
WITH 22-24 AWG WIRE.
SEE SHEETS 1 AND 2 FOR OTHER WIRE SIZES

SYMBOLS	THIS DRAWING CONTAINS INFORMATION THAT IS PROPRIETARY TO MOLEX ELECTRONIC TECHNOLOGIES, LLC AND SHOULD NOT BE USED WITHOUT WRITTEN PERMISSION				
	DIMENSION UNITS	SCALE			
▽ = 0	mm	8:1	EC NO: 600382		
▽ = 0	GENERAL TOLERANCES (UNLESS SPECIFIED)		DRWN: KSAMIEC 2018/04/10		
▽ = 0	ANGULAR TOL ± °		CHK'D: MKIPPER 2018/06/08		
▽ = 0	4 PLACES	±	APPR: FSMITH 2018/06/11		
▽ = 0	3 PLACES	±	INITIAL REVISION:		
▽ = 0	2 PLACES	± 0.25	DRWN: KSAMIEC 2017/05/03		
▽ = 0	1 PLACE	± 0.15	APPR: FSMITH 2017/06/16		
▽ = 0	0 PLACES	± 0.0	DRAFT WHERE APPLICABLE MUST REMAIN WITHIN DIMENSIONS		
▽ = 0	THIRD ANGLE PROJECTION		DRAWING	SERIES	MATERIAL NUMBER
▽ = 0			B-SIZE	70058	SEE CHART
			CUSTOMER	SHEET NUMBER	
			GENERAL MARKET	3 OF 4	

LOOSE PACKED

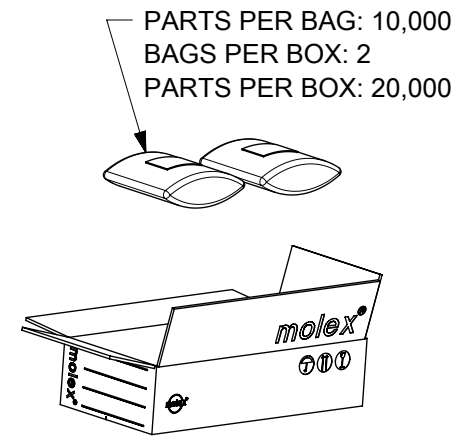

REEL PACKED

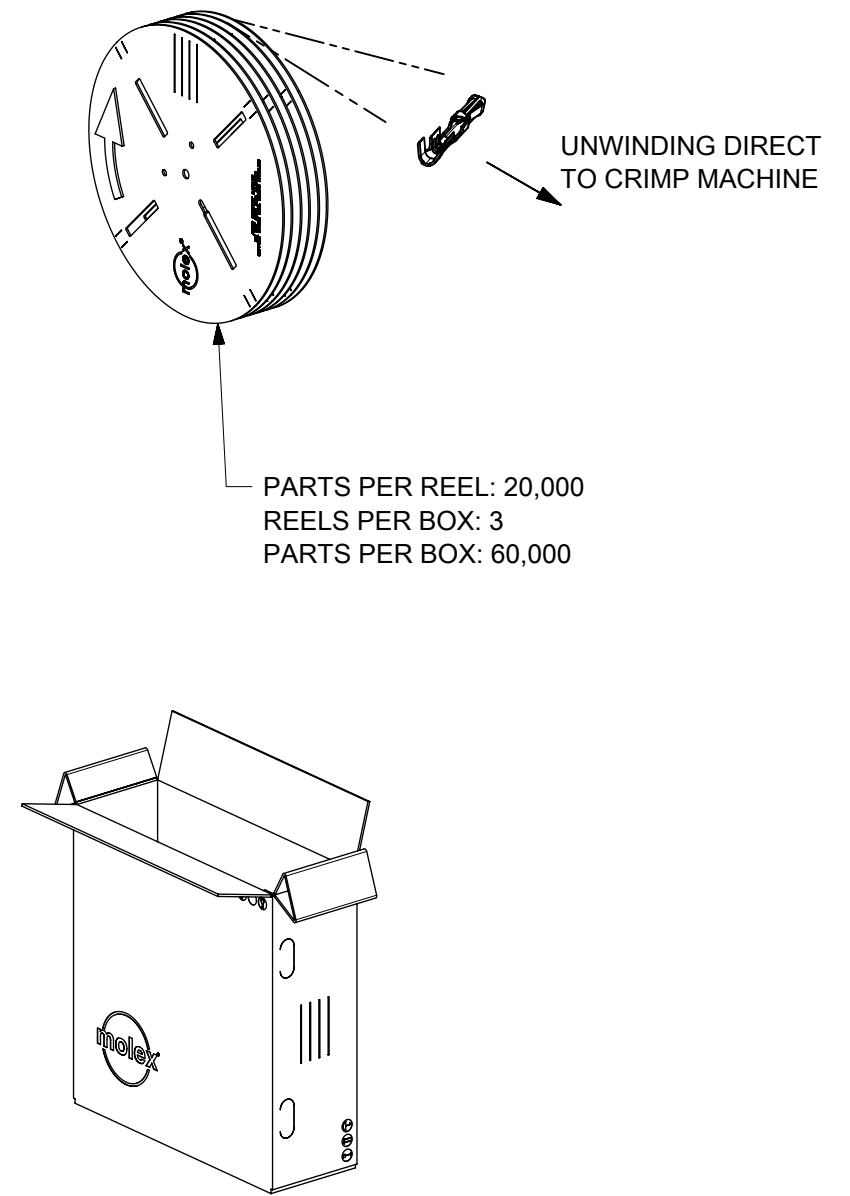

WHEN TERMINALS ARE FULLY INSERTED INTO THE HOUSINGS. THE TERMINAL'S LOCKING TANG SHOULD BE VISABLE IN THE HOUSING'S WINDOWS

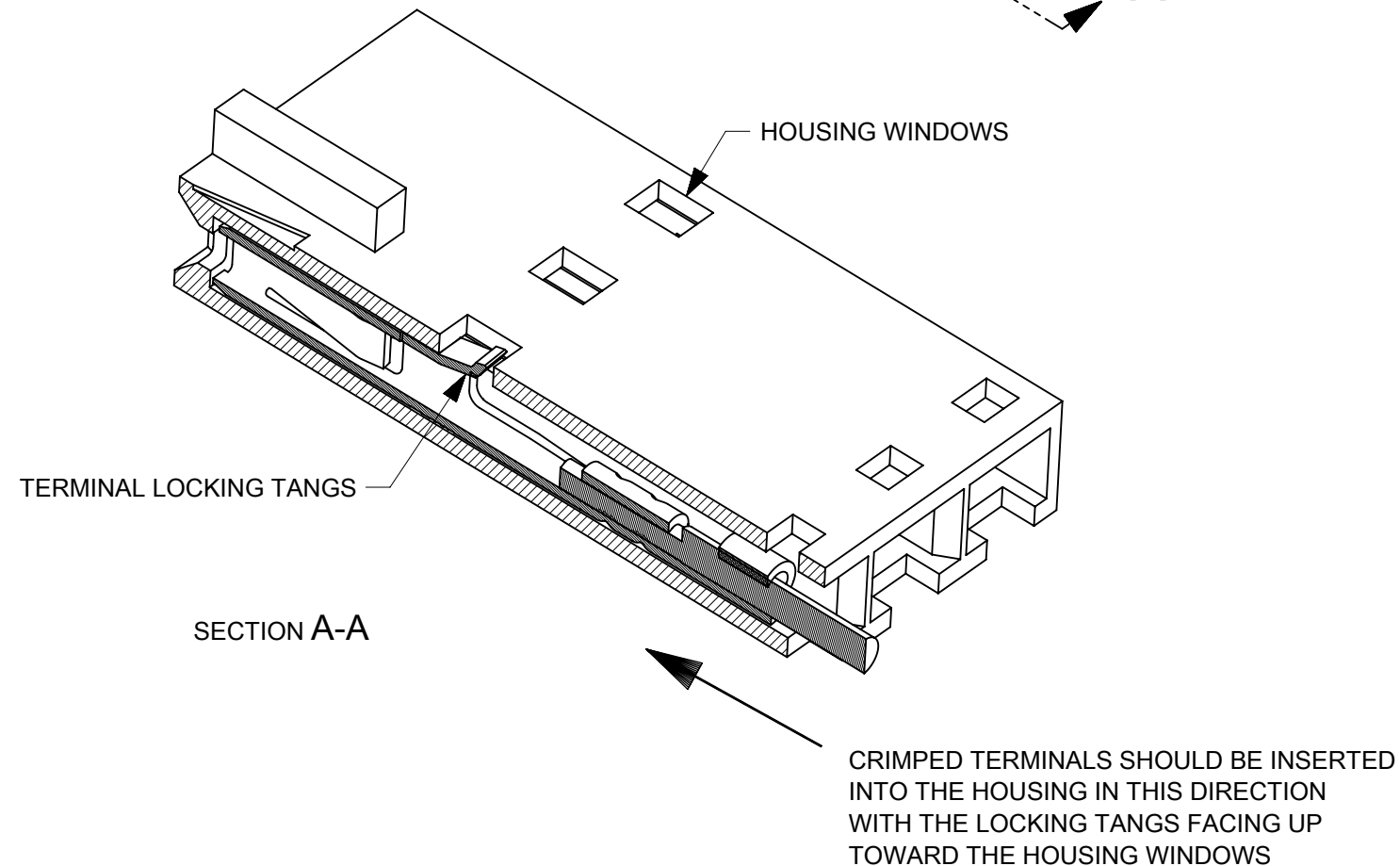
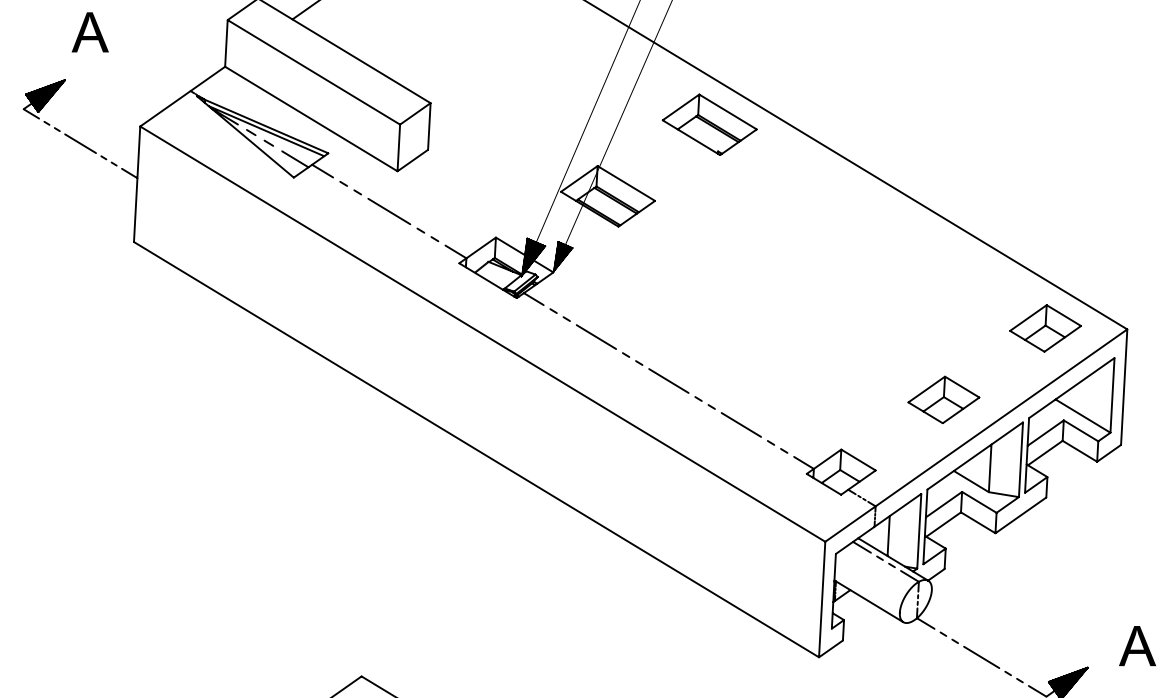

SYMBOLS										THIS DRAWING CONTAINS INFORMATION THAT IS PROPRIETARY TO MOLEX ELECTRONIC TECHNOLOGIES, LLC AND SHOULD NOT BE USED WITHOUT WRITTEN PERMISSION									
DIMENSION UNITS		SCALE		CURRENT REV DESC: ADD +/- .10 TO 2.18															
mm		1:15		GENERAL TOLERANCES (UNLESS SPECIFIED)															
▽ = 0	4 PLACES	±	°	EC NO: 600382										DOCUMENT NUMBER					
▽ = 0	3 PLACES	±		DRWN: KSAMIEC 2018/04/10										700580000-SD					
▽ = 0	2 PLACES	±	0.25	CHK'D: MKIPPER 2018/06/08										PSD 000 A3					
▽ = 0	1 PLACE	±	0.15	APPR: FSMITH 2018/06/11										REVISION					
▽ = 0	0 PLACES	±	0.0	INITIAL REVISION:										MATERIAL NUMBER					
▽ = 0	DRAFT WHERE APPLICABLE MUST REMAIN WITHIN DIMENSIONS			THIRD ANGLE PROJECTION		DRAWING		SERIES		CUSTOMER		SHEET NUMBER							
▽ = 0				B-SIZE		70058		GENERAL MARKET		4 OF 4									