

ROM46A-1-C

Aruba Networks® ROM46A-1 Compatible TAA Compliant 50GBase-CU SFP56 to SFP56 Direct Attach Cable (Passive Twinax, 1m)

Features

- Compliant with SFP56 MSA Specification
- Electrical interface specifications per SFF-8431
- Management interface specifications per SFF-8472
- Supports 56Gbps
- 30AWG Wire Gauge
- 1m Length
- PAM4 modulation
- Cable Color: Black
- I2C for EEPROM communication
- ROHS Compliant



Applications

- Servers
- Switches
- Routers
- Data Centers
- High Performance Computing

Product Description

This is an Aruba Networks® ROM46A-1 compatible 50GBase-CU SFP56 to SFP56 direct attach cable that operates over passive copper with a maximum reach of 1.0m (3.3ft). It has been programmed, uniquely serialized, and data-traffic and application tested to ensure it is 100% compliant and functional. This direct attach cable is TAA (Trade Agreements Act) compliant, and is built to comply with MSA (Multi-Source Agreement) standards. We stand behind the quality of our products and proudly offer a limited lifetime warranty.

ProLabs' direct attach cables are RoHS compliant and lead-free.

TAA refers to the Trade Agreements Act (19 U.S.C. & 2501-2581), which is intended to foster fair and open international trade. TAA requires that the U.S. Government may acquire only "U.S. – made or designated country end products."



Regulatory Compliance

- ESD to the Electrical PINs: compatible with MIL-STD-883E Method 3015.4
- ESD to the LC Receptacle: compatible with IEC 61000-4-3
- EMI/EMC compatible with FCC Part 15 Subpart B Rules, EN55022:2010
- Laser Eye Safety compatible with FDA 21CFR, EN60950-1& EN (IEC) 60825-1,2
- RoHS compliant with EU RoHS 2.0 directive 2015/863/EU

Characteristics

Parameter	Specification
Data Rate	56Gb/s
Assembly Color	Black
Number of Pluggable I/O Cable Assembly Positions	2-Pair
Number of Signal Positions	4
Cable Assembly Category	High Speed

Cable Specifications

Length	Tolerance	Wire Gauge
1m (3.3ft)	±30mm	30AWG

SFP56 Pin Definitions

Pin	Symbol	Name/Descriptions	Notes
1	VeeT	Transmitter Ground	1
2	TX_Fault	Transmitter Fault (LVTTTL-O) - High indicates a fault condition	2
3	TX_Disable	Transmitter Disable (LVTTTL-I) – High or open disables the transmitter	3
4	SDA	Two wire serial interface Data Line (LVCMOS-I/O) (MOD-DEF2)	4
5	SCL	Two wire serial interface Clock Line (LVCMOS-I/O) (MOD-DEF1)	4
6	MOD_ABS	Module Absent (Output), connected to VeeT or VeeR in the module	5
7	RS0	NA	6
8	RX_LOS	Receiver Loss of Signal (LVTTTL-O)	2
9	RS1	NA	6
10	VeeR	Receiver Ground	1
11	VeeR	Receiver Ground	1
12	RD-	Inverse Received Data out (CML-O)	
13	RD+	Received Data out (CML-O)	
14	VeeR	Receiver Ground	
15	VccR	Receiver Power - +3.3V	
16	VccT	Transmitter Power - +3.3 V	
17	VeeT	Transmitter Ground	1
18	TD+	Transmitter Data In (CML-I)	
19	TD-	Inverse Transmitter Data In (CML-I)	
20	VeeT	Transmitter Ground	1

Notes:

1. The module signal grounds are isolated from the module case.
2. This is an open collector/drain output that on the host board requires a 4.7KΩ to 10KΩ pull-up resistor to Vcc-Host.
3. This input is internally biased high with a 4.7KΩ to 10KΩ pull-up resistor to VccT.
4. Two-Wire Serial interface clock and data lines require an external pull-up resistor.
5. This is a ground return that on the host board requires a 4.7KΩ to 10KΩ pull-up resistor to Vcc-Host.
6. Rate select not available

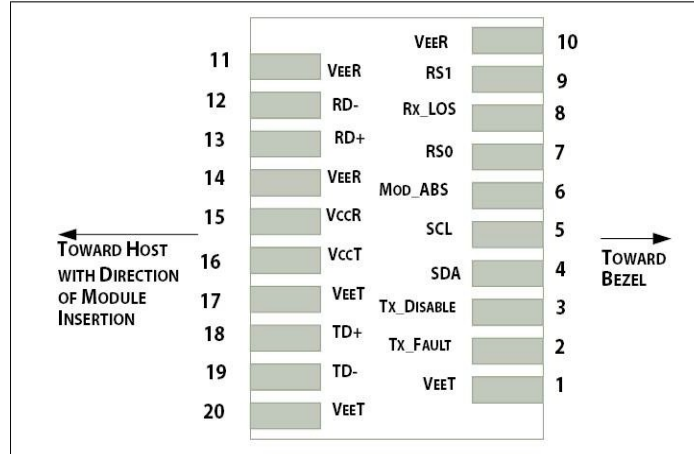

Host PCB SFP56 Pad Assignment Top View

Wiring Schematic

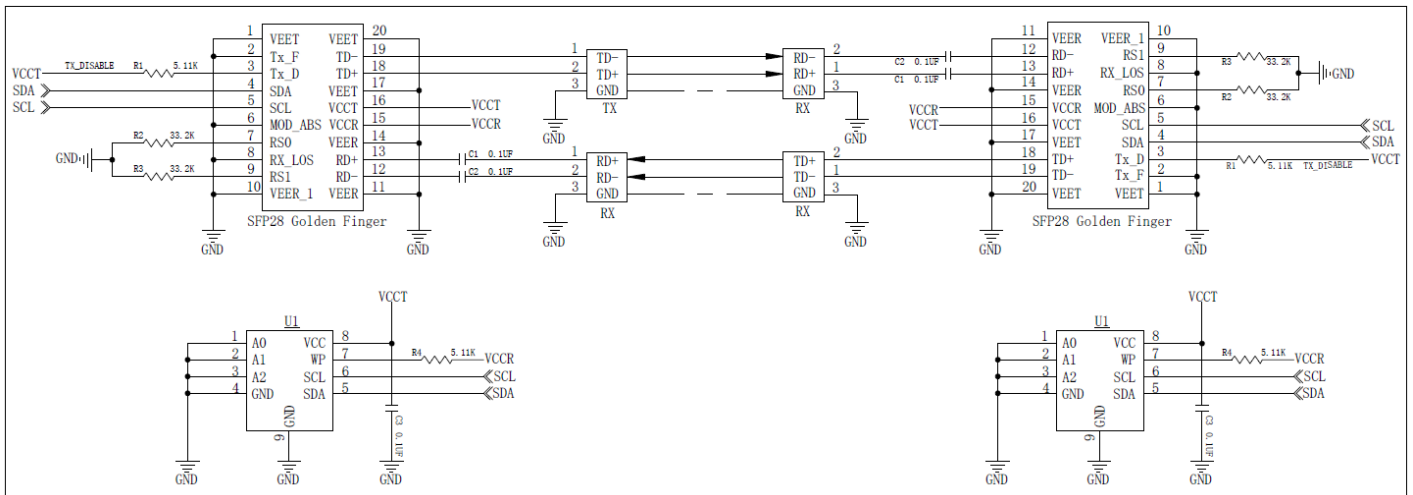

Mechanical Specifications

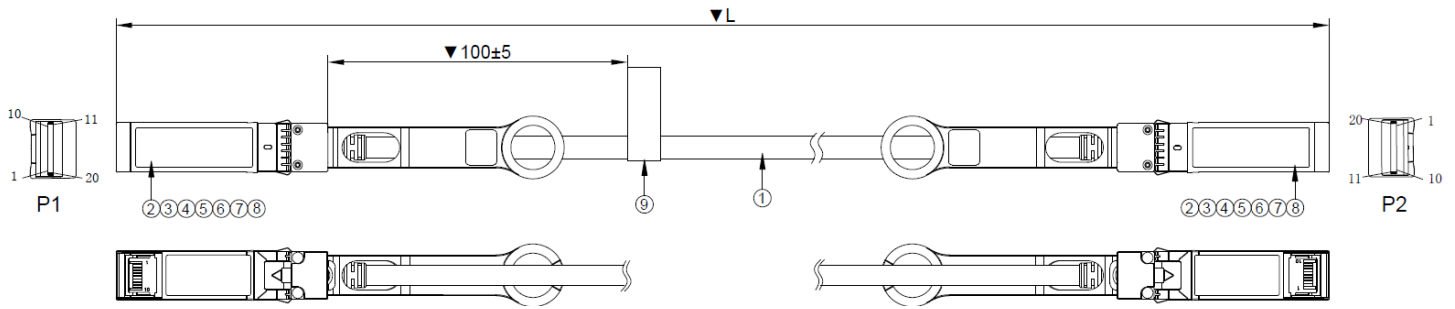

No.	Description	Quantity	Unit
1	SFP56 Cable, 30AWG, Black, RoHS 2.0	A/R	M
2	SFP56 Connector Shell	2	PCS
3	SFP28 25G PCBA, MCU	2	PCS
4	Pull Tab (Black, with logo)	2	PCS
5	SR (Black PVC)	A/R	KG
6	Resin, Black	A/R	KG
7	Heat-Resistant Tape	A/R	M
8	W=5mm Copper Foil	A/R	M
9	Label	1	PCS

About ProLabs

Our experience comes as standard; for over 15 years ProLabs has delivered optical connectivity solutions that give our customers freedom and choice through our ability to provide seamless interoperability. At the heart of our company is the ability to provide state-of-the-art optical transport and connectivity solutions that are compatible with over 90 optical switching and transport platforms.

Complete Portfolio of Network Solutions

ProLabs is focused on innovations in optical transport and connectivity. The combination of our knowledge of optics and networking equipment enables ProLabs to be your single source for optical transport and connectivity solutions from 100Mb to 400G while providing innovative solutions that increase network efficiency. We provide the optical connectivity expertise that is compatible with and enhances your switching and transport equipment.

Trusted Partner

Customer service is our number one value. ProLabs has invested in people, labs and manufacturing capacity to ensure that you get immediate answers to your questions and compatible product when needed. With Engineering and Manufacturing offices in the U.K. and U.S. augmented by field offices throughout the U.S., U.K. and Asia, ProLabs is able to be our customers best advocate 24 hours a day.

Contact Information

ProLabs US

Email: sales@prolabs.com

Telephone: 952-852-0252

ProLabs UK

Email: salessupport@prolabs.com

Telephone: +44 1285 719 600