

## Sensor/actuator cable - SAC-12P-MS/ 3,0-PUR SCO - 1430543

Please be informed that the data shown in this PDF Document is generated from our Online Catalog. Please find the complete data in the user's documentation. Our General Terms of Use for Downloads are valid (<http://phoenixcontact.com/download>)



Sensor/actuator cable, 12-position, PUR halogen-free, black RAL 9005, Plug straight M12 SPEEDCON, A-coded, on free cable end, cable length: 3 m

### Your advantages

- ✓ Easy and safe: 100% electrically tested plug-in components
- ✓ Save time, thanks to installation with SPEEDCON fast locking system
- ✓ Our standard: robust halogen-free PUR cable
- ✓ Save space – with high-pos. connectors



### Key Commercial Data

Packing unit	1 pc
GTIN	 4 046356 456364
GTIN	4046356456364

### Technical data

#### Dimensions

Length of cable	3 m
Stripping length of the free conductor end	35 mm

#### Ambient conditions

Ambient temperature (operation)	-25 °C ... 85 °C (Plug / socket)
Degree of protection	IP65/IP68/IP69K

#### General

Rated current at 40°C	1.5 A
Rated voltage	30 V AC
	30 V DC
Number of positions	12
Insulation resistance	≥ 100 MΩ

# Sensor/actuator cable - SAC-12P-MS/ 3,0-PUR SCO - 1430543

## Technical data

### General

Coding	A - standard
Standards/regulations	M12 connector IEC 61076-2-101
Status display	No
Protective circuit/component	unwired
Overvoltage category	II
Degree of pollution	3
Torque	0.4 Nm (M12 connector)

### Material

Flammability rating according to UL 94	V0
Contact material	CuZn
Contact surface material	Ni/Au
Contact carrier material	PA 6.6
Material of grip body	TPU, hardly inflammable, self-extinguishing
Material, knurls	Zinc die-cast, nickel-plated

### Standards and Regulations

Standard designation	M12 connector
Standards/regulations	IEC 61076-2-101
Resistance to oil	DIN VDE 0472 Part 803, test type B
Other resistance	Hydrolysis and microbe resistant as per VDE 0282 section 10
Flammability rating according to UL 94	V0

### Cable

Conductor cross section	12x 0.14 mm <sup>2</sup> (Signal line)
AWG signal line	26
Conductor structure signal line	18x 0.10 mm
Core diameter including insulation	1 mm ±0.05 mm (Signal line)
Wire colors	white, brown, green, yellow, gray, pink, blue, red, black, violet, gray/pink, red/blue
Overall twist	12 wires twisted in layers
External sheath, color	black RAL 9005
External cable diameter D	7.2 mm
Number of bending cycles	4000000
Bending radius	54 mm
Traversing path	10 m
Traversing rate	3 m/s
Acceleration	10 m/s <sup>2</sup>
Outer sheath, material	PUR
Material conductor insulation	PP
Conductor material	Tin-plated Cu litz wires
Conductor resistance	142 Ω/km
Special properties	Low adhesion surface

## Sensor/actuator cable - SAC-12P-MS/ 3,0-PUR SCO - 1430543

### Technical data

#### Cable

Flame resistance	in acc. to UL VW1
	DIN EN 60332-1-2
Halogen-free	in accordance with DIN EN 50267-2-1
Resistance to oil	DIN VDE 0472 Part 803, test type B
Other resistance	Hydrolysis and microbe resistant as per VDE 0282 section 10
	partly UV-resistant in accordance with DIN EN ISO 4892-2-A
Ambient temperature (operation)	-40 °C ... 80 °C (cable, fixed installation)
	-5 °C ... 80 °C (cable, flexible installation)

#### Environmental Product Compliance

REACH SVHC	Lead 7439-92-1
China RoHS	Environmentally Friendly Use Period = 50
	For details about hazardous substances go to tab "Downloads", Category "Manufacturer's declaration"

#### Drawings

# Sensor/actuator cable - SAC-12P-MS/ 3,0-PUR SCO - 1430543

Schematic diagram

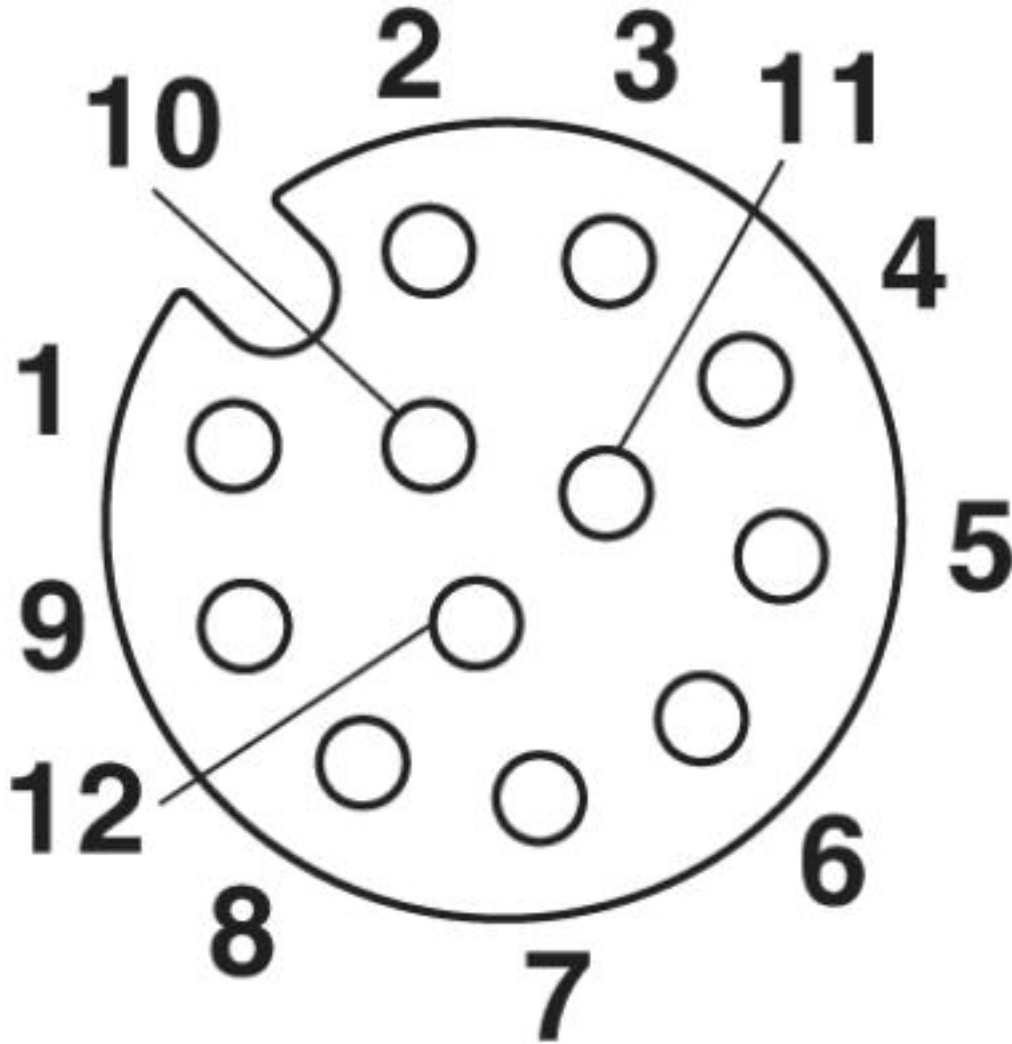

Pin assignment M12, 12-pos., female side view

# Sensor/actuator cable - SAC-12P-MS/ 3,0-PUR SCO - 1430543

Schematic diagram

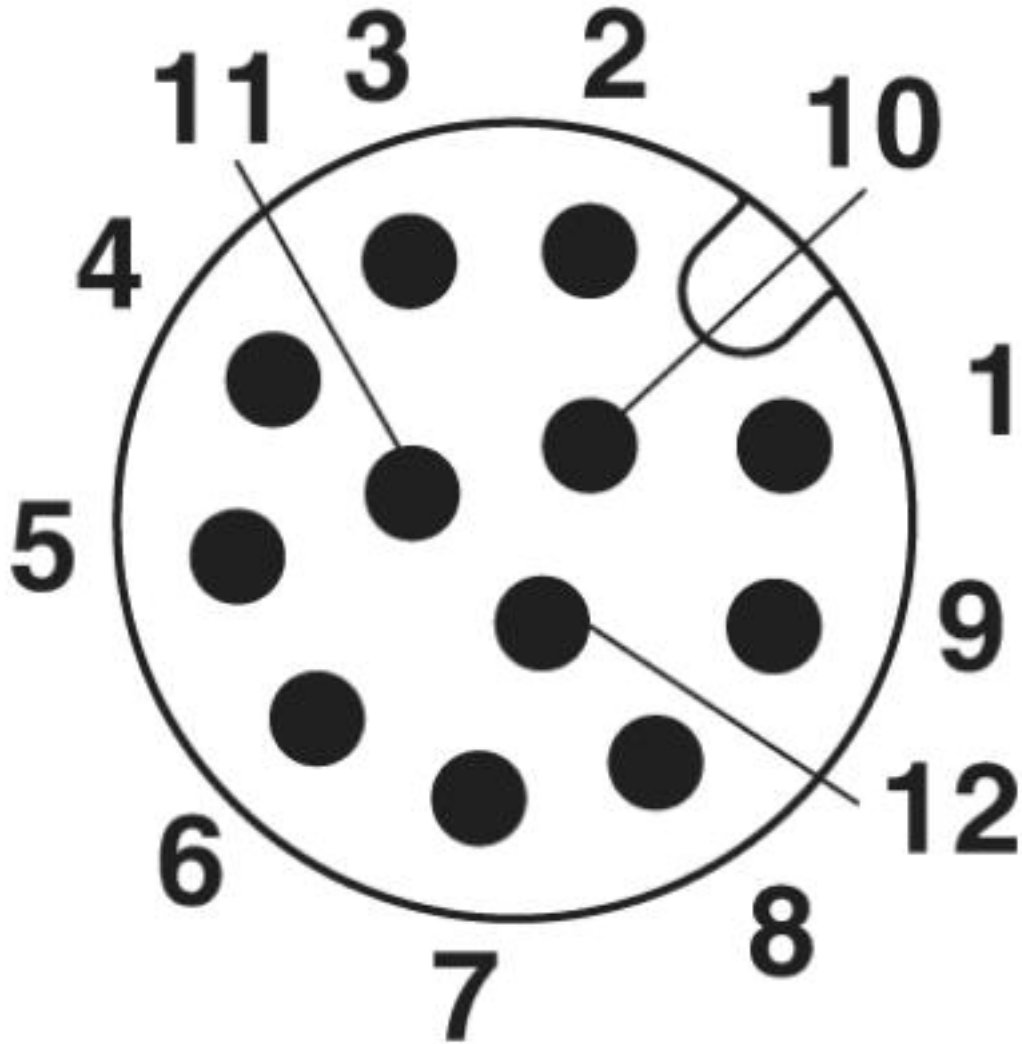

Pin assignment M12 male connector, 12-pos., male side view

# Sensor/actuator cable - SAC-12P-MS/ 3,0-PUR SCO - 1430543

Dimensional drawing

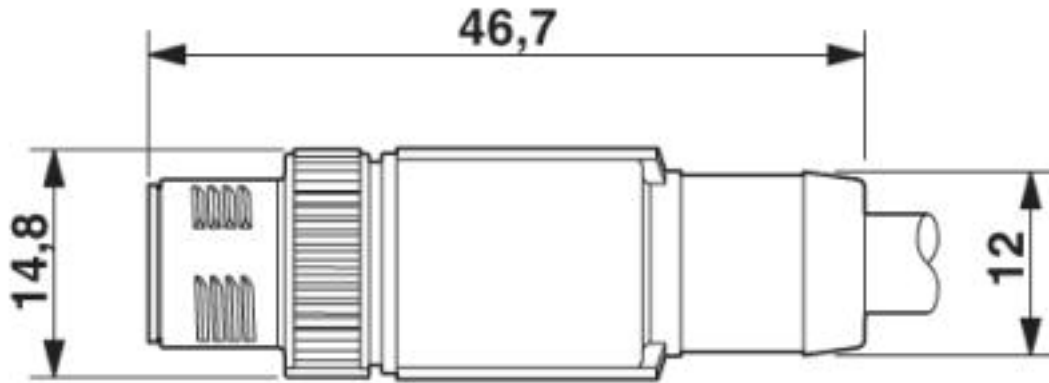

M12 SPEEDCON plug, straight

Circuit diagram

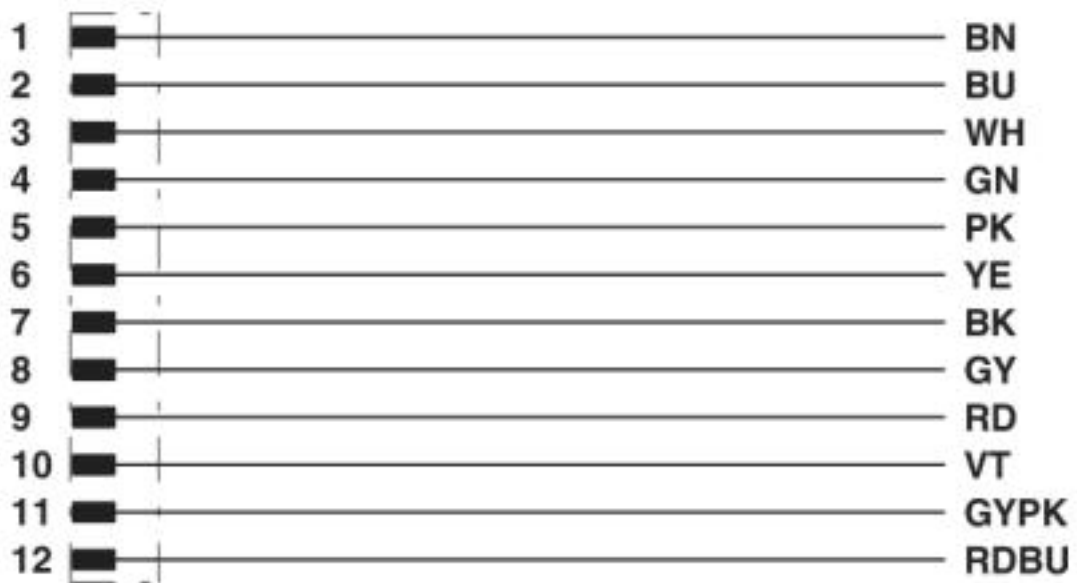

Contact assignment of the M12 plug

# Sensor/actuator cable - SAC-12P-MS/ 3,0-PUR SCO - 1430543

Cable cross section



PUR halogen-free black [PUR]

## Approvals

Approvals

---

Approvals

EAC / UL Listed

---

Ex Approvals

---

Approval details

# Sensor/actuator cable - SAC-12P-MS/ 3,0-PUR SCO - 1430543

## Approvals

EAC		RU C- DE.BL08.B.00286
-----	---	--------------------------

UL Listed		<a href="http://database.ul.com/cgi-bin/XYV/template/LISEXT/1FRAME/index.htm">http://database.ul.com/cgi-bin/XYV/template/LISEXT/1FRAME/index.htm</a>	FILE E 221474
-----------	---	---	---------------

Nominal voltage UN	30 V
Nominal current IN	1 A

Phoenix Contact 2019 © - all rights reserved  
<http://www.phoenixcontact.com>

PHOENIX CONTACT GmbH & Co. KG  
Flachsmarktstr. 8  
32825 Blomberg  
Germany  
Tel. +49 5235 300  
Fax +49 5235 3 41200  
<http://www.phoenixcontact.com>