

CARRIER TAPE SPEC FOR SMT SINGLE VERTICAL HEADER OF NANO-FIT					
CARRIER TAPE NUMBER	DIM A	DIM B	DIM D	DIM E	DIM F
105431-8001	24.00	N/A	11.50	8.63	6.97
105431-8002	24.00	N/A	11.50	11.13	9.47
105431-8003	32.00	28.40	14.20	13.63	11.97
105431-8004	32.00	28.40	14.20	16.13	14.47
105431-8005	44.00	40.40	20.20	18.63	16.97
105431-8006	44.00	40.40	20.20	21.13	19.47
105431-8007	44.00	40.40	20.20	23.63	21.97

NOTES :
1. REELING DIRECTION IN DELIVERY.

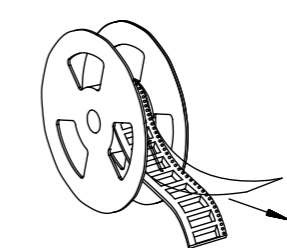

USER FEEDING DIRECTION



SECTION B-B

2. USER FEEDING DIRECTION

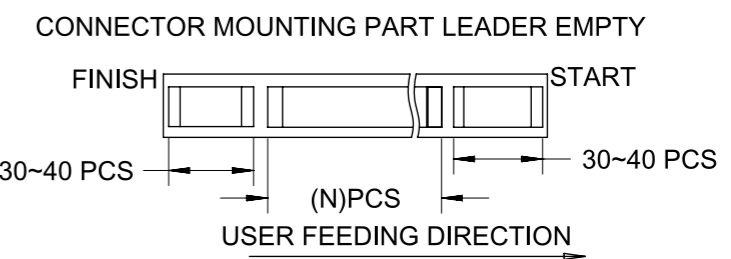

3. COVER TAPE PEELING FORCE

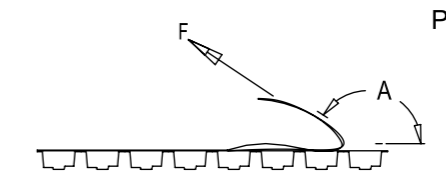

PEELING SPEED 300mm/Min.(REF.)

A	170°~180°
F	0.1N~1.3N

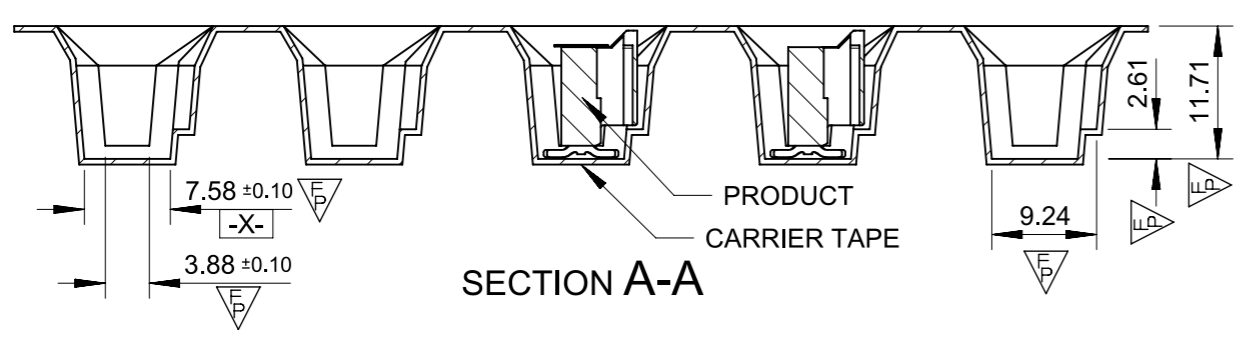

SECTION A-A

USER FEEDING DIRECTION →

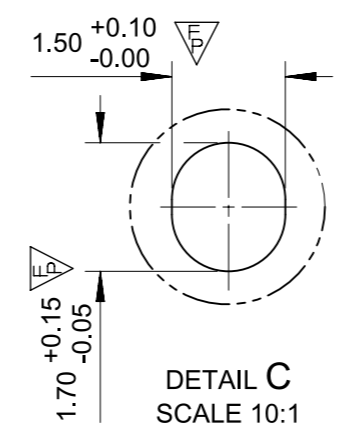

DETAIL C
SCALE 10:1

NANO-FIT CONNECTOR FULLY LOADED

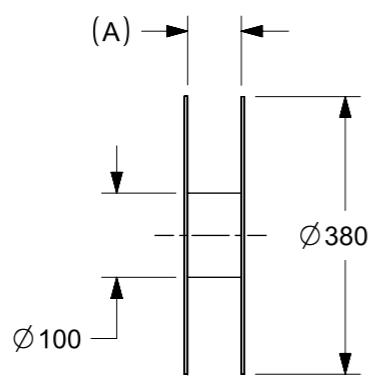
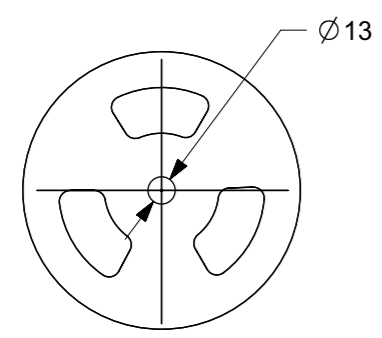
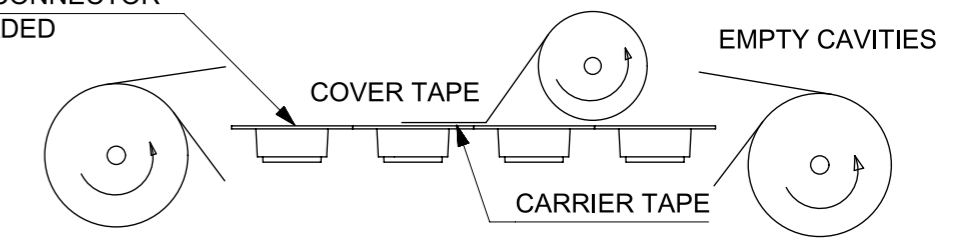

FUNCTIONAL SYMBOLS		THIS DRAWING CONTAINS INFORMATION THAT IS PROPRIETARY TO MOLEX ELECTRONIC TECHNOLOGIES, LLC AND SHOULD NOT BE USED WITHOUT WRITTEN PERMISSION		CURRENT REV DESC:		molex	
▽A = 0	mm	SCALE	1:1				
GENERAL TOLERANCES (UNLESS SPECIFIED)						PACKING DRAWING FOR NANO-FIT	
▽E = 0	ANGULAR TOL		±	°		PRODUCT CUSTOMER DRAWING	
▽F = 0	4 PLACES	±					DOCUMENT NUMBER
DIVISIONAL SYMBOLS		3 PLACES	±			1054311000-PK	
		2 PLACES	±	0.13			DOC TYPE
		1 PLACE	±	0.25			DOC PART
		0 PLACES	±				REVISION
DRAFT WHERE APPLICABLE MUST REMAIN WITHIN DIMENSIONS		THIRD ANGLE PROJECTION	DRAWING	SERIES	MATERIAL NUMBER	CUSTOMER	SHEET NUMBER
			A3-SIZE	105431		GENERAL MARKET	1 OF 2



REEL	COVER TAPE	CARRIER TAPE	PRODUCT NUMBER				PARTS PER REEL	REELS PER CARTON	PARTS PER CARTON		
885961399	894990121	105431-8001	WITH MYLAR	105431-1102, 105431-1202, 105431-1302, 105431-1402				300	3	900	
			WITHOUT MYLAR	105431-1502, 105431-1602, 105431-1702, 105431-1802							
			WITHOUT MYLAR	105431-2502, 105431-2602, 105431-2702, 105431-2802							
		105431-8002	WITH MYLAR	105431-1103, 105431-1203, 105431-1303, 105431-1403							
			WITHOUT MYLAR	105431-1503, 105431-1603, 105431-1703, 105431-1803							
			WITHOUT MYLAR	105431-2503, 105431-2603, 105431-2703, 105431-2803							
885961400	894990122	105431-8003	WITH MYLAR	105431-1104, 105431-1204, 105431-1304, 105431-1404				300	3	900	
			WITHOUT MYLAR	105431-1504, 105431-1604, 105431-1704, 105431-1804							
			WITHOUT MYLAR	105431-2504, 105431-2604, 105431-2704, 105431-2804							
		105431-8004	WITH MYLAR	105431-1105, 105431-1205, 105431-1305, 105431-1405							
			WITHOUT MYLAR	105431-1505, 105431-1605, 105431-1705, 105431-1805							
			WITHOUT MYLAR	105431-2505, 105431-2605, 105431-2705, 105431-2805							
885961401	894990123	105431-8005	WITH MYLAR	105431-1106, 105431-1206, 105431-1306, 105431-1406				300	2	600	
			WITHOUT MYLAR	105431-1506, 105431-1606, 105431-1706, 105431-1806							
			WITHOUT MYLAR	105431-2506, 105431-2606, 105431-2706, 105431-2806							
			105431-8006	WITH MYLAR	105431-1107, 105431-1207, 105431-1307, 105431-1407						
				WITHOUT MYLAR	105431-1507, 105431-1607, 105431-1707, 105431-1807						
				WITHOUT MYLAR	105431-2507, 105431-2607, 105431-2707, 105431-2807						
		105431-8007	WITH MYLAR	105431-1108, 105431-1208, 105431-1308, 105431-1408				300	2	600	
			WITHOUT MYLAR	105431-1508, 105431-1608, 105431-1708, 105431-1808							
			WITHOUT MYLAR	105431-2508, 105431-2608, 105431-2708, 105431-2808							

- NOTES :
1. STAPLES SHOULD ONLY BE USED TO SET UP CARTON. ALL CARTONS CLOSURES MUST BE DONE WITH TAPE.
 2. FILL PACKAGING BAGS WITH THE QUANTITIES AS INDICATED IN THE CHART



THIS DRAWING CONTAINS INFORMATION THAT IS PROPRIETARY TO MOLEX ELECTRONIC TECHNOLOGIES, LLC AND SHOULD NOT BE USED WITHOUT WRITTEN PERMISSION									
FUNCTIONAL SYMBOLS	DIMENSION UNITS	SCALE	CURRENT REV DESC:						
$\nabla_A = 0$	mm	1:1	molex PACKING DRAWING FOR NANO-FIT PRODUCT CUSTOMER DRAWING						
$\nabla_E = 0$	GENERAL TOLERANCES (UNLESS SPECIFIED)								
$\nabla_P = 0$	ANGULAR TOL	± °							
DIVISIONAL SYMBOLS	4 PLACES	±							
	3 PLACES	±	EC NO: 670810	2021/07/21					
	2 PLACES	± 0.13	DRWN: GLLI	2021/07/22					
	1 PLACE	± 0.25	CHK'D: YXZHENG	2021/07/22					
	0 PLACES	±	APPR: YXZHENG	2021/07/22					
DRAFT WHERE APPLICABLE MUST REMAIN WITHIN DIMENSIONS			THIRD ANGLE PROJECTION	DRAWING	SERIES	MATERIAL NUMBER	CUSTOMER	DOCUMENT NUMBER	DOC TYPE
				A3-SIZE	105431	1054311000-PK	GENERAL MARKET	1054311000-PK	PSD
								DOC PART	REVISION
								000	A
								SHEET NUMBER	
								2 OF 2	

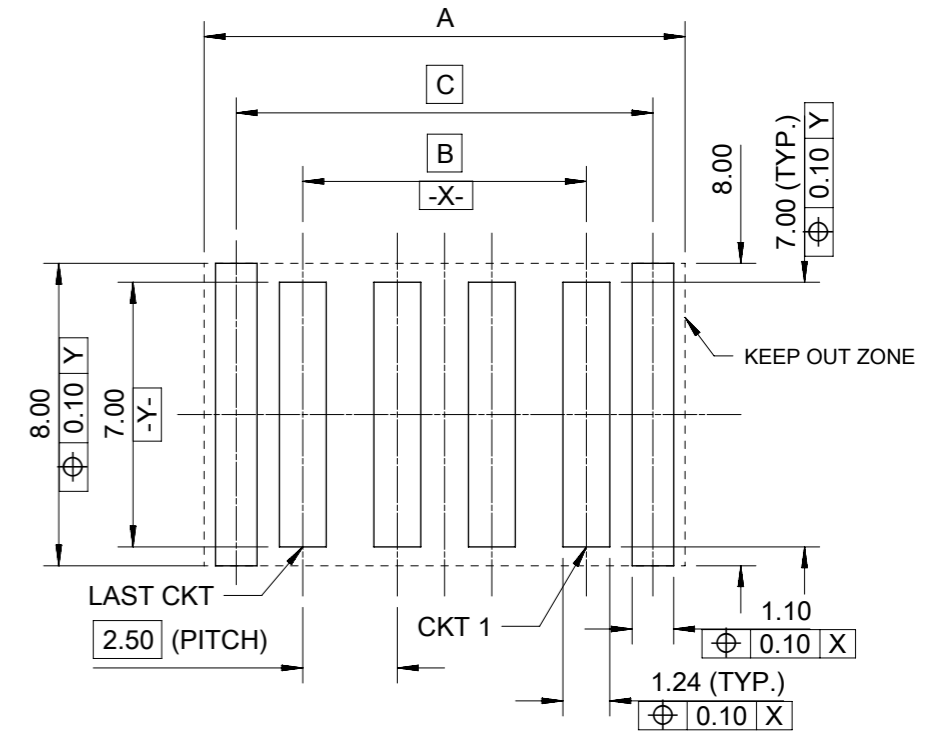
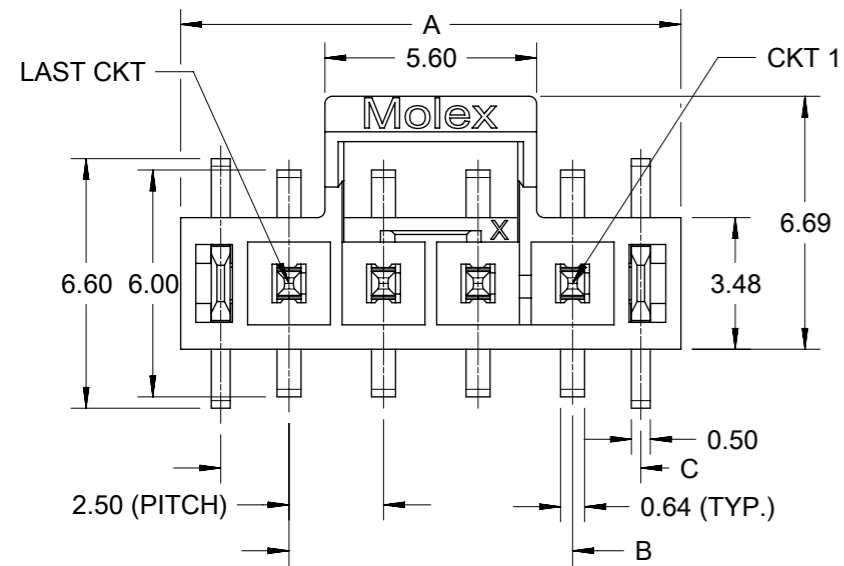

RECOMMENDED PCB LAYOUT(CONNECTOR SIDE VIEW)
THICKNESS=1.60mm MIN. TOLERANCE:±0.05



WITHOUT MYLAR



WITH MYLAR

THIS DRAWING CONTAINS INFORMATION THAT IS PROPRIETARY TO MOLEX ELECTRONIC TECHNOLOGIES, LLC AND SHOULD NOT BE USED WITHOUT WRITTEN PERMISSION											
QUALITY SYMBOLS		EC NO: 670810 DRWN: GLLI CHK'D: YXZHENG APPR: YXZHENG			GENERAL TOLERANCES (UNLESS SPECIFIED) ANGULAR TOL ± 3.0 ° 4 PLACES ± 3 PLACES ± 2 PLACES ± 0.2 1 PLACE ± 0.3 0 PLACES ±		DIMENSION UNITS: mm SCALE: 5:1 DRWN BY: WJHUO DATE: 2014/10/30 CHK'D BY: DATE: APPR BY: AYIN DATE: 2015/03/12				
		DRAFT WHERE APPLICABLE MUST REMAIN WITHIN DIMENSIONS			DRAUGHTING SYMBOLS: A = 0 E = 0 F = 0 G = 0 H = 0 I = 0 J = 0 K = 0 L = 0 M = 0 N = 0 O = 0 P = 0 Q = 0 R = 0 S = 0 T = 0 U = 0 V = 0 W = 0 X = 0 Y = 0 Z = 0		DRAWING SIZE: A3 THIRD ANGLE PROJECTION		SD DRAWING FOR NANO-FIT HEADER OF SMT VERTICAL SINGLE CONN.		
RELEASE STATUS: P1		RELEASE DATE: 2021/07/22		09:31:37		PRODUCT CUSTOMER DRAWING		SERIES: 105431 MATERIAL NUMBER: SEE TABLE CUSTOMER: GENERAL MARKET		DOCUMENT NUMBER: SD-105431-001 DOC TYPE: PSD DOC PART: 000 SHEET NUMBER: 1 OF 4	

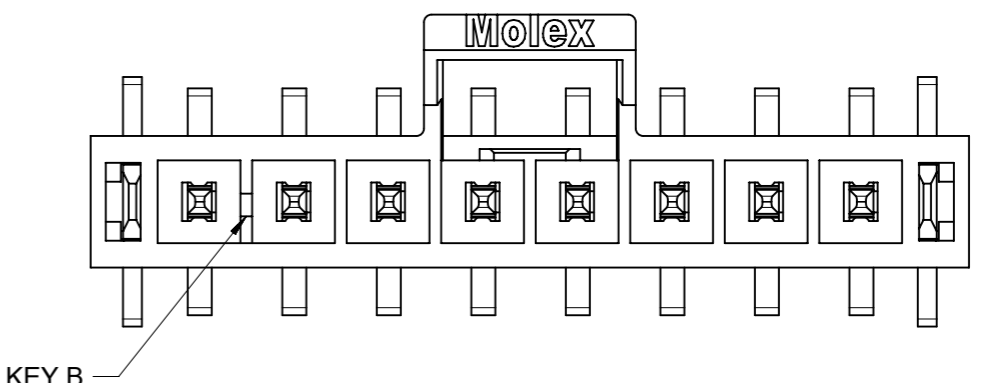
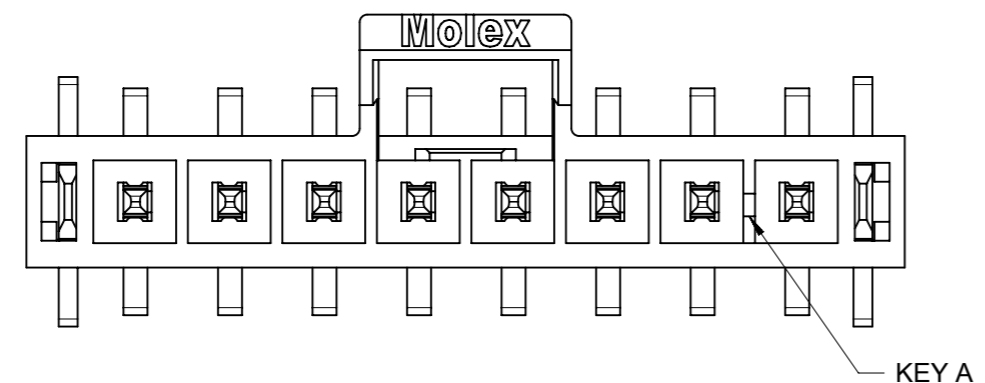
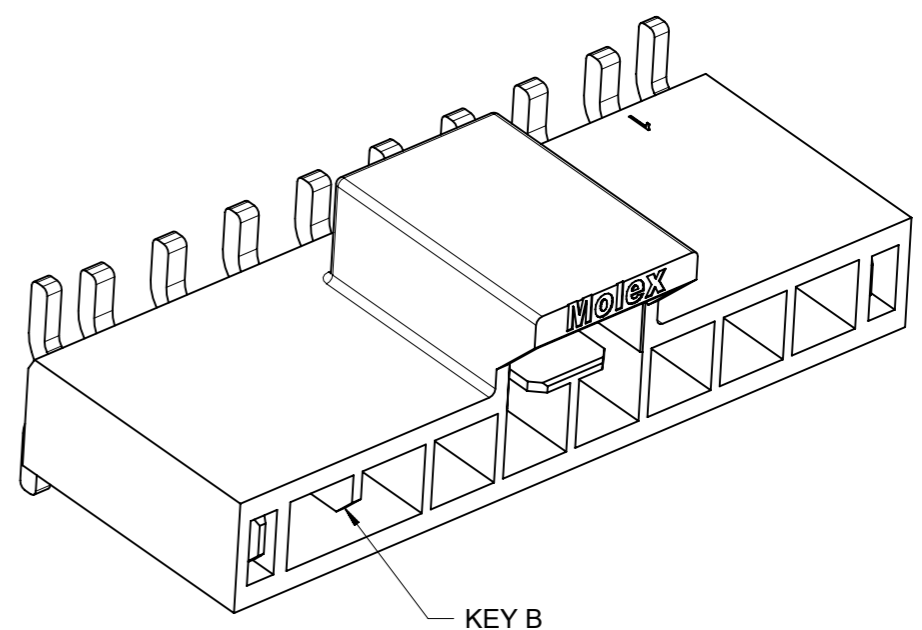
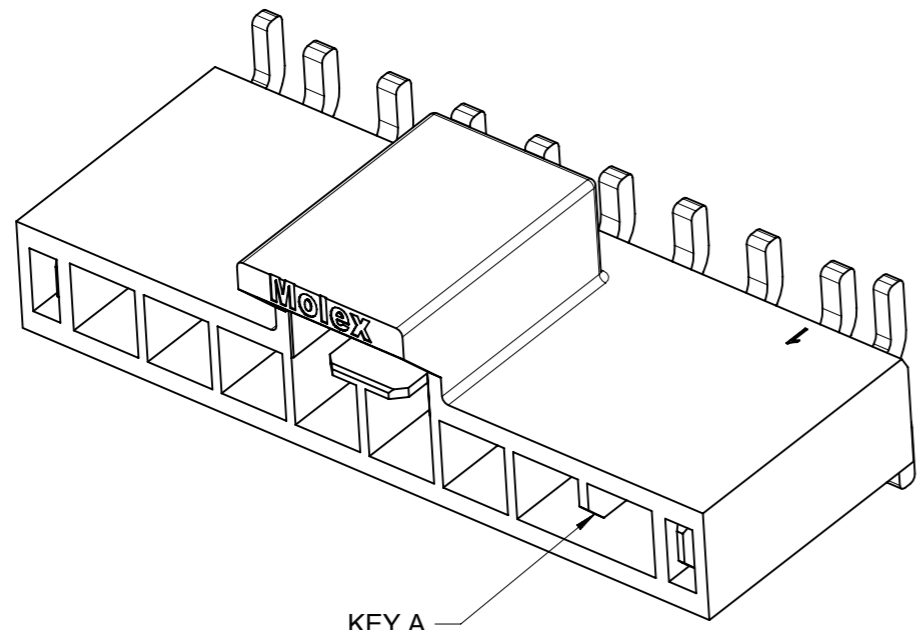

BLACK

NATURAL

COLOR OPTION

THIS DRAWING CONTAINS INFORMATION THAT IS PROPRIETARY TO MOLEX ELECTRONIC TECHNOLOGIES, LLC AND SHOULD NOT BE USED WITHOUT WRITTEN PERMISSION											
SYMBOLS	DIMENSION UNITS	SCALE	CURRENT REV DESC:								
	$\nabla = 0$	mm	EC NO: 670810								
$\nabla = 0$	GENERAL TOLERANCES (UNLESS SPECIFIED)		DRWN: GLLI 2021/04/27				SD DRAWING FOR NANO-FIT HEADER OF SMT VERTICAL SINGLE CONN.				
$\nabla = 0$	ANGULAR TOL $\pm 3.0^\circ$		CHK'D: YXZHENG 2021/07/22								
$\nabla = 0$	4 PLACES \pm		APPR: YXZHENG 2021/07/22				PRODUCT CUSTOMER DRAWING				
$\nabla = 0$	3 PLACES \pm		INITIAL REVISION:								
$\nabla = 0$	2 PLACES ± 0.2		DRWN: RMV02 2016/01/14				DOCUMENT NUMBER		DOC TYPE	DOC PART	REVISION
$\nabla = 0$	1 PLACE ± 0.3		APPR: AYIN 2017/05/15				SD-105431-001		PSD	000	D1
$\nabla = 0$	0 PLACES \pm		DRAFT WHERE APPLICABLE MUST REMAIN WITHIN DIMENSIONS		THIRD ANGLE PROJECTION	DRAWING	SERIES	MATERIAL NUMBER	CUSTOMER	SHEET NUMBER	
$\nabla = 0$						A3-SIZE	105431		GENERAL MARKET	2 OF 4	

9		8			7		6		5		4		3			2		1	
PART NUMBER (WITH MYLAR)	PART NUMBER (WITHOUT MYLAR)	DIM. A	DIM. B	DIM. C	CKT SIZE	PLATING	LUBE					PART NUMBER (WITH MYLAR)	PART NUMBER (WITHOUT MYLAR)	DIM. A	DIM. B	DIM. C	CKT SIZE	PLATING	LUBE
105431-1102	105431-1502	8.23	2.50	6.11	2	TIN						105431-2102	105431-2502	8.23	2.50	6.11	2	TIN	
105431-1103	105431-1503	10.73	5.00	8.61	3							105431-2103	105431-2503	10.73	5.00	8.61	3		
105431-1104	105431-1504	13.23	7.50	11.11	4							105431-2104	105431-2504	13.23	7.50	11.11	4		
105431-1105	105431-1505	15.73	10.00	13.61	5							105431-2105	105431-2505	15.73	10.00	13.61	5		
105431-1106	105431-1506	18.23	12.50	16.11	6							105431-2106	105431-2506	18.23	12.50	16.11	6		
105431-1107	105431-1507	20.73	15.00	18.61	7							105431-2107	105431-2507	20.73	15.00	18.61	7		
105431-1108	105431-1508	23.23	17.50	21.11	8							105431-2108	105431-2508	23.23	17.50	21.11	8		
105431-1202	105431-1602	8.23	2.50	6.11	2			GOLD 0.38	NO					105431-2202	105431-2602	8.23	2.50		
105431-1203	105431-1603	10.73	5.00	8.61	3							105431-2203	105431-2603	10.73	5.00	8.61	3		
105431-1204	105431-1604	13.23	7.50	11.11	4							105431-2204	105431-2604	13.23	7.50	11.11	4		
105431-1205	105431-1605	15.73	10.00	13.61	5							105431-2205	105431-2605	15.73	10.00	13.61	5		
105431-1206	105431-1606	18.23	12.50	16.11	6							105431-2206	105431-2606	18.23	12.50	16.11	6		
105431-1207	105431-1607	20.73	15.00	18.61	7							105431-2207	105431-2607	20.73	15.00	18.61	7		
105431-1208	105431-1608	23.23	17.50	21.11	8							105431-2208	105431-2608	23.23	17.50	21.11	8		
105431-1302	105431-1702	8.23	2.50	6.11	2	GOLD 0.76								105431-2302	105431-2702	8.23	2.50	6.11	2
105431-1303	105431-1703	10.73	5.00	8.61	3							105431-2303	105431-2703	10.73	5.00	8.61	3		
105431-1304	105431-1704	13.23	7.50	11.11	4							105431-2304	105431-2704	13.23	7.50	11.11	4		
105431-1305	105431-1705	15.73	10.00	13.61	5							105431-2305	105431-2705	15.73	10.00	13.61	5		
105431-1306	105431-1706	18.23	12.50	16.11	6							105431-2306	105431-2706	18.23	12.50	16.11	6		
105431-1307	105431-1707	20.73	15.00	18.61	7							105431-2307	105431-2707	20.73	15.00	18.61	7		
105431-1308	105431-1708	23.23	17.50	21.11	8							105431-2308	105431-2708	23.23	17.50	21.11	8		
105431-1402	105431-1802	8.23	2.50	6.11	2			GOLD 0.76	YES					105431-2402	105431-2802	8.23	2.50	6.11	2
105431-1403	105431-1803	10.73	5.00	8.61	3							105431-2403	105431-2803	10.73	5.00	8.61	3		
105431-1404	105431-1804	13.23	7.50	11.11	4							105431-2404	105431-2804	13.23	7.50	11.11	4		
105431-1405	105431-1805	15.73	10.00	13.61	5							105431-2405	105431-2805	15.73	10.00	13.61	5		
105431-1406	105431-1806	18.23	12.50	16.11	6							105431-2406	105431-2806	18.23	12.50	16.11	6		
105431-1407	105431-1807	20.73	15.00	18.61	7							105431-2407	105431-2807	20.73	15.00	18.61	7		
105431-1408	105431-1808	23.23	17.50	21.11	8							105431-2408	105431-2808	23.23	17.50	21.11	8		
		COLOR: BLACK										COLOR: NATURAL							

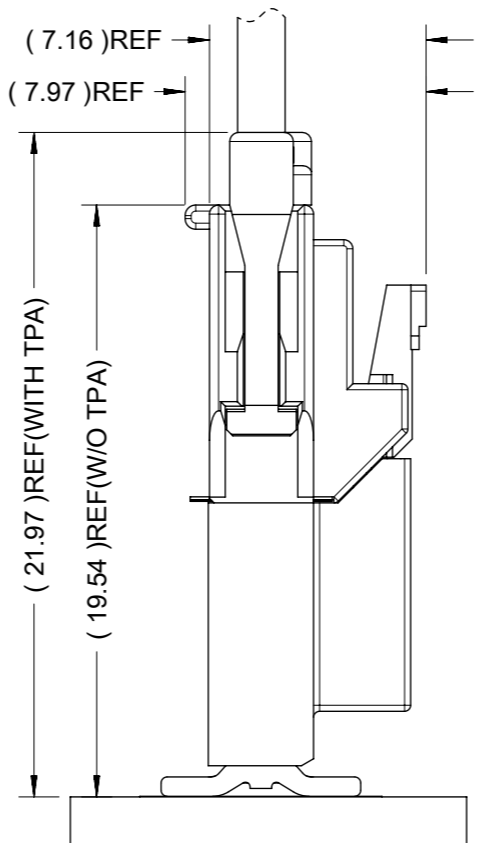

NOTES FOR ALL PARTS







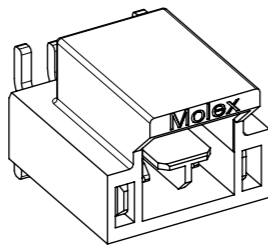
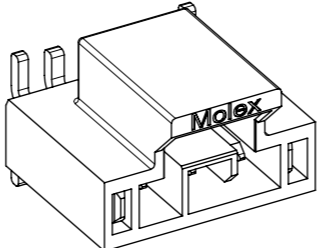
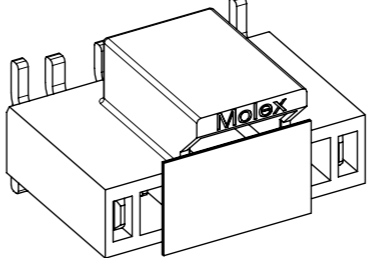
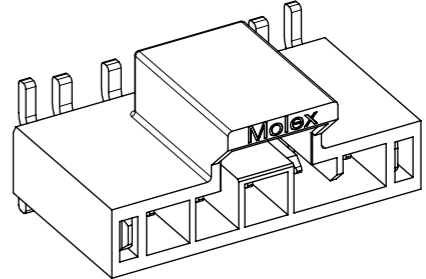
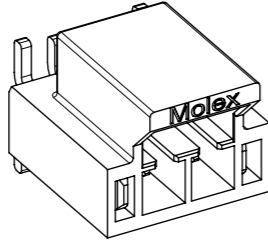
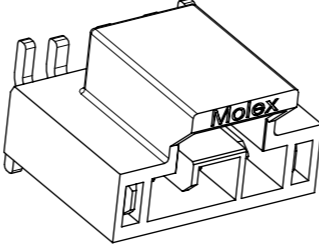
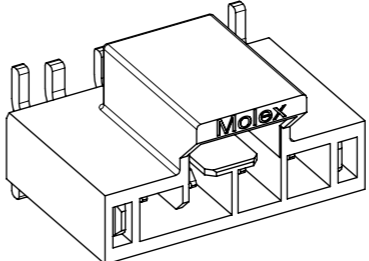
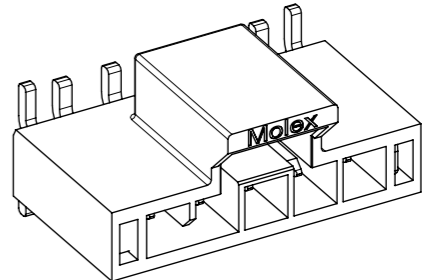
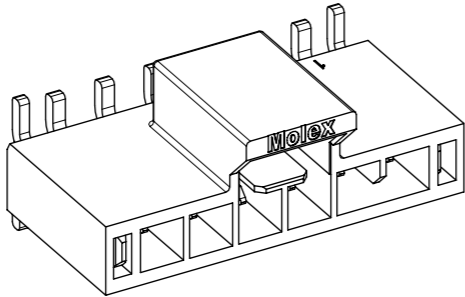
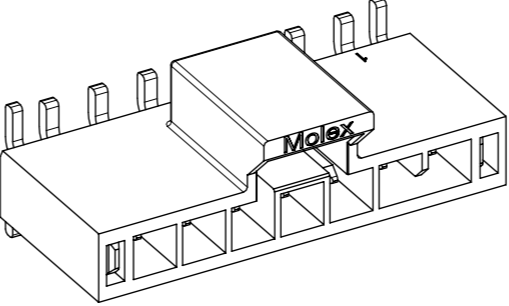
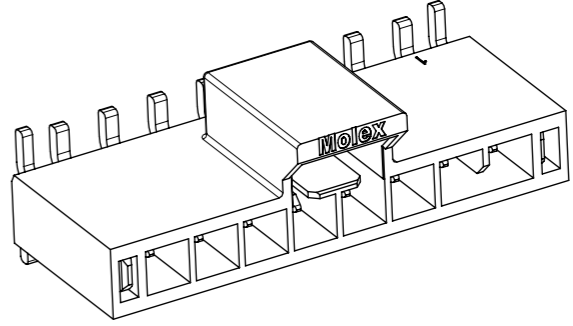
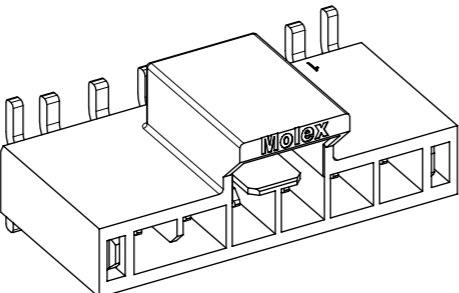
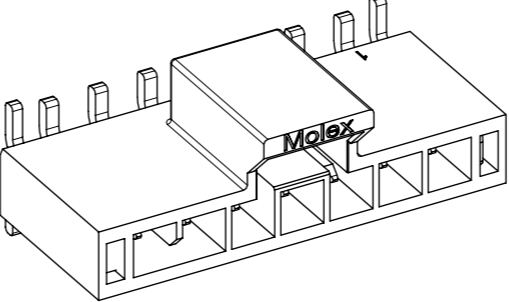
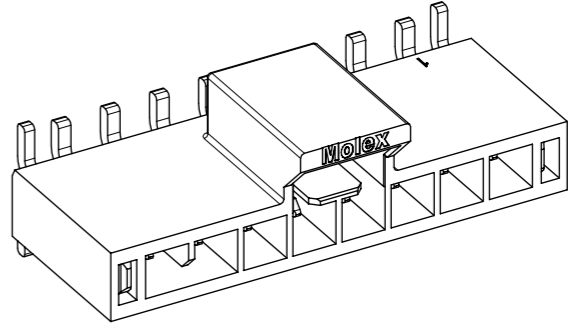

1> MATERIAL:
HOUSING: LCP, UL 94V-0.
TERMINAL: BRASS.
SOLDER CLIP: BRASS.

2> PLATING FINISHED:
TERMINAL:
CONTACT AREA:
a. REFLOWED MATTE TIN 0.76 MICRONS MIN; b. GOLD 0.38 MICRONS MIN; c. GOLD 0.76 MICRONS MIN.
SOLDER AREA: TIN 0.76 MICRONS MINIMUM.
UNDER PLATING NICKEL 1.25 MICRONS MINIMUM.
SOLDER CLIP: TIN 2.5 MICRONS MINIMUM; UNDER PLATING NICKEL 1.25 MICRONS MINIMUM.

3> PRODUCT SPECIFICATION: PS-105405-001.
4> PACKAGE: TAPE REEL, DETAILS REFER TO DRAWING 1054311000-PK.
5> ALL COMPONENTS AND PRODUCT COMPLIANT TO RoHS DIRECTIVE 2011/65/EU AND ELV DIRECTIVE 2000/53/EC.
6> PRODUCT MATE WITH SERIES OF 105307(RECEPTACLE), 105300(CRIMP TERMINAL).
7> PARTS CONFORM TO CLASS 'B' REQUIREMENTS OF COSMETIC SPECIFICATION PS-45499-002.

<table border="1"> <tr><th>QUALITY SYMBOLS</th><th>THIS DRAWING CONTAINS INFORMATION THAT IS PROPRIETARY TO MOLEX ELECTRONIC TECHNOLOGIES, LLC AND SHOULD NOT BE USED WITHOUT WRITTEN PERMISSION</th></tr> <tr><td>▽A = 0</td><td rowspan="10"> EC NO: 670810 DRWN: GLLI CHK'D: YXZHENG APPR: YXZHENG DATE: 2021/07/22 2021/07/22 2021/07/22 </td></tr> <tr><td>▽E = 0</td></tr> <tr><td>▽B = 0</td></tr> <tr><td>▽ = 0</td></tr> <tr><td>▽C = 0</td></tr> <tr><td>▽ = 0</td></tr> <tr><td>▽ = 0</td></tr> <tr><td>▽ = 0</td></tr> <tr><td>▽ = 0</td></tr> <tr><td>▽ = 0</td></tr> </table>										QUALITY SYMBOLS	THIS DRAWING CONTAINS INFORMATION THAT IS PROPRIETARY TO MOLEX ELECTRONIC TECHNOLOGIES, LLC AND SHOULD NOT BE USED WITHOUT WRITTEN PERMISSION	▽A = 0	EC NO: 670810 DRWN: GLLI CHK'D: YXZHENG APPR: YXZHENG DATE: 2021/07/22 2021/07/22 2021/07/22	▽E = 0	▽B = 0	▽ = 0	▽C = 0	▽ = 0	▽ = 0	▽ = 0	▽ = 0	▽ = 0	<table border="1"> <tr><th>GENERAL TOLERANCES (UNLESS SPECIFIED)</th><th>DIMENSION UNITS</th><th>SCALE</th></tr> <tr><td>ANGULAR TOL ± 3.0 °</td><td>mm</td><td>5:1</td></tr> <tr><td>4 PLACES ±</td><td>DRWN BY</td><td>DATE</td></tr> <tr><td>3 PLACES ±</td><td>WJHUO</td><td>2014/10/30</td></tr> <tr><td>2 PLACES ± 0.2</td><td>CHK'D BY</td><td>DATE</td></tr> <tr><td>1 PLACE ± 0.3</td><td>APPR BY</td><td>DATE</td></tr> <tr><td>0 PLACES ±</td><td>AYIN</td><td>2015/03/12</td></tr> <tr><td>DRAFT WHERE APPLICABLE MUST REMAIN WITHIN DIMENSIONS</td><td>DRAWING SIZE</td><td>THIRD ANGLE PROJECTION</td></tr> <tr><td></td><td>A3</td><td></td></tr> </table>		GENERAL TOLERANCES (UNLESS SPECIFIED)	DIMENSION UNITS	SCALE	ANGULAR TOL ± 3.0 °	mm	5:1	4 PLACES ±	DRWN BY	DATE	3 PLACES ±	WJHUO	2014/10/30	2 PLACES ± 0.2	CHK'D BY	DATE	1 PLACE ± 0.3	APPR BY	DATE	0 PLACES ±	AYIN	2015/03/12	DRAFT WHERE APPLICABLE MUST REMAIN WITHIN DIMENSIONS	DRAWING SIZE	THIRD ANGLE PROJECTION		A3		<table border="1"> <tr><th colspan="3">molex</th></tr> <tr><td colspan="3">SD DRAWING FOR NANO-FIT HEADER OF SMT VERTICAL SINGLE CONN.</td></tr> <tr><td colspan="3">PRODUCT CUSTOMER DRAWING</td></tr> <tr><td>SERIES</td><td>MATERIAL NUMBER</td><td>CUSTOMER</td></tr> <tr><td>105431</td><td>SEE TABLE</td><td>GENERAL MARKET</td></tr> <tr><td>DOCUMENT NUMBER</td><td>DOC TYPE</td><td>DOC PART</td><td>SHEET NUMBER</td></tr> <tr><td>SD-105431-001</td><td>PSD</td><td>000</td><td>3 OF 4</td></tr> </table>			molex			SD DRAWING FOR NANO-FIT HEADER OF SMT VERTICAL SINGLE CONN.			PRODUCT CUSTOMER DRAWING			SERIES	MATERIAL NUMBER	CUSTOMER	105431	SEE TABLE	GENERAL MARKET	DOCUMENT NUMBER	DOC TYPE	DOC PART	SHEET NUMBER	SD-105431-001	PSD	000	3 OF 4
QUALITY SYMBOLS	THIS DRAWING CONTAINS INFORMATION THAT IS PROPRIETARY TO MOLEX ELECTRONIC TECHNOLOGIES, LLC AND SHOULD NOT BE USED WITHOUT WRITTEN PERMISSION																																																																												
▽A = 0	EC NO: 670810 DRWN: GLLI CHK'D: YXZHENG APPR: YXZHENG DATE: 2021/07/22 2021/07/22 2021/07/22																																																																												
▽E = 0																																																																													
▽B = 0																																																																													
▽ = 0																																																																													
▽C = 0																																																																													
▽ = 0																																																																													
▽ = 0																																																																													
▽ = 0																																																																													
▽ = 0																																																																													
▽ = 0																																																																													
GENERAL TOLERANCES (UNLESS SPECIFIED)	DIMENSION UNITS	SCALE																																																																											
ANGULAR TOL ± 3.0 °	mm	5:1																																																																											
4 PLACES ±	DRWN BY	DATE																																																																											
3 PLACES ±	WJHUO	2014/10/30																																																																											
2 PLACES ± 0.2	CHK'D BY	DATE																																																																											
1 PLACE ± 0.3	APPR BY	DATE																																																																											
0 PLACES ±	AYIN	2015/03/12																																																																											
DRAFT WHERE APPLICABLE MUST REMAIN WITHIN DIMENSIONS	DRAWING SIZE	THIRD ANGLE PROJECTION																																																																											
	A3																																																																												
molex																																																																													
SD DRAWING FOR NANO-FIT HEADER OF SMT VERTICAL SINGLE CONN.																																																																													
PRODUCT CUSTOMER DRAWING																																																																													
SERIES	MATERIAL NUMBER	CUSTOMER																																																																											
105431	SEE TABLE	GENERAL MARKET																																																																											
DOCUMENT NUMBER	DOC TYPE	DOC PART	SHEET NUMBER																																																																										
SD-105431-001	PSD	000	3 OF 4																																																																										
RELEASE STATUS	P1	RELEASE DATE	2021/07/22	09:31:37																																																																									

	2 CKT	3 CKT	4 CKT	5 CKT
BLACK				
NATURAL				
	6 CKT	7 CKT	8 CKT	
BLACK				
NATURAL				

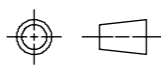
THIS DRAWING CONTAINS INFORMATION THAT IS PROPRIETARY TO MOLEX ELECTRONIC TECHNOLOGIES, LLC AND SHOULD NOT BE USED WITHOUT WRITTEN PERMISSION													
QUALITY SYMBOLS  = 0  = 0  = 0  = 0  = 0  = 0  = 0  = 0		EC NO: 670810 DRWN: GLLI CHK'D: YXZHENG APPR: YXZHENG		2021/04/27 2021/07/22 2021/07/22		GENERAL TOLERANCES (UNLESS SPECIFIED) ANGULAR TOL ± 3.0 ° 4 PLACES ± 3 PLACES ± 2 PLACES ± 0.2 1 PLACE ± 0.3 0 PLACES ±		DRAFT WHERE APPLICABLE MUST REMAIN WITHIN DIMENSIONS		DIMENSION UNITS: mm SCALE: 3:1 DRWN BY: RMV02 DATE: 2016/01/14 CHK'D BY: DATE: APPR BY: AYIN DATE: 2017/05/15		 SD DRAWING FOR NANO-FIT HEADER OF SMT VERTICAL SINGLE CONN.	
PRODUCT CUSTOMER DRAWING		SERIES: 105431	MATERIAL NUMBER:		CUSTOMER: GENERAL MARKET		DRAWING SIZE: A3 THIRD ANGLE PROJECTION: 		DOCUMENT NUMBER: SD-105431-001		DOC TYPE: PSD	DOC PART: 000	SHEET NUMBER: 4 OF 4