

TINA2-M

~30° medium beam. Assembly with holder, installation tape and location pins.

SPECIFICATION:

| | |
|----------------|-----------|
| Dimensions | Ø 16.0 mm |
| Height | 9.5 mm |
| Fastening | tape, pin |
| ROHS compliant | yes ⓘ |



MATERIALS:

| Component | Type | Material | Colour | Finish |
|---------------|-------------|--------------|--------|--------|
| TINA2-XP-M | Single lens | PMMA | clear | |
| TINA2-HLD-BLK | Holder | PC | black | |
| TINA-TAPE3 | Tape | Acrylic foam | black | |

ORDERING INFORMATION:

| Component | | Qty in box | MOQ | MPQ | Box weight (kg) |
|--------------------------------|-------------|------------|-----|-----|-----------------|
| CA12377_TINA2-M | Single lens | 4140 | 230 | 230 | 8.3 |
| » Box size: 451 x 241 x 298 mm | | | | | |

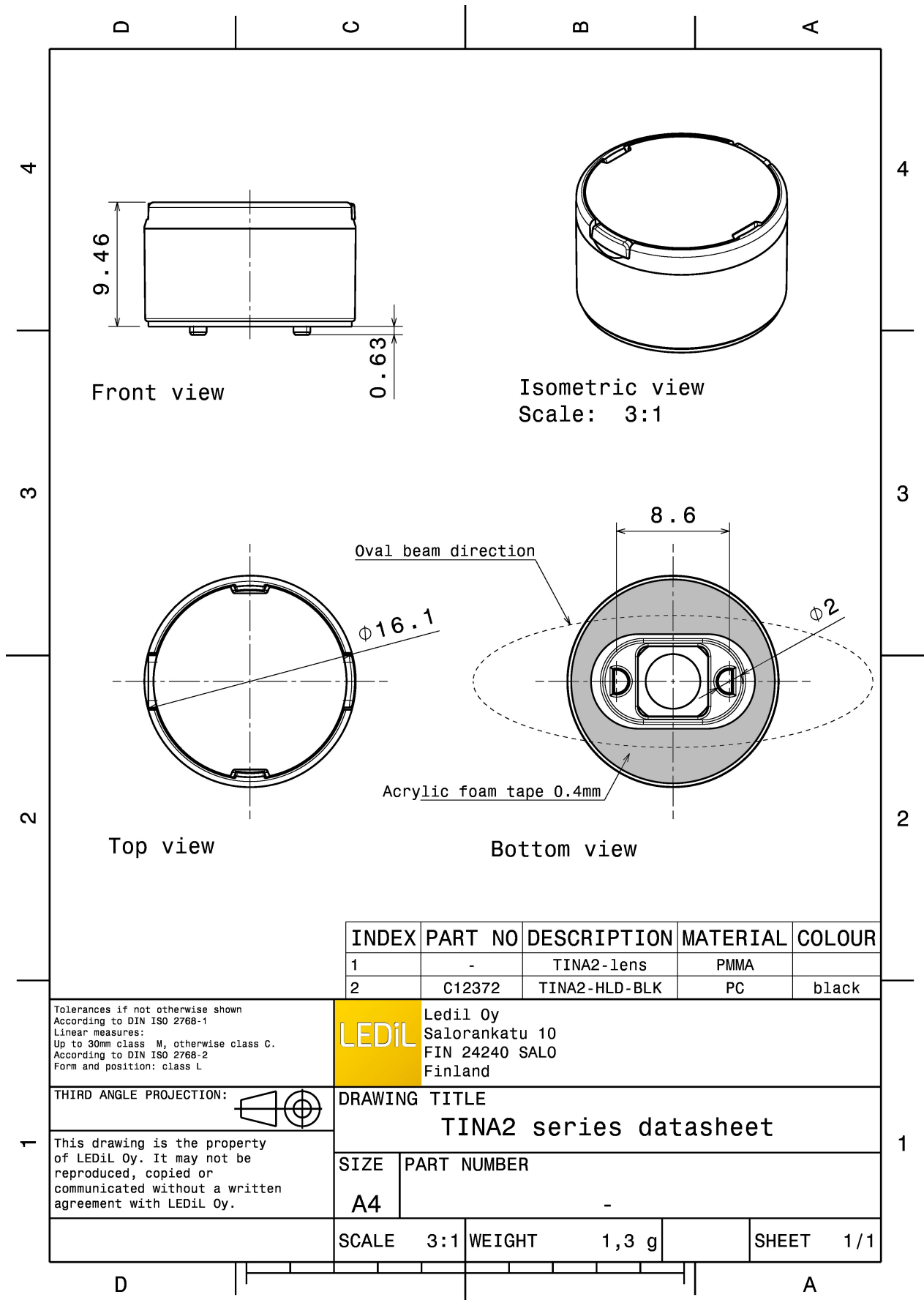

See also our general installation guide: www.ledil.com/installation_guide

OPTICAL RESULTS (MEASURED):

CREE LED

LED XB-H
FWHM / FWTM 31.0° / 54.0°
Efficiency 85 %
Peak intensity 2.7 cd/m
LEDs/each optic 1
Light colour White
Required components:

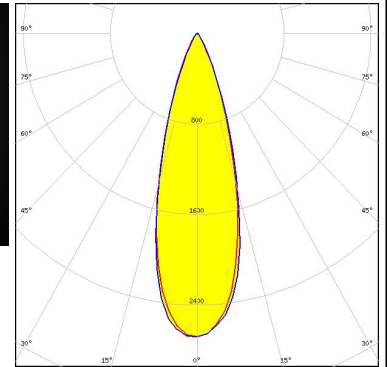
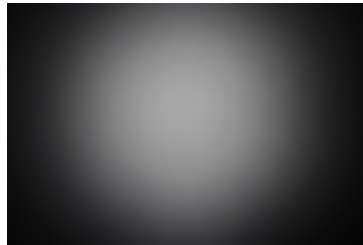

CREE LED

LED XD16
FWHM / FWTM 30.0° / 52.0°
Efficiency 83 %
Peak intensity 2.8 cd/m
LEDs/each optic 1
Light colour White
Required components:

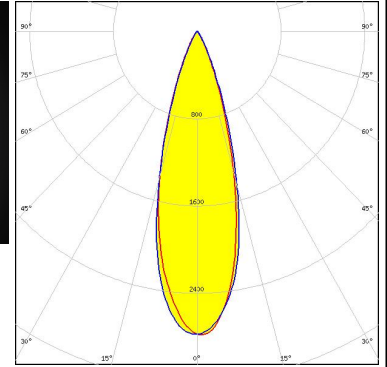

CREE LED

LED XQ-E HD
FWHM / FWTM 29.0° / 51.0°
Efficiency 84 %
Peak intensity 3.2 cd/m
LEDs/each optic 1
Light colour White
Required components:

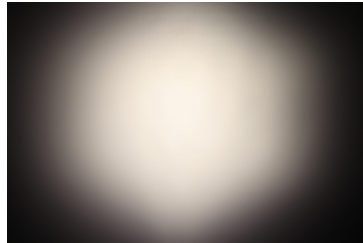

LUMILEDS

LED LUXEON CZ
FWHM / FWTM 28.0° / 47.0°
Efficiency 89 %
Peak intensity 3.4 cd/m
LEDs/each optic 1
Light colour White
Required components:

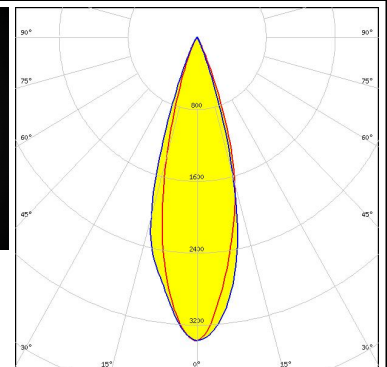
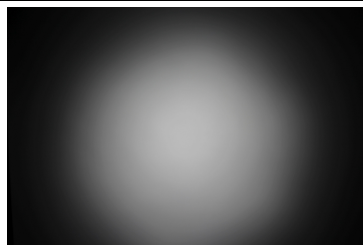

OPTICAL RESULTS (MEASURED):

LUMILEDS

LED LUXEON TX
 FWHM / FWTM 30.0° / 53.0°
 Efficiency 86 %
 Peak intensity 2.8 cd/m
 LEDs/each optic 1
 Light colour White
 Required components:

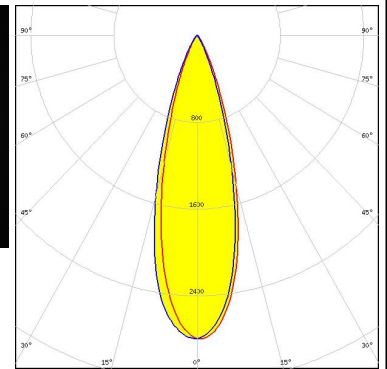
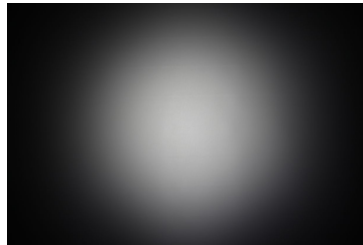

LUMILEDS

LED LUXEON Z ES
 FWHM / FWTM 31.0° / 50.0°
 Efficiency 88 %
 Peak intensity 3.2 cd/m
 LEDs/each optic 1
 Light colour White
 Required components:

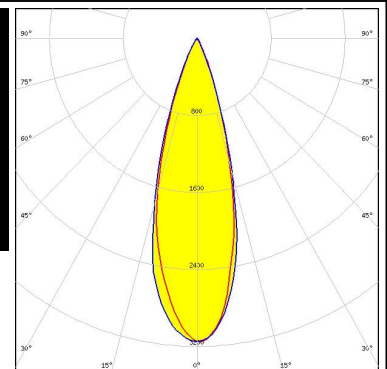
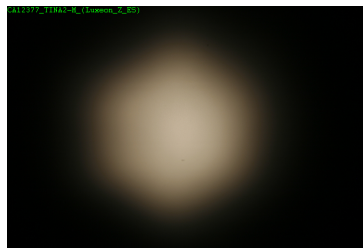

NICHIA

LED NVSxx19B/NVSxx19C
 FWHM / FWTM 29.0° / 55.0°
 Efficiency 85 %
 Peak intensity 2.7 cd/m
 LEDs/each optic 1
 Light colour White
 Required components:



NICHIA

LED NWSx229A
 FWHM / FWTM 26.0° / 52.0°
 Efficiency 86 %
 Peak intensity 2.2 cd/m
 LEDs/each optic 1
 Light colour White
 Required components:

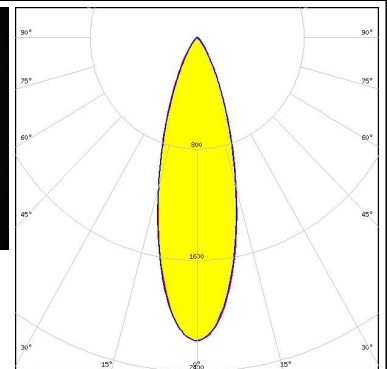
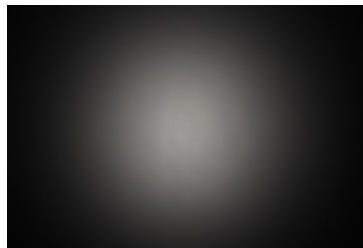

OPTICAL RESULTS (MEASURED):

OSRAM Opto Semiconductors

LED OSLON Square EC
 FWHM / FWTM 30.0° / 54.0°
 Efficiency 85 %
 Peak intensity 2.2 cd/lm
 LEDs/each optic 1
 Light colour White
 Required components:

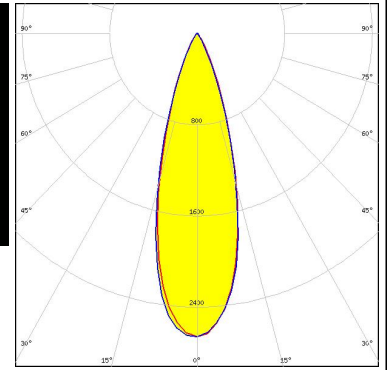

OSRAM Opto Semiconductors

LED OSLON Square PC
 FWHM / FWTM 29.0° / 53.0°
 Efficiency 86 %
 Peak intensity 2.4 cd/lm
 LEDs/each optic 1
 Light colour White
 Required components:

OSRAM Opto Semiconductors

LED SFH 4170S
 FWHM / FWTM 28.0° / 50.0°
 Efficiency %
 LEDs/each optic 1
 Light colour IR
 Required components:

OSRAM Opto Semiconductors

LED SFH 4180S
 FWHM / FWTM 29.0° / 49.0°
 Efficiency %
 LEDs/each optic 1
 Light colour IR
 Required components:

OPTICAL RESULTS (MEASURED):

OSRAM Opto Semiconductors

LED SFH 4715S
FWHM / FWTM 28.0° / 56.0°
Efficiency %
LEDs/each optic 1
Light colour IR
Required components:

OSRAM Opto Semiconductors

LED SFH 4725S
FWHM / FWTM 27.0° / 54.0°
Efficiency %
LEDs/each optic 1
Light colour IR
Required components:



SEOUL SEMICONDUCTOR

LED Z5M3
FWHM / FWTM 30.0° / 57.0°
Efficiency 83 %
Peak intensity 2.5 cd/lm
LEDs/each optic 1
Light colour White
Required components:

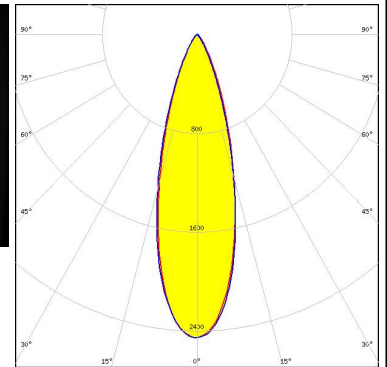
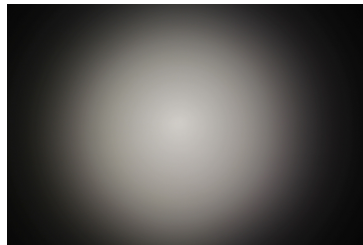

OPTICAL RESULTS (SIMULATED):



LED XB-D
 FWHM / FWTM 30.0° / 55.0°
 Efficiency 86 %
 Peak intensity 2.7 cd/lm
 LEDs/each optic 1
 Light colour White
 Required components:

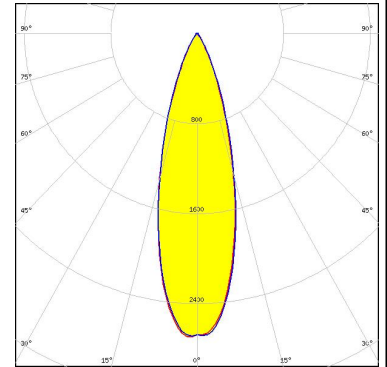

LED XQ-E HI
 FWHM / FWTM 29.0° / 51.0°
 Efficiency 90 %
 Peak intensity 3.2 cd/lm
 LEDs/each optic 1
 Light colour White
 Required components:

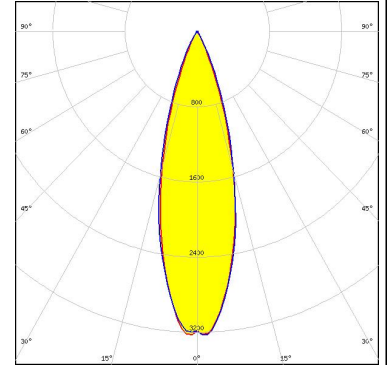

LED LUXEON 2835 Line
 FWHM / FWTM 30.0° / 55.0°
 Efficiency 96 %
 Peak intensity 2.9 cd/lm
 LEDs/each optic 1
 Light colour White
 Required components:

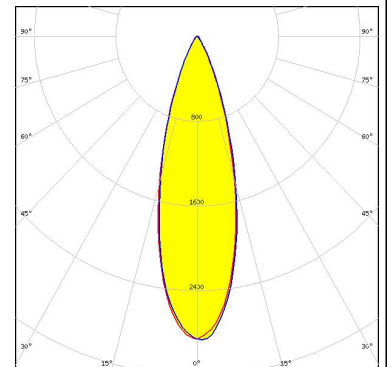

LED LUXEON C
 FWHM / FWTM 30.0° / 52.0°
 Efficiency 93 %
 Peak intensity 2.9 cd/lm
 LEDs/each optic 1
 Light colour White
 Required components:

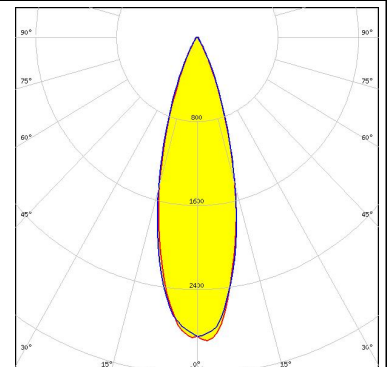

OPTICAL RESULTS (SIMULATED):

LUMILEDS

LED LUXEON IR Compact
 FWHM / FWTM 29.0° / 51.0°
 Efficiency 83 %
 LEDs/each optic 1
 Light colour IR
 Required components:

LUMILEDS

LED LUXEON Rubix
 FWHM / FWTM 28.0° / 53.0°
 Efficiency 91 %
 Peak intensity 3.1 cd/lm
 LEDs/each optic 1
 Light colour White
 Required components:

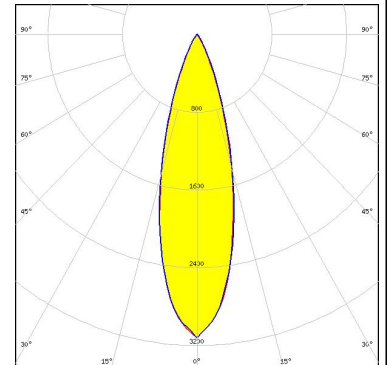

LUMILEDS

LED LUXEON Rubix
 FWHM / FWTM 29.0° / 52.0°
 Efficiency 91 %
 Peak intensity 3.1 cd/lm
 LEDs/each optic 1
 Light colour Red
 Required components:

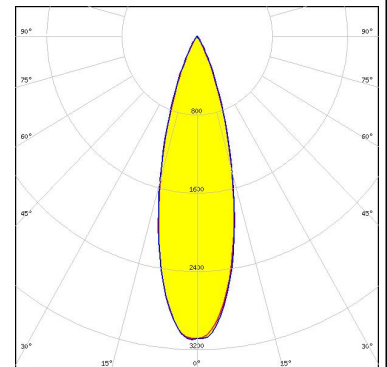

LUMILEDS

LED LUXEON Rubix
 FWHM / FWTM 30.0° / 53.0°
 Efficiency 91 %
 Peak intensity 3 cd/lm
 LEDs/each optic 1
 Light colour Blue
 Required components:

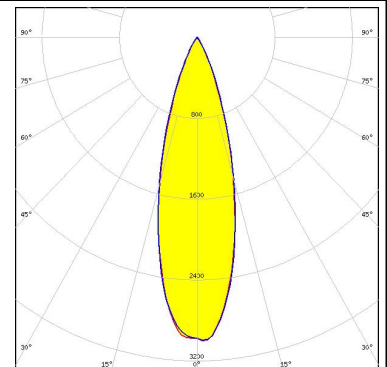

OPTICAL RESULTS (SIMULATED):

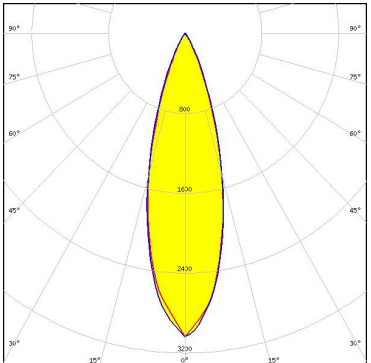
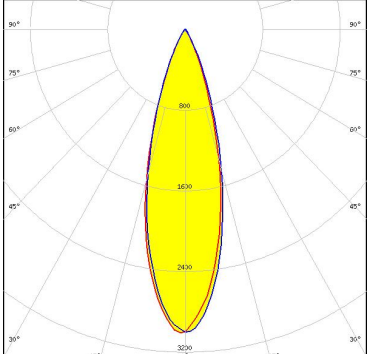
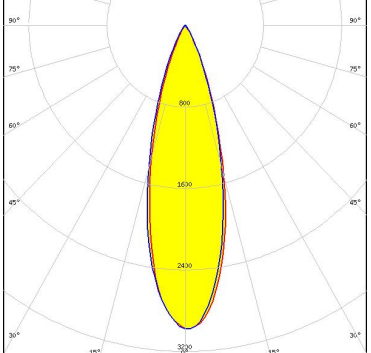
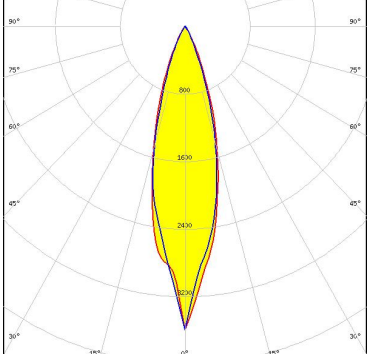
| | |
|--|---|
| <p>LUMILEDS</p> <p>LED LUXEON SunPlus 20 Line (150 deg) FWHM / FWTM 30.0° / 53.0° Efficiency 89 % Peak intensity 3 cd/lm LEDs/each optic 1 Light colour White Required components:</p> |  |
| <p>NICHIA</p> <p>LED NFSx757G FWHM / FWTM 29.0° / 53.0° Efficiency 90 % Peak intensity 3 cd/lm LEDs/each optic 1 Light colour White Required components:</p> |  |
| <p>OSRAM Opto Semiconductors</p> <p>LED Duris S5 (2 chip) FWHM / FWTM 29.0° / 54.0° Efficiency 92 % Peak intensity 3 cd/lm LEDs/each optic 1 Light colour White Required components:</p> |  |
| <p>OSRAM Opto Semiconductors</p> <p>LED OSCONIQ P 3030 FWHM / FWTM 26.0° / 50.0 + 52.0° Efficiency 90 % Peak intensity 3.6 cd/lm LEDs/each optic 1 Light colour Blue Required components:</p> |  |

OPTICAL RESULTS (SIMULATED):

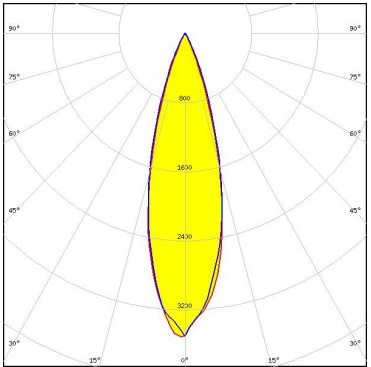
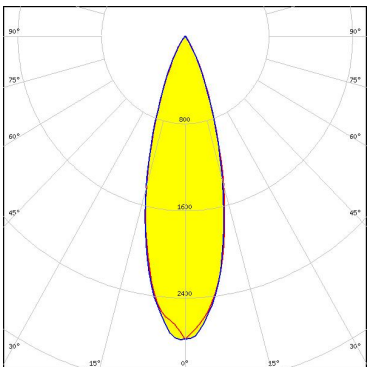
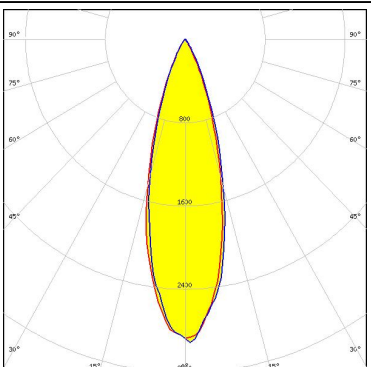
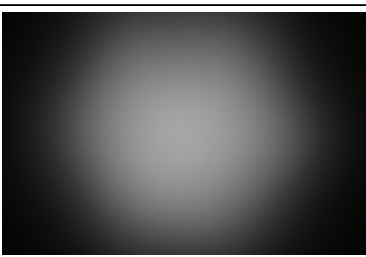
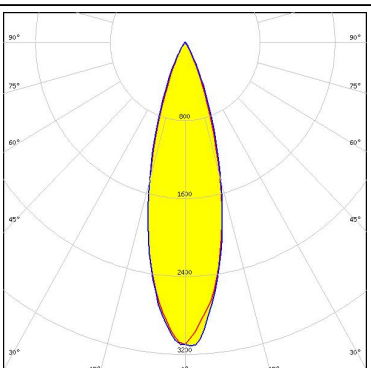
| | | | |
|--|--|---|---|
| OSRAM <small>Opto Semiconductors</small> | <p>LED OSLON Black Flat</p> <p>FWHM / FWTM 28.0° / 49.0°</p> <p>Efficiency 91 %</p> <p>Peak intensity 3.5 cd/lm</p> <p>LEDs/each optic 1</p> <p>Light colour White</p> <p>Required components:</p> |  | |
| OSRAM <small>Opto Semiconductors</small> | <p>LED OSLON Square CSSRM2/CSSRM3</p> <p>FWHM / FWTM 30.0° / 56.0°</p> <p>Efficiency 90 %</p> <p>Peak intensity 2.8 cd/lm</p> <p>LEDs/each optic 1</p> <p>Light colour White</p> <p>Required components:</p> |  | |
| OSRAM <small>Opto Semiconductors</small> | <p>LED OSLON Square CSSRM2/CSSRM3</p> <p>FWHM / FWTM 29.0° / 54.0°</p> <p>Efficiency 90 %</p> <p>Peak intensity 2.9 cd/lm</p> <p>LEDs/each optic 1</p> <p>Light colour White</p> <p>Required components:</p> |  | |
| OSRAM <small>Opto Semiconductors</small> | <p>LED OSLON Square Flat</p> <p>FWHM / FWTM 29.0° / 52.0°</p> <p>Efficiency 89 %</p> <p>Peak intensity 3.1 cd/lm</p> <p>LEDs/each optic 1</p> <p>Light colour White</p> <p>Required components:</p> |  |  |

OPTICAL RESULTS (SIMULATED):

OSRAM Opto Semiconductors

LED OSLO[®] SSL 150
FWHM / FW_{TM} 29.0° / 54.0°
Efficiency 90 %
Peak intensity 3 cd/lm
LEDs/each optic 1
Light colour White
Required components:

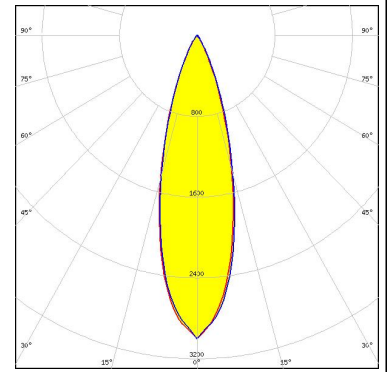

OSRAM Opto Semiconductors

LED OSLO[®] SSL 80
FWHM / FW_{TM} 29.0° / 53.0°
Efficiency 89 %
Peak intensity 3 cd/lm
LEDs/each optic 1
Light colour White
Required components:

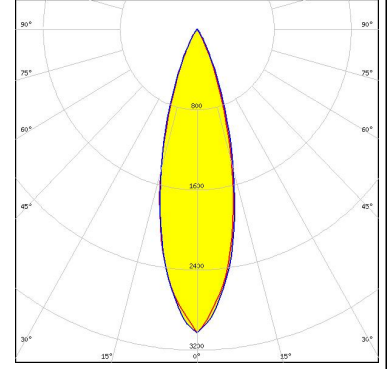

OSRAM Opto Semiconductors

LED SFH 4715S
FWHM / FW_{TM} 28.0° / 51.0°
Efficiency 90 %
LEDs/each optic 1
Light colour IR
Required components:

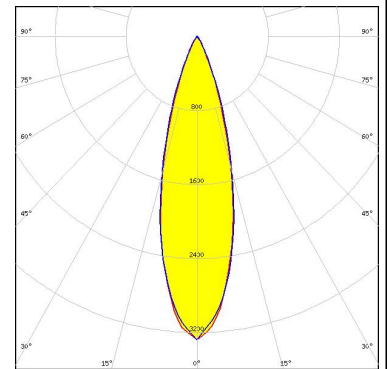

OSRAM Opto Semiconductors

LED SFH 4770S
FWHM / FW_{TM} 27.0° / 51.0°
Efficiency 85 %
LEDs/each optic 1
Light colour IR
Required components:

OPTICAL RESULTS (SIMULATED):

OSRAM

Opto Semiconductors

LED Synios P2720 1 mm
 FWHM / FWTM 27.0° / 50.0°
 Efficiency 91 %
 Peak intensity 3.6 cd/lm
 LEDs/each optic 1
 Light colour White
 Required components:

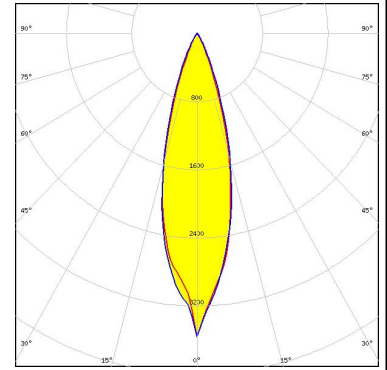

OSRAM

Opto Semiconductors

LED Synios P2720 1/2 mm
 FWHM / FWTM 29.0° / 51.0°
 Efficiency 93 %
 Peak intensity 3.4 cd/lm
 LEDs/each optic 1
 Light colour White
 Required components:

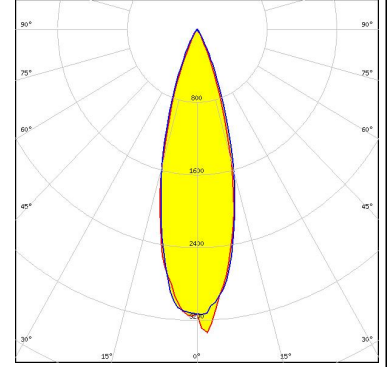

OSRAM

Opto Semiconductors

LED Synios P2720 1/4 mm
 FWHM / FWTM 28.0° / 50.0°
 Efficiency 91 %
 Peak intensity 3.1 cd/lm
 LEDs/each optic 1
 Light colour White
 Required components:

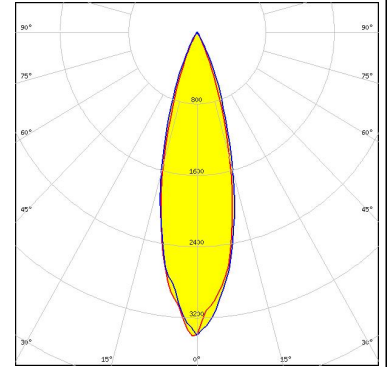

SAMSUNG

LED LH181B
 FWHM / FWTM 29.0° / 53.5°
 Efficiency 90 %
 Peak intensity 3 cd/lm
 LEDs/each optic 1
 Light colour White
 Required components:

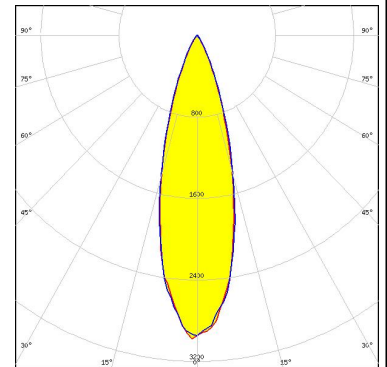

GENERAL INFORMATION:

NOTE: The typical beam angle will be changed by different color, chip size and chip position tolerance. The typical total beam angle is the full angle measured where the luminous intensity is half of the peak value.

MATERIALS:

As part of our continuous research and improvement processes, and to ensure the best possible quality and availability of our products, LEDiL reserves the right to change material grades without notice.

PRODUCT DATA USER AGREEMENT AND DISCLAIMER:

The measured data in the provided downloadable LEDiL Product Datasheets and Mechanical 2D-Drawings is rounded and provided as reference for planning. LEDiL Oy's optical specifications have been verified by conducting performance testing of the products in accordance with the company's quality system. The reported data are averaged results of multiple measurements with typical variation. LEDiL Oy reserves the right to without prior notification make changes and improvements to its products.

LEDiL Oy assumes neither warranty, nor guarantee nor any other liability of any kind for the contents and correctness of the provided data. The provided data has been generated with highest diligence but the provided data may in reality not represent the complete possible variation range of all intrinsic parameters. Therefore, in certain cases a deviation from the provided data could occur.

LEDiL Oy reserves the right to undertake technical changes of its products without further notification which could lead to changes in the provided data. LEDiL Oy assumes no liability of any kind for the possible deviation from any provided data or any other damage resulting from the usage of the provided data.

The user agrees to this disclaimer and user agreement with the download or usage of the provided files.

LEDiL Oy

Joensuunkatu 13
FI-24240 SALO
Finland

LEDiL Inc.

228 West Page Street
Suite D
Sycamore IL 60178
USA

Ledil Optics Technology (Shenzhen) Co., Ltd.

405 , Block B
Casic Motor Building
Shenzhen 518057
P.R.CHINA

Local sales and technical support

[www.ledil.com/
where_to_buy](http://www.ledil.com/where_to_buy)

Shipping locations

Salo, Finland
Hong Kong, China

Distribution Partners

[www.ledil.com/
where_to_buy](http://www.ledil.com/where_to_buy)