

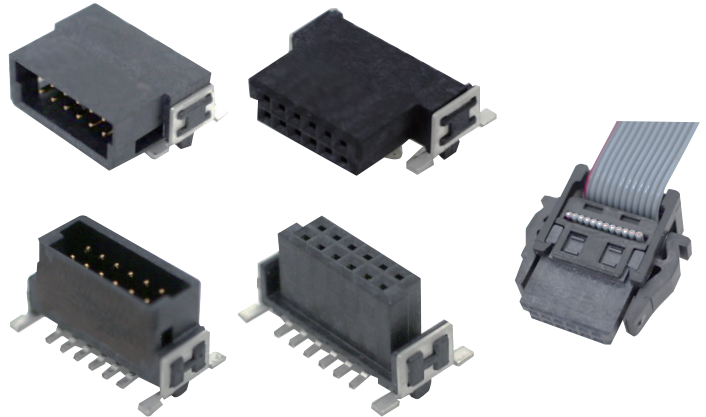

XH5-N

Half-Pitch SMT Connectors (Board to Board and Board to Cable Connectors)

SMT Connectors with 1.27-mm Pitch

- These SMT connectors allows other components to be mounted on the back of surfaces of circuit boards.
- Circuit board positioning bosses provide accurate mounting on circuit boards.
- Compatible with reflow mounting.
- Variety of contact numbers, board connection directions (vertical, horizontal, stacking) and variety of stacking heights allow flexible product design.
- Through-hole reflow hold-down types (THR type) are available for enhanced board mounting.
- Crimping sockets are available for easier on-site harness assembling. Also available with harness as standard.



 Refer to "Precautions" on page 13.

Terminology

● SMT

An abbreviation for Surface Mount Technology.

● Stacking connections

Stacking circuit boards and connecting them parallel to each other. The distance between the stacked circuit boards is called the stacking height.

● Vertical connection

Connecting circuit boards vertically.

● Horizontal connection



Connecting circuit boards horizontally.

● THR



An abbreviation for Through-Hole Reflow. Mounting technology combined with through-hole solder connection for higher mechanical stability and surface-mounting for automation process.

Connectors

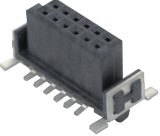

Board mounting type: Terminal part/hold-down part SMT type

Model	XH5A-□□15-N Plug, Right-angle	XH5E-□□15-□N Plug, Straight	XH5F-□□15-N Socket, Right-angle	XH5B-□□15-□N Socket, Straight
Appearance				
Page		P.3		P.6

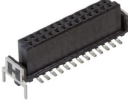
Board mounting type: Terminal part SMT type, hold-down part THR type

Model	XH5A-□□16-N Plug, Right-angle	XH5E-□□16-□N Plug, Straight	XH5B-□□16-□N Socket, Straight
Appearance			
Page		P.4	P.7

Cable connection type/Cable with connectors on both ends

Model	XH5M-□□10-N Socket, IDC Type	XH5T-□□04-N Strain Relief	XH5H-□□10-□□N Cable with Connectors on Both Ends (Socket/Socket)
Appearance			
Page		P.9	P.11

XH5-N

Part Number Structure

Board Mounting Type

XH5 - 1 - N
 (1) (2) (3) (4)

(1) Type

Code	Type
A	Plug, Right-angle
B	Socket, Straight
E	Plug, Straight
F	Socket, Right-angle

(2) Number of contacts

Code	Number of contacts
12	12 contacts
20	20 contacts
26	26 contacts
32	32 contacts
40	40 contacts
50	50 contacts
68	68 contacts
80	80 contacts

(3) Terminal

Code	Type
5	Terminal part/hold-down part SMT type
6	Terminal part SMT type, hold-down part THR type

(4) Height of Straight Plug/Socket

Code	Height
NO	- (Right-angle Plug/Socket)
1	6.6 mm
2	8.1 mm
3	9.7 mm
4	6.25 mm
5	9.05 mm
6	13.65 mm

Note: Symbols 1, 2 and 3 are limited to plugs, while symbols 4, 5 and 6 are limited to sockets.

Socket, IDC Type

XH5M- 10-N

(1) Number of contacts

Code	Number of contacts
12	12 contacts
20	20 contacts
26	26 contacts
32	32 contacts
40	40 contacts
50	50 contacts
68	68 contacts
80	80 contacts

Strain Relief

XH5T- 04-N

(1) Number of contacts

Code	Number of contacts
12	12 contacts
20	20 contacts
26	26 contacts
32	32 contacts
40	40 contacts
50	50 contacts
68	68 contacts
80	80 contacts

Cable with Connectors on Both Ends

XH5H- 10- N
 (1) (2)

(1) Number of contacts

Code	Number of contacts
12	12 contacts
20	20 contacts
26	26 contacts
32	32 contacts
40	40 contacts
50	50 contacts
68	68 contacts
80	80 contacts

(2) Cable Length

Code	Length
10	100 mm
20	200 mm
30	300 mm
50	500 mm
70	700 mm
1M	1000 mm

Ratings / Characteristics

Rated current	1 A
Rated voltage	100 VAC
Contact resistance	25 mΩ max. (at 20 m VDC, 100 mA max.)
Insulation resistance	1000 MΩ min. (at 100 VDC)
Dielectric strength	500 VAC for 1 min.
Insertion durability	500 times
Ambient operating temperature	-55 to +105°C (with no condensation or icing)*1

*1. The temperature of -20 to +105°C is limited to XH5H-N.

Materials and Finish

		Model	XH5A-N/XH5B-N/ XH5E-N/XH5F-N	XH5M-N	XH5T-N
Item	Housing		LCP (UL94 V-0)/black	LCP (UL94 V-0)/black	-
	Cover		-	PBT (UL94 V-0)/black	-
Contacts	Mating end		Copper alloy/gold plated	Copper alloy/gold plated	-
	Terminals IDC end		Copper alloy/tin plated	Copper alloy/tin plated	-
Hold-down			Copper alloy/tin plated	-	-
Strain Relief			-	-	PBT (UL94 V-0)/black

Applicable Wire

0.635 mm pitch flat cable AWG30 (7 twisted wires)

XH5A-N/XH5E-N

Plug, Terminal part/hold-down part SMT type

Dimensions

CAD Data Please visit our CAD Data website, which is noted on the last page.

(Unit: mm)

XH5A-□□15-N
Plug, Right-angle
Terminal part/hold-down part SMT type

CAD Data

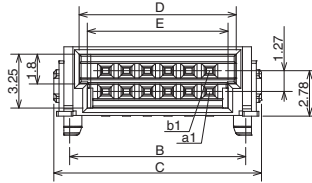
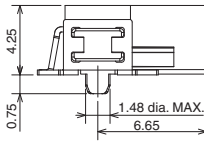
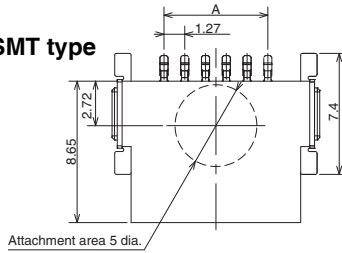

Mounting Holes

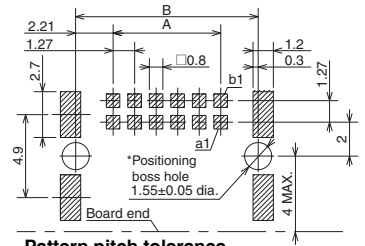

Pattern pitch tolerance

Note: The overall pattern pitch tolerance for the board is ±0.03. Do not accumulate error.
 * The 1.55±0.05 diameter holes are for the positioning bosses. Use metal masks to prevent solder from entering these holes.

Table of Dimensions

Model	Number of contacts	A	B	C	D	E
XH5A-1215-N	12	6.35	10.77	12.70	9.57	8.57
XH5A-2015-N	20	11.43	15.85	17.78	14.65	13.65
XH5A-2615-N	26	15.24	19.66	21.59	18.46	17.46
XH5A-3215-N	32	19.05	23.47	25.40	22.27	21.27
XH5A-4015-N	40	24.13	28.55	30.48	27.35	26.35
XH5A-5015-N	50	30.48	34.90	36.83	33.70	32.70
XH5A-6815-N	68	41.91	46.33	48.26	45.13	44.13
XH5A-8015-N	80	49.53	53.95	55.88	52.75	51.75

XH5E-□□15-□N
Plug, Straight
Terminal part/hold-down part SMT type

CAD Data

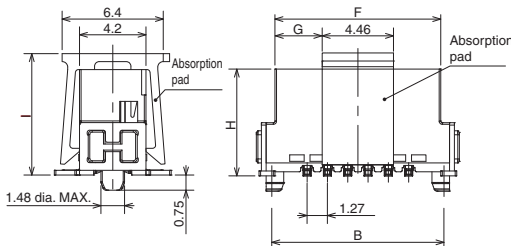
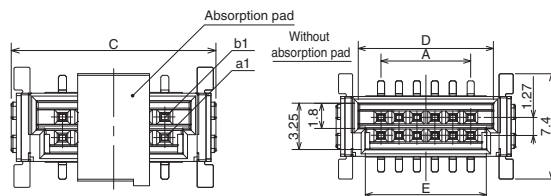

Mounting Holes

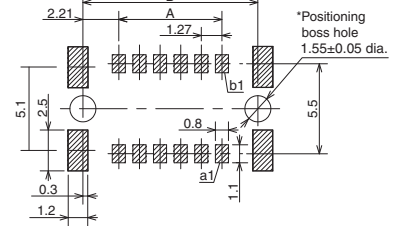

Pattern pitch tolerance

Note: The overall pattern pitch tolerance for the board is ±0.03. Do not accumulate error.
 * The 1.55±0.05 diameter holes are for the positioning bosses. Use metal masks to prevent solder from entering these holes.

Table of Dimensions

Model	Number of contacts	A	B	C	D	E	F	G	H	I
XH5E-1215-□N	12	6.35	10.77	12.70	9.57	8.57	10.37	2.96	1: 6.6 2: 8.1 3: 9.7	1: 7.6 2: 9.1 3: 10.7
XH5E-2015-□N	20	11.43	15.85	17.78	14.65	13.65	15.45	5.50		
XH5E-2615-□N	26	15.24	19.66	21.59	18.46	17.46	19.26	7.40		
XH5E-3215-□N	32	19.05	23.47	25.40	22.27	21.27	23.07	9.31		
XH5E-4015-□N	40	24.13	28.55	30.48	27.35	26.35	28.15	11.85		
XH5E-5015-□N	50	30.48	34.90	36.83	33.70	32.70	34.50	15.02		
XH5E-6815-□N	68	41.91	46.33	48.26	45.13	44.13	45.93	20.74		
XH5E-8015-□N	80	49.53	53.95	55.88	52.75	51.75	53.55	24.55		

Note: □ is replaced by 1 to 3 to indicate the connector height type.

XH5-N XH5A-N/XH5E-N

Plug, Terminal part SMT type, hold-down part THR type

Dimensions

CAD Data Please visit our CAD Data website, which is noted on the last page.

(Unit: mm)

XH5A-□□16-N
Plug, Right-angle
Terminal part SMT type,
hold-down part THR type

CAD Data

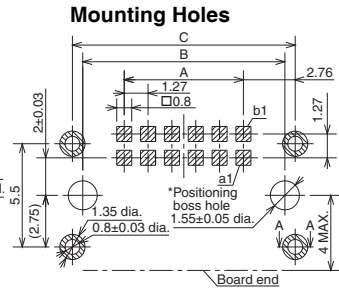
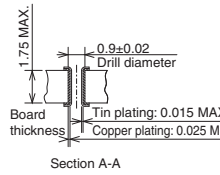
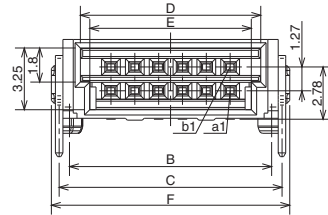
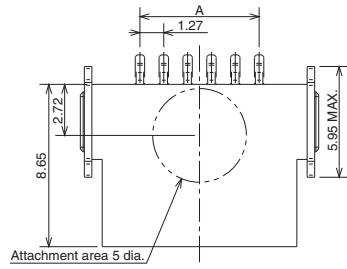
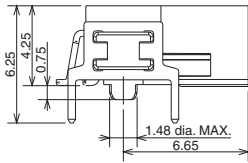

Pattern pitch tolerance
Note: The overall pattern pitch tolerance for the board is ± 0.03 . Do not accumulate error.
* The 1.55 ± 0.05 diameter holes are for the positioning bosses. Use metal masks to prevent solder from entering these holes.

Table of Dimensions

Model	Number of contacts	A	B	C	D	E	F
XH5A-1216-N	12	6.35	10.77	11.87	9.57	8.57	12.70
XH5A-2016-N	20	11.43	15.85	16.95	14.65	13.65	17.78
XH5A-2616-N	26	15.24	19.66	20.76	18.46	17.46	21.59
XH5A-3216-N	32	19.05	23.47	24.57	22.27	21.27	25.40
XH5A-4016-N	40	24.13	28.55	29.65	27.35	26.35	30.48
XH5A-5016-N	50	30.48	34.90	36.00	33.70	32.70	36.83
XH5A-6816-N	68	41.91	46.33	47.43	45.13	44.13	48.26
XH5A-8016-N	80	49.53	53.95	55.05	52.75	51.75	55.88

XH5E-□□16-□N
Plug, Straight
Terminal part SMT type,
hold-down part THR type

CAD Data

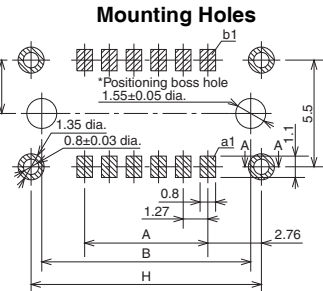
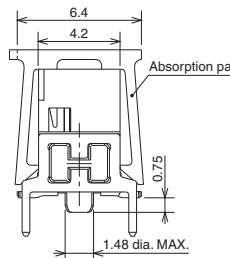
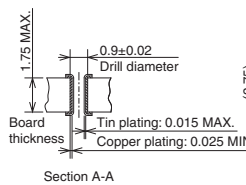
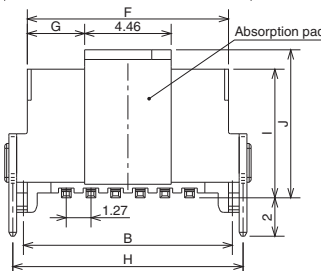
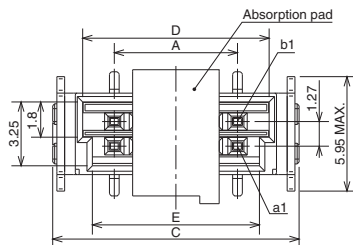

Pattern pitch tolerance
Note: The overall pattern pitch tolerance for the board is ± 0.03 . Do not accumulate error.
* The 1.55 ± 0.05 diameter holes are for the positioning bosses. Use metal masks to prevent solder from entering these holes.

Table of Dimensions

Model	Number of contacts	A	B	C	D	E	F	G	H	I	J
XH5E-1216-□N	12	6.35	10.77	12.70	9.57	8.57	10.37	2.96	11.87	1: 6.6 2: 8.1 3: 9.7	1: 7.6 2: 9.1 3: 10.7
XH5E-2016-□N	20	11.43	15.85	17.78	14.65	13.65	15.45	5.50	16.95		
XH5E-2616-□N	26	15.24	19.66	21.59	18.46	17.46	19.26	7.40	20.76		
XH5E-3216-□N	32	19.05	23.47	25.40	22.27	21.27	23.07	9.31	24.57		
XH5E-4016-□N	40	24.13	28.55	30.48	27.35	26.35	28.15	11.85	29.65		
XH5E-5016-□N	50	30.48	34.90	36.83	33.70	32.70	34.50	15.02	36.00		
XH5E-6816-□N	68	41.91	46.33	48.26	45.13	44.13	45.93	20.74	47.43		
XH5E-8016-□N	80	49.53	53.95	55.88	52.75	51.75	53.55	24.55	55.05		

Note: □ is replaced by 1 to 3 to indicate the connector height type.

Ordering Information

Plug, Right-angle
Terminal part/hold-down part SMT type



Number of contacts	Model	Quantity per reel (pcs)
12	XH5A-1215-N	560
20	XH5A-2015-N	
26	XH5A-2615-N	
32	XH5A-3215-N	
40	XH5A-4015-N	
50	XH5A-5015-N	
68	XH5A-6815-N	
80	XH5A-8015-N	

Plug, Straight
Terminal part/hold-down part SMT type

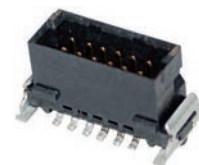

Number of contacts	Height (mm)	Model	Quantity per reel (pcs)
12	6.6	XH5E-1215-1N	280
	8.1	XH5E-1215-2N	280
	9.7	XH5E-1215-3N	250
20	6.6	XH5E-2015-1N	280
	8.1	XH5E-2015-2N	280
	9.7	XH5E-2015-3N	250
26	6.6	XH5E-2615-1N	280
	8.1	XH5E-2615-2N	280
	9.7	XH5E-2615-3N	250
32	6.6	XH5E-3215-1N	280
	8.1	XH5E-3215-2N	280
	9.7	XH5E-3215-3N	250
40	6.6	XH5E-4015-1N	280
	8.1	XH5E-4015-2N	280
	9.7	XH5E-4015-3N	250
50	6.6	XH5E-5015-1N	280
	8.1	XH5E-5015-2N	280
	9.7	XH5E-5015-3N	250
68	6.6	XH5E-6815-1N	280
	8.1	XH5E-6815-2N	280
	9.7	XH5E-6815-3N	250
80	6.6	XH5E-8015-1N	280
	8.1	XH5E-8015-2N	280
	9.7	XH5E-8015-3N	250

Plug, Right-angle
Terminal part SMT type, hold-down part THR type



Number of contacts	Model	Quantity per reel (pcs)
12	XH5A-1216-N	440
20	XH5A-2016-N	
26	XH5A-2616-N	
32	XH5A-3216-N	
40	XH5A-4016-N	
50	XH5A-5016-N	
68	XH5A-6816-N	
80	XH5A-8016-N	

Plug, Straight
Terminal part SMT type, hold-down part THR type



Number of contacts	Height (mm)	Model	Quantity per reel (pcs)
12	6.6	XH5E-1216-1N	220
	8.1	XH5E-1216-2N	
	9.7	XH5E-1216-3N	
20	6.6	XH5E-2016-1N	
	8.1	XH5E-2016-2N	
	9.7	XH5E-2016-3N	
26	6.6	XH5E-2616-1N	
	8.1	XH5E-2616-2N	
	9.7	XH5E-2616-3N	
32	6.6	XH5E-3216-1N	
	8.1	XH5E-3216-2N	
	9.7	XH5E-3216-3N	
40	6.6	XH5E-4016-1N	
	8.1	XH5E-4016-2N	
	9.7	XH5E-4016-3N	
50	6.6	XH5E-5016-1N	
	8.1	XH5E-5016-2N	
	9.7	XH5E-5016-3N	
68	6.6	XH5E-6816-1N	
	8.1	XH5E-6816-2N	
	9.7	XH5E-6816-3N	
80	6.6	XH5E-8016-1N	
	8.1	XH5E-8016-2N	
	9.7	XH5E-8016-3N	

XH5-N XH5F-N/XH5B-N

Socket, Terminal part/hold-down part SMT type

Dimensions

CAD Data Please visit our CAD Data website, which is noted on the last page.

(Unit: mm)

XH5F-□□15-N Socket, Right-angle Terminal part/hold-down part SMT type

CAD Data

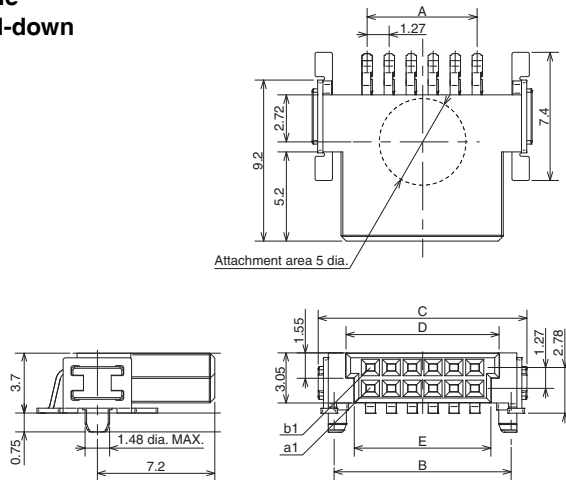

Mounting Holes

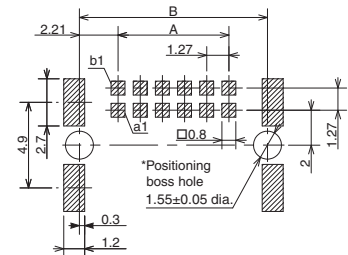

Pattern pitch tolerance

Note: The overall pattern pitch tolerance for the board is ± 0.03 . Do not accumulate error.

* The 1.55 ± 0.05 diameter holes are for the positioning bosses. Use metal masks to prevent solder from entering these holes.

Table of Dimensions

Model	Number of contacts	A	B	C	D	E
XH5F-1215-N	12	6.35	10.77	12.70	9.37	8.37
XH5F-2015-N	20	11.43	15.85	17.78	14.45	13.45
XH5F-2615-N	26	15.24	19.66	21.59	18.26	17.26
XH5F-3215-N	32	19.05	23.47	25.40	22.07	21.07
XH5F-4015-N	40	24.13	28.55	30.48	27.15	26.15
XH5F-5015-N	50	30.48	34.90	36.83	33.50	32.50
XH5F-6815-N	68	41.91	46.33	48.26	44.93	43.93
XH5F-8015-N	80	49.53	53.95	55.88	52.55	51.55

XH5B-□□15-□N Socket, Straight Terminal part/hold-down part SMT type

CAD Data

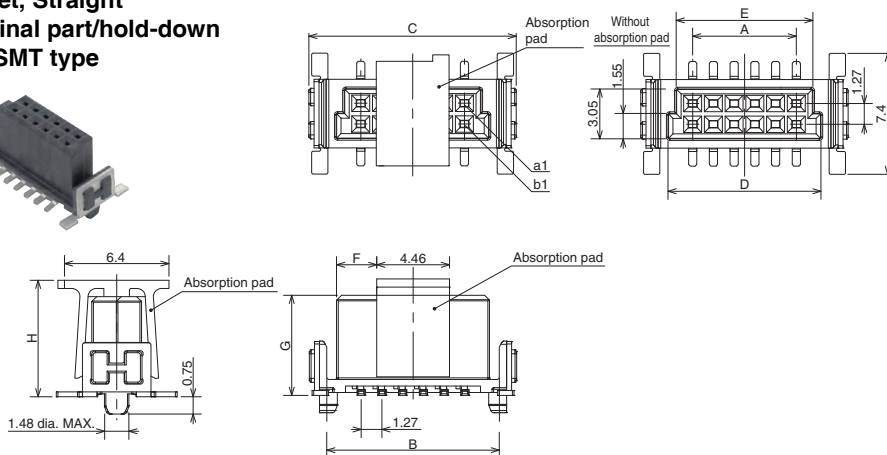
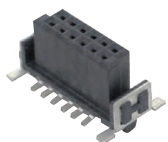

Mounting Holes

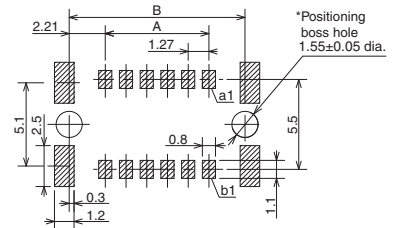

Pattern pitch tolerance

Note: The overall pattern pitch tolerance for the board is ± 0.03 . Do not accumulate error.

* The 1.55 ± 0.05 diameter holes are for the positioning bosses. Use metal masks to prevent solder from entering these holes.

Table of Dimensions

Model	Number of contacts	A	B	C	D	E	F	G	H
XH5B-1215-□N	12	6.35	10.77	12.70	9.37	8.37	2.46	4: 6.25 5: 9.05 6: 13.65	4: 7.1 5: 9.9 6: 14.5
XH5B-2015-□N	20	11.43	15.85	17.78	14.45	13.45	5.00		
XH5B-2615-□N	26	15.24	19.66	21.59	18.26	17.26	7.54		
XH5B-3215-□N	32	19.05	23.47	25.40	22.07	21.07	8.81		
XH5B-4015-□N	40	24.13	28.55	30.48	27.15	26.15	11.35		
XH5B-5015-□N	50	30.48	34.90	36.83	33.50	32.50	15.16		
XH5B-6815-□N	68	41.91	46.33	48.26	44.93	43.93	20.24		
XH5B-8015-□N	80	49.53	53.95	55.88	52.55	51.55	24.05		

Note: □ is replaced by 4 to 6 to indicate the connector height type.

XH5B-N

Socket, Terminal part SMT type, hold-down part THR type

Dimensions

CAD Data Please visit our CAD Data website, which is noted on the last page.

(Unit: mm)

XH5B-□□16-□N
 Socket, Straight
 Terminal part SMT type,
 hold-down part THR type

CAD Data

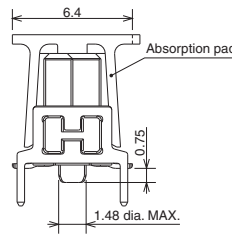
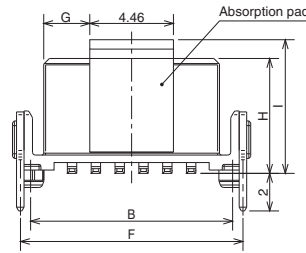
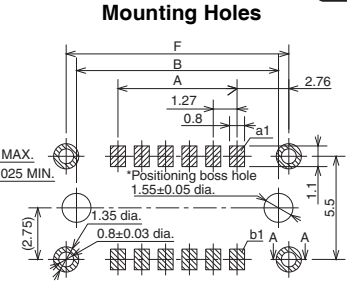
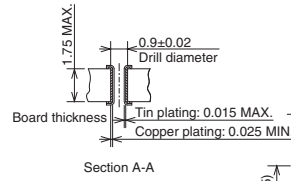
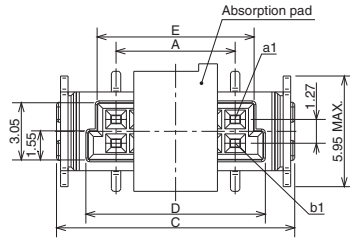

Pattern pitch tolerance

Note: The overall pattern pitch tolerance for the board is ±0.03. Do not accumulate error.

* The 1.55±0.05 diameter holes are for the positioning bosses. Use metal masks to prevent solder from entering these holes.

Table of Dimensions

Model	Number of contacts	A	B	C	D	E	F	G	H	I
XH5B-1216-□N	12	6.35	10.77	12.70	9.37	8.37	11.87	2.46	4: 6.25 5: 9.05 6: 13.65	4: 7.1 5: 9.9 6: 14.5
XH5B-2016-□N	20	11.43	15.85	17.78	14.45	13.45	16.95	5.00		
XH5B-2616-□N	26	15.24	19.66	21.59	18.26	17.26	20.76	7.54		
XH5B-3216-□N	32	19.05	23.47	25.40	22.07	21.07	24.57	8.81		
XH5B-4016-□N	40	24.13	28.55	30.48	27.15	26.15	29.65	11.35		
XH5B-5016-□N	50	30.48	34.90	36.83	33.50	32.50	36.00	15.16		
XH5B-6816-□N	68	41.91	46.33	48.26	44.93	43.93	47.43	20.24		
XH5B-8016-□N	80	49.53	53.95	55.88	52.55	51.55	55.05	24.05		

Note: □ is replaced by 4 to 6 to indicate the connector height type.

XH5-N

Ordering Information

Socket, Right-angle
Terminal part/hold-down part SMT type



Number of contacts	Model	Quantity per reel (pcs)
12	XH5F-1215-N	560
20	XH5F-2015-N	
26	XH5F-2615-N	
32	XH5F-3215-N	
40	XH5F-4015-N	
50	XH5F-5015-N	
68	XH5F-6815-N	
80	XH5F-8015-N	

Socket, Straight
Terminal part/hold-down part SMT type



Number of contacts	Height (mm)	Model	Quantity per reel (pcs)
12	6.25	XH5B-1215-4N	280
	9.05	XH5B-1215-5N	280
	13.65	XH5B-1215-6N	170
20	6.25	XH5B-2015-4N	280
	9.05	XH5B-2015-5N	280
	13.65	XH5B-2015-6N	170
26	6.25	XH5B-2615-4N	280
	9.05	XH5B-2615-5N	280
	13.65	XH5B-2615-6N	170
32	6.25	XH5B-3215-4N	280
	9.05	XH5B-3215-5N	280
	13.65	XH5B-3215-6N	170
40	6.25	XH5B-4015-4N	280
	9.05	XH5B-4015-5N	280
	13.65	XH5B-4015-6N	170
50	6.25	XH5B-5015-4N	280
	9.05	XH5B-5015-5N	280
	13.65	XH5B-5015-6N	170
68	6.25	XH5B-6815-4N	280
	9.05	XH5B-6815-5N	280
	13.65	XH5B-6815-6N	170
80	6.25	XH5B-8015-4N	280
	9.05	XH5B-8015-5N	280
	13.65	XH5B-8015-6N	170

Socket, Straight
Terminal part SMT type, hold-down part THR type



Number of contacts	Height (mm)	Model	Quantity per reel (pcs)
12	6.25	XH5B-1216-4N	220
	9.05	XH5B-1216-5N	
	13.65	XH5B-1216-6N	
20	6.25	XH5B-2016-4N	
	9.05	XH5B-2016-5N	
	13.65	XH5B-2016-6N	
26	6.25	XH5B-2616-4N	
	9.05	XH5B-2616-5N	
	13.65	XH5B-2616-6N	
32	6.25	XH5B-3216-4N	
	9.05	XH5B-3216-5N	
	13.65	XH5B-3216-6N	
40	6.25	XH5B-4016-4N	
	9.05	XH5B-4016-5N	
	13.65	XH5B-4016-6N	
50	6.25	XH5B-5016-4N	
	9.05	XH5B-5016-5N	
	13.65	XH5B-5016-6N	
68	6.25	XH5B-6816-4N	
	9.05	XH5B-6816-5N	
	13.65	XH5B-6816-6N	
80	6.25	XH5B-8016-4N	
	9.05	XH5B-8016-5N	
	13.65	XH5B-8016-6N	

XH5M-N/XH5T-N

XH5-N

Socket, IDC Type, Strain Relief

Dimensions

[CAD Data](#) Please visit our CAD Data website, which is noted on the last page.

(Unit: mm)

XH5M-□□10-N
Socket, IDC Type

[CAD Data](#)

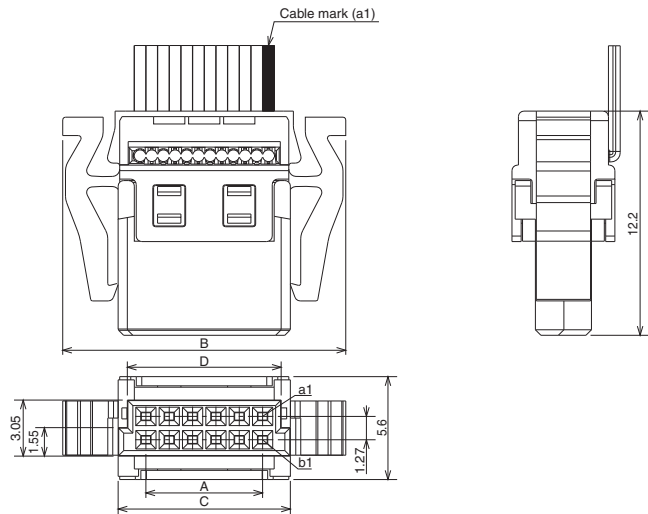

Table of Dimensions

Model	Number of contacts	A	B	C	D
XH5M-1210-N	12	6.35	15.40	9.37	8.37
XH5M-2010-N	20	11.43	20.48	14.45	13.45
XH5M-2610-N	26	15.24	24.29	18.26	17.26
XH5M-3210-N	32	19.05	28.10	22.07	21.07
XH5M-4010-N	40	24.13	33.18	27.15	26.15
XH5M-5010-N	50	30.48	39.53	33.50	32.50
XH5M-6810-N	68	41.91	50.96	44.93	43.93
XH5M-8010-N	80	49.53	58.58	52.55	51.55

XH5T-□□04-N
Strain Relief

[CAD Data](#)



12 pins to 50 pins

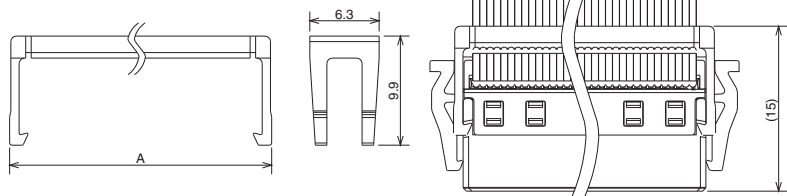

68 pins, 80 pins

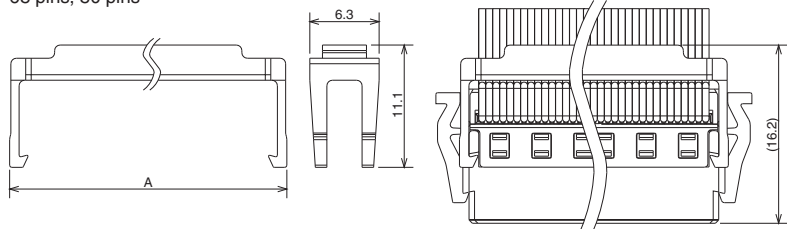

Table of Dimensions

Model	Number of contacts	A
XH5T-1204-N	12	11.12
XH5T-2004-N	20	16.20
XH5T-2604-N	26	20.01
XH5T-3204-N	32	23.82
XH5T-4004-N	40	28.90
XH5T-5004-N	50	35.25
XH5T-6804-N	68	46.68
XH5T-8004-N	80	54.30

XH5-N

Ordering Information

Socket, IDC Type



Number of contacts	Model	Minimum packaging unit (pcs)
12	XH5M-1210-N	100
20	XH5M-2010-N	105
26	XH5M-2610-N	120
32	XH5M-3210-N	100
40	XH5M-4010-N	100
50	XH5M-5010-N	75
68	XH5M-6810-N	50
80	XH5M-8010-N	50

Strain Relief



Number of contacts	Model	Minimum packaging unit (pcs)
12	XH5T-1204-N	100
20	XH5T-2004-N	100
26	XH5T-2604-N	100
32	XH5T-3204-N	100
40	XH5T-4004-N	100
50	XH5T-5004-N	75
68	XH5T-6804-N	75
80	XH5T-8004-N	50

Crimping Tool & Flat Cable for XH5M-N

Crimping Tool

Please contact your OMRON representative for crimping tool.

Flat Cable Specifications

For XH5M-N, use flat cables with the following specifications.

Flat Cable Specifications

Conductor	AWG30 (7/0.1) Tin-plated copper wire
Insulator	Soft vinyl chloride

Recommended Manufacturer

	OKI Electric Cable Model
0.635 mm-pitch flat cable	Bridge type: FLEX-B2()-7/0.1 20028 *1
	Blinds type: FLEX-S2()-7/0.1 7030 20028 *1

*1. The value in () represents the core number.
Consult OKI Electric Cable Co., Ltd. for details.

XH5H-N Cable with Connectors on Both Ends

Dimensions / Ordering Information

[CAD Data](#) Please visit our CAD Data website, which is noted on the last page. (Unit: mm)

XH5H-□□10-□□N

[CAD Data](#)

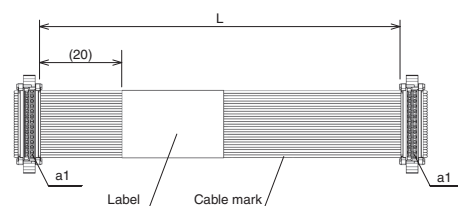

Table of Dimensions

Number of contacts	Length L (mm)	Model	Minimum packaging unit (pcs)	Number of contacts	Length L (mm)	Model	Minimum packaging unit (pcs)	
12	100	XH5H-1210-10N	10	40	100	XH5H-4010-10N	10	
	200	XH5H-1210-20N			200	XH5H-4010-20N		
	300	XH5H-1210-30N			300	XH5H-4010-30N		
	500	XH5H-1210-50N			500	XH5H-4010-50N		
	700	XH5H-1210-70N			700	XH5H-4010-70N		
	1000	XH5H-1210-1MN			1000	XH5H-4010-1MN		
20	100	XH5H-2010-10N		50	100	XH5H-5010-10N		10
	200	XH5H-2010-20N			200	XH5H-5010-20N		
	300	XH5H-2010-30N			300	XH5H-5010-30N		
	500	XH5H-2010-50N			500	XH5H-5010-50N		
	700	XH5H-2010-70N			700	XH5H-5010-70N		
	1000	XH5H-2010-1MN			1000	XH5H-5010-1MN		
26	100	XH5H-2610-10N	68	100	XH5H-6810-10N	10		
	200	XH5H-2610-20N		200	XH5H-6810-20N			
	300	XH5H-2610-30N		300	XH5H-6810-30N			
	500	XH5H-2610-50N		500	XH5H-6810-50N			
	700	XH5H-2610-70N		700	XH5H-6810-70N			
	1000	XH5H-2610-1MN		1000	XH5H-6810-1MN			
32	100	XH5H-3210-10N	80	100	XH5H-8010-10N	10		
	200	XH5H-3210-20N		200	XH5H-8010-20N			
	300	XH5H-3210-30N		300	XH5H-8010-30N			
	500	XH5H-3210-50N		500	XH5H-8010-50N			
	700	XH5H-3210-70N		700	XH5H-8010-70N			
	1000	XH5H-3210-1MN		1000	XH5H-8010-1MN			

XH5-N

Mating Diagram

(Unit: mm)

● Stacking connections

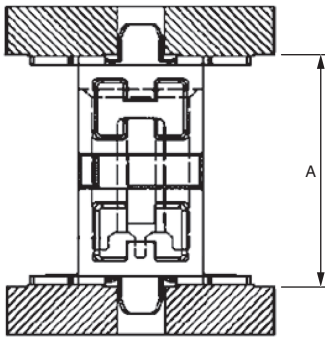

Model combination		A
Plug	Socket	
XH5E-□□1□-1N	XH5B-□□1□-4N	8.0
XH5E-□□1□-2N	XH5B-□□1□-4N	9.5
XH5E-□□1□-1N	XH5B-□□1□-5N	10.8
XH5E-□□1□-3N	XH5B-□□1□-4N	11.1
XH5E-□□1□-2N	XH5B-□□1□-5N	12.3
XH5E-□□1□-3N	XH5B-□□1□-5N	13.9
XH5E-□□1□-1N	XH5B-□□1□-6N	15.4
XH5E-□□1□-2N	XH5B-□□1□-6N	16.9
XH5E-□□1□-3N	XH5B-□□1□-6N	18.5

● Vertical connection

Plug, Right-angle
Socket, Straight

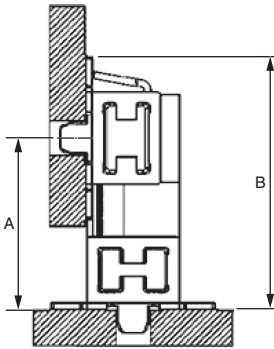

Model combination		A	B
Plug	Socket		
XH5A-□□1□-N	XH5B-□□1□-4N	7.7	11.53
	XH5B-□□1□-5N	10.5	14.33
	XH5B-□□1□-6N	15.10	18.93

Socket, Right-angle
Plug, Straight

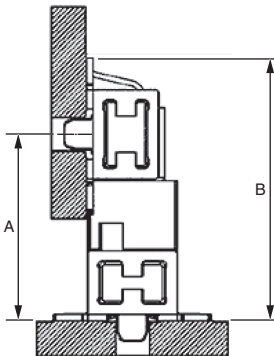

Model combination		A	B
Plug	Socket		
XH5E-□□1□-1N	XH5F-□□15-N	8.75	12.58
XH5E-□□1□-2N		10.25	14.08
XH5E-□□1□-3N		11.85	15.68

● Horizontal connection

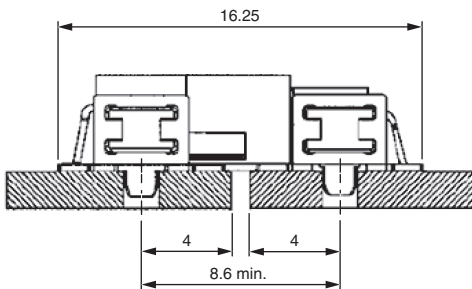

Model combination	
Plug	Socket
XH5A-□□1□-N	XH5F-□□15-N

Precautions

Precautions for Correct Use

● Soldering Conditions

• Recommended Reflow Conditions

Maximum temperature: 260°C

Time: Within 20 to 40 s

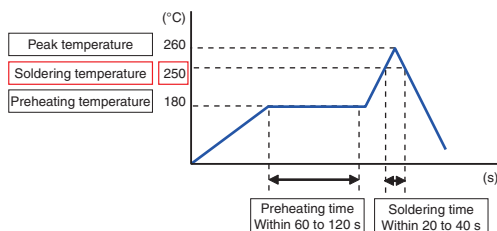

These conditions, however, depend on the type of solder, the manufacturer, the amount of solder, the size of the circuit board, and the other mounting materials. You must check and select the actual conditions.

● Metal Mask Thickness for Cream Solder Printing

We recommend a metal mask thickness of 0.18 to 0.20 mm for cream solder printing.

These conditions, however, depend on the type of solder, the manufacturer, the amount of solder, the size of the circuit board, and the other mounting materials. You must check and select the actual conditions.

● Pin Deformation

The pins will deform if you subject them to an excessive load. Deformed pins will reduce solderability when the connectors are mounted. Do not drop the connectors or handle them roughly. Do not connect or disconnect connectors that are not mounted to a circuit board. Doing so may deform the pins.

● In case of welding on the automatic welding groove after reflow

To prevent the rise of flux, mask the circuit board positioning boss holes with tape before you perform automatic soldering. If you mount connectors on the edges of the circuit boards, make sure that the solder surface does not come into contact with the connectors and that flux does not adhere to contact surfaces.

● Board Mounting Precautions

Be careful of board warping. Warping that is too severe may cause faulty soldering.

● Application Precautions

- Confirm that there is no excessive misalignment or inclination in the mating contact portion between the plug and socket before mating the connectors. Make sure that the connectors are mated all the way to the back. If the connectors are not mated all the way to the back, contact reliability may be lost.
- Do not apply an extreme load during connectors insertion or removal. The connectors may be damaged, and contact failure may result. Twist the plug and socket as little as possible when mating the connectors. Not doing so may deform the terminals or housing or crack the housing.
- Do not insert a foreign object, such as tweezers, into the connectors mating contact portion. Doing so may cause the plating to peel off or deforming of the terminals.
- When removing the harness, do not apply load to the flat cable. Otherwise, damage to the flat cable or the crimped part will result in poor contact.
- **Connector Crimping and Strain Relief Installation.**
 - The flat cable can be crimped only once. Do not remove the flat cable or the cover after crimping. Otherwise, damage or poor contact will occur.
 - After crimping, check that the claw of the cover housing is completely engaged. If the claw is not completely engaged, make some necessary adjustment. Incomplete engagement of the claw will result in poor contact.
 - The installation of the strain relief should be performed straightly. Inclined installation will result in damage.
 - Once installed, the strain relief cannot be removed. Forcibly removing it will result in damage.
 - Do not apply load by bundling the flat cable or bending it excessively. Otherwise, poor contact will occur.

● Storage

- (1) Do not store the connectors in locations subject to dust or high humidity.
- (2) Do not store the connectors in locations close to sources of gases such as ammonia or sulfide gases.

Approval Standard

The approval rating values for overseas standards are different from the performance values determined individually. Confirm the values before use.

Model	Standard	File No.	Rating
XH5A-□□15-N	UL certified product (Recognized)	E103202	-
XH5A-□□16-N	UL certified product (Recognized)	E103202	-
XH5E-□□15-□N	UL certified product (Recognized)	E103202	-
XH5E-□□16-□N	UL certified product (Recognized)	E103202	-
XH5F-□□15-N	UL certified product (Recognized)	E103202	-
XH5B-□□15-□N	UL certified product (Recognized)	E103202	-
XH5B-□□16-□N	UL certified product (Recognized)	E103202	-
XH5M-□□10-N	UL certified product (Recognized)	E103202	-
XH5T-□□04-N	Non Approved Models	-	-
XH5H-□□10-□□N	Non Approved Models	-	-

Please check each region's Terms & Conditions by region website.

OMRON Corporation

Device & Module Solutions Company

Regional Contact

Americas

<https://components.omron.com/us>

Asia-Pacific

<https://components.omron.com/ap>

Korea

<https://components.omron.com/kr>

Europe

<https://components.omron.com/eu>

China

<https://components.omron.com.cn>

Japan

<https://components.omron.com/jp>