

## FEATURES

- Combination Antenna (GPS & GLONASS + LTE)
- Triband Frequency
- RoHS Compliant

## APPLICATION

- Tracking
- Fleet Management

## SPECIFICATIONS

Electrical	
Frequency Range	1575.42 ~ 1602 MHz
Polarization	RHCP
Gain	2dBic (max)
V.S.W.R	< 1.5
Impedance	50Ω
LNA	
Gain	28 ± 2 dB
Noise Figure	< 2 dB
Supply Voltage	3 ~ 5VDC
Current Consumption	< 20 mA
V.S.W.R.	< 2.0
LTE	
Frequency Range	698~960 MHz 1710~2690 MHz
V.S.W.R	< 3.0
Polarization	Linear
Gain	2.5 dBi
Impedance	50Ω
Dimensions (mm):	
Diameter	81.3 ± 1.0
Width	14.6 ± 0.5
Height	15.0 ± 0.5
Cable Length	100
Cable	RG174
Connection Type	SMA
Mounting Method	Screw



**RoHS Compliant**  
includes all homogeneous materials  
(see part numbering system for details)

**NAN-E**   **A**   **81x14**   **B3**   **A**   **M**   **D**   **F**  
 ↳ F = RoHS compliant  
 ↳ D = RG174 Cable  
 ↳ M = SMA connector  
 ↳ A = Version Code (See Page 4)  
 ↳ B3 = 3 Frequency Band  
 ↳ 81x14 = Size (81.3 mm x 14.6 mm)  
 ↳ A = Active Antenna  
 ↳ NAN-E = Series

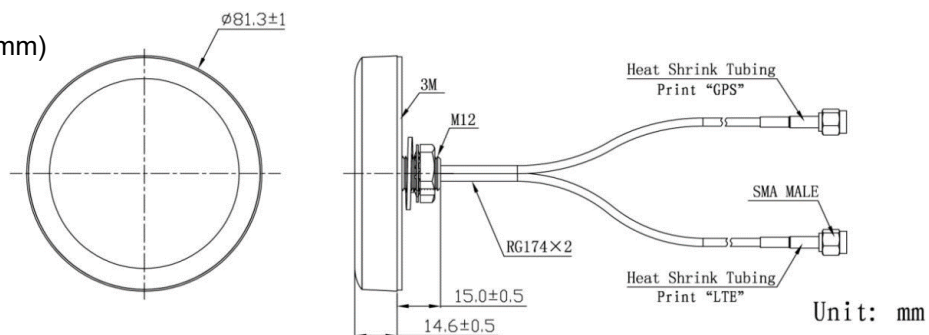

<b>Environmental</b>	
Operating Temperature	-40°C~+85°C
Relative Humidity	Up to 95%
Ingress Protection	IP67 (exclude cable outlet)
Vibration	10 ~ 55Hz 1.5mm Amplitude 2 Hours
RoHS Compliant	Yes

**RADIATION PATTERN**

**GPS&GLONASS**

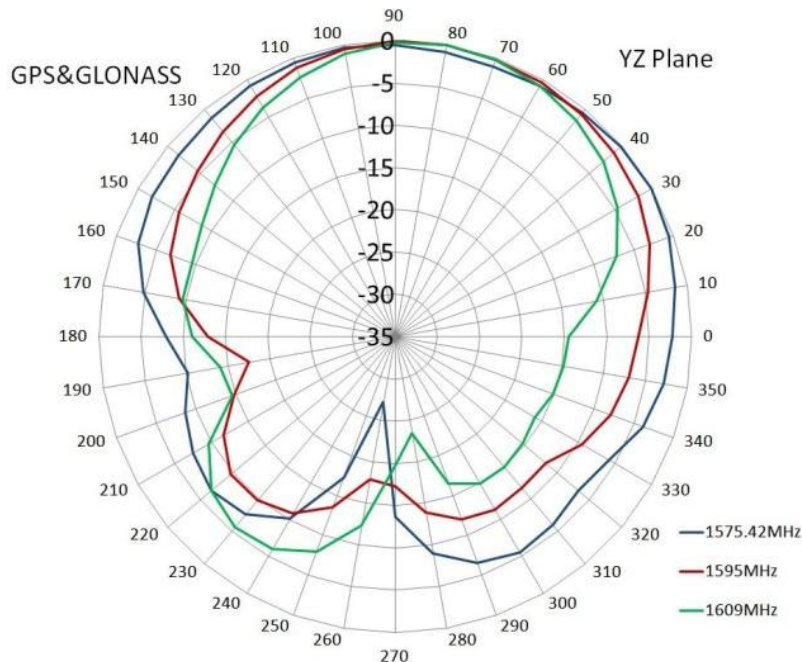
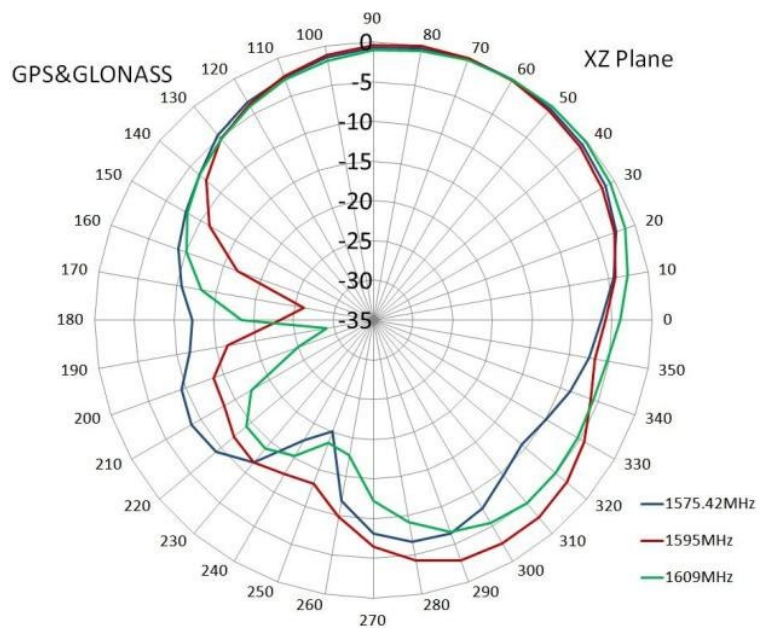
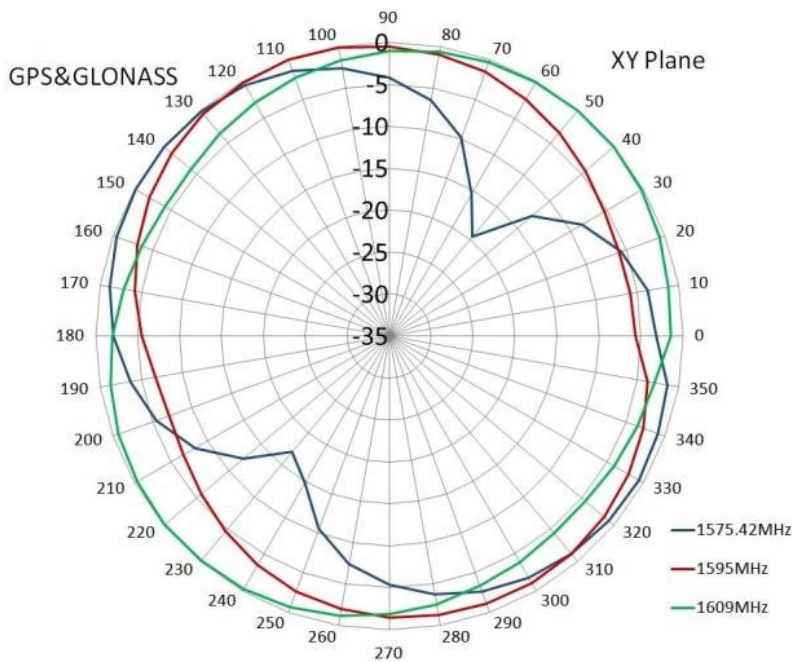

RADIATION PATTERN

LTE

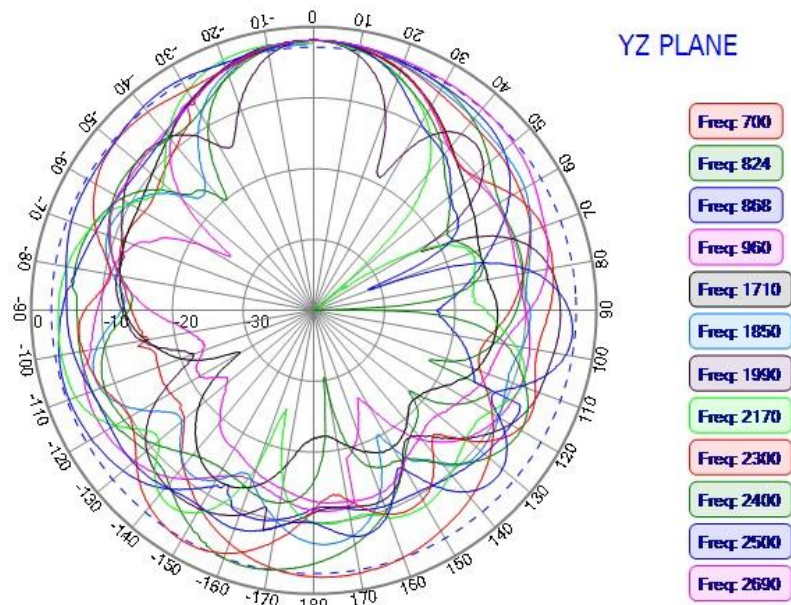
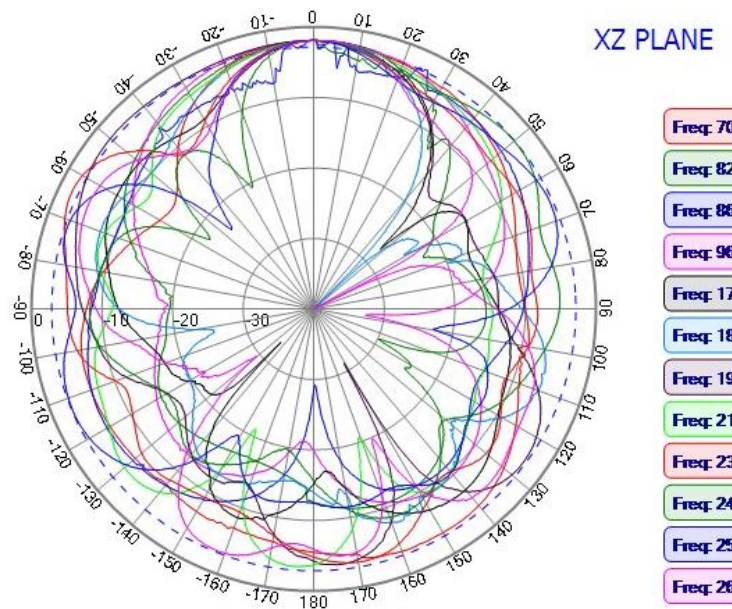
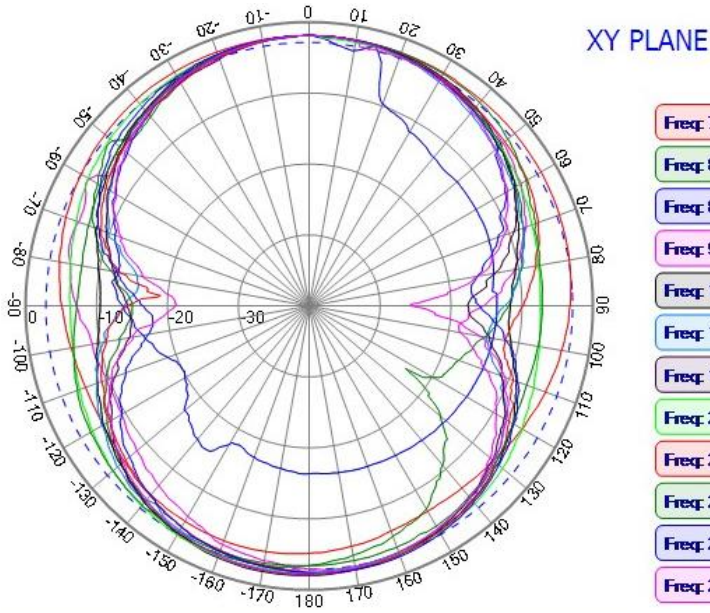

**Version History and Status**

Version	Date Issued	Details	Status
<b>A</b>	Nov 4 <sup>th</sup> , 2020	<b>Initial Release</b> Cable Length = 100mm	Supported
<b>B</b>	Nov 10 <sup>th</sup> , 2021	<b>New Release</b> Cable Length = 3m	Supported

Please reach out to NIC for any customization requests and other inquiries:

- NIC Technical Support: [tpmg@niccomp.com](mailto:tpmg@niccomp.com)
- Compliance Support: [rohs@niccomp.com](mailto:rohs@niccomp.com)