







PART NUMBER	CKTS	QUANTITY PER BAG	BAGS PER CARTON	PARTS PER CARTON (SPQ)	MOISTURIZATION METHOD 	PANEL LOCK
215922-0201	2	3000	4	12000	NO MOISTURIZATION	WITHOUT
215922-0401	4	2600	4	10400		
215922-0601	6	2000	4	8000		
215922-0801	8	1700	4	6800		
215922-1001	10	1400	4	5600		
215922-1201	12	1000	4	4000		
215922-1401	14	800	4	3200		
215922-1601	16	800	4	3200		
215922-1801	18	600	4	2400		
215922-2001	20	600	4	2400		
215922-2201	22	600	4	2400		
215922-2401	24	450	4	1800		
215922-0200	2	2000	4	8000	SEE SHEET 2	WITH
215922-0400	4	1800	4	7200		
215922-0600	6	1600	4	6400		
215922-0800	8	1100	4	4400		
215922-1000	10	1000	4	4000		
215922-1200	12	900	4	3600		
215922-1400	14	800	4	3200		
215922-1600	16	700	4	2800		
215922-1800	18	600	4	2400		
215922-2000	20	600	4	2400		
215922-2200	22	400	4	1600		
215922-2400	24	350	4	1400		

TBD: NO PRODUCTION, TO BE ADDED AFTER BEING PRODUCED.

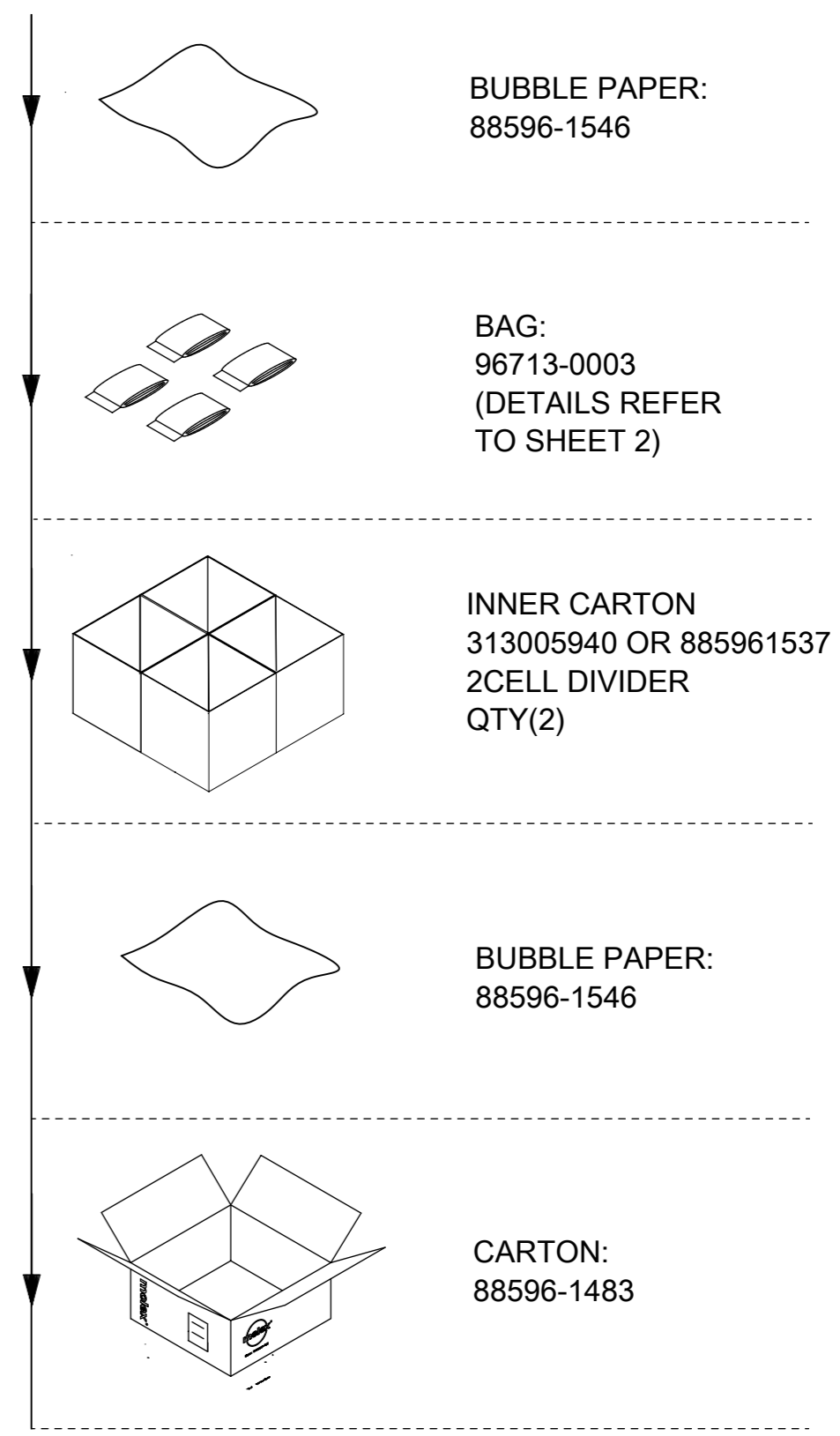
NOTES:

-  MOISTURIZATION METHOD DESCRIPTIONS REFER TO SHEET 2.
- STANDARD PACKAGE QUANTITY (SPQ) SEE ABOVE CHART.
- PACKAGE WAY FOLLOW RIGHT ILLUSTRATION.
- ALL PACKAGE MATERIAL AND PRODUCT COMPLIANT TO RoHS DIRECTIVE 2011/65/EU AND ELV DIRECTIVE 2000/53/EC.



FUNCTIONAL SYMBOLS	THIS DRAWING CONTAINS INFORMATION THAT IS PROPRIETARY TO MOLEX ELECTRONIC TECHNOLOGIES, LLC AND SHOULD NOT BE USED WITHOUT WRITTEN PERMISSION		CURRENT REV DESC:		molex			
	DIMENSION UNITS	SCALE						
 = 0	mm	1:1	GENERAL TOLERANCES (UNLESS SPECIFIED)		PACKING SPEC FOR MICRO-FIT PLUS WTW HSG			
 = 0	ANGULAR TOL ± °							
 = 0	4 PLACES ±							
DIVISIONAL SYMBOLS	3 PLACES ± 0.1							
	2 PLACES ± 0.3		EC NO: 725570 DRWN: GLLI 2022/08/29 CHK'D: XQZHANG 2022/10/31 APPR: XQZHANG 2022/10/31		PRODUCT CUSTOMER DRAWING			
	1 PLACE ± 0.5							
	0 PLACES ±							
DRAFT WHERE APPLICABLE MUST REMAIN WITHIN DIMENSIONS			THIRD ANGLE PROJECTION	DRAWING	SERIES	MATERIAL NUMBER	CUSTOMER	SHEET NUMBER
				A3-SIZE	215922	2159220000-PK		1 OF 2

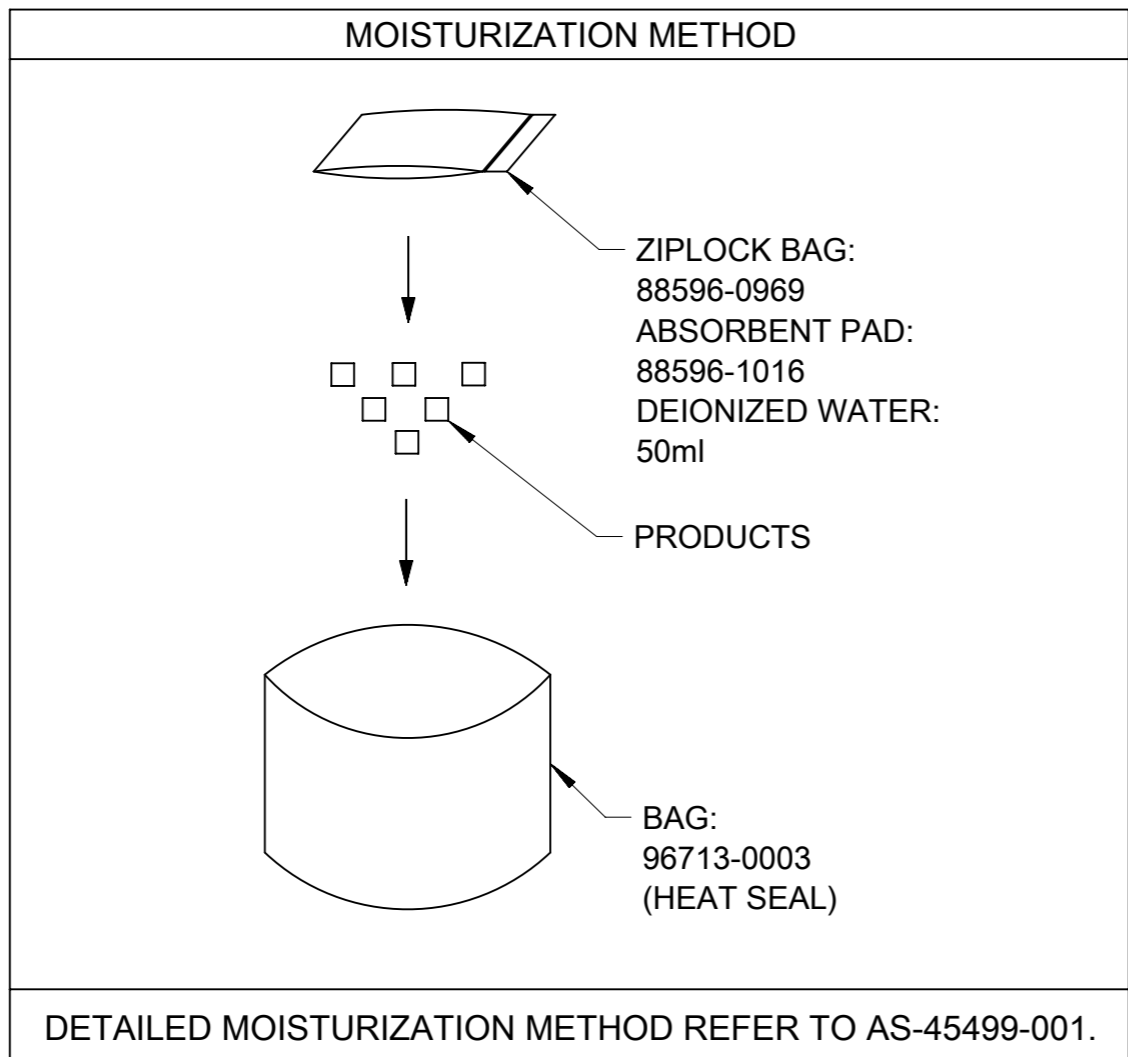

FUNCTIONAL SYMBOLS $\nabla_A = 0$ $\nabla_F = 0$ $\nabla_P = 0$	THIS DRAWING CONTAINS INFORMATION THAT IS PROPRIETARY TO MOLEX ELECTRONIC TECHNOLOGIES, LLC AND SHOULD NOT BE USED WITHOUT WRITTEN PERMISSION		<h1 style="margin: 0;">molex</h1>				
	DIMENSION UNITS	SCALE				PACKING SPEC FOR MICRO-FIT PLUS WTW HSG PRODUCT CUSTOMER DRAWING	
	mm	1:1					
	GENERAL TOLERANCES (UNLESS SPECIFIED)						
ANGULAR TOL ± °		EC NO: 725570 DRWN: GLLI 2022/08/29 CHK'D: XQZHANG 2022/10/31 APPR: XQZHANG 2022/10/31 INITIAL REVISION: DRWN: GLLI 2021/10/28 APPR: XQZHANG 2021/11/15					
4 PLACES ±							
3 PLACES ± 0.1							
2 PLACES ± 0.3							
1 PLACE ± 0.5		DOCUMENT NUMBER 2159220000-PK					
0 PLACES ±					DOC TYPE DOC PART REVISION PSD 000 B		
DRAFT WHERE APPLICABLE MUST REMAIN WITHIN DIMENSIONS		THIRD ANGLE PROJECTION	DRAWING	SERIES	MATERIAL NUMBER	CUSTOMER	SHEET NUMBER
			A3-SIZE	215922			2 OF 2

FREE HANGING PLUG PARTS

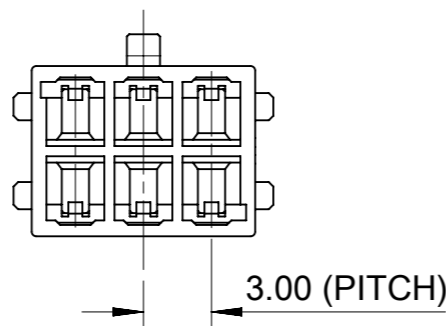
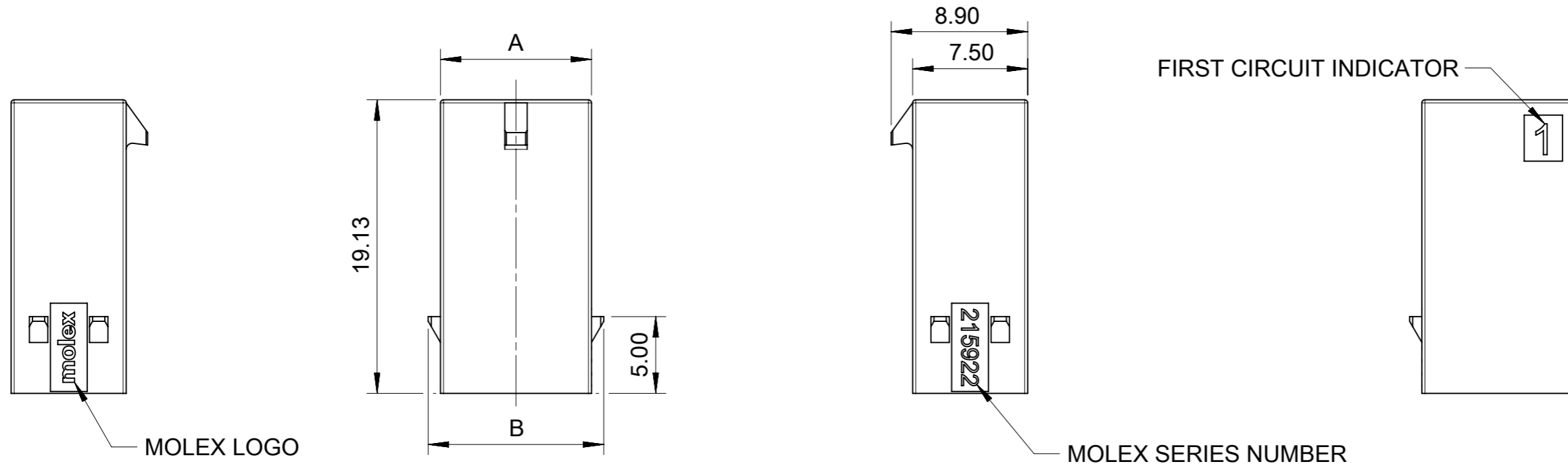

PART No	DIM'A'	DIM'B'	CKT SIZE
215922-0201	3.85	5.45	2
215922-0401	6.85	8.45	4
215922-0601	9.85	11.45	6
215922-0801	12.85	14.45	8
215922-1001	15.85	17.45	10
215922-1201	18.85	20.45	12
215922-1401	21.85	23.45	14
215922-1601	24.85	26.45	16
215922-1801	27.85	29.45	18
215922-2001	30.85	32.45	20
215922-2201	33.85	35.45	22
215922-2401	36.85	38.45	24

- NOTES:
1. MATERIAL: PA66, 94V-0, BLACK.
 2. PRODUCT SPECIFICATION: 2159530000-PS.
 3. PACKAGE SPECIFICATION: 2159220000-PK.
 4. TO USE WITH TERMINAL OF 2015953-****.
 5. TO USE WITH TPA OF 206462-****.
 6. TO MATE WITH RECEPTACLE OF 206461-****.
 7. PARTS CONFORM TO CLASS 'B' REQUIREMENTS OF COSMETIC SPECIFICATION PS-45499-002.

FUNCTIONAL SYMBOLS	THIS DRAWING CONTAINS INFORMATION THAT IS PROPRIETARY TO MOLEX ELECTRONIC TECHNOLOGIES, LLC AND SHOULD NOT BE USED WITHOUT WRITTEN PERMISSION		CURRENT REV DESC:		molex			
	DIMENSION UNITS	SCALE						
$\nabla_A = 0$	mm	1:1	EC NO: 712744 DRWN: GLLI 2022/07/01 CHK'D: XQZHANG 2022/07/05 APPR: XQZHANG 2022/07/05		PRODUCT CUSTOMER DRAWING			
$\nabla_E = 0$	GENERAL TOLERANCES (UNLESS SPECIFIED)				DOCUMENT NUMBER			
$\nabla_F = 0$	ANGULAR TOL ± °				INITIAL REVISION:		DOC TYPE	
DIVISIONAL SYMBOLS	4 PLACES ±		DRWN: GLLI 2021/01/29		2159220000-SD		PSD	
	3 PLACES ±		APPR: XQZHANG 2021/11/15				000	
	2 PLACES ±	0.2					A1	
	1 PLACE ±	0.3						
	0 PLACES ±							
	DRAFT WHERE APPLICABLE MUST REMAIN WITHIN DIMENSIONS		THIRD ANGLE PROJECTION	DRAWING	SERIES	MATERIAL NUMBER	CUSTOMER	SHEET NUMBER
				A3-SIZE	215922		GENERAL MARKET	1 OF 6

FREE HANGING PLUG PARTS

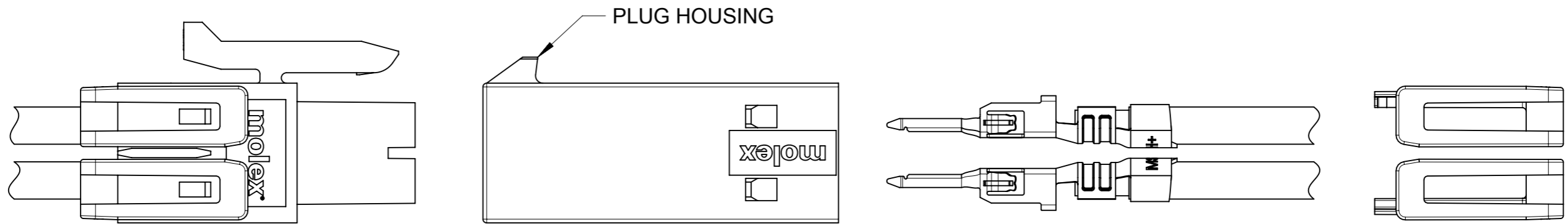
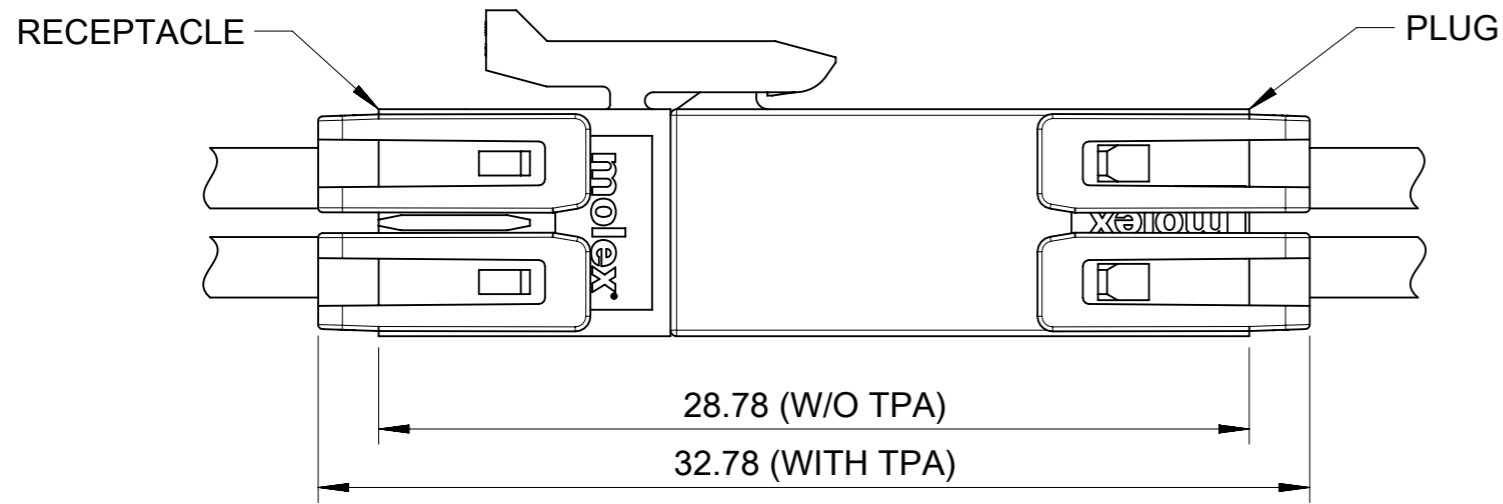

FUNCTIONAL SYMBOLS	THIS DRAWING CONTAINS INFORMATION THAT IS PROPRIETARY TO MOLEX ELECTRONIC TECHNOLOGIES, LLC AND SHOULD NOT BE USED WITHOUT WRITTEN PERMISSION		
	△/A = 0	mm	SCALE 1:1
DIVISIONAL SYMBOLS	CURRENT REV DESC:		
	△/E = 0	GENERAL TOLERANCES (UNLESS SPECIFIED)	
DIVISIONAL SYMBOLS	△/V = 0	ANGULAR TOL ± °	
		4 PLACES ±	EC NO: 712744
		3 PLACES ±	DRWN: GLLI 2022/07/01
		2 PLACES ± 0.2	CHK'D: XQZHANG 2022/07/05
		1 PLACE ± 0.3	APPR: XQZHANG 2022/07/05
	0 PLACES ±	INITIAL REVISION:	DOCUMENT NUMBER
		DRWN: GLLI 2021/01/29	2159220000-SD
		APPR: XQZHANG 2021/11/15	DOC TYPE
			PSD
			DOC PART
			000
			REVISION
			A1
			SHEET NUMBER
			2 OF 6

FREE HANGING PLUG PARTS

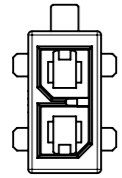

2 CKT

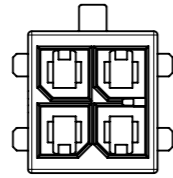

4 CKT

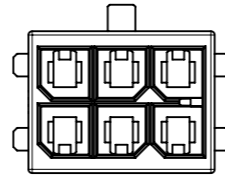

6 CKT

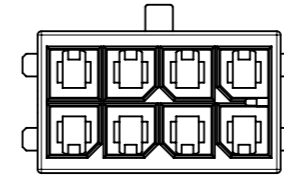

8 CKT

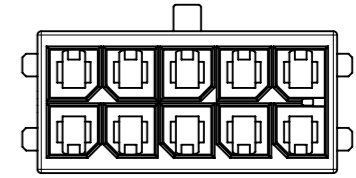

10 CKT

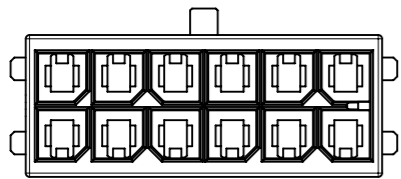

12 CKT

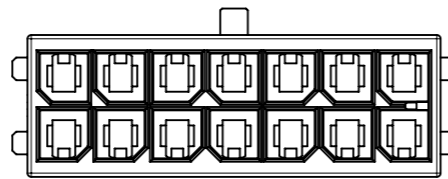

14 CKT

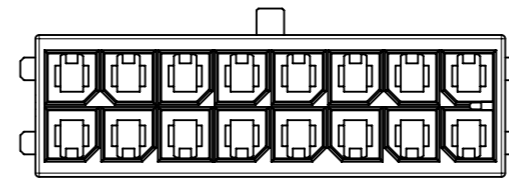

16 CKT

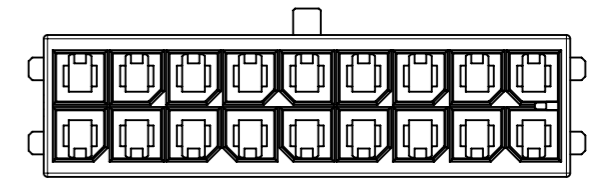

18 CKT

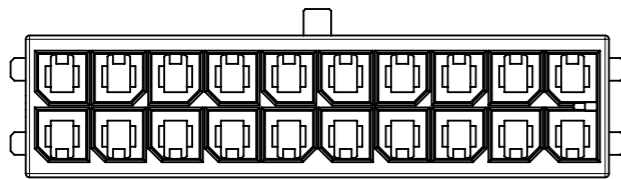

20 CKT

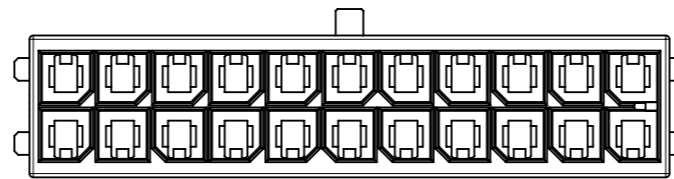

22 CKT

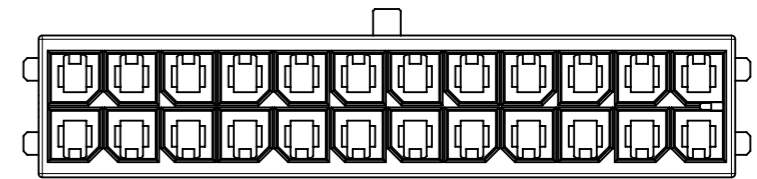

24 CKT

FUNCTIONAL SYMBOLS	THIS DRAWING CONTAINS INFORMATION THAT IS PROPRIETARY TO MOLEX ELECTRONIC TECHNOLOGIES, LLC AND SHOULD NOT BE USED WITHOUT WRITTEN PERMISSION		CURRENT REV DESC:					
	$\nabla_A = 0$ $\nabla_E = 0$ $\nabla_V = 0$	DIMENSION UNITS mm						
DIVISIONAL SYMBOLS	4 PLACES	±	EC NO: 712744		PRODUCT CUSTOMER DRAWING			
	3 PLACES	±	DRWN: GLLI 2022/07/01					
	2 PLACES	± 0.2	CHK'D: XQZHANG 2022/07/05					
	1 PLACE	± 0.3	APPR: XQZHANG 2022/07/05					
	0 PLACES	±	INITIAL REVISION:		DOCUMENT NUMBER	DOC TYPE	DOC PART	REVISION
DRAFT WHERE APPLICABLE MUST REMAIN WITHIN DIMENSIONS		THIRD ANGLE PROJECTION		DRAWING	SERIES	MATERIAL NUMBER	CUSTOMER	SHEET NUMBER
				A3-SIZE	215922	2159220000-SD	GENERAL MARKET	3 OF 6

PANEL MOUNT PLUG PARTS

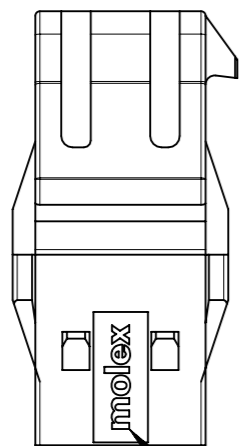

MOLEX LOGO

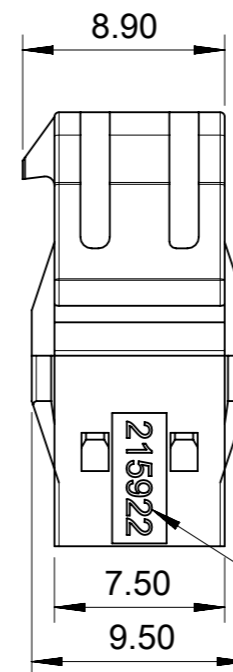
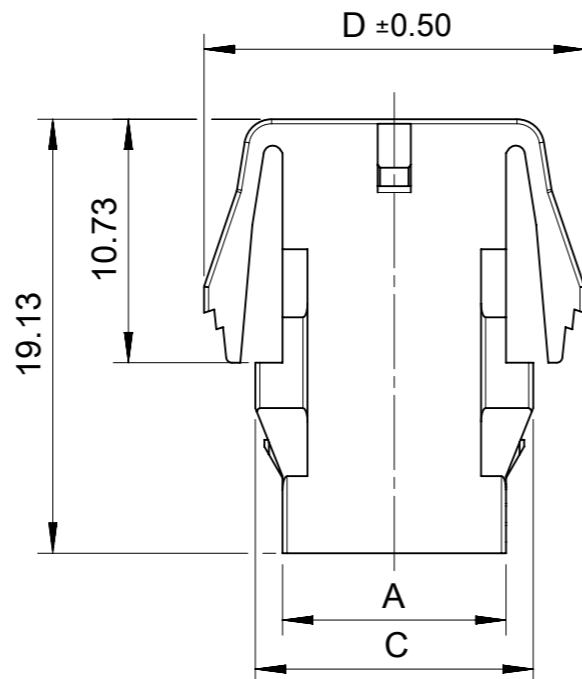

FIRST CIRCUIT INDICATOR

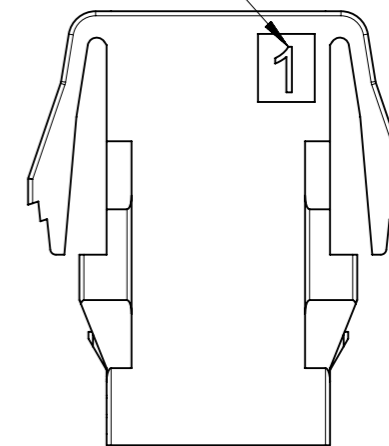

MOLEX SERIES NUMBER

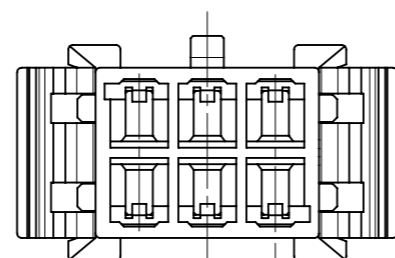

3.00 (PITCH)

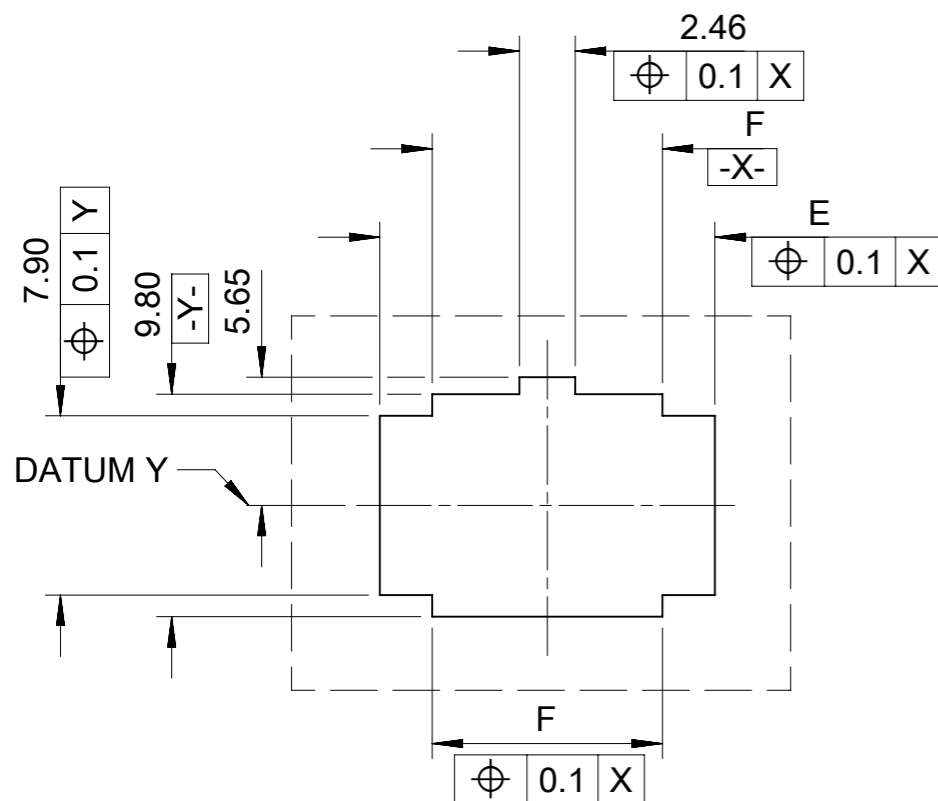

RECOMMENDED PANEL CUT OUT
(TOLERANCE +/-0.05 THICKNESS=1.2~2.2MM)

PART No	DIM 'A'	DIM 'C'	DIM 'D'	DIM 'E'	DIM 'F'	CKT SIZE
215922-0200	3.85	6.25	10.77	8.77	4.15	2
215922-0400	6.85	9.25	13.77	11.77	7.15	4
215922-0600	9.85	12.25	16.77	14.77	10.15	6
215922-0800	12.85	15.25	19.77	17.77	13.15	8
215922-1000	15.85	18.25	22.77	20.77	16.15	10
215922-1200	18.85	21.25	25.77	23.77	19.15	12
215922-1400	21.85	24.25	28.77	26.77	22.15	14
215922-1600	24.85	27.25	31.77	29.77	25.15	16
215922-1800	27.85	30.25	34.77	32.77	28.15	18
215922-2000	30.85	33.25	37.77	35.77	31.15	20
215922-2200	33.85	36.25	40.77	38.77	34.15	22
215922-2400	36.85	39.25	43.77	41.77	37.15	24

FUNCTIONAL SYMBOLS	THIS DRAWING CONTAINS INFORMATION THAT IS PROPRIETARY TO MOLEX ELECTRONIC TECHNOLOGIES, LLC AND SHOULD NOT BE USED WITHOUT WRITTEN PERMISSION	CURRENT REV DESC:																											
	<table border="1"> <tr> <th>FUNCTIONAL SYMBOLS</th> <th>DIMENSION UNITS</th> <th>SCALE</th> </tr> <tr> <td>$\nabla_A = 0$</td> <td>mm</td> <td>1:1</td> </tr> <tr> <td>$\nabla_E = 0$</td> <td colspan="2">GENERAL TOLERANCES (UNLESS SPECIFIED)</td> </tr> <tr> <td>$\nabla_{E'} = 0$</td> <td colspan="2">ANGULAR TOL ± °</td> </tr> <tr> <td rowspan="5">DIVISIONAL SYMBOLS</td> <td>4 PLACES</td> <td>±</td> </tr> <tr> <td>3 PLACES</td> <td>±</td> </tr> <tr> <td>2 PLACES</td> <td>± 0.2</td> </tr> <tr> <td>1 PLACE</td> <td>± 0.3</td> </tr> <tr> <td>0 PLACES</td> <td>±</td> </tr> </table>	FUNCTIONAL SYMBOLS	DIMENSION UNITS					SCALE	$\nabla_A = 0$	mm	1:1	$\nabla_E = 0$	GENERAL TOLERANCES (UNLESS SPECIFIED)		$\nabla_{E'} = 0$	ANGULAR TOL ± °		DIVISIONAL SYMBOLS	4 PLACES	±	3 PLACES	±	2 PLACES	± 0.2	1 PLACE	± 0.3	0 PLACES	±	EC NO: 712744 DRWN: GLLI 2022/07/01 CHK'D: XQZHANG 2022/07/05 APPR: XQZHANG 2022/07/05
FUNCTIONAL SYMBOLS	DIMENSION UNITS	SCALE																											
$\nabla_A = 0$	mm	1:1																											
$\nabla_E = 0$	GENERAL TOLERANCES (UNLESS SPECIFIED)																												
$\nabla_{E'} = 0$	ANGULAR TOL ± °																												
DIVISIONAL SYMBOLS	4 PLACES	±																											
	3 PLACES	±																											
	2 PLACES	± 0.2																											
	1 PLACE	± 0.3																											
	0 PLACES	±																											
PRODUCT CUSTOMER DRAWING				DOCUMENT NUMBER																									
INITIAL REVISION:				2021/01/29		2021/11/15																							
DRWN: GLLI 2021/01/29				2021/11/15		2021/11/15																							
APPR: XQZHANG				2021/11/15		2021/11/15																							
DRAFT WHERE APPLICABLE MUST REMAIN WITHIN DIMENSIONS				THIRD ANGLE PROJECTION	DRAWING	SERIES	MATERIAL NUMBER																						
					A3-SIZE	215922	2159220000-SD																						
				CUSTOMER	GENERAL MARKET																								
				SHEET NUMBER		4 OF 6																							

PANEL MOUNT PLUG PARTS

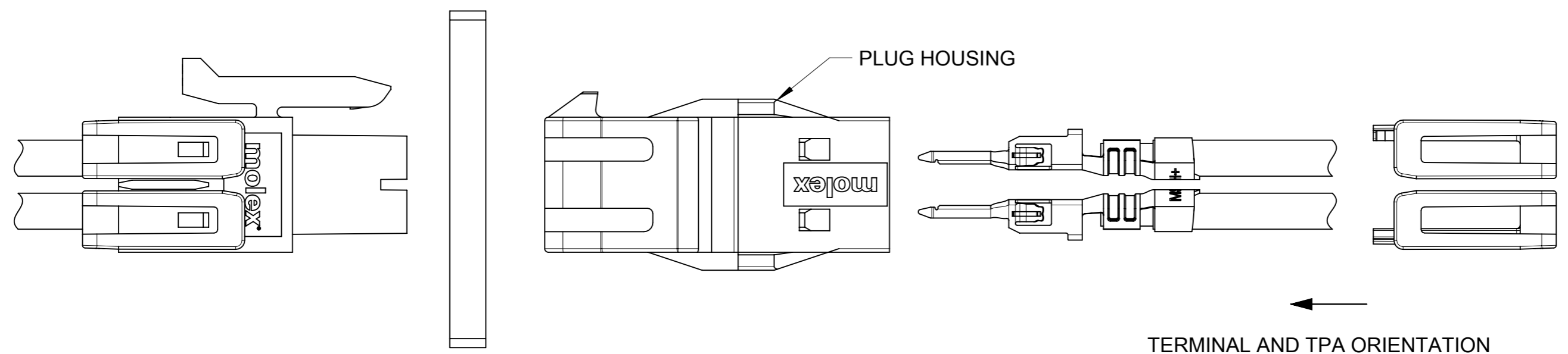
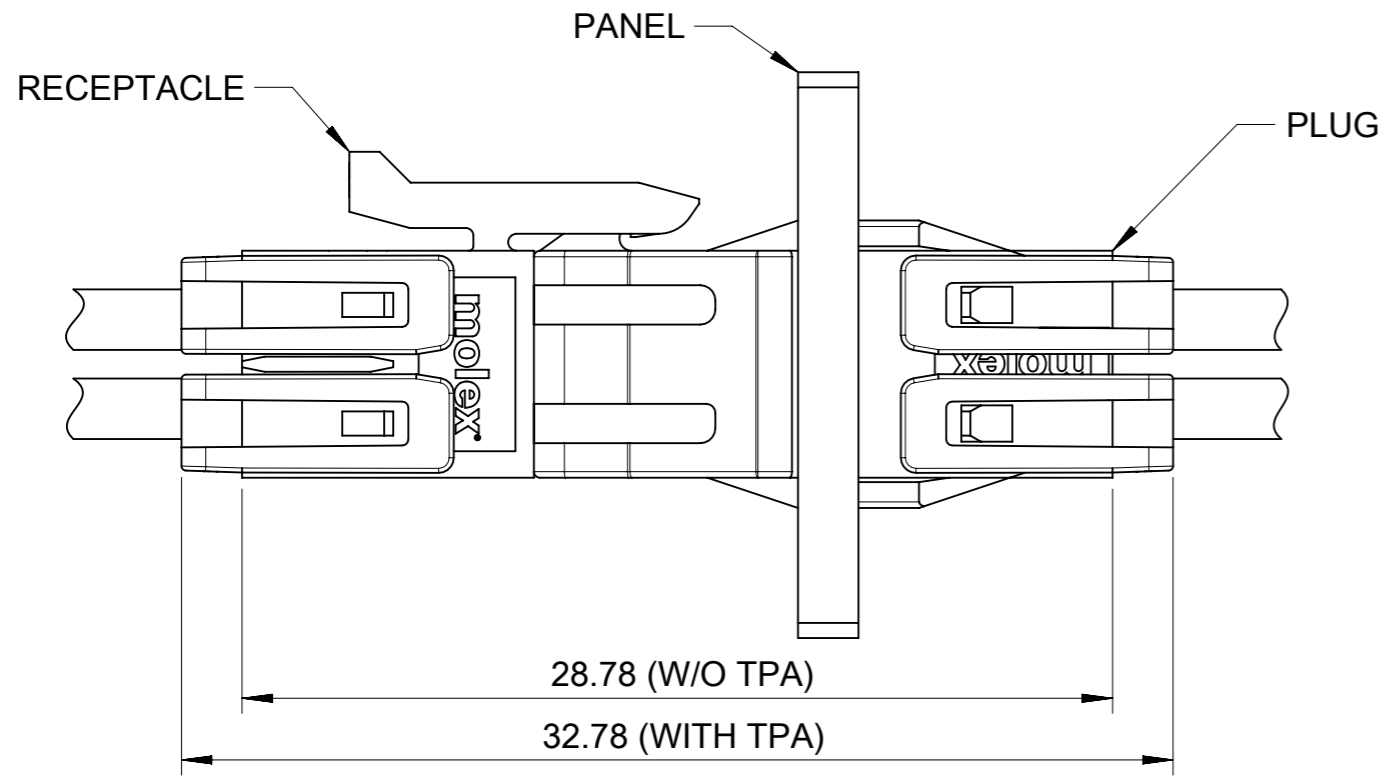

FUNCTIONAL SYMBOLS	THIS DRAWING CONTAINS INFORMATION THAT IS PROPRIETARY TO MOLEX ELECTRONIC TECHNOLOGIES, LLC AND SHOULD NOT BE USED WITHOUT WRITTEN PERMISSION		CURRENT REV DESC:		molex					
	▽A = 0	mm							SCALE 1:1	
▽E = 0	GENERAL TOLERANCES (UNLESS SPECIFIED)		EC NO: 712744 DRWN: GLLI 2022/07/01 CHK'D: XQZHANG 2022/07/05 APPR: XQZHANG 2022/07/05		PLUG HOUSING OF MICRO-FIT PLUS WTW DR POWER CONNECTOR					
▽P = 0	ANGULAR TOL ± °				PRODUCT CUSTOMER DRAWING					
DIVISIONAL SYMBOLS	4 PLACES ±				INITIAL REVISION:		DOCUMENT NUMBER	DOC TYPE	DOC PART	REVISION
	3 PLACES ±				DRWN: GLLI 2021/01/29		2159220000-SD	PSD	000	A1
	2 PLACES ±	0.2	APPR: XQZHANG 2021/11/15		MATERIAL NUMBER	CUSTOMER		SHEET NUMBER		
	1 PLACE ±	0.3	DRAFT WHERE APPLICABLE MUST REMAIN WITHIN DIMENSIONS		A3-SIZE	GENERAL MARKET		5 OF 6		
	0 PLACES ±		THIRD ANGLE PROJECTION		SERIES					
			DRAWING		215922					

PANEL MOUNT PLUG PARTS

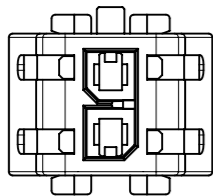

2 CKT

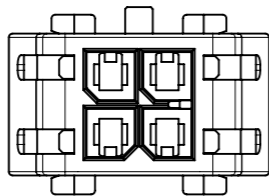

4 CKT

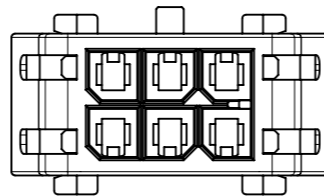

6 CKT

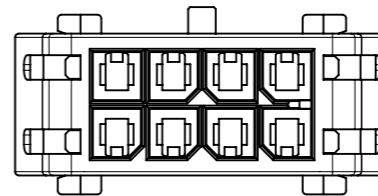

8 CKT

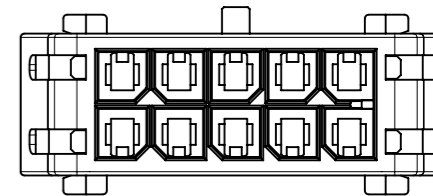

10 CKT

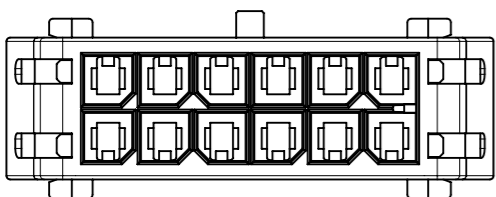

12 CKT

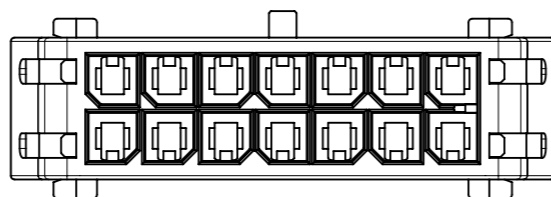

14 CKT

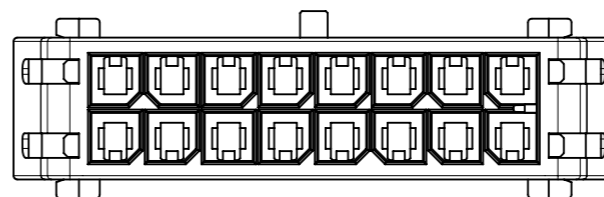

16 CKT

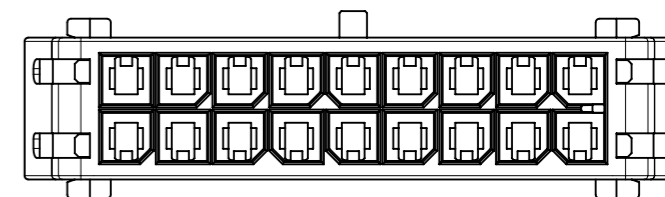

18 CKT

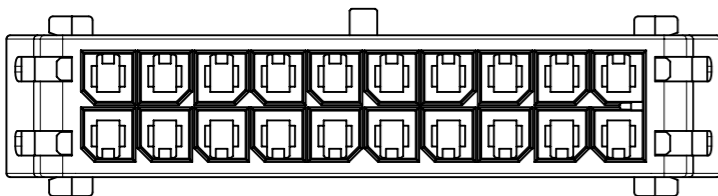

20 CKT

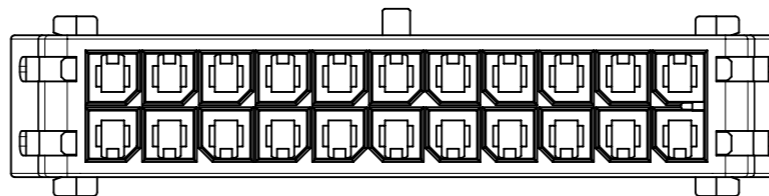

22 CKT

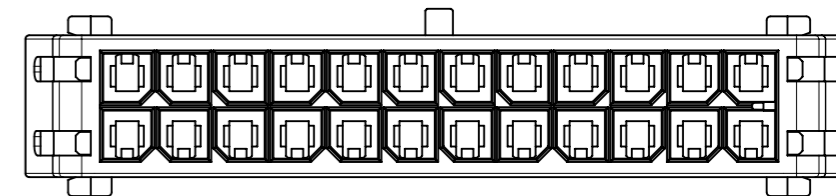

24 CKT

FUNCTIONAL SYMBOLS	THIS DRAWING CONTAINS INFORMATION THAT IS PROPRIETARY TO MOLEX ELECTRONIC TECHNOLOGIES, LLC AND SHOULD NOT BE USED WITHOUT WRITTEN PERMISSION		<div style="text-align: center;">molex</div> PLUG HOUSING OF MICRO-FIT PLUS WTW DR POWER CONNECTOR							
	DIMENSION UNITS mm	SCALE 1:1					CURRENT REV DESC:		DOCUMENT NUMBER	DOC TYPE
	GENERAL TOLERANCES (UNLESS SPECIFIED)		EC NO: 712744		2022/07/01			PRODUCT CUSTOMER DRAWING 2159220000-SD PSD 000 A1		
	ANGULAR TOL ± °		DRWN: GLLI		2022/07/05					
	4 PLACES ±		CHK'D: XQZHANG		2022/07/05					
DIVISIONAL SYMBOLS	3 PLACES ±		APPR: XQZHANG		INITIAL REVISION:					
	2 PLACES ± 0.2		DRWN: GLLI		2021/01/29					
	1 PLACE ± 0.3		APPR: XQZHANG		2021/11/15					
	0 PLACES ±		DRAFT WHERE APPLICABLE MUST REMAIN WITHIN DIMENSIONS		THIRD ANGLE PROJECTION	DRAWING	SERIES	MATERIAL NUMBER	CUSTOMER	SHEET NUMBER
						A3-SIZE	215922		GENERAL MARKET	6 OF 6