



AEC-Q200
 This component was always
 RoHS compliant from the first
 date of manufacture.

- Surface Mount 3.0 x 3.0 x 1.3 mm Package
- Complies with Directive 2002/95/EC (RoHS)



SF2202E

**2017.5 MHz
 SAW Filter**

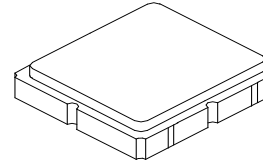

SM3030-6

Absolute Maximum Ratings

Rating	Value	Units
Input Power Level	10	dBm
DC Voltage on any Non-ground Terminal	3	V
Operating Temperature Range	-30 to +85	°C
Storage Temperature Range in Tape and Reel	-40 to +85	°C
Solder Reflow Temperature, 10 seconds, 5 cycles maximum	260	°C

Electrical Characteristics

Characteristic	Sym	Notes	Min	Typ	Max	Units
Center Frequency	F_C			2017.5		MHz
Insertion Loss, 2010 to 2025 MHz	IL			2.9	4.0	dB
Amplitude Ripple, 2010 to 2025 MHz				0.5	1.5	dB
VSWR, 2010 to 2025 MHz				2.0	2.5	
Group Delay Ripple, 2010 to 2025 MHz				4.0	25	ns
Attenuation, Referenced to 0 dB						
D.C. to 1200 MHz			40	48		dB
1200 to 1860 MHz			33	38		
1920 to 1980 MHz			13	28		
2045 to 2070 MHz			6	17		
2070 to 2085 MHz			26	39		
2085 to 2800 MHz			30	35		
2800 to 4000 MHz			22	30		
Source Impedance	Z_S			50		Ω
Load Impedance	Z_L			50		
Case Style	SM3030-6 3.0 x 3.0 mm Nominal Footprint					
Lid Symbolization (Y=year, WW=week, S=shift) dot=pin 1 indicator	932, YWWS					
Standard Reel Quantity	Reel Size 7 Inch					500 Pieces/Reel
	Reel Size 13 Inch					3000 Pieces/Reel



CAUTION: Electrostatic Sensitive Device. Observe precautions for handling.

NOTES:

1. The design, manufacturing process, and specifications of this device are subject to change.
2. US or International patents may apply.

Frequency Characteristics

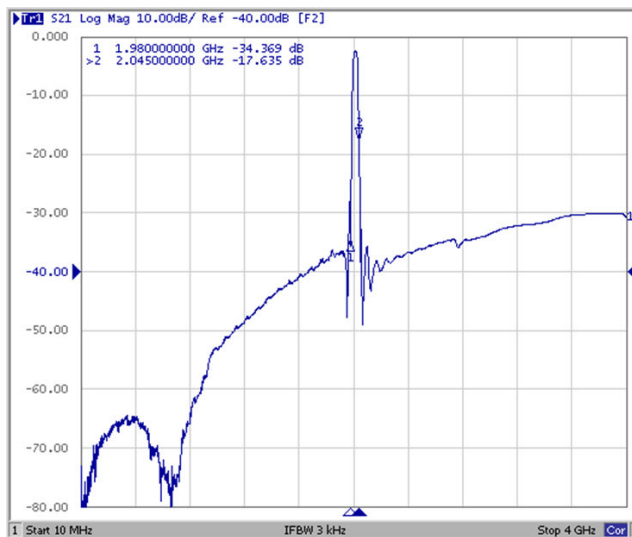
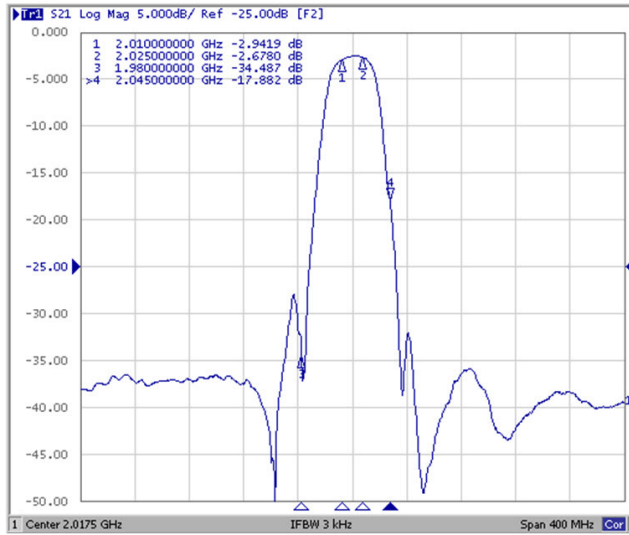
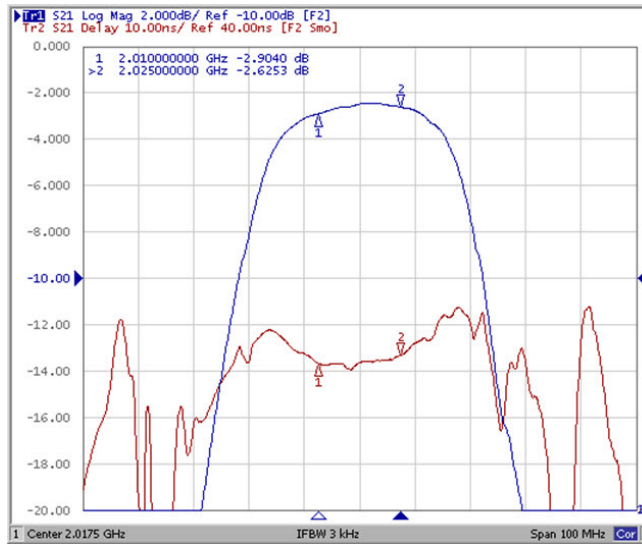

Reflection Functions

S11

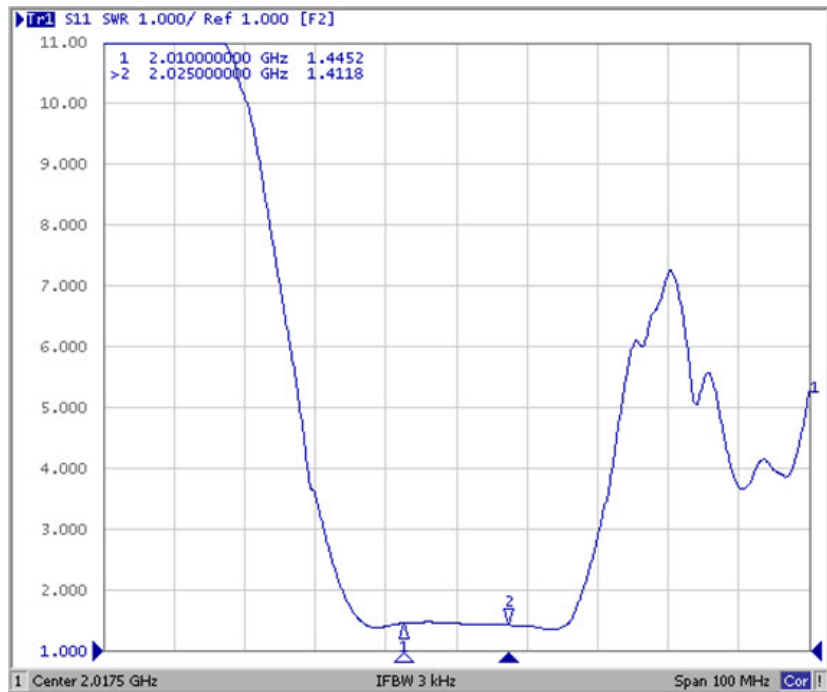

S22

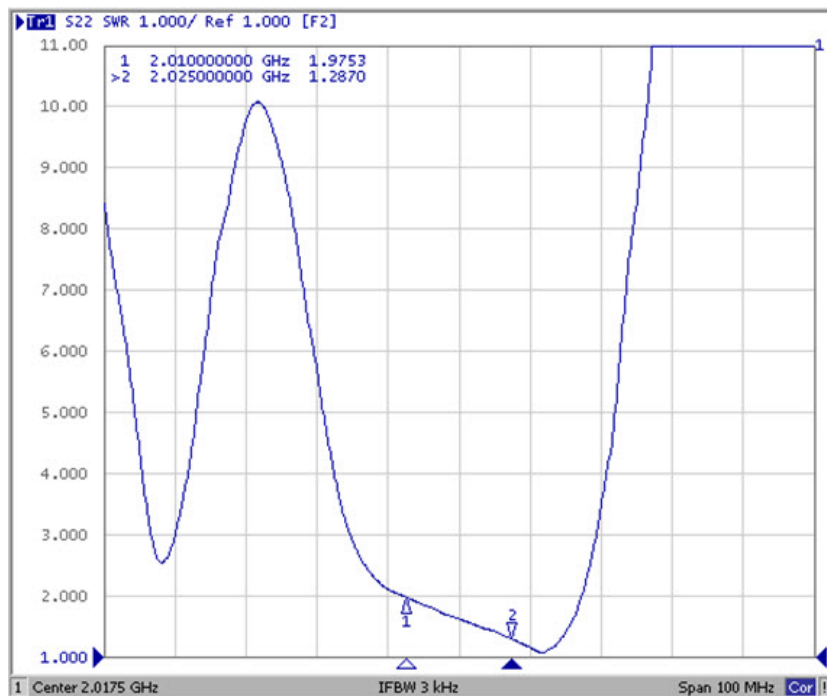

SM3030-6 Case

6-Terminal Ceramic Surface-Mount Case 3.0 X 3.0 mm Nominal Footprint



PCB Footprint Top View

Case and PCB Footprint Dimensions

Dimension	mm			Inches		
	Min	Nom	Max	Min	Nom	Max
A	2.87	3.00	3.13	0.113	0.118	0.123
B	2.87	3.00	3.13	0.113	0.118	0.123
C	1.12	1.25	1.38	0.044	0.049	0.054
D	0.77	0.90	1.03	0.030	0.035	0.040
E	2.67	2.80	2.93	0.105	0.110	0.115
F	1.47	1.60	1.73	0.058	0.063	0.068
G	0.72	0.85	0.98	0.028	0.033	0.038
H	1.37	1.50	1.63	0.054	0.059	0.064
I	0.47	0.60	0.73	0.019	0.024	0.029
J	1.17	1.30	1.43	0.046	0.051	0.056
K	-	3.20	-	-	0.126	-
L	-	1.70	-	-	0.067	-
M	-	1.05	-	-	0.041	-
N	-	0.81	-	-	0.032	-
O	-	0.38	-	-	0.015	-

Case Materials

Materials	
Solder Pad Plating	0.3 to 1.0 μm Gold over 1.27 to 8.89 μm Nickel
Lid Plating	2.0 to 3.0 μm Nickel
Body	Al_2O_3 Ceramic
Pb Free	

Electrical Connections

Connection	Terminals
Input	5
Output	2
Ground	All Others

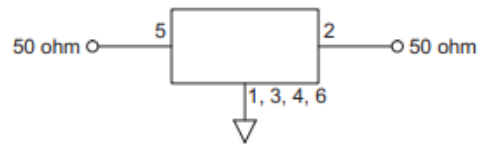

TOP VIEW

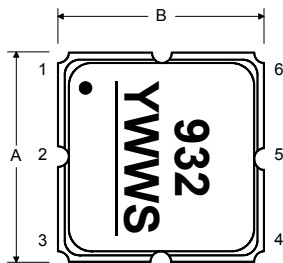

BOTTOM VIEW

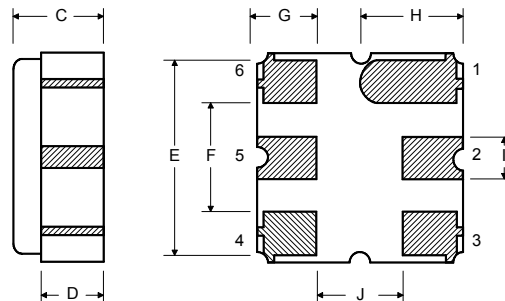

Tape and Reel Specifications

Tape and Reel Standard per ANSI/EIA-481

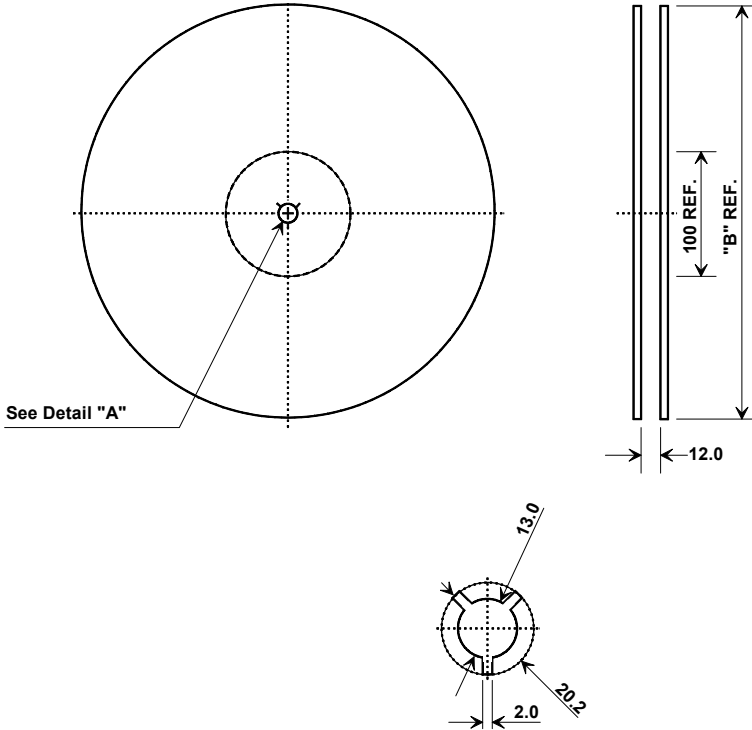

"B"		Quantity Per Reel
Inches	millimeters	
7	178	500
13	330	3000

COMPONENT ORIENTATION and DIMENSIONS

Carrier Tape Dimensions	
Ao	3.35 mm
Bo	3.35 mm
Ko	1.40 mm
Pitch	8.0 mm
W	12.0 mm

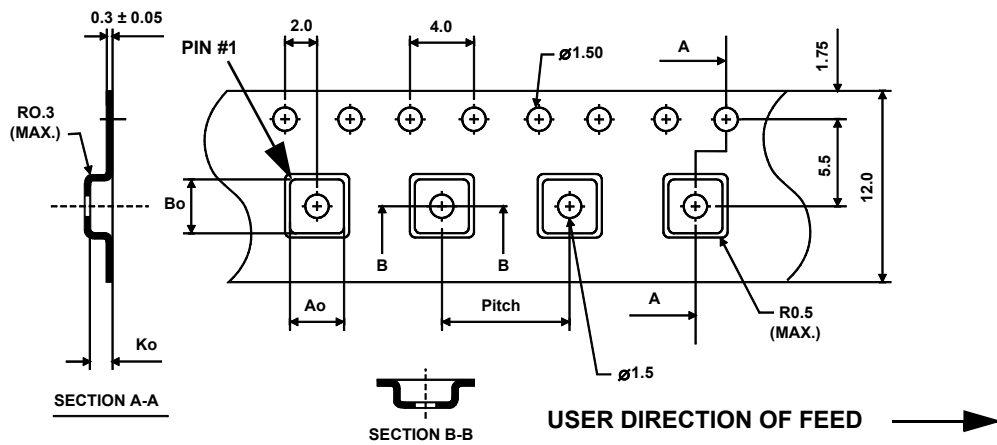

Recommended Reflow Profile

1. Preheating shall be fixed at 150~180°C for 60~90 seconds.
2. Ascending time to preheating temperature 150°C shall be 30 seconds min.
3. Heating shall be fixed at 220°C for 50~80 seconds and at 260°C +0/-5°C peak (10 seconds).
4. Time: 5 times maximum.

