

PART NO.	HOLE DIA. RANGE	PANEL THICKNESS	"A" REF
RRR-1	.188-.208 [4.76-5.28]	.059-.138 [1.5-3.5]	.14 [3.6]
RRR-2		.138-.217 [3.5-5.5]	.17 [4.4]

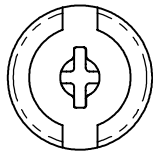

GROMMET

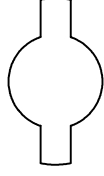

PIN

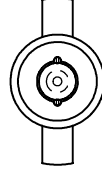
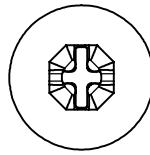
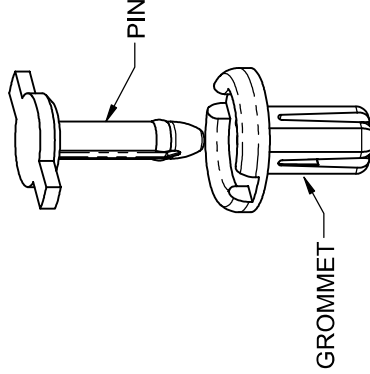
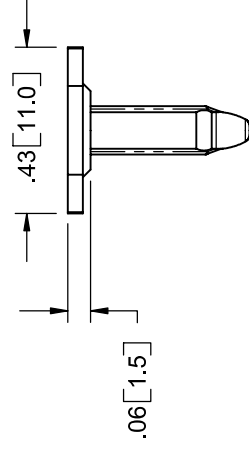
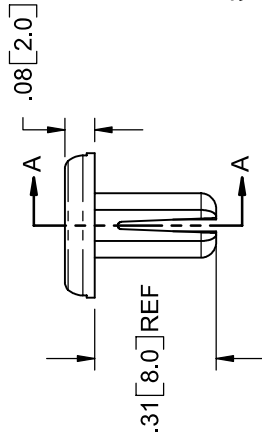

- NOTES:
 1. MATERIAL: NYLON 66/6 (RMS-103)
 2. COLOR: BLACK
 3. RIVET TO FIT IN INDICATED DIAMETER HOLE,
 OR .177 [4.5] MIN SQUARE HOLE
 4. PIN AND GROMMET ARE SUPPLIED UNASSEMBLED

TITLE: RICHCO REMOVABLE RIVET		DWG IN IN [MM]	FINAL	
FILE #: RRR-X	DWN: SK	APP: SK	PART #	
SHEET: 1 OF 1	SHEET SIZE: A	DT: 06/15/05	CHKD: DJZ	SEE TABLE PRINT TYPE CA
RE:	RICHCO, INC.	ENG@RICHCO-INC.COM (773) 539-4060		
CREATED USING SOLIDWORKS	TOLERANCES UNLESS NOTED .XX=±.010 .XXX=±.005 FRAC.=±1/64 ANG.=±1°			
B	SEE ECN # 1133 FOR CHANGES	S.J.	03/03/06	
A	RELEASED FOR PRODUCTION	SK	06/15/05	
REV.	DESCRIPTION	ENGR.	DATE	