

PRODUCT ADVISORY NOTICE

KEEPING YOU INFORMED OF PRODUCT CHANGES

To: All Customers, Sales Representatives and Distributors

Date: February 2, 2022

Subject: Optics Change for 61K, 61R, 63K and 63R Series High Resolution Optical Encoders

This Product Advisory Notice is to alert you that Grayhill is changing the optics used in 61K, 61R, 63K and 63R Series High Resolution Optical Encoders. ***Please forward this notification to the appropriate person(s) in your organization.***

Description of Change

61K, 61R, 63K and 63R Series High Resolution Optical Encoders optics are changing from the wire bonded ETIC ET6501B P/W/Q phototransistor and III-V TCD850 LED due to the fact that the ETIC components have gone obsolete. The optics used in these encoders will be replaced by the surface mounted Kingbright APH1608-LM33 phototransistor and Kingbright APH1608-LM32 LED. Other component changes in the design include the addition of a Fairchild NC7WZ17P6X buffer among other internal resistor and capacitor changes. The buffer was added due to replace the internal buffer that was integrated into the obsoleted ETIC phototransistor.

Reason for Change

Obsolesce mitigation due to end of life semiconductor used in encoder design.

Effective Date

Units produced on or after January 31, 2022 will have this design change implemented.

Actions Required

None. Please contact your Business Development Manager, if you have any questions.



PRODUCT ADVISORY NOTICE

KEEPING YOU INFORMED OF PRODUCT CHANGES

Part Numbers Affected

61K100	61KS128-060	61R128-075	61RS256-035	63K50	63KS50-120	63RS100-060
61K100-020	61KS25	61R128-080	61RS256-050	63K50-025	63KS64	63RS128-060
61K100-060	61KS256	61R128-150	61RS256-060	63K64	63R100	63RS25-060
61K128	61KS256-025	61R25	61RS32	63K64-050	63R100-050	63RS256
61K128-050	61KS256-040	61R256	61RS32-080	63KS100	63R128	63RS256-035
61K128-060	61KS256-060	61R256-020	61RS50	63KS100-020	63R128-020	63RS256-060
61K128-075	61KS256-250	61R256-030	61RS50-025	63KS100-040	63R128-080	63RS32
61K128-250	61KS32	61R256-035	61RS64	63KS100-100	63R25-060	63RS50
61K25	61KS32-040	61R256-100	61RS64-060	63KS100-250	63R25-120	63RS50-020
61K256	61KS32-060	61R32	63K100	63KS128	63R256	63RS64
61K256-060	61KS50	61R32-020	63K100-025	63KS128-040	63R256-020	63RS64-020
61K32	61KS50-060	61R50	63K100-050	63KS128-060	63R256-035	63RS64-180
61K50	61KS50-120	61R50-060	63K100-250	63KS128-180	63R256-050	
61K50-020	61KS64	61R64	63K128	63KS25	63R256-100	
61K50-060	61KS64-020	61R64-020	63K128-020	63KS25-060	63R32	
61K64	61KS64-030	61R64-050	63K128-040	63KS256	63R32-020	
61K64-040	61R100	61R64-060	63K128-050	63KS256-020	63R50	
61K64-050	61R100-020	61RS100	63K128-060	63KS256-025	63R50-020	
61K64-060	61R100-050	61RS100-020	63K25	63KS256-060	63R64	
61KS100	61R100-060	61RS128	63K256	63KS256-100	63R64-020	
61KS100-115	61R100-100	61RS128-040	63K256-050	63KS32	63R64-050	
61KS128	61R128	61RS128-080	63K256-060	63KS32-060	63R64-060	
61KS128-020	61R128-020	61RS25-060	63K256-240	63KS50	63RS100	
61KS128-035	61R128-050	61RS256	63K256-250	63KS50-025	63RS100-020	
61KS128-050	61R128-060	61RS256-020	63K32	63KS50-040	63RS100-035	



LREQ-SP02-2809

61K/61R/63K/63R ETIC Replacement
Quality Test Report

Revision A
January 28, 2022

TABLE OF CONTENTS

Table of Contents.....	2
Testing Flow Chart	3
Group I	4
Group II	21
Group III	24

Fully Assembled Samples for Qual. Test: 33

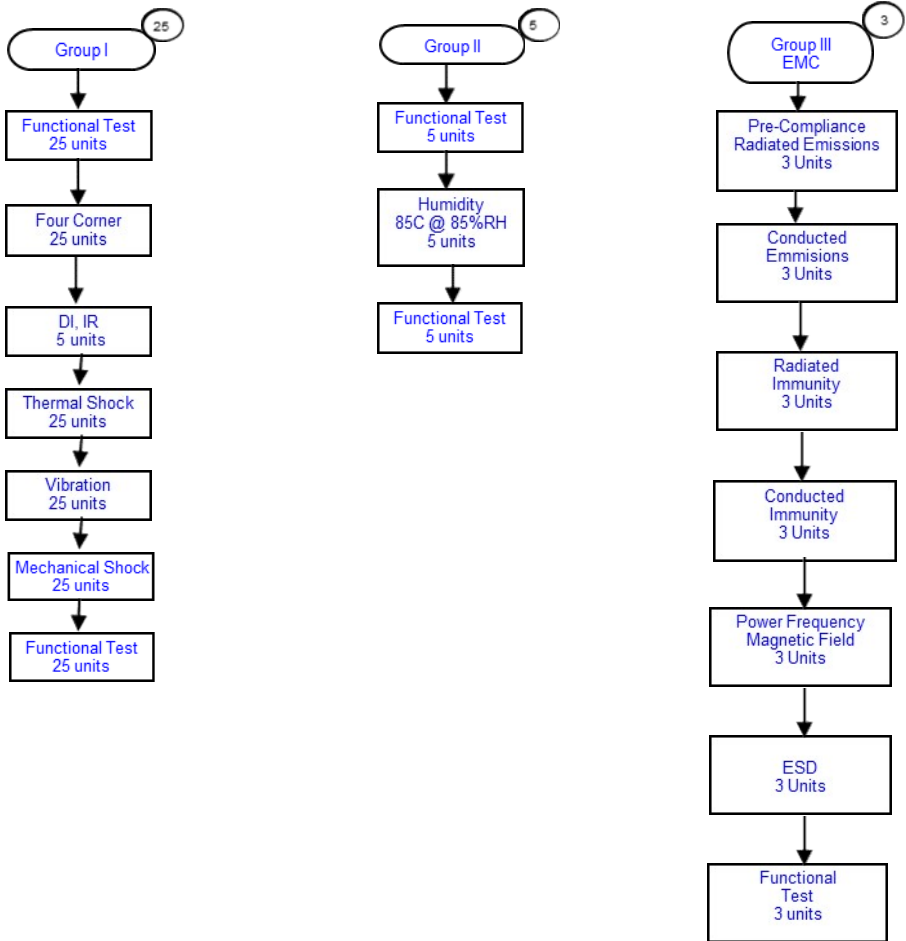

GROUP I

1.1. FOUR CORNERS

1.1.1. SUMMARY

DUT Serial Numbers	DUT Part Number	Test Location	Test Dates	Result
01 To 25	61K ETIC (61K256)	Grayhill, Inc.	October 25, 2021 To October 29, 2021	PASS

1.1.2. TEST SPECIFICATION

This test is to be run per 62 Series Optical Encoders DV Test Plan.

1.1.3. PURPOSE

This test is performed to ensure that the DUT operates at temperature and voltage extremes called out in the table below.

1.1.4. TEST CONDITIONS

Table 1 - Four Corners Test Conditions

Quantity	25
Duration (hr per corner)	8 Minimum
Minimum Voltage	4.75 V for 5V Encoder
Maximum Voltage	5.25 V for 5V Encoder
Operational Mode	Powered
Low Temperature (°C)	-40
High Temperature (°C)	+85
Mating Connector Attached	Yes

1.1.5. TEST PROCEDURE

1. Perform the Functional Test.
2. Place DUT in environmental chamber capable of high and low temperatures. Code output testing should be performed on DUT while still in temperature chamber after duration specified in Table 12. Encoder should be rotated through every detent position during code output testing. Encoder output voltages should be recorded for each channel in every detent position.
3. The code testing described above will be completed for four voltage/temperature extremes as follows:
 Minimum voltage/minimum temperature, for the duration specified below.
 Maximum voltage/maximum temperature, for the duration specified below.
 Minimum voltage/maximum temperature, for the duration specified below.
 Maximum voltage/minimum temperature, for the duration specified below.
4. Perform the full Functional Test after exposure.

1.1.6. TEST SETUP

Table 2 – Four Corners Equipment List

Equipment ID	Equipment Type	Model Number	Manufacturer	Last Calibrated Date	Calibration Due Date
GT-1002	Temperature Humidity Chamber	SM-8	Thermotron	July 06, 2021	July 06, 2022
GT-548	Thermometer Data logger	EasyView 15	EXTECH	May 18, 2021	May 18, 2022
GT-236	Digital Multimeter	87V	FLUKE	August 30, 2021	August 31, 2022
GT-2110	Digital Phosphor Oscilloscope	DPO2014B	Tektronix	June 09, 2021	June 30, 2022



Figure 1 – Four Corners Test Setup (DUTs in chamber)

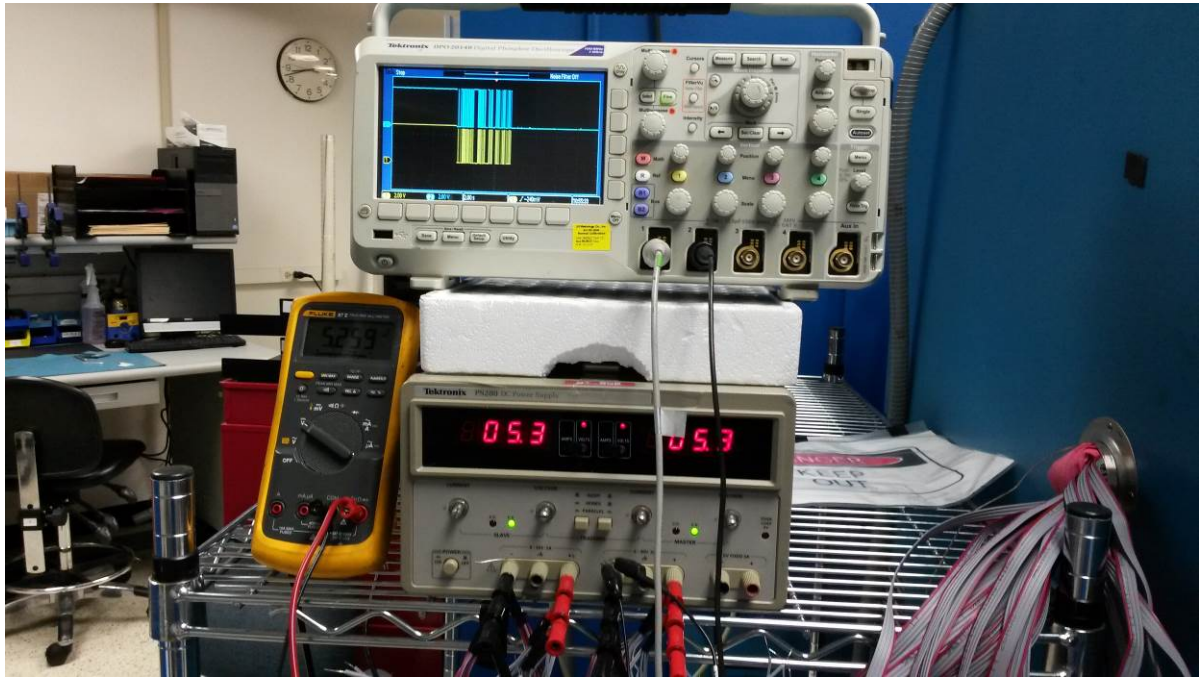

Figure 2 -- Four Corners Electrical Test Setup

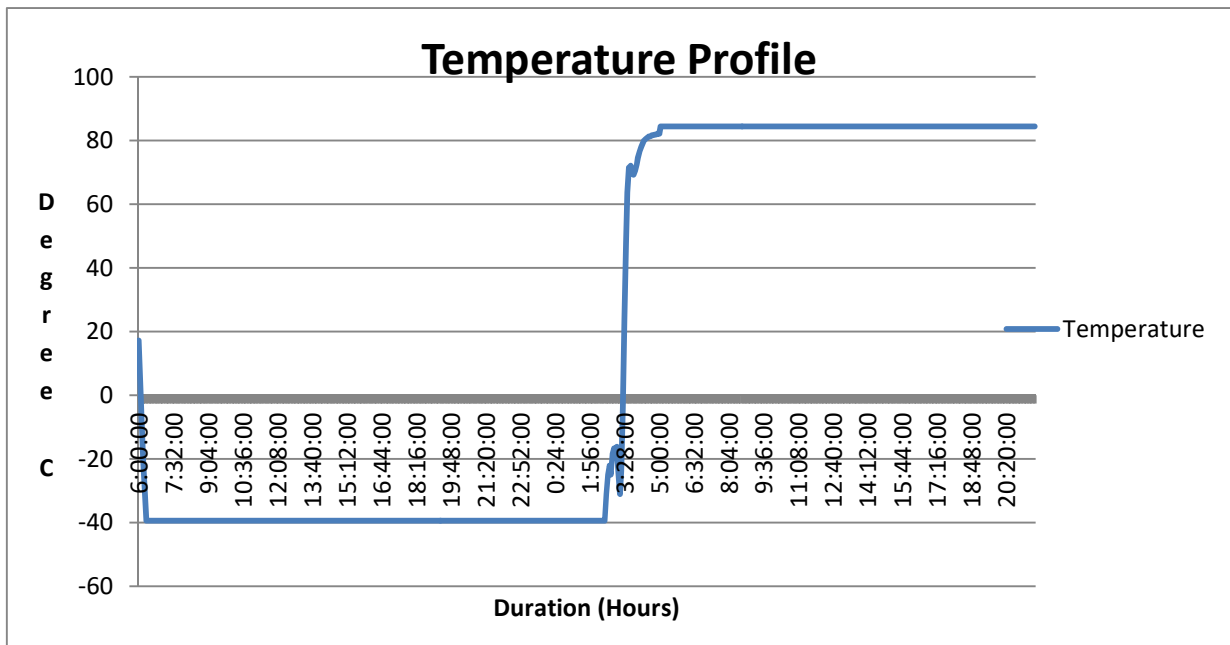

Figure 3 – Four Corners (Temperature Profile of Chamber)

1.1.7. COMPLIANCE CRITERIA

The DUT must be functionally tested and operate as intended during and after the test.

1.1.8. TEST RESULTS

DUT Serial Number	Test Dates	Result
01 To 25	October 25, 2021 To October 29, 2021	PASS

1.1.9. INSULATION RESISTANCE AND DIELECTRIC TEST DATA

DATA SHEET									
GRAYHILL		Laboratory Test Report No. SP02-2809				Page of _____ Pages			
Test : Insulation Resistance		Spec:		Para:		Date: 10/29/2021			
Limits of Requirements: Applied 100 Volts DC for 5 Seconds Shall be greater than 1000 MegOhms						Mfg. No:			
Prior Conditioning: Four Corners						Military No:			
Manufacturer: Grayhill, Inc.			Temp: 23.2°C		Hum.: 32.6%Rh		Tested By:		
Instruments: GT-279 Megohmmeter Cal Due Date 10/31/2021						Lab Manager Check:			
						Witnessed By:			
Unit of Measure: Giga Ohms									
Sample#	Terminals & Shaft								
1	4.1								
6	3.9								
11	4.3								
16	3.8								
21	3.7								

<u>DATA SHEET</u>									
GRAYHILL		Laboratory Test Report No. SP02-2809				Page of _____ Pages			
Test : Dielectric		Spec:		Para:		Date: 10/29/2021			
Limits of Requirements: Applied 500 Volts AC for 60 Seconds Leakage Current Shall be less than 100 microAmpere						Mfg. No:			
Prior Conditioning: Four Corners						Military No:			
Manufacturer: Grayhill, Inc.			Temp: 23.2°C		Hum.: 32.6%Rh		Tested By:		
Instruments: GT-63 Dielectric Withstand Tester Cal Due Date 04/30/2022						Lab Manager Check:			
Unit of Measure: Giga Ohms						Witnessed By:			
Sample#	Terminals & Shaft								
1	Pass								
6	Pass								
11	Pass								
16	Pass								
21	Pass								

1.1.10. TEST SUMMARY

Testing was completed per the test specification and test conditions stated. A BASIC Functionality Check was performed before testing began and again when all testing was completed.

1.2. THERMAL SHOCK

1.2.1. SUMMARY

DUT Serial Numbers	DUT Part Number	Test Location	Test Dates	Result
01 To 25	61K ETIC (61K256)	Grayhill, Inc.	October 29, 2021 To November 01, 2021	PASS

1.2.2. TEST SPECIFICATION

This test is to be run per 62 Series Optical Encoders DV Test Plan.

1.2.3. PURPOSE

This test is performed to verify that the DUT is free from manufacturing defects caused by thermally induced stresses, which could occur during intended useful life. This test is intended specifically for assessing thermal coefficient mismatch issues, particularly solder fatigue cracking. Typical environmental effects of this test are fatiguing of materials due to stress created by contraction and expansion of materials. Fatigue issues can occur in:

- solder
- solder connections
- PCB traces

1.2.4. TEST CONDITIONS

Table 3 – Thermal Shock Test Conditions

Quantity	25
Duration (Cycles)	25
Operational Mode	Unpowered
Minimum Temperature (°C)	-40
Maximum Temperature (°C)	85
Dwell Time (Hour)	1
Mating Connector Attached	No

1.2.5. TEST PROCEDURE

1. Visual Inspection of the DUT is to be performed before and after testing.
2. Perform the Functional Test.
3. Place the DUT in the chamber.
4. Power up the chamber and let it stabilize at the specified temperatures.
5. Continue to cycle the DUT according to the test condition table.
6. When the total number of cycles are complete, return the DUT to ambient conditions.
7. Perform the Functional Test.

1.2.6. TEST SETUP

Table 4 – Thermal Shock Equipment List

Equipment ID	Equipment Type	Model Number	Manufacturer	Last Calibrated Date	Calibration Due Date
GT-1008	Thermal Shock Chamber	VTS-3-6-6-SC/WC	Cincinnati Sub	October 29, 2021	October 29, 2022
GT-543	Thermometer	52II	FLUKE	October 2021	October 2022
GT-236	Digital Multimeter	87V	FLUKE	August 30, 2021	August 31, 2022
GT-162	DC Power Supply	E3649A	Agilent	Verified at Use	Verified at Use
GT-2110	Digital Phosphor Oscilloscope	DPO2014B	Tektronix	June 09, 2021	June 30, 2022



Figure 4 – Thermal Shock Test Setup (DUTs in chamber)

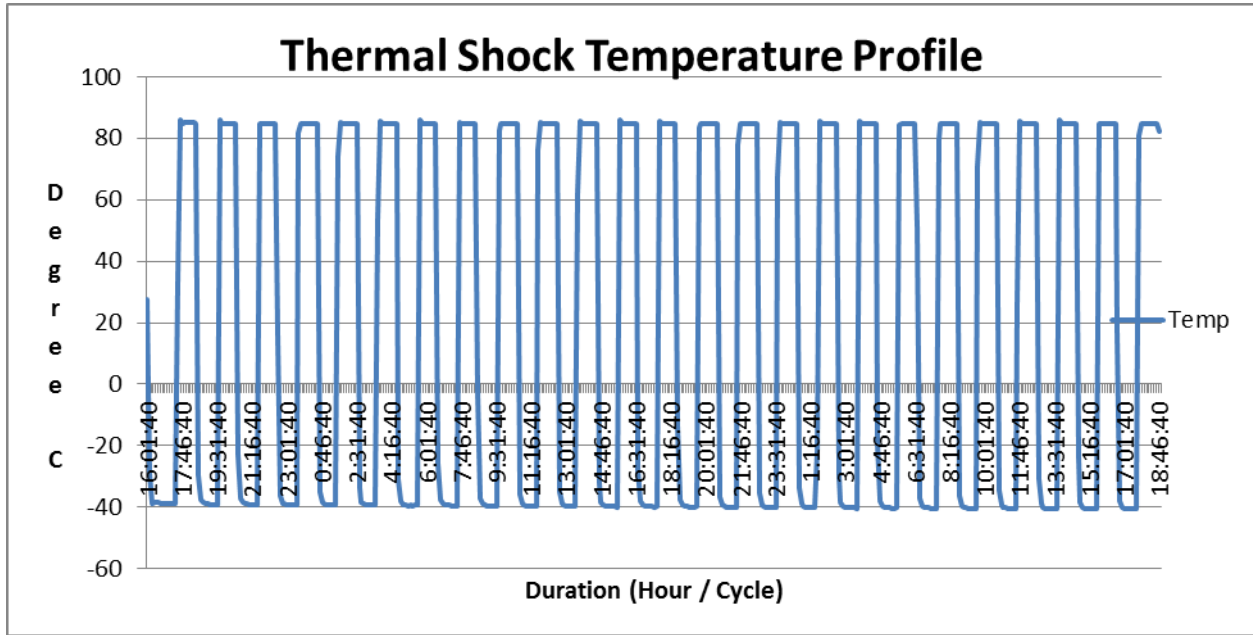

Figure 5 – Thermal Shock (Temperature Profile of Chamber)

1.2.7. COMPLIANCE CRITERIA

The DUT must have no part breakage and no disassembly of parts. The DUT must be functionally tested and operate as intended after test

1.2.8. TEST RESULTS

DUT Serial Number	Test Dates	Result
01 To 25	October 29, 2021 To November 01, 2021	PASS

1.2.9. TEST SUMMARY

Testing was completed per the test specification and test conditions stated. A BASIC Functionality Check was performed before testing began and again when all testing was completed.

1.3. VIBRATION (SINUSOIDAL)

1.3.1. SUMMARY

DUT Serial Numbers	DUT Part Number	Test Location	Test Dates	Result
01 To 25	61K ETIC (61K256)	Grayhill, Inc.	November 03, 2021 To November 05, 2021	PASS

1.3.2. TEST SPECIFICATION

This test is to be run per 62 Series Optical Encoders DV Test Plan.

1.3.3. PURPOSE

The purpose of this test is to evaluate the product design in terms of its ability to withstand vibration. The potential product failure modes and effects detected in this test are:

- cracked housing/components
- broken product/components
- open solder joints
- dislodged parts

1.3.4. TEST CONDITIONS

Table 5 - Vibration Test Conditions

Quantity	25
Test Duration per Axis (Hours)	4
Applicable Axes	X, Y, Z
Operational Mode	Powered
Temperature (°C)	23.5
Acceleration Level (G)	15G Peak
Lower Limit Frequency	10Hz
Upper Limit Frequency	2000Hz
Mating Connector Attached	Yes

1.3.5. TEST PROCEDURE

1. Visual Inspection of the unit is to be performed before and after testing.
2. Perform the Functional Test.
3. Attach test products in specified orientation.
4. Attach connectors and tie down wire harnesses at appropriate lengths, if required.
5. Apply vibration, temperature, and voltage per specified levels and verify operation, if required.
6. Test products per parameters in Table 2 – Vibration Test Conditions.
7. Perform the Functional Test after exposure.

1.3.6. TEST SETUP

Table 6 – Vibration Equipment List

Equipment ID	Equipment Type	Model Number	Manufacturer	Last Calibrated Date	Calibration Due Date
GT-355	Vibration Controller	DVC-8	Vibration World	July 08, 2021	July 08, 2022
GT-535	Accelerometer	JTLD352C04/ACS-23	PCB	November 19, 2020	November 19, 2022
GT-353	Shaker Table	US-11VH/17-50	Dynamic Solutions	Not Required	Not Required
GT-354	Shaker Amp	SA-30	Dynamic Solutions	Not Required	Not Required
PWR-SUP-21	DC Power Supply	E3649A	Agilent	Verified at Use	Verified at Use
GT-236	Digital Multimeter	87V	FLUKE	August 30, 2021	August 31, 2022
GT-143	Hygrometer	MDM25	Michel	November 08, 2021	November 30, 2022
GT-2110	Digital Phosphor Oscilloscope	DPO2014B	Tektronix	June 09, 2021	June 30, 2022

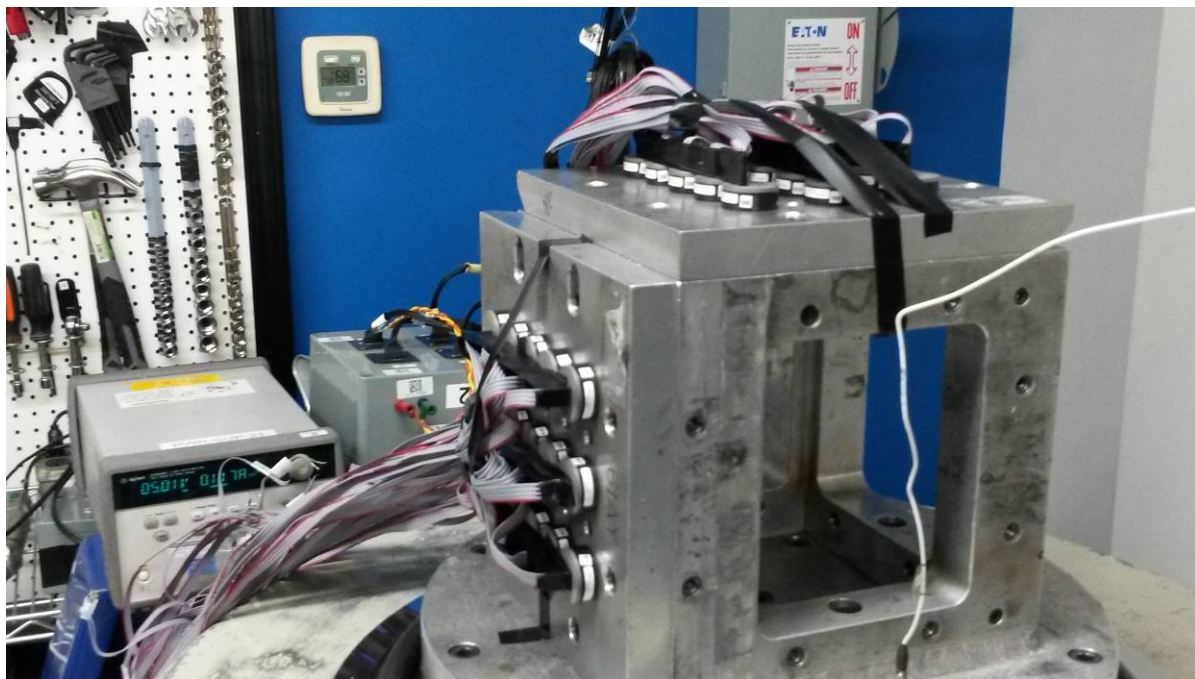

Figure 6 – Vibration Test Setup

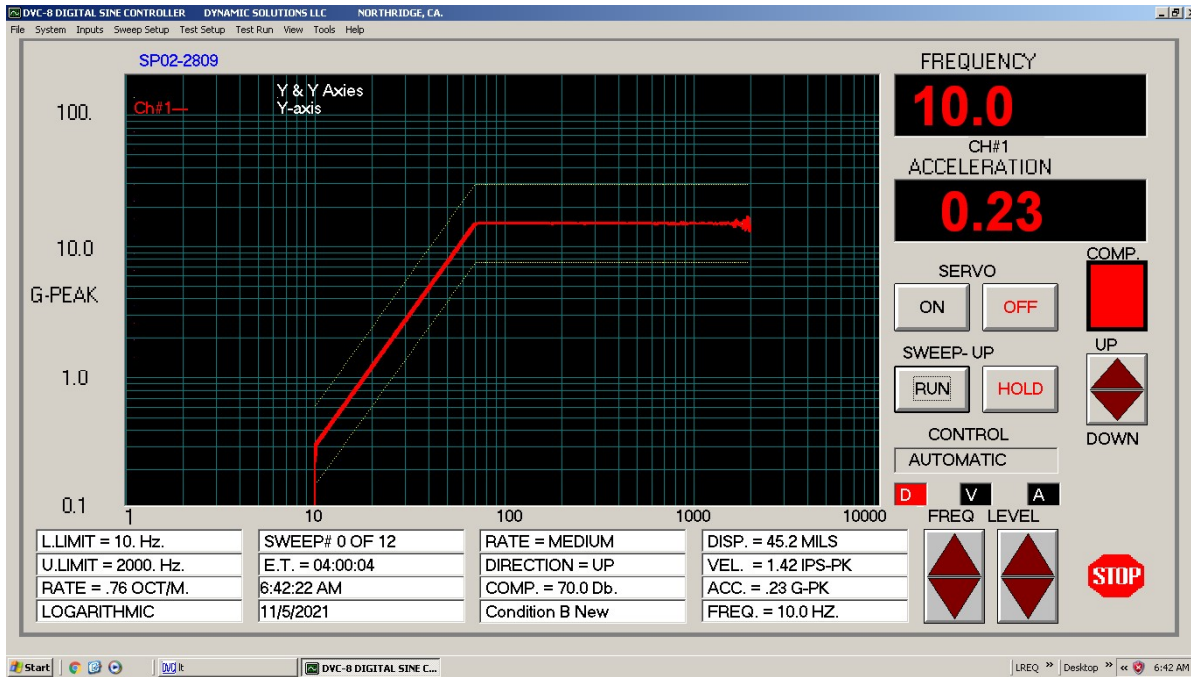

Figure 7 – Vibration Test Profile

1.3.7. COMPLIANCE CRITERIA

The DUT must be functionally tested and operate as intended during and after the test.

1.3.8. TEST RESULTS

DUT Serial Number	Visual	Output Code
1	PASS	PASS
2	PASS	PASS
3	PASS	PASS
4	PASS	PASS
5	PASS	PASS
6	PASS	PASS
7	PASS	PASS
8	PASS	PASS
9	PASS	PASS
10	PASS	PASS
11	PASS	PASS
12	PASS	PASS
13	PASS	PASS
14	PASS	PASS
15	PASS	PASS
16	PASS	PASS
17	PASS	PASS
18	PASS	PASS

19	PASS	PASS
20	PASS	PASS
21	PASS	PASS
22	PASS	PASS
23	PASS	PASS
24	PASS	PASS
25	PASS	PASS

1.3.9. TEST SUMMARY

Testing was completed per the test specification and test conditions stated. A BASIC Functionality Check was performed before testing began and again when all testing was completed.

1.4. MECHANICAL SHOCK

1.4.1. SUMMARY

DUT Serial Numbers	DUT Part Number	Test Location	Test Dates	Result
01 to 25	61K ETIC (61K256)	Grayhill, Inc.	November 10, 2021 To November 12, 2021	PASS

1.4.2. TEST SPECIFICATION

This test is to be run per 62 Series Optical Encoders DV Test Plan.

1.4.3. PURPOSE

The purpose of this test is to validate the manufacturing process in its ability to produce a product capable of withstanding the effects of shipping, handling, installation, and operational shock. The potential product issue modes and effects detected in this test are:

- housing cracks
- product/component breakage
- inadvertent activation

1.4.4. TEST CONDITIONS

Table 7 – Mechanical Shock (Test 1 - Condition C) Test Conditions

Quantity	25
Operational Mode	Powered
Temperature (°C)	22.6
Humidity (%Rh)	34
Pulse Type	Half Sine
Acceleration (G)	100
Pulse duration (MilliSec)	6
Direction	3 in each of +/-X, +/-Y, +/-Z (18 shocks total)
Mating Connector Attached	Yes

Table 8 – Mechanical Shock (Test 2 - Condition I) Test Conditions

Quantity	25
Operational Mode	Powered
Temperature (°C)	22.6
Humidity (%Rh)	34
Pulse Type	Sawtooth
Acceleration (G)	100
Pulse duration (MilliSec)	6
Direction	3 in each of +/-X, +/-Y, +/-Z (18 shocks total)
Mating Connector Attached	Yes

1.4.5. TEST PROCEDURE

1. Verify specified Test Conditions Table with test fixture on test table.
2. Perform the Functional Test.
3. Place product in a mounting fixture in specified orientation.
4. Power up DUT.
5. Test product for specified shocks/axis.
6. Repeat until all modules have completed their total shocks/unit
7. Perform the Functional Test after exposure.

1.4.6. TEST SETUP

Table 9 – Mechanical Shock Equipment List

Equipment ID	Equipment Type	Model Number	Manufacturer	Last Calibrated Date	Calibration Due Date
GT-356	VST Pneumatic	PSM500	VST	Verify at Use	Verify at Use
GT-533	Accelerometer	JTLD352C04	PCB	10/2021	10/2022
NA	Mechanical Shock Application	V1.3.7A USB W/Logger	Vibration & Shock Technologies	Not Required	Not Required
NA	DC Power Supply	HY3005F-3	Mastertech	Verified at Use	Verified at Use
GT-236	Digital Multimeter	87V	FLUKE	August 30, 2021	August 31, 2022
GT-143	Hygrometer	MDM25	Michel	November 08, 2021	November 30, 2022
GT-2110	Digital Phosphor Oscilloscope	DPO2014B	Tektronix	June 09, 2021	June 30, 2022

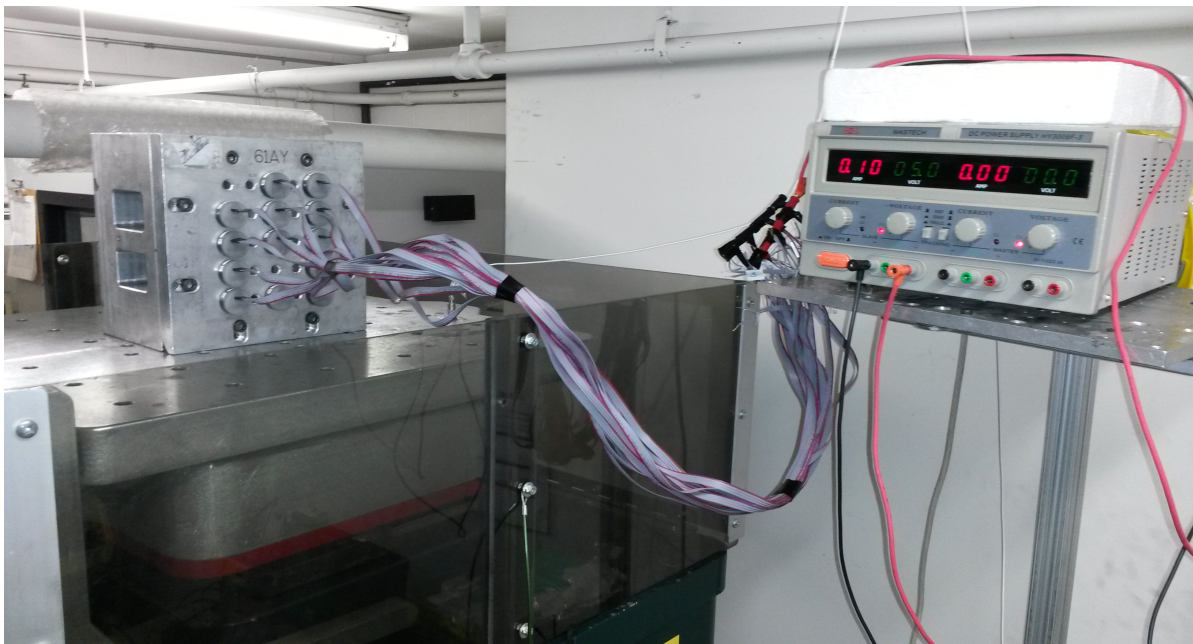

Figure 8 – Mechanical Shock Test Setup

Grayhill

VST Shock Tool Data File
Wed 11-10-21 @ 13:30:54
Sample rate(Hz): 100000
plot scale assign
Sensor Sensitivities (mV/UNIT) 9.6600
Data (Volts)

Tolerance Bands Tol
Settings Tol
Peak (G's) 100.0
Duration (ms) 6.0

Current Time 13:33:48
11/10/2021

Notes

Selected Plot 1

Peak (g)	108.607
Delta T (ms)	6.236
Delta V (In/s)	152.6
1/2Delta T (Hz)	80.2
LP Filter (Hz)	2.0k

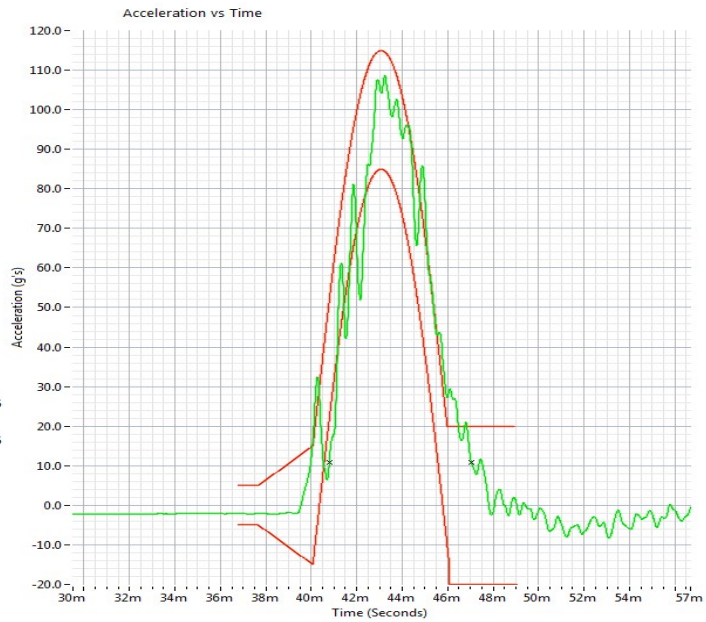

Figure 9 – 100G – 6msec-Half Sine Test Profile

Grayhill

VST Shock Tool Data File
Fri 11-12-21 @ 08:55:04
Sample rate(Hz): 100000
plot scale assign
Sensor Sensitivities (mV/UNIT) 9.6600
Data (Volts)

Tolerance Bands Tol
Settings Tol
Peak (G's) 100.0
Duration (ms) 6.0

Current Time 08:55:19
11/12/2021

Notes

Selected Plot 1

Peak (g)	101.967
Delta T (ms)	5.896
Delta V (In/s)	146.6
1/2Delta T (Hz)	84.8
LP Filter (Hz)	2.0k

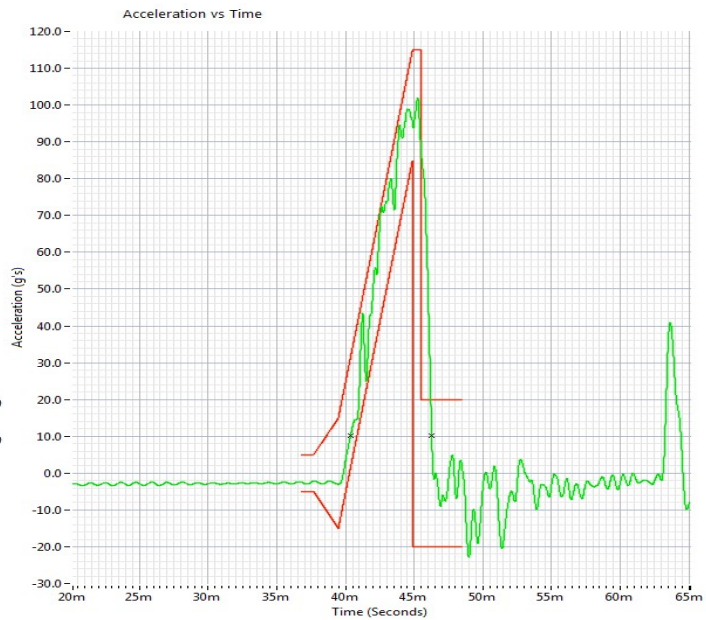

Figure 10 - 100G – 6msec-Sawtooth Test Profile

1.4.7. COMPLIANCE CRITERIA

DUT must have no disassembly of parts. The DUT must be functionally tested and operate as intended after test.

1.4.8. TEST RESULTS

2.0	DUT SERIAL NUMBER	Visual	Output Code
	1	PASS	PASS
	2	PASS	PASS
	3	PASS	PASS
	4	PASS	PASS
	5	PASS	PASS
	6	PASS	PASS
	7	PASS	PASS
	8	PASS	PASS
	9	PASS	PASS
	10	PASS	PASS
	11	PASS	PASS
	12	PASS	PASS
	13	PASS	PASS
	14	PASS	PASS
	15	PASS	PASS
	16	PASS	PASS
	17	PASS	PASS
	18	PASS	PASS
	19	PASS	PASS
	20	PASS	PASS
	21	PASS	PASS
	22	PASS	PASS
	23	PASS	PASS
	24	PASS	PASS
	25	PASS	PASS

Testing was completed per the test specification and test conditions stated. A BASIC Functionality Check was performed before testing began and again when all testing was completed.

GROUP II

2.1. 85 / 85 HUMIDITY

2.1.1. SUMMARY

DUT Serial Numbers	DUT Part Number	Test Location	Test Dates	Result
26 To 30	61K ETIC (61K256)	Grayhill, Inc.	October 21, 2021 To November 12, 2021	Pass

2.1.2. TEST SPECIFICATION

This test is to be run per 62 Series Optical Encoders DV Test Plan.

2.1.3. PURPOSE

This test is performed to ensure that the development of dendrites, which can induce product failure over a specified period time due to constant Temperature Humidity Bias (THB), does not occur.

Constant THB is the preferred method for assessing the potential for failure due to exposure to ambient moisture.

2.1.4. TEST CONDITIONS

Table 10 – 85/85 Humidity Test Conditions

Quantity	5
Duration (Hours)	500
Operational Mode	Powered
Maximum Temperature (°C)	85
Humidity Level (%Rh)	85
Mating Connector Attached	Yes

2.1.5. TEST PROCEDURE

1. Visual Inspection of the unit is to be performed before and after testing.
2. Perform the Functional Test.
3. Place DUT in the chamber.
4. Power up the chamber and let it stabilize at the specified temperature/humidity.
5. When the set duration is complete, return the DUT to ambient conditions.
6. Perform the Functional Test after exposure.

2.1.6. TEST SETUP

Table 11 – 85/85 Humidity Test Equipment List

Equipment ID	Equipment Type	Model Number	Manufacturer	Last Calibrated Date	Calibration Due Date
GT-1012	Temperature Humidity Chamber	SM16-8200	Thermotron	September 29, 2021	September 29, 2022

GT-548	Thermometer / Data Logger	EasyView 15	EXTECH	May 18, 2021	May 18, 2022
GT-554	DC Power Supply	GPS-4251	Gw Instek	Verified at Use	Verified at Use
GT-236	Digital Multimeter	87V	FLUKE	August 30, 2021	August 31, 2022
PAL-2	Oscilloscope – 1GHz Mixed Signal	MSO7104B	Agilent	December 22, 2020	December 31, 2021

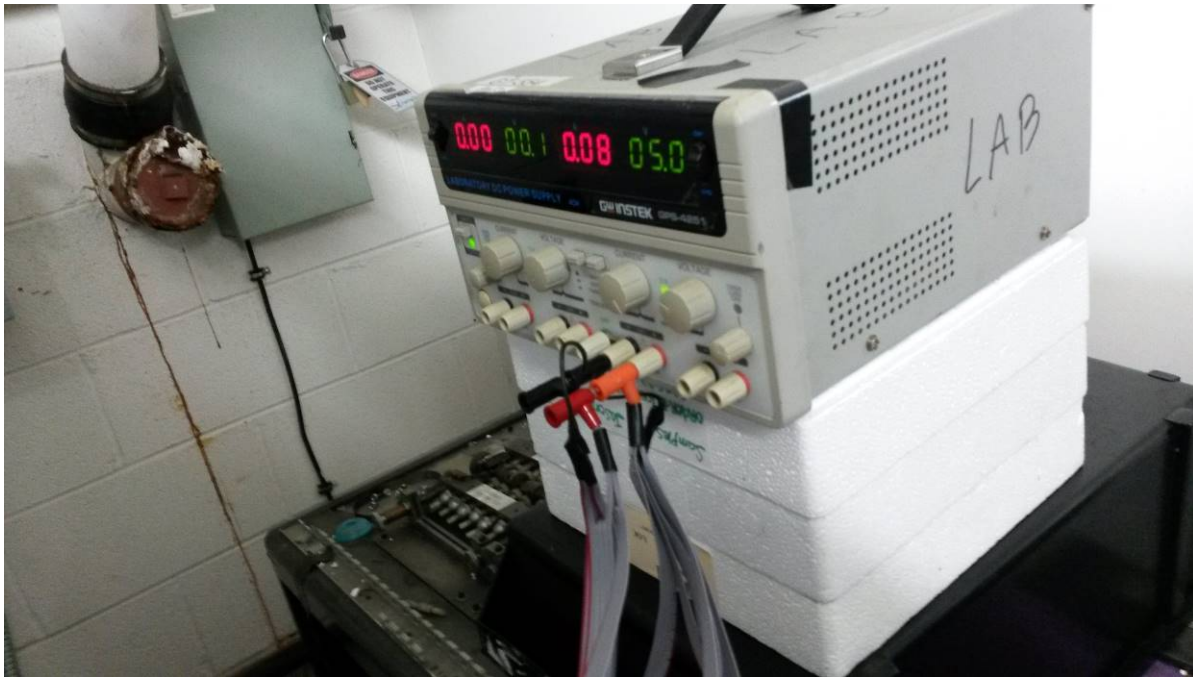

Figure 1 – 85/85 Humidity Electrical Test Setup

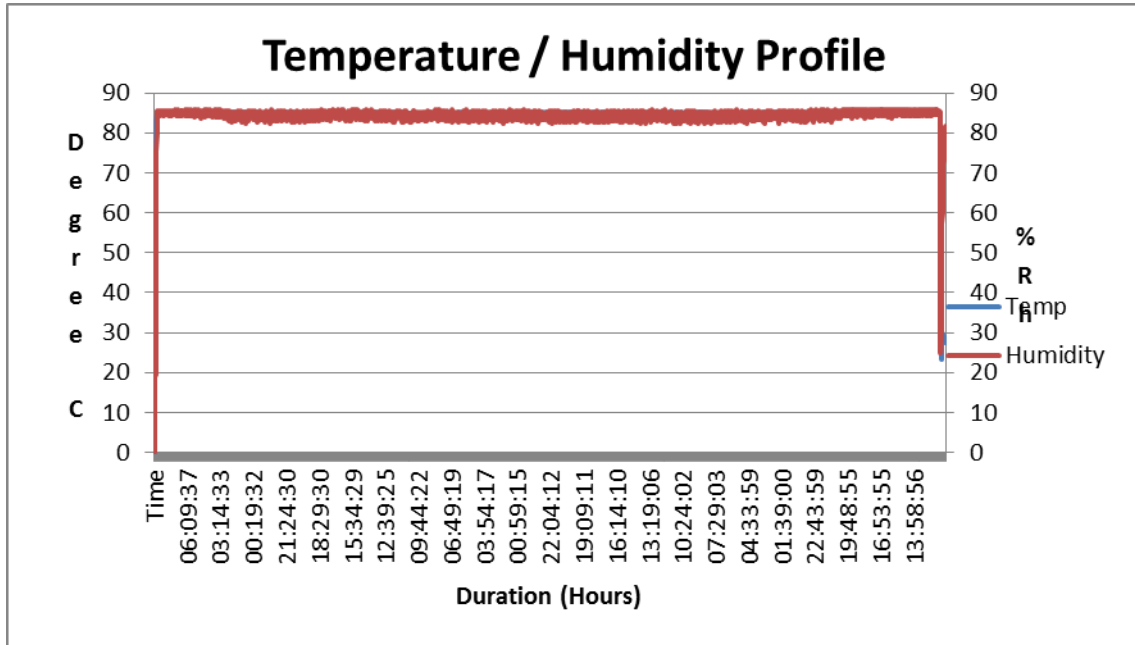

Figure 2 – 85/85 Humidity & Temperature Profile of Chamber

2.1.7. COMPLIANCE CRITERIA

The DUT must be functionally tested and show no evidence of dendritic growth after test. The DUT must have no epoxy cracking, no rubber breakage, and no disassembly of parts.

2.1.8. TEST RESULTS

DUT Serial Number	Visual	Output Code
26	PASS	PASS
27	PASS	PASS
28	PASS	PASS
29	PASS	PASS
30	PASS	PASS

2.1.9. TEST SUMMARY

Testing was completed per the test specification and test conditions stated. A BASIC Functionality Check was performed before testing began and again when all testing was completed.

GROUP III

3.1 RADIATED EMISSIONS

3.1.1 SUMMARY

DUT Serial Numbers	DUT Part Number	Test Location	Test Dates	Result
41-42-43	61K ETIC (61K256)	Grayhill, Inc.	November 15, 2021	PASS

3.1.2 TEST SPECIFICATION

This test is to be run per 62 Series, Section 11 (EMC Tests) Optical Encoders DV Test Plan, ANSI C63.4, and BS EN 55011.

3.1.3 PURPOSE

The purpose of this test is to measure the emissions characteristics of the EUT. This measurement will be performed over the frequency range of 30 MHz to 1000 MHz at a distance specified in the setup portion of ANSI C63.4. The DUT shall have its emissions characteristics measured for compliance. Emissions shall be within tolerance as given in the Compliance Criteria.

3.1.4 TEST CONDITIONS

Table 12 – Radiated Emissions Test Conditions

Quantity	3
Temperature (°C)	23.4
Humidity (%Rh)	32.6
Atmospheric Pressure (mB)	1019.8
Frequency Range (MHz)	30-1000
Bandwidth (kHz)	100
**Test Limits (Quasi-peak Limits)	
Frequency Range 30 To 230 MHz	**40dB(μV/m)
Frequency Range 230 To 1000 MHz	**47dB(μV/m)
Operational Mode	Powered
Voltage Apply (DC)	5
Performance Criteria	Class B

**Test limits for 3 meters chamber only.

3.1.5 TEST PROCEDURE

A computer-controlled analyzer was used to perform the Radiated Emissions measurements. Frequencies ranged from 30MHz to 1,000MHz. The computer recorded the peak of each sub-range. The data was then printed from the computer.

Reference the Quality Standards Manual Test Lab Procedure (QSM-TLP), for details on setting up and running the Radiated Emissions Test.

Perform the test per BS EN 55011 with the following additions/changes.

- Perform a BASIC Functionality check before testing has begun
- Perform a BASIC Functionality check after all testing has completed.

- Testing is to be setup per the electrical setup diagram as shown in “ELECTRICAL SETUP FORM”
- Performance criteria shall be determined by comparing the Frequency Range and Voltage Level from the Test Conditions (**Error! Reference source not found.**) to BS EN 55011:2009, section 6.3.2.
- Use the values from the Test Conditions section (3.1.4) for all relevant conditions.

3.1.6 TEST SETUP

Table 13 – Radiated Emissions Equipment List

Equipment ID	Equipment Type	Model Number	Manufacturer	Last Calibrated Date	Calibration Due Date
GT-328	Spectrum Analyzer	8594EM	Hewlett Packard	February 1, 2020	March 1, 2022
GT-329	Signal Generator	8648B	Hewlett Packard	February 1, 2020	March 1, 2022
GT-326	Bilog Antenna	CBL6140A	Schaffner	February 1, 2020	March 1, 2022
N/A	115Vac To 5VDC Converter	24MS	Sola Electric	Verified at Use	Verified at Use
GT-236	True RMS Multimeter	87V	FLUKE	August 30, 2021	August 30, 2022
GT-143	Hygrometer	MDM25	Michel	November 08, 2021	November 30, 2022



Figure 11 – Radiated Emissions Test Setup

3.1.7 COMPLIANCE CRITERIA

The DUT shall pass the BASIC Functionality checks.

The DUT shall meet the Performance Criteria stated in the Test Conditions (1.1.4). Performance Criteria specifications can be found in BS EN 55011:2009, section 6.2.2.3.

While testing is performed to and will be analyzed to the specification, the testing is to be conducted for engineering informational, pre-compliance purposes only.

3.1.8 TEST RESULTS

Table 14 - Results for Radiated Emissions

DUT No. 41	November 15, 2021	Pass
DUT No. 42	November 15, 2021	Pass
DUT No. 43	November 15, 2021	Pass

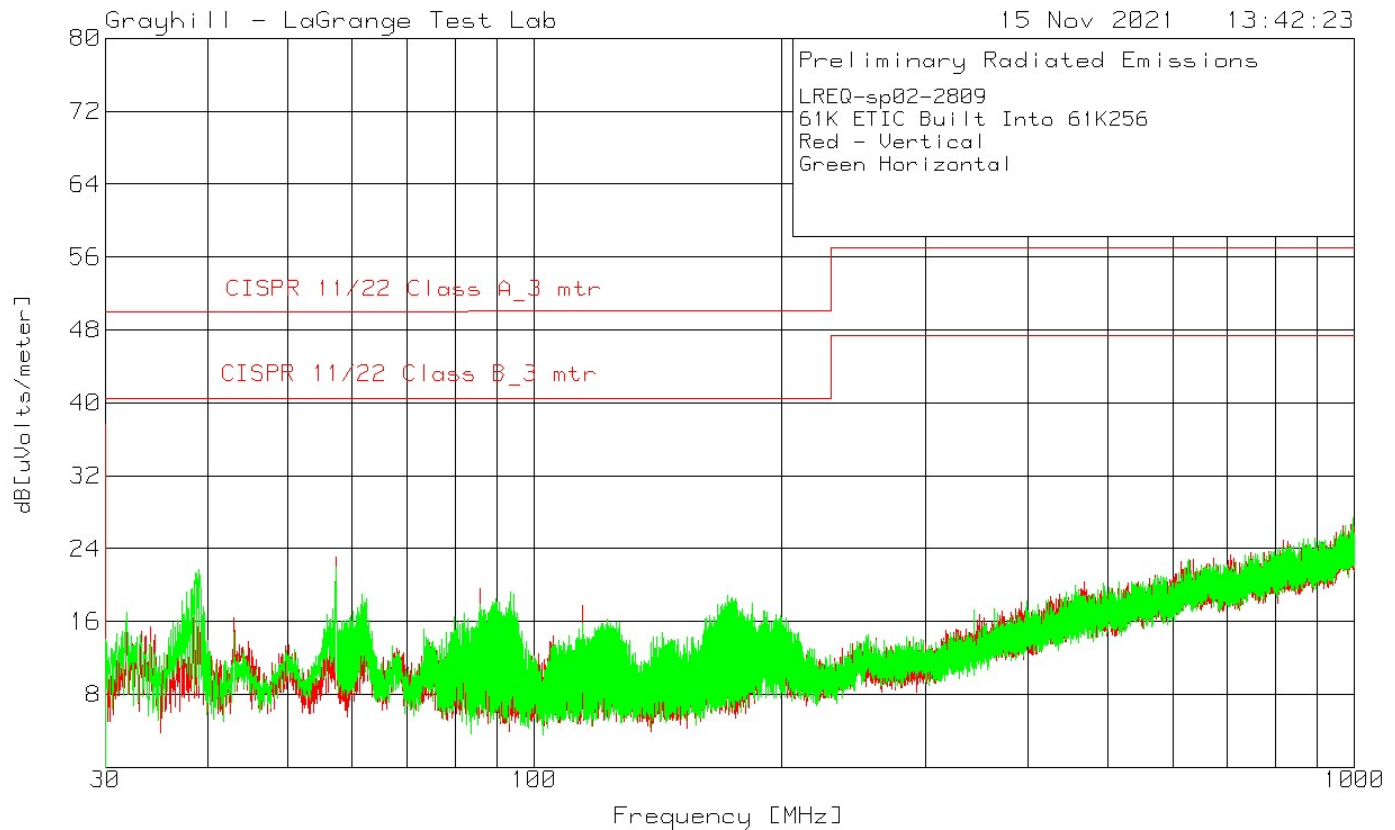

Figure 12 – Radiated Emissions Graph (Test Limits)

3.1.9 TEST SUMMARY

After completion of the test, DUTs passed the BASIC Functionality checks and met the stated Performance Criteria.

3.2 CONDUCTED EMISSIONS

3.2.1 SUMMARY

DUT Serial Numbers	DUT Part Number	Test Location	Test Dates	Result
41-42-43	61K ETIC (61K256)	Grayhill, Inc.	November 17, 2021	PASS

3.2.2 TEST SPECIFICATION

This test is to be run per 62 Series, Section 11 (EMC Tests) Optical Encoders DV Test Plan and EN 55022.

3.2.3 PURPOSE

The purpose of this test is to measure the conducted emissions characteristics of the EUT from the AC/DC input of the DUT. This measurement will be performed over the frequency range of 150 kHz to 30 MHz. Measurements shall be repeated on both leads within the power cord

3.2.4 TEST CONDITIONS

Table 15 – Conducted Emissions Test Conditions

Quantity	3
Temperature (°C)	23.4
Humidity (%Rh)	32.6
Atmospheric Pressure (mB)	1019.8
Frequency Range (Hz)	150 kHz To 30MHz
Operational Mode	Powered & Monitored
Voltage Apply (DC)	5
Performance Criteria	Class B

3.2.5 TEST PROCEDURE

A computer-controlled analyzer was used to perform the conducted emissions measurements. Frequencies ranged from 150 kHz to 30 MHz. The computer recorded the peak of each sub-range. The data was then printed from the computer.

Measurements were repeated on both leads within the input power wires. If the DUT input power wires exceeded 80 cm in length, the excess length of the input wires was made into a 30 to 40 cm bundle near the center of the wires. The LISN was placed on the floor at the base of the test platform and electrically bonded to the ground plane.

Reference the Quality Standards Manual Test Lab Procedure (QSM-TLP), for details on setting up and running the Conducted Emissions test.

Perform the test per BS EN 55022 with the following additions/changes.

- Perform a BASIC Functionality check before testing has begun
- Perform a BASIC Functionality check after all testing has completed.
- Testing is to be setup per the electrical setup diagram as shown in “ELECTRICAL SETUP FORM”

- Performance criteria shall be determined by comparing the Frequency Range and Voltage Level from the Test Conditions (**Error! Reference source not found.**) to EN 55022.
- Use the values from the Test Conditions section (3.1.4) for all relevant conditions.

3.2.6 TEST SETUP

Table 16 – Conducted Emissions Equipment List

Equipment ID	Equipment Type	Model Number	Manufacturer	Last Calibrated Date	Calibration Due Date
GT-328	Spectrum Analyzer	8594EM	Hewlett Packard	February 1, 2020	March 1, 2022
GT-329	Signal Generator	8648B	Hewlett Packard	February 1, 2020	March 1, 2022
GT-338	Transient Limiter	EM-7600	Electro-Metrics	March 09, 2020	March 31, 2022
GT-330	LISN	9252-50-R-24-BNC	Solar Electronics	March 09, 2020	March 31, 2022
NA	DC Power Supply	HY3005F-3	Dr. Meter	Calibrate at use	Calibrate at use
GT-236	True RMS Multimeter	87V	FLUKE	August 30, 2021	August 30, 2022
GT-603	True RMS Multimeter	179	FLUKE	April 06, 2021	April 30, 2022
GT-143	Hygrometer	MDM25	Michel	November 08, 2021	November 30, 2022

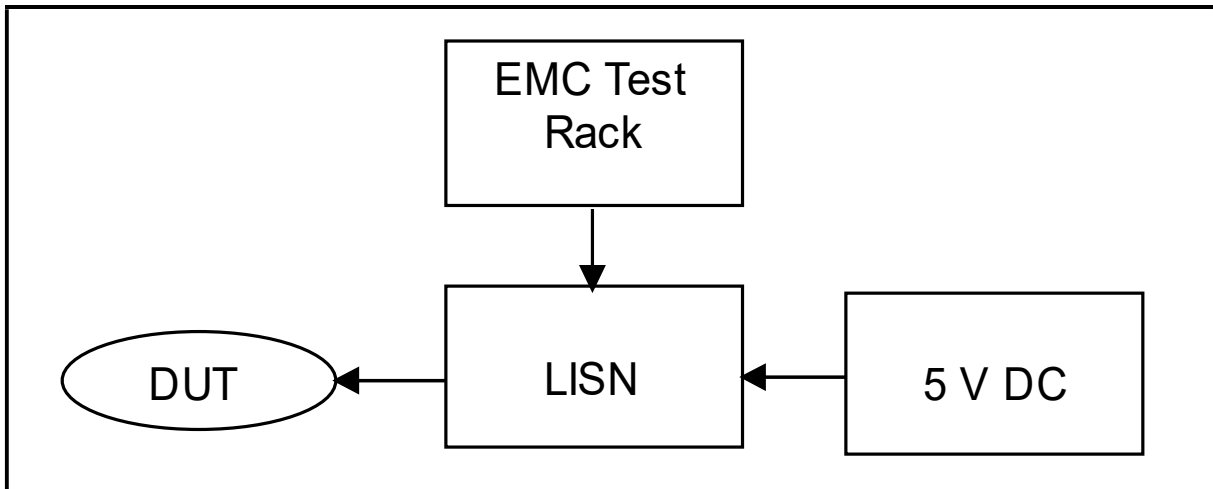

Figure 13 – Setup Configuration



Figure 14 – Conducted Emissions Test Setup

3.2.7 COMPLIANCE CRITERIA

The DUT shall pass the BASIC Functionality checks. Conducted emissions levels must be below levels listed in the class B table of EN 55022, Class B (See table 3 below).

Table 17 – Conducted Emissions Levels

Frequency (MHz)	Limits dB(μV)	
	Quasi-peak	Average
0.15 to 0.50	66 to 56	56 to 46
.50 to 5	56	46
5 to 30	60	50

3.2.8 TEST RESULTS

Table 18 - Results for Conducted Emissions

DUT No. 41	November 17, 2021	Pass
DUT No. 42	November 17, 2021	Pass
DUT No. 43	November 17, 2021	Pass

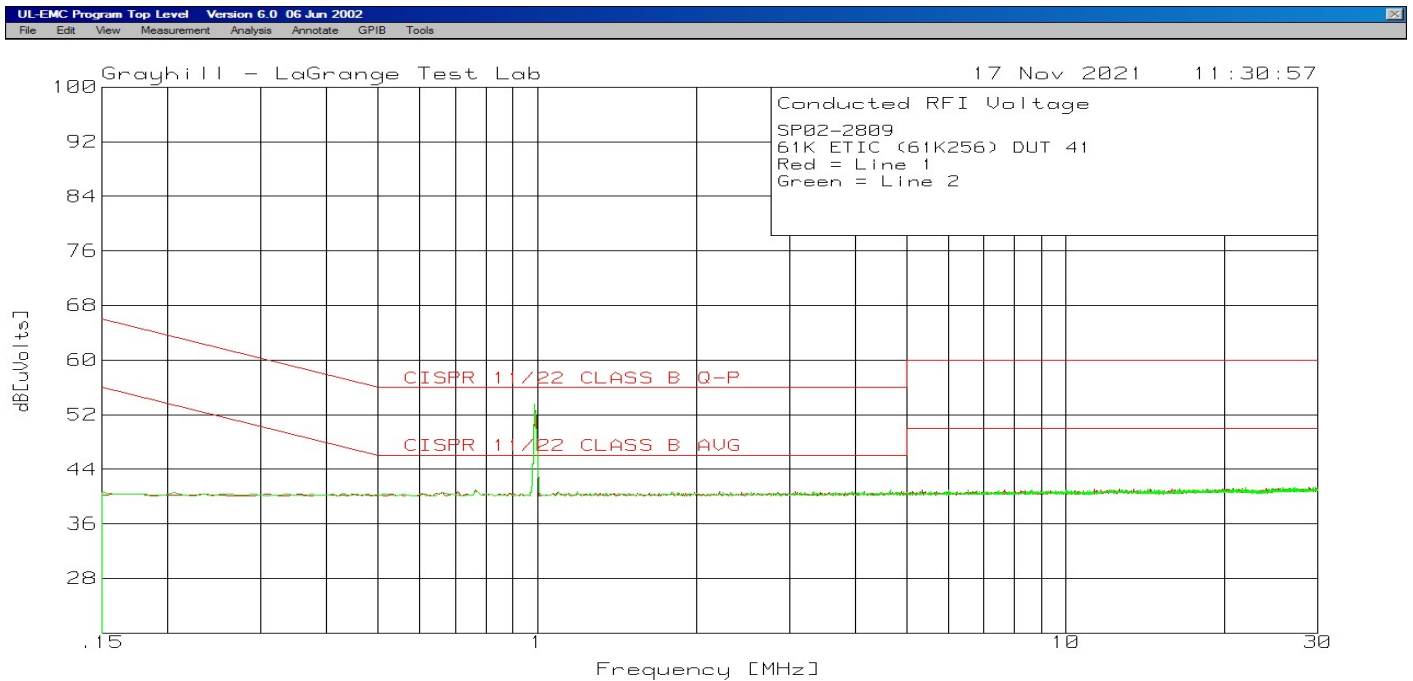
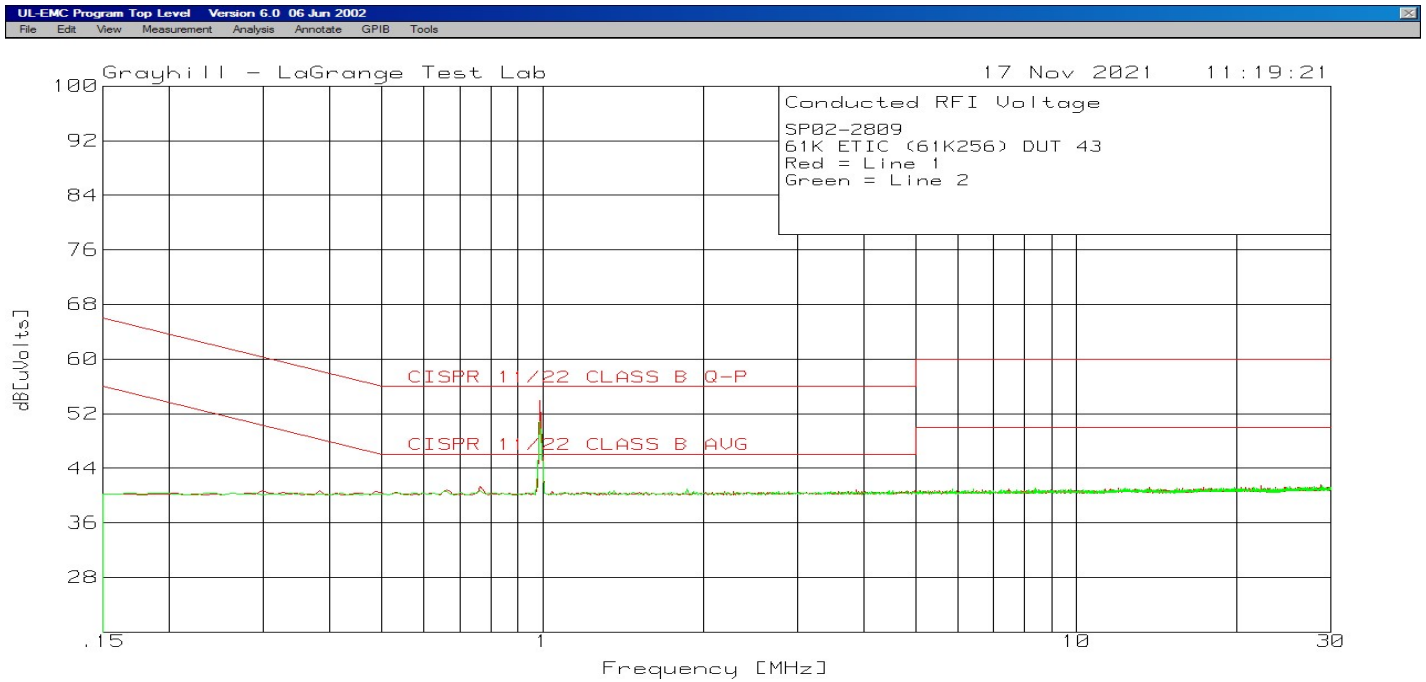
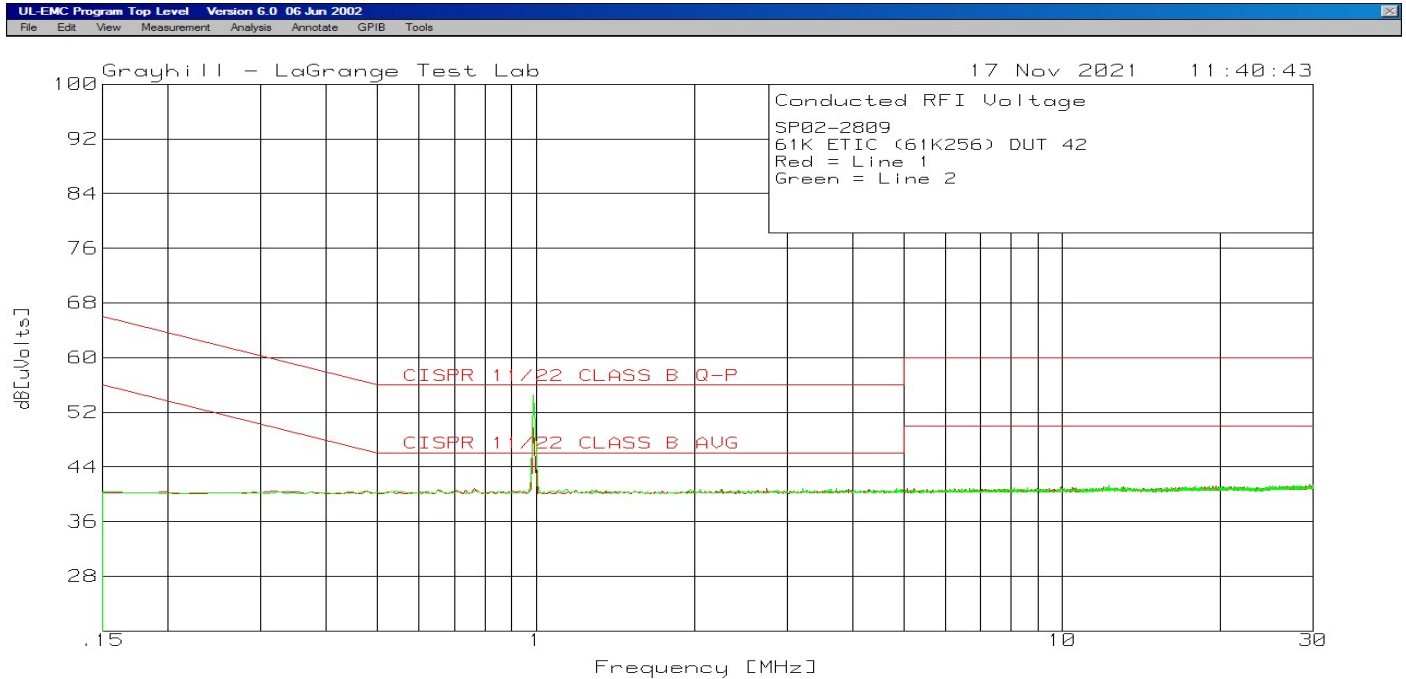

Figure 15 – DUT 41 Conducted Emissions Graph (Test Levels)



3.2.9 TEST SUMMARY

After completion of the test, DUTs passed the BASIC Functionality checks and met the stated Performance Criteria.

3.3 RADIATED IMMUNITY

3.3.1 SUMMARY

DUT Serial Numbers	DUT Part Number	Test Location	Test Dates	Result
41-42-43	61K ETIC (61K256)	Grayhill, Inc.	November 16, 2021	PASS

3.3.2 TEST SPECIFICATION

This test is to be run per 62 Series, Section 11 (EMC Tests) Optical Encoders DV Test Plan and IEC 61000-4-3.

3.3.3 PURPOSE

The purpose of this test is to expose the EUT to radiated electromagnetic fields over the frequency range of 80 MHz to 1.0 GHz with modulation required by EN61000-4-3. The minimum applied field intensity is required to be 10 Volts per meter. The test shall be so repeated that each side of the EUT faces the antenna. For each orientation of the EUT, the radiating antenna shall be positioned so that the E-field polarization is horizontal and vertical.

3.3.4 TEST CONDITIONS

Table 19 – Radiated Immunity Test Conditions

Quantity	3
Temperature (°C)	23.4
Humidity (%Rh)	32.6
Atmospheric Pressure (mB)	1019.8
**Frequency Range (MHz)	**80-1000
Signal Modulation	80% 1kHz sine wave
Test Field Strength	10V/Meter
Operational Mode	Powered & Monitored
Voltage Apply (DC)	5
Performance Criteria	A

**Maximum Test Frequency up to 1.0 GHz only.

3.3.5 TEST PROCEDURE

The tests were performed using standard procedures of the EN61000-4-3 specification. The specific details of the test are described below for each frequency range.

The RF immunity test was repeated so that each side of the DUT was facing the transmitting antenna. For each orientation of the DUT, the radiating antenna was positioned so that the E-field polarization is horizontal and vertical. A computer controlled the signal generator, and spectrum analyzer. The computer maintained the amplitude of the applied signal at or slightly above the required amplitude as recorded during the calibration procedures. If the DUT responded to the applied signal, the amplitude of the signal was reduced and then slowly raised until the threshold of response was determined. The nature of the response was recorded in addition to the frequency and threshold amplitude of the applied signal. The DUT operation was constantly monitored during the tests.

Reference the Quality Standards Manual Test Lab Procedure (QSM-TLP), for details on setting up and running the Radiated Immunity test.

3.3.6 TEST SETUP

Table 20 – Radiated Immunity Equipment List

Equipment ID	Equipment Type	Model Number	Manufacturer	Last Calibrated Date	Calibration Due Date
GT-328	Spectrum Analyzer	8594EM	Hewlett Packard	February 1, 2020	March 1, 2022
GT-329	Signal Generator	8648B	Hewlett Packard	February 1, 2020	March 1, 2022
GT-326	Bilog Antenna	CBL6140A	Schaffner	February 1, 2020	March 1, 2022
GT-325	Pre-Amp	757LCB-CE	Kalmus	March 18, 2020	March 18, 2022
GT-335	EPM Series Power Meter	E4418B	Hewlett Packard	March 11, 2020	March 11, 2022
GT-344	Power Sensor	E4412A	Hewlett Packard	March 19, 2020	March 19, 2022
GT-362	Function Generator	DS345	Stanford Research	March 19, 2020	March 19, 2022
GT-340	Isotropic Field Probe	HI-4422	Holiday	April 16, 2020	April 16, 2022
NA	DC Power Supply	HY3005F-3	Dr. Meter	Calibrate at use	Calibrate at use
PAL-2	Oscilloscope – 1GHz Mixed Signal	MSO7104B	Agilent	December 22, 2020	December 22, 2022
GT-236	True RMS Multimeter	87V	FLUKE	August 30, 2021	August 30, 2022
GT-603	True RMS Multimeter	179	FLUKE	April 06, 2021	April 30, 2022
GT-143	Hygrometer	MDM25	Michel	November 08, 2021	November 30, 2022



Figure 20 – Radiated Immunity Test Setup

3.3.7 COMPLIANCE CRITERIA

The DUT shall pass the BASIC Functionality checks. The DUT shall continue to operate as intended. No degradation of performance or loss of function is allowed below a performance level specified by the manufacturer when the DUT is used as intended.

3.3.8 TEST RESULTS

Table 21 - Results for Radiated Immunity

Frequency (MHz)	Antenna Polarization	DUT Position/Table Orientation	Applied Field (V / m)	DUT # 41 Output Code	DUT # 42 Output Code	DUT # 43 Output Code
80 - 1000	Vertical	Back - 0	10	Pass	Pass	Pass
80 - 1000	Horizontal	Back - 0	10	Pass	Pass	Pass
80 - 1000	Vertical	Left - 90	10	Pass	Pass	Pass
80 - 1000	Horizontal	Left - 90	10	Pass	Pass	Pass
80 - 1000	Vertical	Front - 180	10	Pass	Pass	Pass
80 - 1000	Horizontal	Front - 180	10	Pass	Pass	Pass
80 - 1000	Vertical	Right - 270	10	Pass	Pass	Pass
80 - 1000	Horizontal	Right - 270	10	Pass	Pass	Pass
80 - 1000	Vertical	Top	10	Pass	Pass	Pass
80 - 1000	Horizontal	Top	10	Pass	Pass	Pass
80 - 1000	Vertical	Bottom	10	Pass	Pass	Pass
80 - 1000	Horizontal	Bottom	10	Pass	Pass	Pass

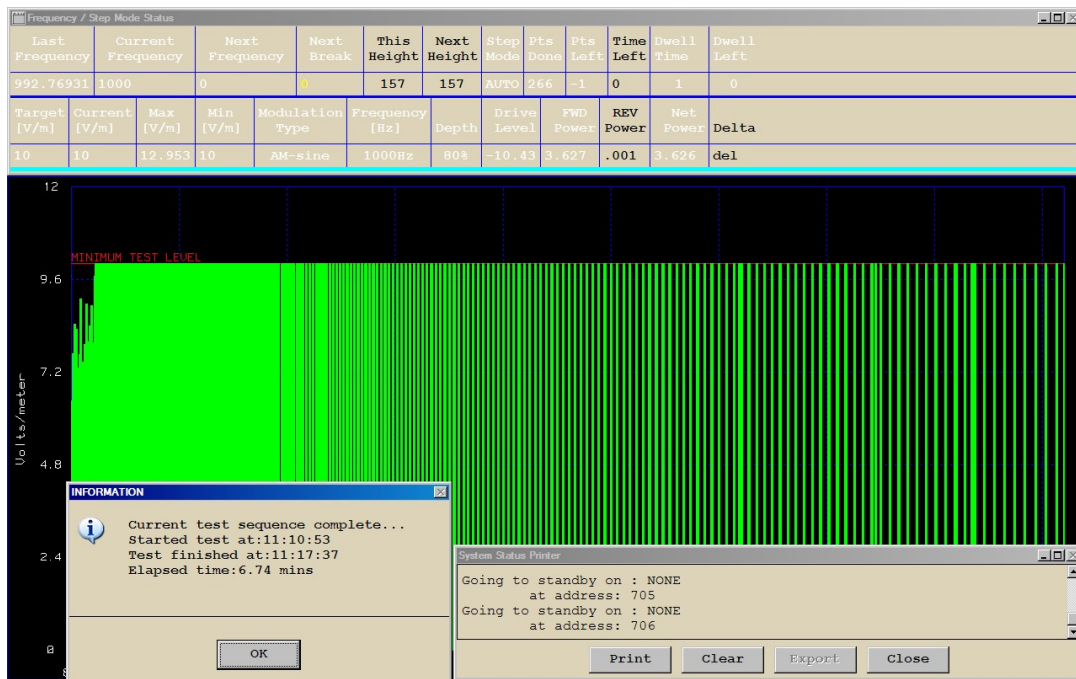

3.3.9 TEST SUMMARY

After completion of the test, DUTs passed the BASIC Functionality checks and met the stated Performance Criteria.

3.4 CONDUCTED IMMUNITY

3.4.1 SUMMARY

DUT Serial Numbers	DUT Part Number	Test Location	Test Dates	Result
41-42-43	61K ETIC (61K256)	Grayhill, Inc.	November 18, 2021	PASS

3.4.2 TEST SPECIFICATION

This test is to be run per 62 Series, Section 11 (EMC Tests) Optical Encoders DV Test Plan and IEC 61000-4-6.

3.4.3 PURPOSE

The purpose of this test is to expose the EUT to RF noise applied to its DC or AC power input leads and I/O leads. The required RF signal is applied over the frequency range of 150 kHz to 80 MHz and has amplitude of 10 Volts rms. The required signal is modulated to a depth of 80% with a 1 kHz sine wave.

3.4.4 TEST CONDITIONS

Table 22 – Conducted Immunity Test Conditions

Quantity	3
Temperature (°C)	23.4
Humidity (%Rh)	32.6
Atmospheric Pressure (mB)	1019.8
Frequency Range (Hz)	150 kHz To 30MHz
Amplitude (Vrms)	10
Signal Modulation	80% 1kHz Sine Wave
Operational Mode	Powered & Monitored
Voltage Apply (DC)	5
Performance Criteria	A

3.4.5 TEST PROCEDURE

Test was performed using standard procedures of the IEC 61000-4-6 specification. DUT was monitored continuously for proper operation during the test. The DUT was positioned on a 10-cm high platform above a ground plane. The CDN was positioned 30 cm from the DUT.

- Perform a BASIC Functionality check before testing has begun
- Perform a BASIC Functionality check after all testing has completed.
- Testing is to be setup per the electrical setup diagram as shown in “ELECTRICAL SETUP FORM”
- Use the values from the Test Conditions section (1.1.4) for all relevant conditions.

3.4.6 TEST SETUP

Table 23 – Conducted Immunity Equipment List

Equipment ID	Equipment Type	Model Number	Manufacturer	Last Calibrated Date	Calibration Due Date
GT-325	Pre-Amp	757LCB-CE	Kalmus	March 18, 2020	March 18, 2022
GT-329	Signal Generator	8648B	Hewlett Packard	February 1, 2020	March 1, 2022
GT-327	Coupling / Decoupling Network	CDN M2/M3	Solar Electronics Co.	August 6, 2020	August 6, 2022
GT-335	EPM Series Power Meter	E4418B	Hewlett Packard	March 11, 2020	March 11, 2022
GT-344	Power Sensor	E4412A	Hewlett Packard	March 19, 2020	March 19, 2022
GT-348	Attenuator	1N100W-6dB	Inmet Corp.	August 6, 2020	August 6, 2022
N/A	DC Power Supply	HY3005F-3	Dr. Meter	Verified With Calibrated Digital Multimeter GT-236	Verified With Calibrated Digital Multimeter GT-236
GT-2110	Digital Phosphor Oscilloscope	DPO2014B	Tektronix	June 09, 2021	June 30, 2022
GT-236	Digital Multimeter	87V	FLUKE	August 30, 2021	August 30, 2022
GT-603	True RMS Multimeter	179	FLUKE	April 06, 2021	April 30, 2022
GT-143	Hygrometer	MDM25	Michel	October 22, 2020	October 31, 2021

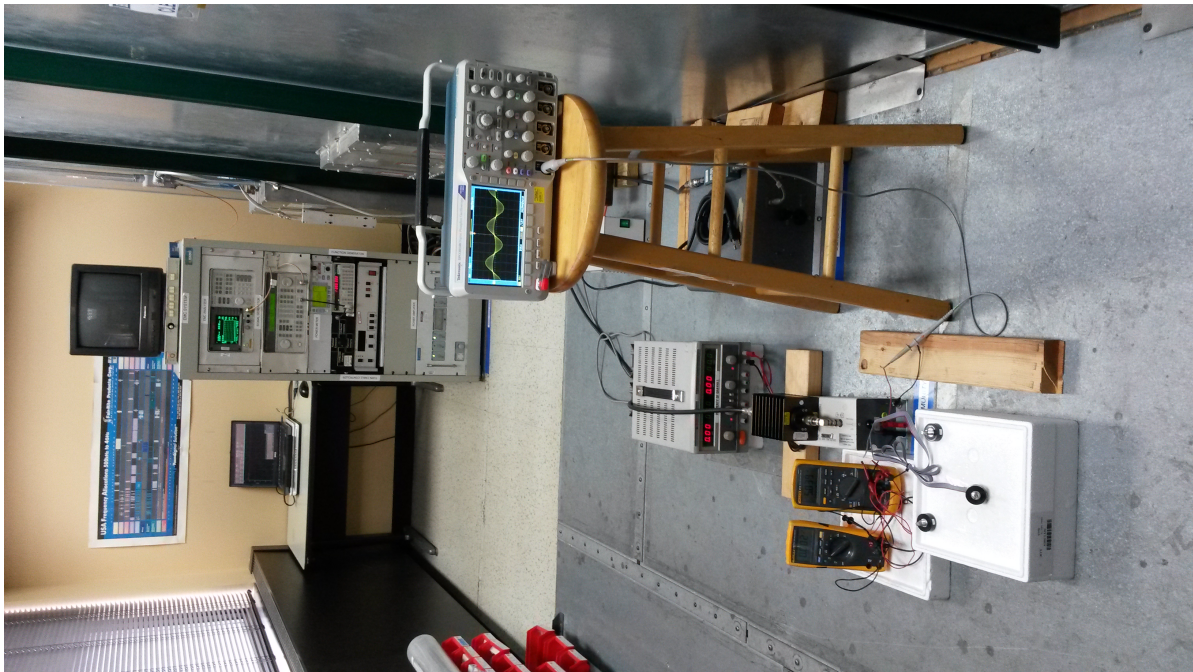

Figure 22 – Conducted Immunity Test Setup

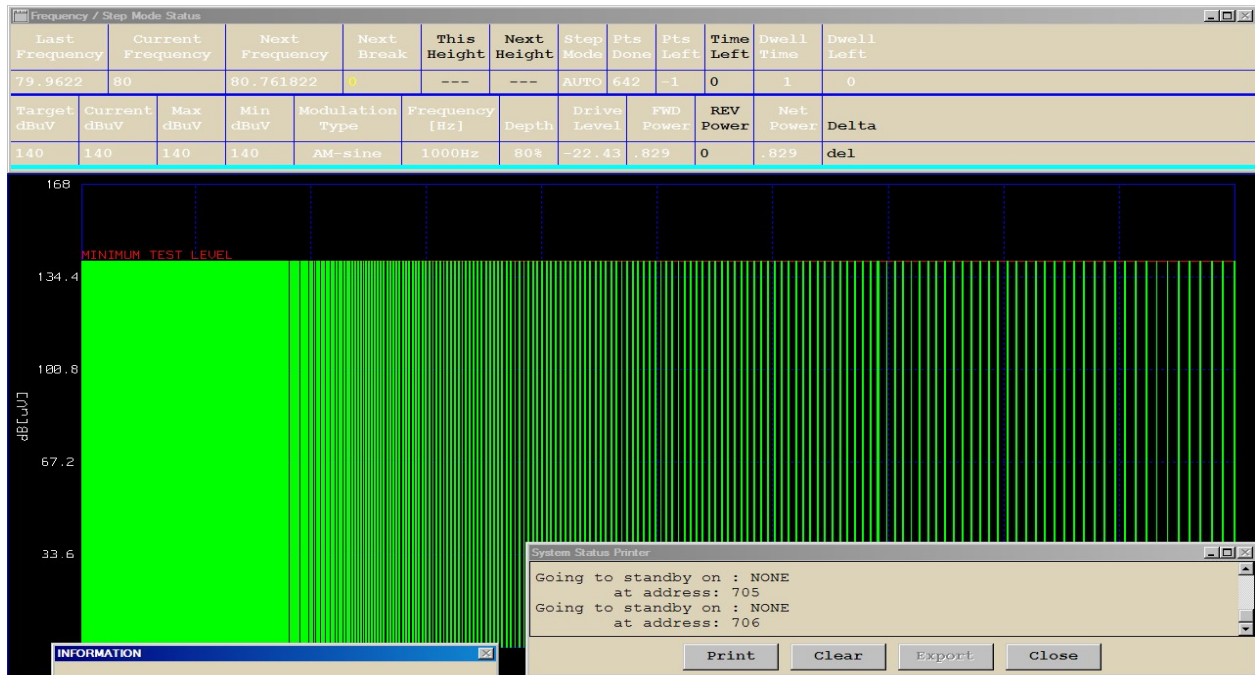

Figure 23 – Conducted Immunity Test Level (10Vrms or 140dB [μVolt])

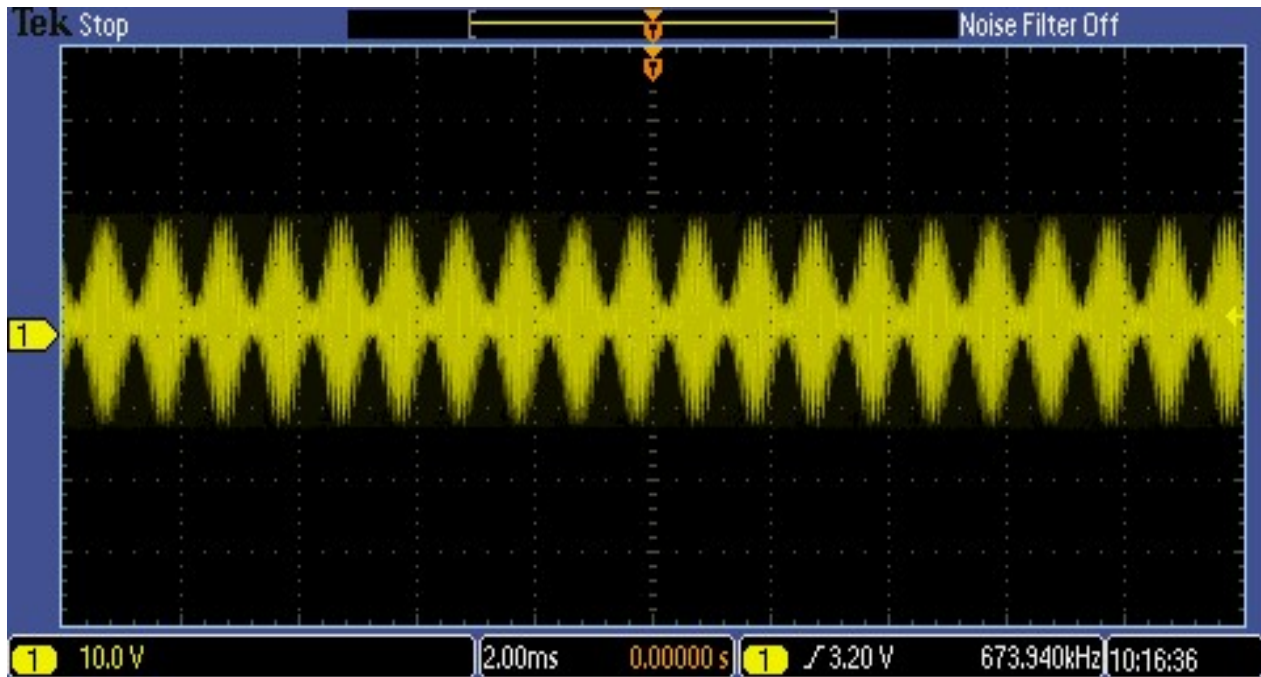

Figure 24 – Test Level Verification

3.4.7 COMPLIANCE CRITERIA

The DUT shall pass the BASIC Functionality checks.

The DUT shall continue to operate as intended. No degradation of performance or loss of function is allowed below a performance level specified by the manufacturer when the DUT is used as intended.

3.4.8 TEST RESULTS

Table 24 - Results for Conducted Immunity

DUT No. 41	November 18, 2021	Pass
DUT No. 42	November 18, 2021	Pass
DUT No. 43	November 18, 2021	Pass

3.4.9 TEST SUMMARY

After completion of the test, DUTs passed the BASIC Functionality checks and met the stated Performance Criteria.

3.5 POWER FREQUENCY MAGNETIC FIELD

3.5.1 SUMMARY

DUT Serial Numbers	DUT Part Number	Test Location	Test Dates	Result
41-42-43	61K ETIC (61K256)	Grayhill, Inc.	November 19, 2021	PASS

3.5.2 TEST SPECIFICATION

This test is to be run per 62 Series, Section 11 (EMC Tests) Optical Encoders DV Test Plan and IEC 61000-4-8.

3.5.3 PURPOSE

The purpose of this test is to expose the DUT to a magnetic field using an induction coil of standard dimensions (1m x 1m). The coil shall be placed at a distance of 0.1m from the DUT. The test generator shall be placed at a distance of 3 meters from the induction coil. One terminal of the generator will be connected to the ground plane. The induction coil will then be rotated by 90 degrees in order to expose the DUT to the test field with different orientations.

3.5.4 TEST CONDITIONS

Table 25 – Power Frequency Magnetic Field Test Conditions

Quantity	3
Temperature (°C)	23.4
Humidity (%Rh)	32.6
Atmospheric Pressure (mB)	1019.8
Test Level (A/m)	30A/m (Level 4)
Test Frequency	50Hz & 60Hz
Operational Mode	Powered & Monitored
Voltage Apply (DC)	5
Mating Connector Attached	Yes
Performance Criteria	A

3.5.5 TEST PROCEDURE

Test was performed using standard procedures of the IEC 61000-4-8 specification. DUT was monitored continuously for proper operation during the test.

1. Perform a BASIC Functionality check before testing has begun.
2. Testing is to be setup per the electrical setup diagram as shown in “ELECTRICAL SETUP FORM”.
3. Place DUT on 80 cm high table and subjected to a magnetic field using an induction coil of standard dimensions (1m x 1m)
4. Place the coil at a distance of 0.1m from DUT.
5. Place test generator at a distance of 3 meters from the induction coil.
6. Rotate induction coil by 90 degrees in order to expose the DUT to the test field with different orientations.
7. Verify DUT performance during the test to assure that DUT is not loose function during testing.
8. Use the values from the Test Conditions section (1.1.4) for all relevant conditions.
9. Perform a BASIC Functionality check after all testing has completed.

3.5.6 TEST SETUP

Table 26 – Power Frequency Magnetic Field Equipment List

Equipment ID	Equipment Type	Model Number	Manufacturer	Last Calibrated Date	Calibration Due Date
GT-334	ELF Magnetic Field Sensor	HI-3624A	Holiday	January 21, 2021	January 31, 2023
GT-2202	MFO	MFO 6502	Teseq AG	December 19, 2019	December 31, 2019
GT-2211	MF Coil	INA 702	Teseq AG	Not Required	Not Required
GT-2211-1	Power Coil Factor	9.8	Teseq AG	December 19, 2019	December 31, 2019
GT-2200	Generator	FTM-3425	Teseq AG	December 19, 2019	December 31, 2019
N/A	DC Power Supply	HY3005F-3	Dr. Meter	Verified With Calibrated Digital Multimeter GT-236	Verified With Calibrated Digital Multimeter GT-236
GT-2110	Digital Phosphor Oscilloscope	DPO2014B	Tektronix	June 09, 2021	June 30, 2022
GT-236	Digital Multimeter	87V	FLUKE	August 30, 2021	August 30, 2022
GT-603	True RMS Multimeter	179	FLUKE	April 06, 2021	April 30, 2022
GT-143	Hygrometer	MDM25	Michel	October 22, 2020	October 31, 2021

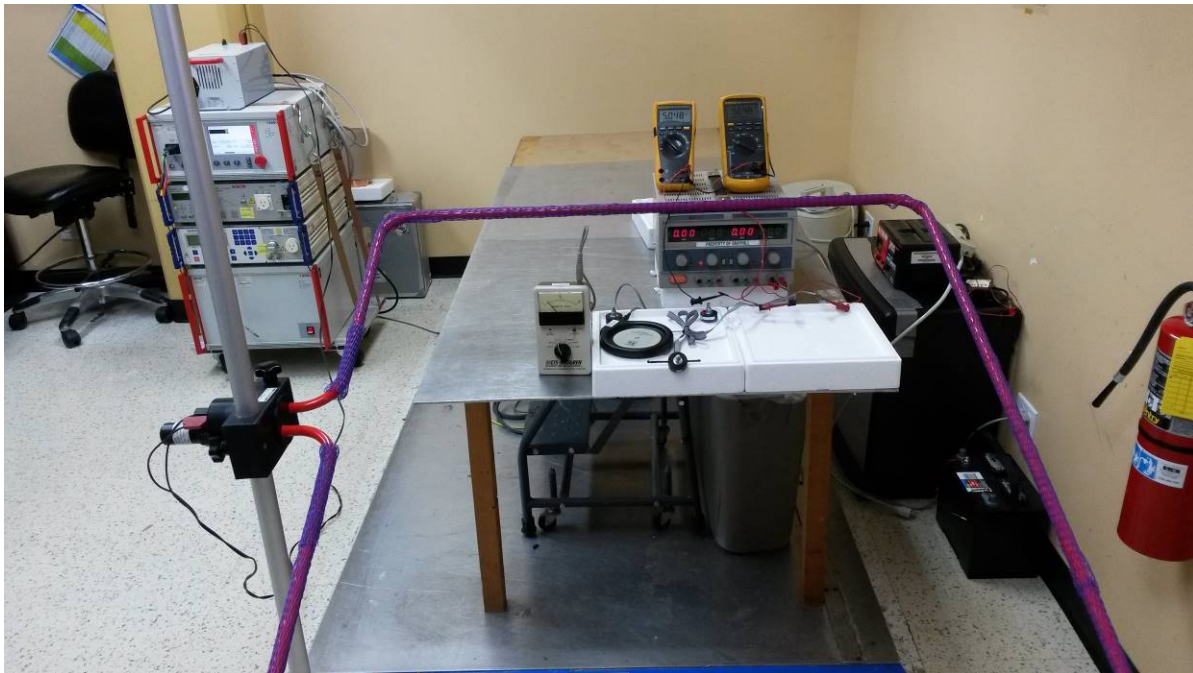

Figure 25 – Power Frequency Magnetic Field Test Setup



Figure 26 – Electrical Test Setup



Figure 27 – Test Level

3.5.7 COMPLIANCE CRITERIA

The DUT shall pass the BASIC Functionality checks.

The DUT shall continue to operate as intended. No degradation of performance or loss of function is allowed below a performance level specified by the manufacturer when the DUT is used as intended.

3.5.8 TEST RESULTS

Table 27 - Results for Power Frequency Magnetic Field

DUT No. 41	November 19, 2021	Pass
DUT No. 42	November 19, 2021	Pass
DUT No. 43	November 19, 2021	Pass

3.5.9 TEST SUMMARY

After completion of the test, DUTs passed the BASIC Functionality checks and met the stated Performance Criteria.

3.6 ELECTROSTATIC DISCHARGE

3.6.1 SUMMARY

DUT Serial Numbers	DUT Part Number	Test Location	Test Dates	Result
41-42-43	61K ETIC (61K256)	Grayhill, Inc.	November 19, 2021	PASS

3.6.2 TEST SPECIFICATION

This test is to be run per 62 Series, Section 11 (EMC Tests) Optical Encoders DV Test Plan and IEC 61000-4-2.

3.6.3 PURPOSE

The purpose of this test is to expose the DUT to Electrostatic discharges at 8kV using the air discharge method and to Electrostatic discharges at 4kV using the contact discharge method. Testing also shall be satisfied at the lower levels. The potential product issue modes and effects detected in this test are:

- Anomalies in performance
- Intermittent operation
- Failure of electrical components

3.6.4 TEST CONDITIONS

Table 28 – Electrostatic Discharge Test Conditions

Quantity	3
Temperature (°C)	23.4
Humidity (%Rh)	32.6
Atmospheric Pressure (mB)	1019.8
Discharge Network	150 pF / 330 Ohms
Contact Discharge	+/-4kV, Continue to failure & record level
Air Discharge	+/-2, +/-4, +/-8, Continue to failure & record level
Indirect Discharge Voltage	+/-4 (Horizontal Coupling Plane)
Indirect Discharge Voltage	+/-4 (Vertical Coupling Plane)
Operational Mode	Powered & Monitored
Voltage Apply (DC)	5VDC
Mating Connector Attached	Yes
Performance Criteria	B

3.6.5 TEST PROCEDURE

Test was performed using standard procedures of the IEC 61000-4-2 specification. DUT was monitored continuously for proper operation during the test. The specific details of the test are described below.

1. Perform a BASIC Functionality check before testing has begun.
2. Mount the DUT in the Mounting Orientation specified in the Test Conditions Table 1 if applicable.
3. Load the discharge network specified in the Test Conditions Table 1.
4. Apply the pulse to the DUT in the sequence specified in the Test Conditions Table 1.
5. Perform functional check after each voltage level
6. Perform a BASIC Functionality check after all testing has completed.

3.6.6 TEST SETUP

Table 29 – Electrostatic Discharge Equipment List

Equipment ID	Equipment Type	Model Number	Manufacturer	Last Calibrated Date	Calibration Due Date
GT-361	ESD Generator	NSG 438	Teseq	Dec 17, 2020	Dec 31, 2022
GT-361A	Discharge Network 150pF / 330Ω	INA 4380	Teseq	Dec 17, 2020	Dec 31, 2022
N/A	115Vac To 5VDC Converter	24MS	Sola Electric	Verified at Use	Verified at Use
N/A	DC Power Supply	HY3005F-3	Dr. Meter	Verified With Calibrated Digital Multimeter GT-236	Verified With Calibrated Digital Multimeter GT-236
GT-236	Digital Multimeter	87V	FLUKE	August 30, 2021	August 30, 2022
GT-603	True RMS Multimeter	179	FLUKE	April 06, 2021	April 30, 2022
GT-143	Hygrometer	MDM25	Michel	October 22, 2020	October 31, 2021

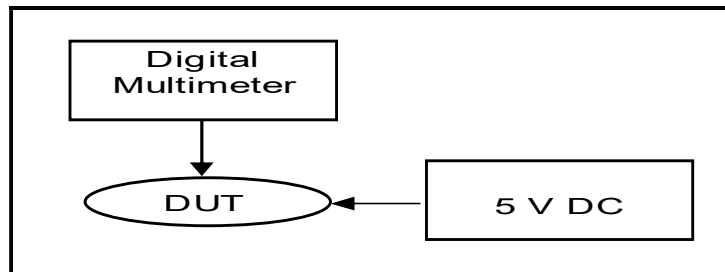

Figure 28 - DUT Configuration



Figure 29 – Electrostatic Discharge Test Setup

3.6.7 COMPLIANCE CRITERIA (B)

The apparatus shall continue to operate as intended after the test. No degradation of performance or loss of function is allowed below a performance level specified by the manufacturer when the apparatus is used as intended. In some cases, the performance level may be replaced by a permissible loss of performance. During the test, degradation of performance is, however, allowed. No change of actual operating state or stored data is allowed. If the minimum performance level or the permissible performance loss is not specified by the manufacturer, then either of these may be derived from the product description and documentation and what the user may reasonably expect from the apparatus if used as intended.

3.6.8 TEST RESULTS

Table 30 - Results for Electrostatic Discharge

DUT No. 41	November 19, 2021	Pass
DUT No. 42	November 19, 2021	Pass
DUT No. 43	November 19, 2021	Pass

3.6.9 TEST SUMMARY

After completion of the test, DUTs passed the BASIC Functionality checks and met the stated Performance Criteria B.

Table 31 – DUT No. 41 Results for Electrostatic Discharge

Discharge Location	Applied Levels	Type	Number of Tries / Failures	Test Results
Shaft	+/-4kV	Contact	10 / 0	Pass
Housing	+/-2kV, +/-4kV, +/-8kV	Air	10 / 0	Pass
Horizontal Coupling Plane	+/-4kV	Contact	10 / 0	Pass
Vertical Coupling Plane	+/-4kV	Contact	10 / 0	Pass

Table 32 – DUT No. 42 Results for Electrostatic Discharge

Discharge Location	Applied Levels	Type	Number of Tries / Failures	Test Results
Shaft	+/-4kV	Contact	10 / 0	Pass
Housing	+/-2kV, +/-4kV, +/-8kV	Air	10 / 0	Pass
Horizontal Coupling Plane	+/-4kV	Contact	10 / 0	Pass
Vertical Coupling Plane	+/-4kV	Contact	10 / 0	Pass

Table 33 – DUT No. 43 Results for Electrostatic Discharge

Discharge Location	Applied Levels	Type	Number of Tries / Failures	Test Results
Shaft	+/-4kV	Contact	10 / 0	Pass
Housing	+/-2kV, +/-4kV, +/-8kV	Air	10 / 0	Pass
Horizontal Coupling Plane	+/-4kV	Contact	10 / 0	Pass
Vertical Coupling Plane	+/-4kV	Contact	10 / 0	Pass