

# HIGH PRESSURE CONNECTORS

 SERIES



 **LEMO**

## Precision modular connectors to suit your application

Since its creation in Switzerland in 1946 the LEMO Group has been recognized as a global leader of circular Push-Pull connectors and connector solutions. Today LEMO and its affiliated companies, REDEL and COELVER, are active in more than 80 countries with the help of over 40 subsidiaries and distributors.

## Over 75000 connectors

The modular design of the LEMO range provides over 75000 connectors from miniature  $\varnothing$  3 mm to  $\varnothing$  50 mm, capable of handling cable diameters up to 30 mm and for up to 114 contacts.

This vast portfolio enables you to select the ideal connector configuration to suit almost any specific requirement in most markets, including medical devices, test and measurement instruments, machinery, audio video broadcast, telecommunications and military.

## LEMO's Push-Pull Self-Latching Connection System (not shown in this catalogue)

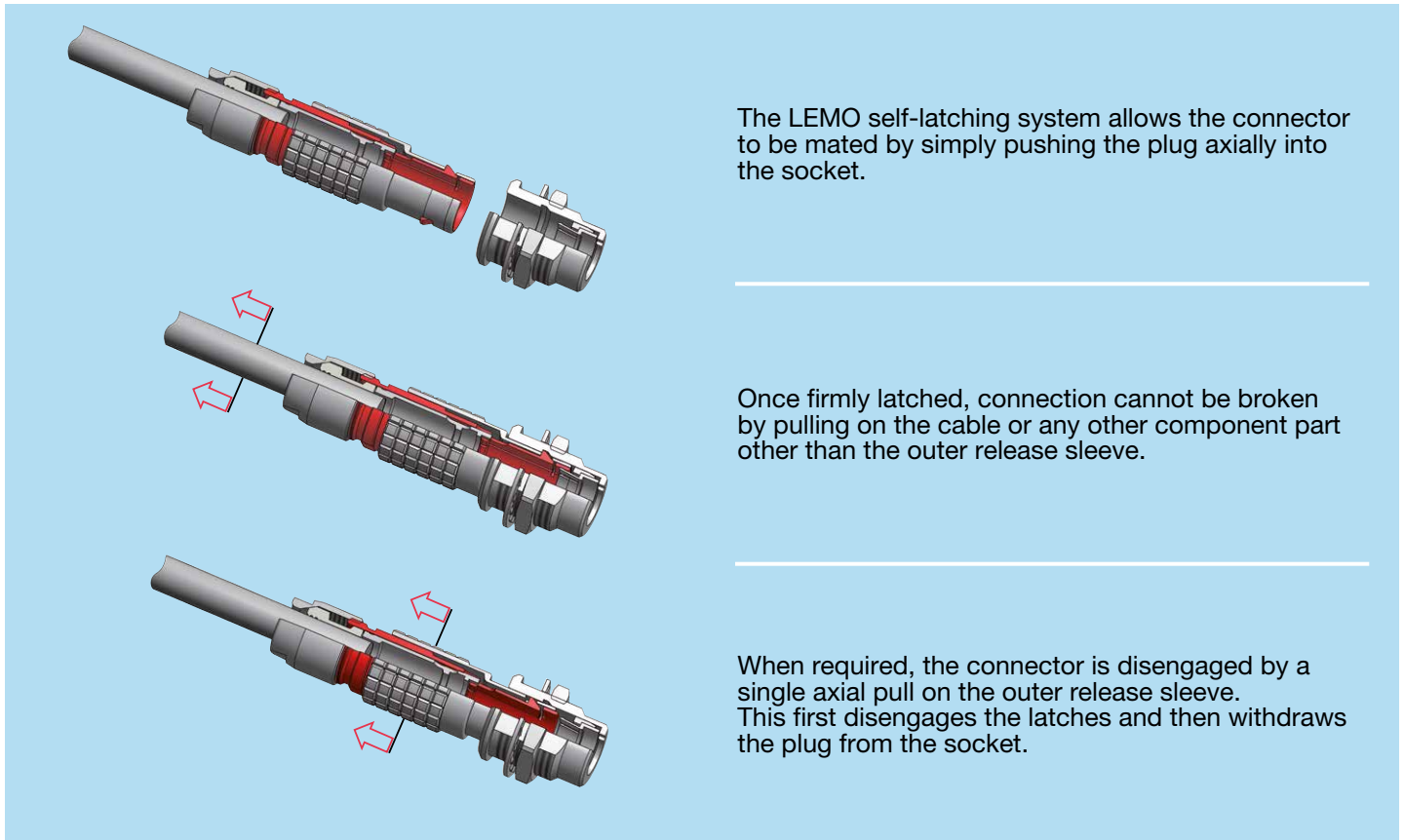

This self-latching system is renowned worldwide for its easy and quick mating and unmating features. It provides absolute security against vibration, shock or pull on the cable, and facilitates operation in a very limited space.



## UL Recognition

LEMO connectors are recognized by the Underwriters Laboratories (UL). The approval of the complete system (LEMO connector, cable and your equipment) will be easier because LEMO connectors are recognized.

## CE marking

CE marking  means that the appliance or equipment bearing it complies with the protection requirements of one or several European safety directives. CE marking  applies to complete products or equipment, **but not to electromechanical components, such as connectors.**

## RoHS

LEMO connector specifications conforms the requirements of the RoHS directive (2011/65/EU) of the European Parliament and the latest amendments. This directive specifies the restrictions of the use of hazardous substances in electrical and electronic equipment marketed in Europe.

# 03 Series

This series of connectors stems from the series 00 and has been specifically developed for applications where the connection must be guaranteed under very high pressure. The push-pull latching system has been replaced by a screw coupling system with watertightness maintained by compression of an O-ring in FPM (Viton®) according to the triangular shaped cavity principle. There are multiple application possibilities, from aerospace to the petroleum industry.

After cable assembly, the rear part must be covered with an adhesive heatshrink boot in order to ensure watertightness on the cable side. 03 series connectors provide the following main features:

- coaxial 50 Ω type
- multipole with 2, 3, 4 or 6 contacts
- 360° screening for full EMC shielding
- rugged housing for extreme working conditions
- working pressure that can exceed 60 bars in mated conditions

## Multipole Type (302, 303, 304, 306)

### Models (page 3)

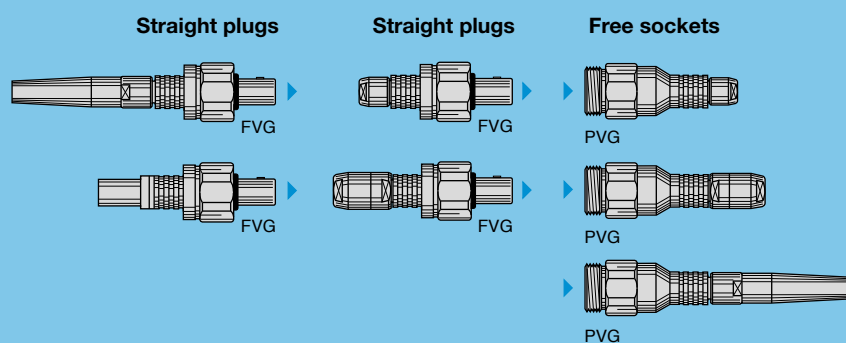

### Vacuumtight models (page 5)

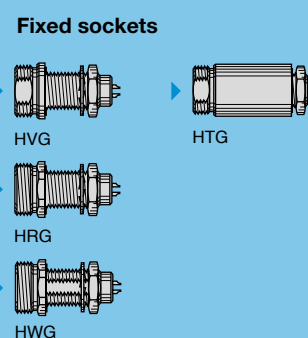

## Coaxial Type (50 Ω)

### Models (page 6)

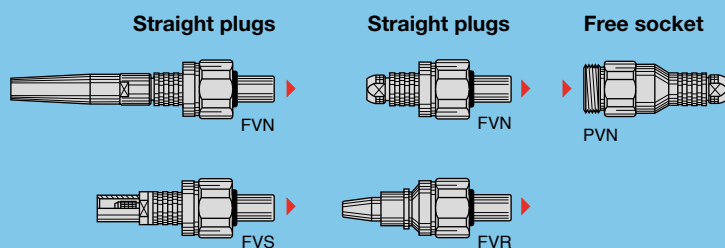

### Vacuumtight models (page 8)

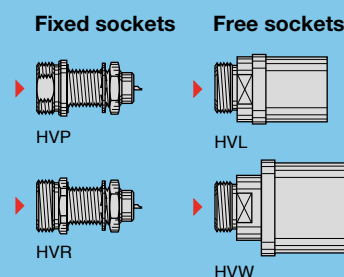



## Part Numbering System

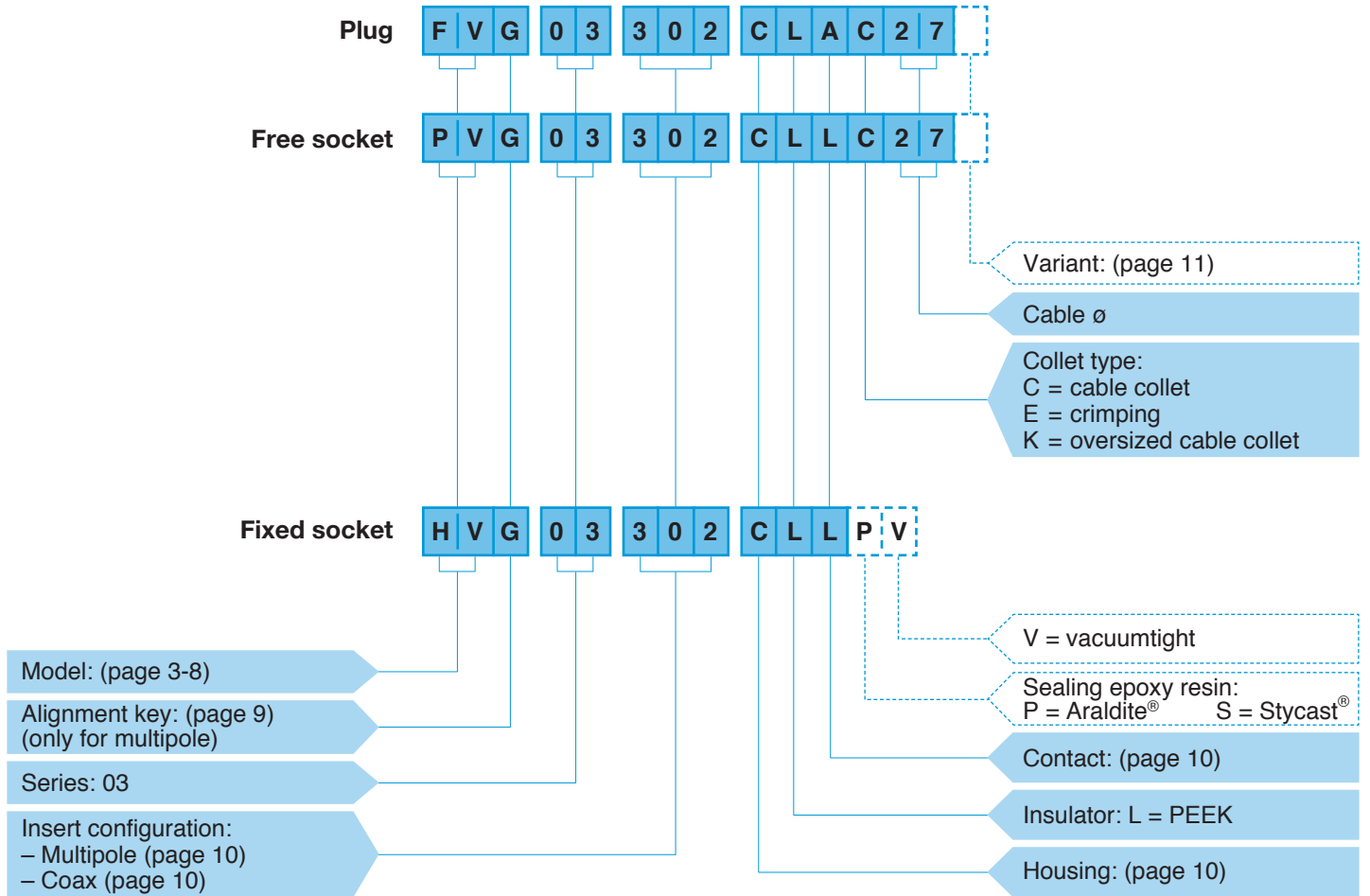

**FVG.03.302.CLAC27** = straight plug with key (G) and cable collet, 03 series, multipole type with 2 contacts, outer shell in chrome-plated brass, PEEK insulator, male solder contacts, C type collet for 2.7 mm diameter cable.

**PVG.03.302.CLLC27** = free socket with key (G) and cable collet, 03 series, multipole type with 2 contacts, outer shell in chrome-plated brass, PEEK insulator, female solder contacts, C type collet for 2.7 mm diameter cable.

**HVG.03.302.CLLPV** = fixed socket, nut fixing, with key (G), 03 series, multipole type with 2 contacts, outer shell in chrome-plated brass, PEEK insulator, female solder contacts, sealed with Araldite® epoxy resin.

## Part Section Showing Internal Components (multipole)

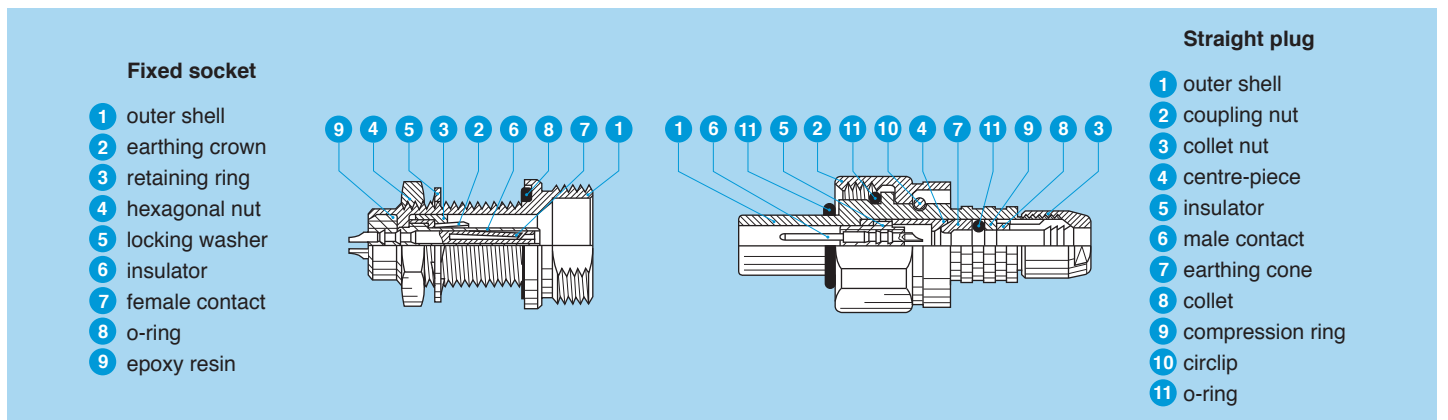



## Models (multipole type)

### Technical Characteristics

#### Mechanical and Climatical

Characteristics	Value	Standard
Endurance	> 1000 cycles	IEC 60512-5 test 9a
Humidity	up to 95% at 60° C	
Temperature range	-20° C, +200° C	
Salt spray corrosion test <sup>5)</sup>	> 1000 h	IEC 60512-6 test 11f
Protection index <sup>2)</sup>	> IP68	IEC 60529
Resistance to hydrostatic pressure <sup>2)</sup>	~ 60 bars <sup>1)</sup>	IEC 60512-7 test 14d
Climatical category	20/200/21	IEC 60068-1

**Note:**

- <sup>1)</sup> in order to perform correctly and withstand the pressure, cable assembly shall be made according to instruction we recommend. See page 12.  
<sup>2)</sup> For mated plug and socket.  
<sup>3)</sup> after humidity test: 21 days at 95% RH according to IEC 60068-2.

#### Electrical

Characteristics	Value	Standard	Section
Insulation resistance (new)	> 10 <sup>12</sup> Ω	IEC 60512-2	test 3a
Insulation resistance <sup>3)</sup>	> 10 <sup>10</sup> Ω	IEC 60512-2	test 3a
Shell electrical continuity	5.0 mΩ	IEC 60512-2	test 2f
Shielding efficiency	at 10 MHz	> 100 dB	IEC 60169-1-3
	at 1 GHz	> 80 dB	IEC 60169-1-3
Contact resistance <sup>4)</sup>	ø A = 0.5 mm	≤ 8.7 mΩ	IEC 60512-2 test 2a
	ø A = 0.7 mm	≤ 6.1 mΩ	IEC 60512-2 test 2a

**Note:**

- <sup>4)</sup> after 5000 mating cycles and the salt spray test according to IEC 60512-6 test 11 f.  
<sup>5)</sup> for chrome plated product (« C » material code).

#### FVG Straight plug, key (G) or key (B), cable collet

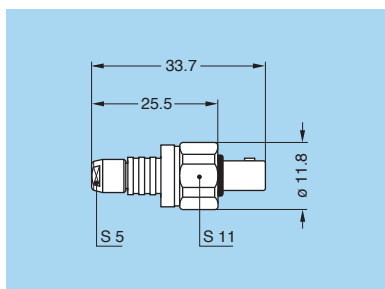

Part number	Cable ø (mm)	
	min.	max.
<b>FVG.03.30●.CLAC27</b>	2.4	2.6
<b>FVG.03.30●.SLAC27</b>	2.4	2.6
<b>FVG.03.30●.CLAC31</b>	2.7	3.0
<b>FVG.03.30●.SLAC31</b>	2.7	3.0

**Note:** ● = insert configuration (page 10)

#### FVG Straight plug, key (G) or key (B), cable collet and nut for fitting a bend relief

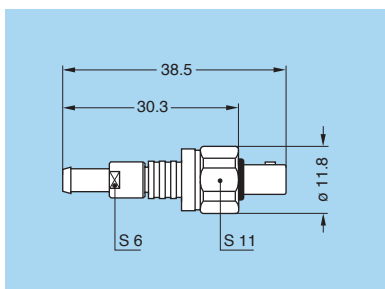

Part number	Cable ø (mm)	
	min.	max.
<b>FVG.03.30●.CLAC27Z</b>	2.4	2.6
<b>FVG.03.30●.SLAC27Z</b>	2.4	2.6
<b>FVG.03.30●.CLAC31Z</b>	2.7	3.0
<b>FVG.03.30●.SLAC31Z</b>	2.7	3.0

**Note:** ● = insert configuration (page 10).  
The bend relief must be ordered separately (page 11)

#### FVG Straight plug, key (G) or key (B) and oversize cable collet

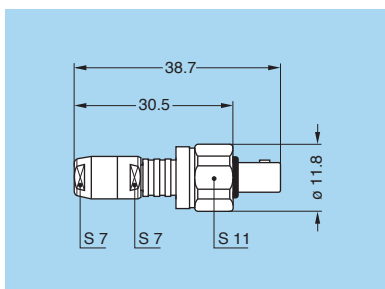

Part number	Cable ø (mm)	
	min.	max.
<b>FVG.03.30●.CLAK35</b>	3.1	3.5
<b>FVG.03.30●.CLAK40</b>	3.6	4.0
<b>FVG.03.30●.CLAK45</b>	4.1	4.5
<b>FVG.03.30●.CLAK50</b>	4.6	5.0

**Note:** ● = insert configuration (page 10)  
Correspond to K type of collet. Also available with nut for fitting a bend relief.



### FVG Straight plug, key (G) for cable crimping

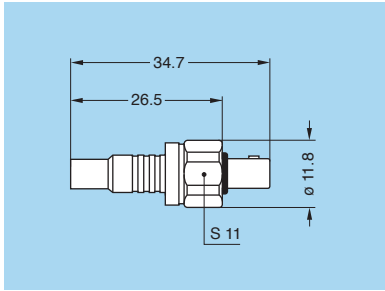

Part number	Cable $\phi$ (mm)	
	max.	
<b>FVG.03.30●.CLAE44</b>	4.3	
<b>FVG.03.30●.SLAE44</b>	4.3	
<b>FVG.03.30●.CLAE52</b>	5.1	
<b>FVG.03.30●.SLAE52</b>	5.1	

**Note:** ● = insert configuration (page 10)

### PVG Free socket, key (G) and cable collet

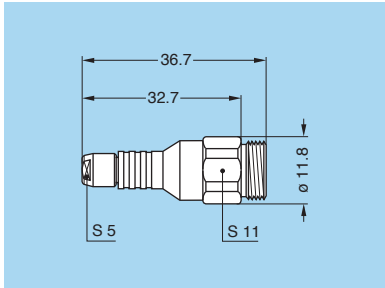

Part number	Cable $\phi$ (mm)	
	min.	max.
<b>PVG.03.30●.CLLC27</b>	2.4	2.6
<b>PVG.03.30●.CLLC31</b>	2.7	3.0

**Note:** ● = insert configuration (page 10)

### PVG Free socket, key (G), cable collet and nut for fitting a bend relief

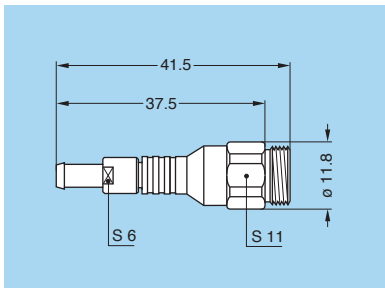

Part number	Cable $\phi$ (mm)	
	min.	max.
<b>PVG.03.30●.CLLC27Z</b>	2.4	2.6
<b>PVG.03.30●.CLLC31Z</b>	2.7	3.0

**Note:** ● = insert configuration (page 10).  
The bend relief must be ordered separately (page 11)

### PVG Free socket, key (G) and oversize cable collet

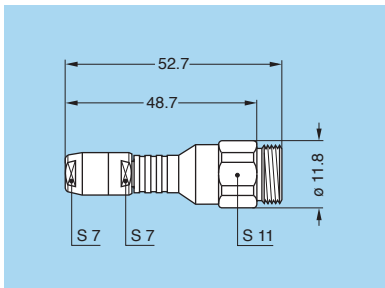

Part number	Cable $\phi$ (mm)	
	min.	max.
<b>PVG.03.30●.CLLK35</b>	3.1	3.5
<b>PVG.03.30●.CLLK40</b>	3.6	4.0
<b>PVG.03.30●.CLLK45</b>	4.1	4.5
<b>PVG.03.30●.CLLK50</b>	4.6	5.0

**Note:** ● = insert configuration (page 10)  
Correspond to K type of collet. Also available with nut for fitting a bend relief.



## Vacuumtight models (multipole type)

These sockets models allow the device on which they are fitted to reach a protection index of IP68 as per IEC 60529. They are fully compatible with plugs of the same series and are widely used for portable radios, military, laboratory equipment, aviation, etc.

These models are identified by a letter «P» or «S» at the last but one character of the reference. The Stycast® sealant can be used over a larger temperature range than the Araldite® sealant.

Vacuumtight models are identified by an additional letter «V» at the end of the part number (certificate on request). Epoxy resin is used to seal these models.

### Technical Characteristics

#### Mechanical and Climatical

Characteristics	Value	Standard
Endurance	> 1000 cycles	IEC 60512-5 test 9a
Humidity	up to 95% at 60° C	
Temperature range	-20° C, +100° C	
Salt spray corrosion test <sup>3)</sup>	> 1000 h	IEC 60512-6 test 11f

Characteristics	Value	Standard
Climatical category	20/80/21	IEC 60068-1
Leakage rate (He) <sup>1)</sup>	< 10 <sup>-7</sup> mbar.l.s <sup>-1</sup>	IEC 60512-7 test 14b
Max. operating pressure <sup>2)</sup>	60 bars	IEC 60512-7 test 14d

**Note:**

<sup>1)</sup> only for vacuumtight models.

<sup>2)</sup> this value corresponds to the maximum allowed pressure difference for the assembled socket.

<sup>3)</sup> for chrome plated product («C» material code).

#### HVG Fixed socket, key (G) or key (B), round flange, nut fixing, vacuumtight

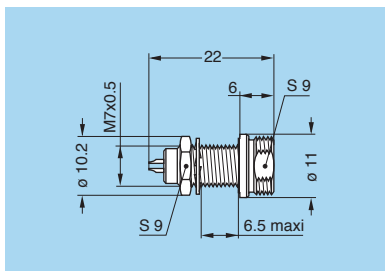

Part number	Sealing resin
HVG.03.30●.CLLPV	Araldite®
HVG.03.30●.SLLPV	Araldite®
HVG.03.30●.CLLSV	Stycast®
HVG.03.30●.SLLSV	Stycast®

Panel cut-out (page 11)

**Note:** ● = insert configuration (page 10)

#### HWG Fixed socket, key (G), hexagonal flange, nut fixing, vacuumtight

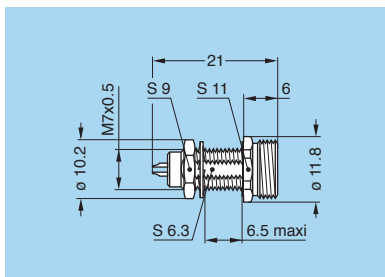

Part number	Sealing resin
HWG.03.30●.CLLPV	Araldite®
HWG.03.30●.CLLSV	Stycast®

Panel cut-out (page 11)

**Note:** ● = insert configuration (page 10)

#### HRG Fixed socket, key (G), hexagonal flange, nut fixing, no flats on fixing thread, vacuumtight

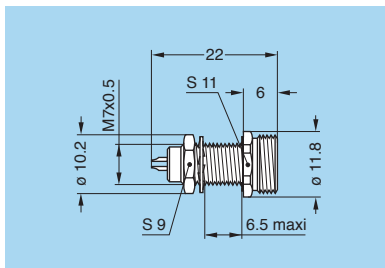

Part number	Sealing resin
HRG.03.30●.CLLPV	Araldite®
HRG.03.30●.SLLPV	Araldite®
HRG.03.30●.CLLSV	Stycast®
HRG.03.30●.SLLSV	Stycast®

Panel cut-out (page 11)

**Note:** ● = insert configuration (page 10)



## HTG Fixed socket, key (G), nut fixing, long shell

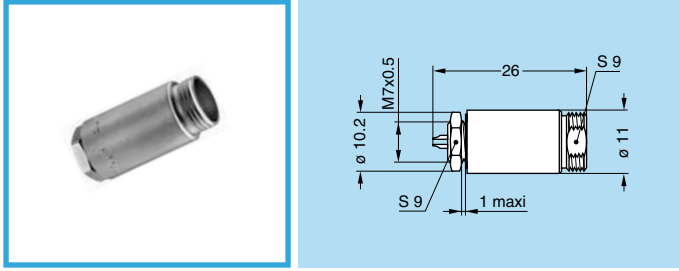

Part number	Sealing resin
<b>HTG.03.30●.CLLSV</b>	Stycast®

Panel cut-out (page 11)

**Note:** ● = insert configuration (page 10)



## Models (coaxial type)

### Technical Characteristics

#### Mechanical and Climatrical

Characteristics	Value	Standard
Endurance	> 1000 cycles	IEC 60512-5 test 9a
Humidity	up to 95% at 60° C	
Temperature range	-20° C, +200° C	
Salt spray corrosion test <sup>5)</sup>	> 1000 h	IEC 60512-6 test 11f
Protection index <sup>2)</sup>	> IP68	IEC 60529
Resistance to hydrostatic pressure <sup>2)</sup>	~ 60 bars <sup>1)</sup>	IEC 60512-7 test 14d
Climatrical category	20/200/21	IEC 60068-1

**Note:**

- <sup>1)</sup> in order to perform correctly and withstand the pressure, cable assembly shall be made according to instruction we recommend. See page 12.
- <sup>2)</sup> for mated plug and socket.
- <sup>3)</sup> after humidity test: 21 days at 95% RH according to IEC 60068-2.

#### Electrical

Characteristics	Value	Standard	Section
Insulation resistance (new)	> 10 <sup>12</sup> Ω	IEC 60512-2	test 3a
Insulation resistance <sup>3)</sup>	> 10 <sup>10</sup> Ω	IEC 60512-2	test 3a
Shell electrical continuity	5.0 mΩ	IEC 60512-2	test 2f
Shielding efficiency	at 10 MHz	> 100 dB	IEC 60169-1-3
	at 1 GHz	> 80 dB	IEC 60169-1-3
Contact resistance <sup>4)</sup>	∅ A = 0.5 mm	≤ 8.7 mΩ	IEC 60512-2
	∅ A = 0.7 mm	≤ 6.1 mΩ	IEC 60512-2
Max. working frequency	500 MHz	For coaxial type	

**Note:**

- <sup>4)</sup> after 5000 mating cycles and the salt spray test according to IEC 60512-6 test 11 f.
- <sup>5)</sup> for chrome plated product («C» material code).

## FVN Straight plug, cable collet

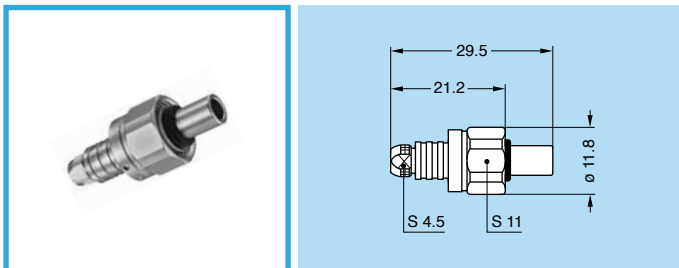

Part number	Cable group
<b>FVN.03.250.CLAC27</b>	4
<b>FVN.03.250.SLAC27</b>	4
<b>FVN.03.250.CLAC31</b>	3
<b>FVN.03.250.SLAC31</b>	3

Cable assembly (page 12)



### FVN Straight plug, cable collet and nut for fitting a bend relief

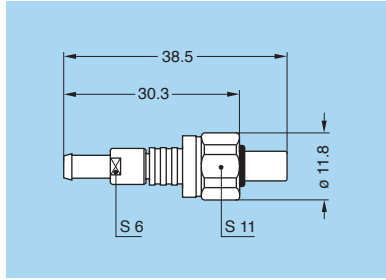

Part number	Cable group
<b>FVN.03.250.CLAC27Z</b>	4
<b>FVN.03.250.SLAC27Z</b>	4
<b>FVN.03.250.CLAC31Z</b>	3
<b>FVN.03.250.SLAC31Z</b>	3

Cable assembly (page 12)  
**Note:** The bend relief must be ordered separately (page 11).

### FVS Straight plug for cable crimping

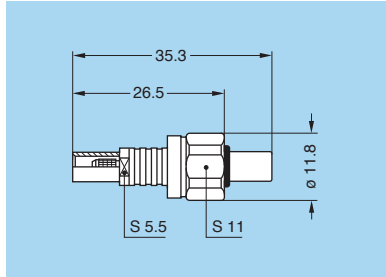

Part number	Cable group
<b>FVS.03.250.CLAE24</b>	1
<b>FVS.03.250.CLCE24</b>	1
<b>FVS.03.250.CLCE31</b>	3-4

Cable assembly (page 12)

### FVR Straight plug with brazing ferrule

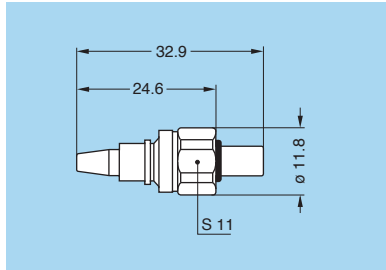

Part number	Cable $\varnothing$ (mm)
	max.
<b>FVR.03.250.SLAV16B</b>	1.55
<b>FVR.03.250.SLAV20B</b>	1.95

Cable assembly (page 12)

**Note:** The shell of the connector is in stainless steel AISI 316L.

### PVN Free socket and cable collet

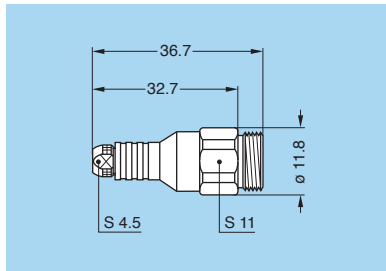

Part number	Cable group
<b>PVN.03.250.CLLC27</b>	4
<b>PVN.03.250.CLLC31</b>	3

Cable assembly (page 12)

**Note:** Also available with nut for fitting a bend relief (page 11).

## Vacuumtight models (coaxial type)

These sockets models allow the device on which they are fitted to reach a protection index of IP68 as per IEC 60529. They are fully compatible with plugs of the same series and are widely used for portable radios, military, laboratory equipment, aviation, etc.

These models are identified by a letter «P» or «S» at the last but one character of the reference. The Stycast® sealant can be used over a larger temperature range than the Araldite® sealant.

All these models are available in a watertight or vacuumtight version. Vacuumtight models are identified by an additional letter «V» at the end of the part number (certificate on request). Epoxy resin is used to seal these models.

### Technical Characteristics

#### Mechanical and Climatrical

Characteristics	Value	Standard
Endurance	> 1000 cycles	IEC 60512-5 test 9a
Humidity	up to 95% at 60° C	
Temperature range	-20° C, +100° C	
Salt spray corrosion test <sup>3)</sup>	> 1000 h	IEC 60512-6 test 11f

Characteristics	Value	Standard
Climatrical category	20/80/21	IEC 60068-1
Leakage rate (He) <sup>1)</sup>	< 10 <sup>-7</sup> mbar.l.s <sup>-1</sup>	IEC 60512-7 test 14b
Max. operating pressure <sup>2)</sup>	60 bars	IEC 60512-7 test 14d

**Note:**

<sup>1)</sup> only for vacuumtight models.

<sup>2)</sup> this value corresponds to the maximum allowed pressure difference for the assembled socket.

<sup>3)</sup> for chrome plated product («C» material code).

#### HVR Fixed socket, hexagonal flange, nut fixing, vacuumtight

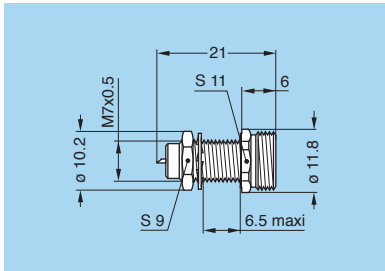

Part number	Sealing resin
<b>HVR.03.250.CLLPV</b>	Araldite®
<b>HVR.03.250.SLLPV</b>	Araldite®
<b>HVR.03.250.CLLSV</b>	Stycast®
<b>HVR.03.250.SLLSV</b>	Stycast®

Panel cut-out (page 11)

#### HVP Fixed socket, round flange, nut fixing, vacuumtight

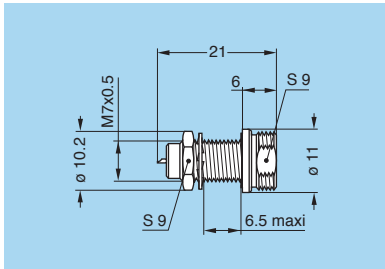

Part number	Sealing resin
<b>HVP.03.250.CLLPV</b>	Araldite®
<b>HVP.03.250.CLLSV</b>	Stycast®

Panel cut-out (page 11)

#### HVL Free socket, for device overmolding

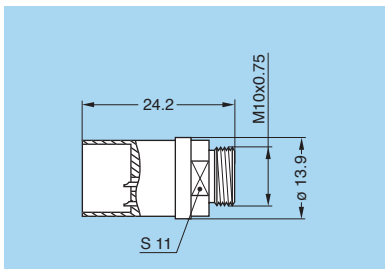

Part number
<b>HVL.03.250.NLL</b>

## HVV Free socket, for device overmolding, large shell

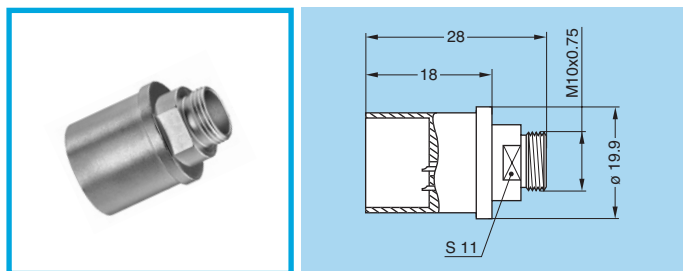

Part number  
**HVV.03.250.NLL**

**Note:** Vacuumtightness is achieved after customer overmolding.



## Alignment Key

### Alignment Key and Polarized Keying System for Multipole Types

03 series connector model part numbers are composed of three letters. The LAST LETTER indicates the key position and the contact type (male or female).

Front view of a socket 	Key	Nb of keys	Angles	Series	Contact type	
				03	Plug	Socket
	<b>G</b>	1		0°	male	female
	<b>B</b>	2	$\alpha$	60°	male	female



## Insert configuration

### Coaxial, multipole

			Reference	Series	Contact $\phi$ (mm)	Cable group	AWG max.	Impedance ( $\Omega$ )	Test voltage (kV rms) <sup>1)</sup> Contact-contact	Test voltage (kV rms) <sup>1)</sup> Contact-shell	Rated current (A) <sup>1)</sup>
<b>1</b>	Coaxial 		<b>250</b>	03	0.7	1-3-4	–	50	2.1	2.10	4.0
<b>2</b>	Multipole 		<b>302</b>	03	0.5	–	30	–	1.0	0.95	5.0
<b>3</b>	Multipole 		<b>303</b>	03	0.5	–	30	–	0.8	0.95	3.0
<b>4</b>	Multipole 		<b>304</b>	03	0.5	–	30	–	0.8	0.95	2.0
<b>6</b>	Multipole 		<b>306</b>	03	0.35	–	30	–	0.7	0.95	1.7

**Note:** <sup>1)</sup> Test voltage measured according to IEC 60512-2 test 4a standard.

## Housings

Ref.	Outer shell and collet nut		Latch sleeve + earthing crown		Other metallic components		Remarks	Note
	Material	Surf. treatment	Material	Surf. treatment	Material	Surf. treatment		
<b>C</b>	Brass	chrome	brass/bronze	nickel	brass	nickel	For multipole and coaxial	●
<b>S</b>	Stainless steel	–	brass/bronze	nickel	brass	nickel	For multipole and coaxial	○

**Note:** detailed characteristics of these materials and treatments are presented in the Unipole-Multipole catalogue.

- First choice alternative
- Special order alternative

## Contacts

Ref.	Contact type	Remarks
<b>A</b>	Male solder	For multipole and coaxial
<b>C</b>	Male crimp	For coaxial
<b>L</b>	Female solder	For multipole or coaxial type sockets

## Variant

### Bend relief for models with collet

Ref.	Collet		Need to be ordered separately	Dim. (mm)	
	Type	Code		Cable ø	
				max.	min.
<b>03</b> <b>Z</b>	C	27	GMB.00.025.DG	2.8	2.5
	C	31	GMB.00.028.DG	3.1	2.8
	C	27	GMD.00.025.DG	2.8	2.5
	C	31	GMD.00.028.DG	3.1	2.8
<b>Z</b>	K	35	GMA.0B.030.DG	3.4	3.0
	K	40	GMA.0B.035.DG	3.9	3.5
	K	45	GMA.0B.040.DG	4.4	4.0
	K	50	GMA.0B.045.DG	5.2	4.5

**Note:** The «GMD» are thin bend reliefs (for very flexible cables). The last letter «G» of the part number indicates the grey colour of the bend relief.

## Accessories

For accessories and tooling, please contact us.

## Tooling

### DCG Spanner for hexagonal nut

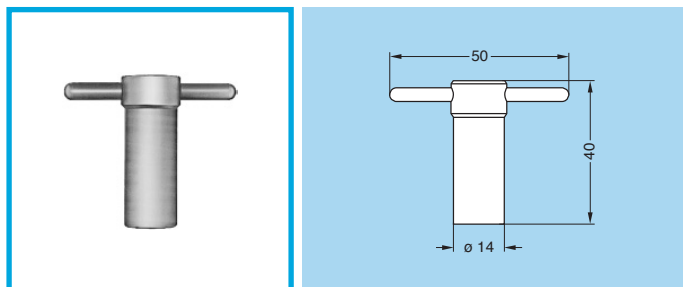

Part number	Part number of the nut
<b>DCG.91.149.0TN</b>	GEA.00.240.LN

● Material: Blackened steel

### DCP Flat spanners for collet nut

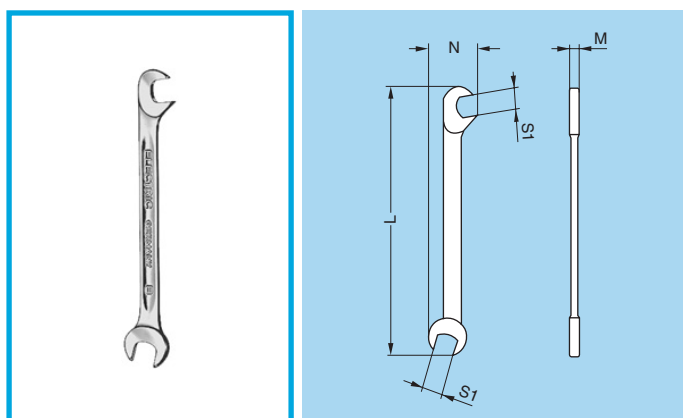

Part number	Dimensions			
	L	M	N	S1
<b>DCP.99.045.TC</b>	70	2	10.5	4.5
<b>DCP.99.050.TC</b>	78	2	12.6	5.0
<b>DCP.99.055.TC</b>	78	2	12.6	5.5
<b>DCP.99.060.TC</b>	78	2	12.6	6.0

● Material: Chrome-plated steel

### DPE Crimping tool with die (coaxial connectors)



Part number	Cable group
<b>DPE.99.123.1K</b>	1
<b>DPE.99.123.8K</b>	2-3-4

### DPN Dies

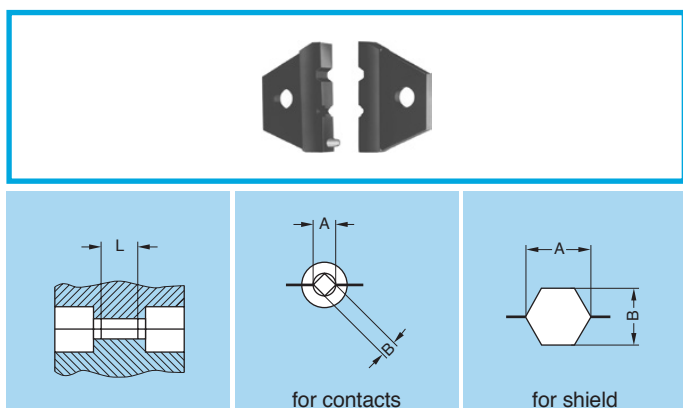

Part number	Cable group	Die dimension				
		For contacts			For shield	
		A	B	L	A	B
<b>DPN.99.123.1K</b>	1	1.29	0.91	2.0	3.10	2.70
<b>DPN.99.123.8K</b>	2-3-4	1.29	0.91	2.0	3.80	3.30

● Dies material: Blackened steel



## Panel cut-outs

### Panel Cut-outs

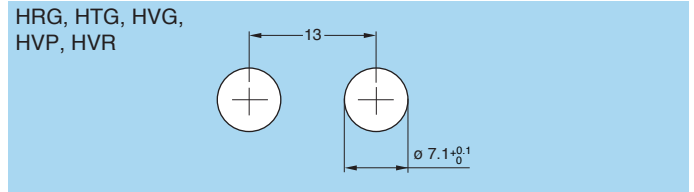
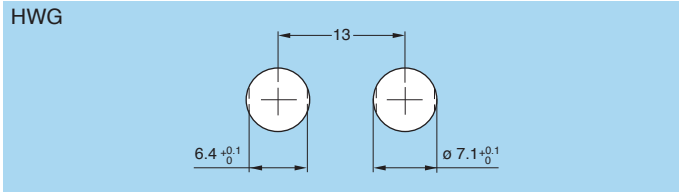

### Mounting nuts torque

Component	Torque (Nm)
Retaining nut	0.25
Hexagonal nut	2.00
Coupling nut	2.00

1N = 0.102 kg

## Cable assembly

### Assembly instructions

In order to ensure the sealing of plugs and sockets on the cable side, it is imperatively necessary to complete their assembly by realizing it with an adapted technique.

We recommend the fitting of an heatshrink boot with inner melting coating of type ATUM (manufactured by the RAYCHEM company) or similar.

**This heatshrink boot is not provided with the connector. Please consult us.**

### Cable stripping lengths

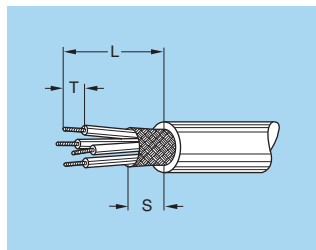

Connector		Ø contact A (mm)	Cable stripping lengths (mm)		
Series	Type		L	S	T
03	250	0.7	6	2.5	3
	302/303/304	0.5	6	2.5	3
	302/303/304 <sup>1)</sup>	0.5	13.5	–	2.5

**Note:** the tolerances on these dimensions are:  
 L: ± 0.5 mm; S: ± 0.5 mm; T: ± 0.2 mm.  
<sup>1)</sup> for FVG model with cable crimping.

## Recommended coaxial cables

### Recommended cables for coaxial types

Cable group	Standard			Reference	Imp. (Ω)
	MIL-C-17	IEC 96-2	CCTU 10-01A		
3	RG.174 A/U	50.2.1	KX 3A	CCX.50.RG1.74AU27N	50 ± 2 Ω
			KX 38	CCX.50.RG1.74U25N	
1	RG.178 B/U	50.1.1	KX 21A	CCX.50.RG1.78BU18M	50 ± 2 Ω
4	RG.188 A/U	50.2.3		CCX.50.RG1.88AU24B	50 ± 2 Ω
1	RG.196 A/U	50.1.2		CCX.50.RG1.96AU20B	50 ± 2 Ω
4	RG.316 /U	50.2.2	KX 22A	CCX.50.RG3.16BU26M	50 ± 2 Ω

## Product safety notice

**PLEASE READ AND FOLLOW ALL INSTRUCTIONS CAREFULLY AND CONSULT ALL RELEVANT NATIONAL AND INTERNATIONAL SAFETY REGULATIONS FOR YOUR APPLICATION. IMPROPER HANDLING, CABLE ASSEMBLY, OR WRONG USE OF CONNECTORS CAN RESULT IN HAZARDOUS SITUATIONS.**

### 1. SHOCK AND FIRE HAZARD

Incorrect wiring, the use of damaged components, presence of foreign objects (such as metal debris), and / or residue (such as cleaning fluids), can result in short circuits, overheating, and / or risk of electric shock. Mated components should never be disconnected while live as this may result in an exposed electric arc and local overheating, resulting in possible damage to components.

### 2. HANDLING

Connectors and their components should be visually inspected for damage prior to installation and assembly. Suspect components should be rejected or returned to the factory for verification.

Connector assembly and installation should only be carried out by properly trained personnel. Proper tools must be used during installation and / or assembly in order to obtain safe and reliable performance.

### 3. USE

Connectors with exposed contacts should never be live (or on the current supply side of a circuit). Under general conditions voltages above 30 VAC and 42 VDC are considered hazardous and proper measures should be taken to eliminate all risk of transmission of such voltages to any exposed metal part of the connector.

### 4. TEST AND OPERATING VOLTAGES

The maximum admissible operating voltage depends upon the national or international standards in force for the application in question. Air and creepage distances impact the operating voltage; reference values are indicated in the catalog however these may be influenced by PC board design and / or wiring harnesses.

The test voltage indicated in the catalog is 75% of the mean breakdown voltage; the test is applied at 500 V/s and the test duration is 1 minute.

### 5. CE MARKING

CE marking  means that the appliance or equipment bearing it complies with the protection requirements of one or several European safety directives.

CE marking  applies to complete products or equipment, **but not to electromechanical components, such as connectors.**

### 6. PRODUCT IMPROVEMENTS

The LEMO Group reserves the right to modify and improve to our products or specifications without providing prior notification.

### 7. **WARNING (Prop 65 State of California)**

Proposition 65 requires businesses to provide warnings to Californians about significant exposures to chemicals that cause cancer, birth defects or other reproductive harm. LEMO products are exempt from proposition 65 warnings because they are manufactured, marketed, and sold solely for commercial and industrial use. For further information, please visit <https://www.lemo.com/quality/LEMO-Prop-65-compliance-declaration.pdf>.

## Disclaimers

LEMO works constantly to improve the quality of its products; the information and illustrations figuring in this document may therefore vary and are not binding. In any case, LEMO makes no specific warranty of merchantability, fitness for a particular purpose, third party components as such or included in assembly, non-infringement, title, accuracy, completeness, or security. The user is fully responsible for his products and applications using LEMO component.

In no event shall LEMO, its affiliates, officers, agents or employees be liable for any incidental, indirect, special or consequential damages in connection with the products or services provided by LEMO, including (without limitation) loss of profits or revenues, interruption of business, loss of use of the products or any associated equipment, materials, components or products, damages to associated equipment or in combination with other components, materials.

Reproduction of significant portions of LEMO information in LEMO data books or data sheets is permissible only if reproduction is without alteration and is accompanied by all associated warranties, conditions, limitations, and notices. LEMO is not responsible or liable for such altered documentation. Information of third parties may be subject to additional restrictions.

## LEMO HEADQUARTERS

### SWITZERLAND

#### LEMO SA

Chemin des Champs-Courbes 28 - P.O. Box 194 - CH-1024 Ecublens  
Tel. +41 21 695 16 00 - e-mail: info@lemo.com

## LEMO SUBSIDIARIES

### AUSTRIA

#### LEMO Elektronik GesmbH

Lemböckgasse 49/E6-3

1230 Wien

Tel: +43 1 914 23 20 0

Fax: +43 1 914 23 20 11

salesAT@lemo.com

### BRAZIL

#### LEMO Latin America Ltda

Av. Dr. Adhemar de Barros,

566 - Sala 1407, Vila Adyana

CEP: 12245-011

São José dos Campos - SP - Brazil

Tel: +55 11 94242 4293

info-la@lemo.com

### CANADA

#### LEMO Canada Inc

44 East Beaver Creek Road, unit 20

Richmond Hill, Ontario L4B 1G8

Tel: +1 905 889 56 78

Fax: +1 905 889 49 70

info-canada@lemo.com

### CHINA / HONG KONG

#### LEMO Electronics (Shanghai) Co., Ltd

First Floor, Block E,

18 Jindian Road, Pudong

Shanghai, China, 201206

Tel: +86 21 5899 7721

Fax: +86 21 5899 7727

cn.sales@lemo.com

### DENMARK

#### LEMO Denmark A/S

Mandal Allé 16A

5500 Middelfart

Tel: +45 45 20 44 00

Fax: +45 45 20 44 01

info-dk@lemo.com

### FRANCE

#### LEMO France Sàrl

24/28 Avenue Graham Bell

Bâtiment Balthus 4

Bussy Saint Georges

77607 Marne la Vallée Cedex 3

Tel: +33 1 60 94 60 94

Fax: +33 1 60 94 60 90

info-fr@lemo.com

### GERMANY

#### LEMO Elektronik GmbH

Hanns-Schwindt-Str. 6

81829 München

Tel: +49 89 42 77 03

Fax: +49 89 420 21 92

info@lemo.de

### HUNGARY

#### REDEL Elektronika Kft

Nagysándor József u. 6-12

1201 Budapest

Tel: +36 1 421 47 10

Fax: +36 1 421 47 57

info-hu@lemo.com

### ITALY

#### LEMO Italia srl

Viale Lunigiana 25

20125 Milano

Tel: +39 02 66 71 10 46

Fax: +39 02 37 90 80 46

sales.it@lemo.com

### JAPAN

#### LEMO Japan Ltd

2-7-22, Mita,

Minato-ku, Tokyo, 108-0073

Tel: +81 3 54 46 55 10

Fax: +81 3 54 46 55 11

info-jp@lemo.com

### NETHERLANDS / BELGIUM

#### LEMO Connectors Nederland B.V.

Jacques Meuwissenweg 6

2031 AD Haarlem

Tel. +31 23 206 07 01

info-nl@lemo.com

### NORWAY / ICELAND

#### LEMO Norway A/S

Soerumsandvegen 69,

1920 Soerumsand

Tel: +47 22 91 70 40

Fax: +47 22 91 70 41

info-no@lemo.com

### SINGAPORE

#### LEMO Asia Pte Ltd

4 Leng Kee Road,

#06-09 SiS Building

Singapore 159088

Tel: +65 6476 0672

Fax: +65 6474 0672

sg.sales@lemo.com

### SPAIN / PORTUGAL

#### IBERLEMO SAU

Brasil, 45, 08402 Granollers

Barcelona

Tel: +34 93 860 44 20

Fax: +34 93 879 10 77

info-es@lemo.com

### SWEDEN / FINLAND

#### LEMO Nordic AB

Gunnabogatan 30, Box 8201

163 08 Spånga

Tel: +46 8 635 60 60

Fax: +46 8 635 60 61

info-se@lemo.com

### SWITZERLAND

#### LEMO Verkauf AG

Grundstrasse 22 B,

6343 Rotkreuz

Tel: +41 41 790 49 40

ch.sales@lemo.com

### TAIWAN

#### TAOYUAN TAIWAN

Tel: +886 967 132 824

speng@lemo.com

### UNITED ARAB EMIRATES

#### LEMO Middle East Connectors LLC

Concorde Tower 6th Floor,

Dubai Media City, P.O. Box 126732

Dubai, United Arab Emirates

Tel: +971 55 222 36 77

info-me@lemo.com

### UNITED KINGDOM

#### LEMO UK Ltd

12-20 North Street, Worthing,

West Sussex, BN11 1DU

Tel: +44 1903 23 45 43

lemouk@lemo.com

### USA

#### LEMO USA Inc

P.O. Box 2408

Rohnert Park, CA 94927-2408

Tel: +1 707 578 88 11

+1 800 444 53 66

Fax: +1 707 578 08 69

info-US@lemo.com

## LEMO DISTRIBUTORS

ARGENTINA, AUSTRALIA, BRAZIL, CHILE, COLOMBIA, CZECH REPUBLIC,  
GREECE, INDIA, ISRAEL, NEW ZEALAND, PERU, POLAND, RUSSIA,  
SOUTH AFRICA, SOUTH KOREA, TURKEY, UKRAINE

[www.lemo.com](http://www.lemo.com)