

Contact Information

545-Wire Wrap, High Point - Tail LG = .560(14.22)

.100" (2.54mm) Contact Spacing x .200" (5.08mm) Row Spacing

THIS IS A C.A.D. GENERATED DRAWING
DO NOT MAKE MANUAL REVISIONS TO MASTER.



ISSUE NUMBER

ORIGINAL ①

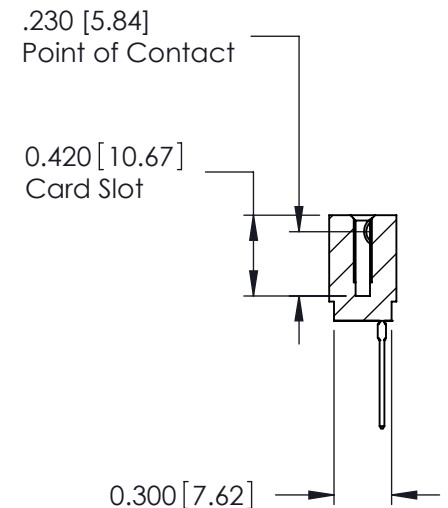
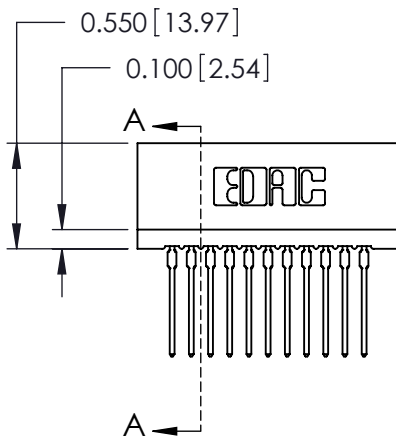
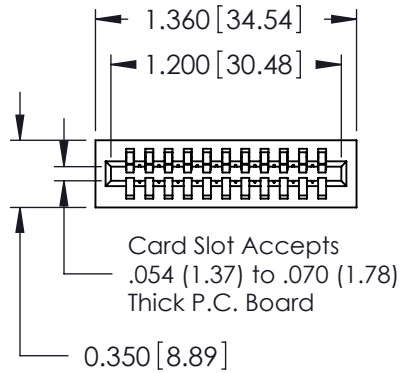

725 Series Ultra-Mate Card Edge Connector - Press Fit

Part Number: 725-011-545-101

ACAD REFERENCE NO. 725-ENG MASTER

DRAWN: J.LEE DATE: 2008/03/09

CHECKED: DATE:

SCALE: SHEET 1 OF 1

DRAWING NUMBER ISSUE

725-ENG MASTER 1



EDAC INC
TORONTO, ONTARIO
CANADA

YOUR CONNECTION TO QUALITY & SERVICE

THESE DRAWINGS AND SPECIFICATIONS
ARE THE PROPERTY OF EDAC INC. AND
SHALL NOT BE REPRODUCED, OR COPIED
OR USED AS THE BASIS FOR THE
MANUFACTURE OR SALE OF APPARATUS
WITHOUT WRITTEN PERMISSION.