

5 V/20 A, active clamp forward converter, Power Over Ethernet (PoE) - IEEE 802.3bt compliant reference design

Introduction

This reference design represents a PoE Class 8 converter designed for high efficiency conversion over a wide load range. It is based on the [PM8805](#) PoE-PD interface compliant with the IEEE802.3bt standard, and a DC-DC forward active clamp converter driven by the [PM8804](#) PWM controller.

The [PM8805](#) system on package device embeds two active bridges and an IEEE802.3bt compliant Powered Device (PD) interface. It can be used in all medium-to-high power 2P and 4P high efficiency PoE and PoE+ applications such as point of sales and retail logistics devices.

The [PM8804](#) PWM controller represents an integrated solution for a smart and efficient 48 V converter, including a programmable oscillator for the switching frequency, adjustable slope compensation, dual complementary low-side drivers with programmable dead time, programmable soft start, soft turn off and a programmable current sense blanking time.

Figure 1. STEVAL-POE003V1 reference design

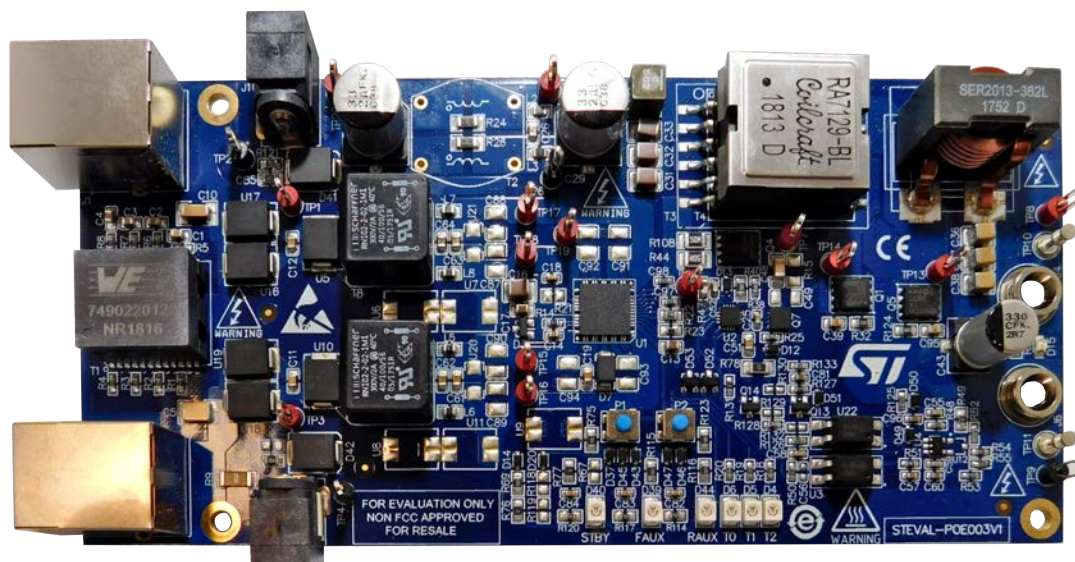

1 STEVAL-POE003V1 reference design overview

1.1 Specifications, connectors and LEDs

Table 1. STEVAL-POE003V1 specifications

Parameter	Specs
V_{IN} at RJ45 connector	From 41.2 to 57 V
I_{IN} at RJ45 connector	1.0 A max. each pair
V_{OUT}	5 V \pm 2%
I_{OUT}	20 A total max. ⁽¹⁾
Max. output power	100 W ⁽²⁾
Efficiency overall peak	>92% at 13 A >90% at 20 A
V_{IN} at Frontal Jack connector (J9)	48 V \pm 2 V
I_{IN} at Frontal Jack connector (J9)	2.0 A total max.
V_{IN} at Rear Jack connector (J10)	48 V \pm 2 V
I_{IN} at Rear Jack connector (J10)	2.5 A total max.
Operating temperature	0°C - 50°C 20 A full load 50°C - 85°C linearly decrease to 13 A

1. There are two limits to play with: the power limits specified in the BT standard \rightarrow Class 8 means 71 W min. available at PD interface with the specified efficiency of about 13A at the output; the PM8805 current limit \rightarrow 2 amp min., about 2.5 A typical, that is, to reach 20 amp on the output the PoE input voltage must be of at least 56 V or an auxiliary rear input source must be capable of about 110 W. In fact, the max. power can be reached using the rear input, to bypass the PM8805 current limit circuit.
2. The max. power cannot be maintained at a high ambient temperature ($T_{amb} > 50^{\circ}\text{C}$) for a long time

Table 2. STEVAL-POE003V1 connectors

Reference	Type	Specs
J1	RJ45 connector	Data and power input
J2	RJ45 connector	Data output
J9	Power jack	Front Aux
J10	Power jack	Rear Aux
J4, TP10	Banana jack/turret	Positive of V_{OUT}
J6, TP11	Banana jack/turret	Negative of V_{OUT} (Sec GND)
TP8	Test point	Monitor of V_{OUT}
TP9	Test point	Monitor of Sec GND
P1	Push button	SLEEP/WKUP
P2	Push button	SHDN

Table 3. STEVAL-POE003V1 LEDs

Reference	Type	Function	Logic
D4	Green LED	Monitor of T2 signal	LED on when T2 is low
D5	Green LED	Monitor of T1 signal	LED on when T1 is low
D6	Green LED	Monitor of T0 signal	LED on when T0 is low
D15	Green LED	Monitor of V _{OUT}	LED on when V _{OUT} is present
D39	Green LED	Monitor of FAUX signal	LED on when frontal aux is present
D40	Green LED	Monitor of STBY signal	LED on when STBY is high
D44	Green LED	Monitor of RAUX signal	LED on when rear aux is present

Table 4. Tx signal possible configurations

Classification	T0	T1	T2	Bridges	Finger number	Notes
Type 1 (13 W)	1	1	1	1	0 or 1	Legacy type
Type 2 (25.5 W)	0	1	1	1	2, 3	Legacy type
Type 3 (51 W)	1	0	0	2	4	New PD type
Type 4 (71 W)	0	0	0	2	≥ 5	New PD type
Type 3 on 4 pairs (13 W), or legacy 4 pairs (type 1 class)	1	1	0	2	0 or 1	New PD type
Type 3 on 4 pairs (25.5 W), or legacy 4 pairs (type 2 class)	0	1	0	2	2, 3	New PD type
Rear AUX	0	0	1	any	N.A.	Aux present
Front AUX				0		

The [STEVAL-POE003V1](#) reference design is classified as type 4 and class 8. The default status of Tx signal is 000.

Note: Level 0 or low means the corresponding LED is on; level 1 or high means the LED is off.

1.2 Board setup

The [STEVAL-POE003V1](#) reference design combines the [PM8805](#) PD interface, compliant with the IEEE 802.3bt PoE standard, and the [PM8804](#) PWM controller for an active clamp forward.

Figure 2. STEVAL-POE003V1 reference design: components view

- 1. POE IN
- 2. RAUX IN
- 3. FAUX IN
- 4.SLEEP and WAKEUP
- 5.SHUTDOWN
- 6.OUTPUT

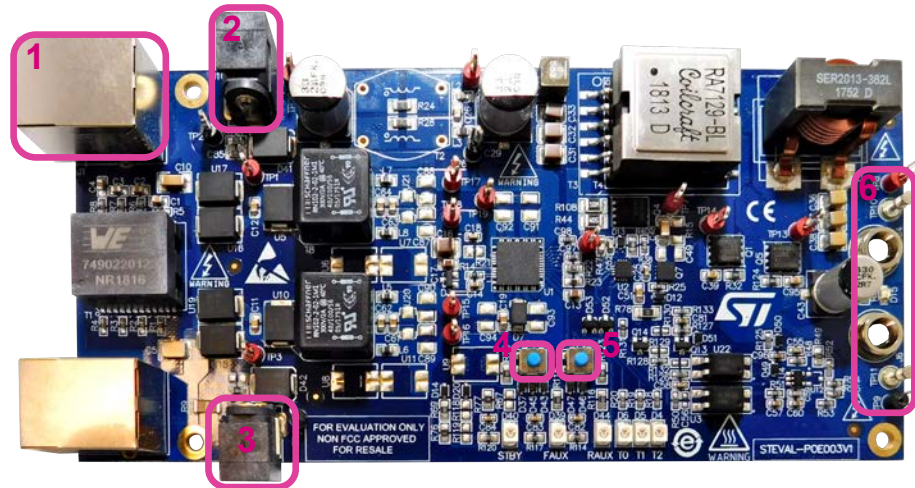

When you use a bench power supply, follow the steps below.

- Step 1.** Set the power supply current limit to 0.2 A
- Step 2.** Apply 10 V and check the input current is 350-400 μ A
- Step 3.** Apply 20 V and check the input current is within the selected Class range (the default is Class 8, 39 mA)
- Step 4.** Apply 48 V and check the input current is <60 mA and the output voltage is 5 V (without load)
- Step 5.** Change the current limit to 3 A
- Step 6.** Connect an electronic load between V_{OUT} and the secondary GND
- Step 7.** Turn the power supply on (48 V) and check the input current is coherent with the load current setting and the converter expected efficiency.
For example, $5\text{ V} \times 13\text{ A} = 65\text{ W}$ \rightarrow expected efficiency is 92% so $P_{IN} = 65/0.92=70.65\text{ W}$, which, with 48 V as input voltage, gives $I_{input} = 70.65/48 = 1.47\text{ A}$
- Step 8.** Change the load current as needed

2 Configurations

2.1 PM8805 configurations

Table 5. PM8805 control signal description

PM8805 behavior, standard operations	INPUTS			OUTPUTS				
	FAUX	RAUX	STBY	PGD	Hot swap	Charge pump	Active bridge	MPS
Normal POE operation	0	0	0	1 after 85ms hot swap enabled	Closes at UVLO	On @ UVLO	Enabled	Off
Stby PoE operation	0	0	1	1 when hot swap closed	Closes at UVLO	Off	LS enabled HS OFF	On
Front Aux operation	1	0	x	1 when hot swap closed	Closed	On	Enabled	Off
Rear Aux operation	0	1	0	1	Open	Off	Off	Off
Additional non standard operations								
Sleep mode/Wake up	1	1	1	0	Open	Off	LS enabled HS OFF	On
Rear Aux with MPS	0	1	1	1	Open	Off	LS enabled HS OFF	On
Shutdown/reboot	1	1	0	0	Open	Off	Off	Off

2.2 PoE

The [STEVAL-POE003V1](#) reference design default operation mode is the PoE (0,0,0). The selected class resistors are 36.5 ohm for CLS1 and 51.1 ohm for CLS2, so the board is class 8; that is, the Tx LED configuration is 000 or all LEDs on.

The other classes can be adjusted using the following table.

Table 6. PM8805 class description

PD class	CLS1 resistor (Ω)	CLS2 resistor (Ω)	Min. (mA)	Max. (mA)
Class 0	2 K	2 K	0	4.0
Class 1	150	150	9.0	12.0
Class 2	80.6	80.6	17.0	20.0
Class 3	51.1	51.1	26.0	30.0
Class 4	36.5	36.5	36.0	44.0
Class 5	36.5	2 K	36/0	44/4
Class 6	36.5	150	36/9	44/12
Class 7	36.5	80.6	36/17	44/20

PD class	CLS1 resistor (Ω)	CLS2 resistor (Ω)	Min. (mA)	Max. (mA)
Class 8	36.5	51.1	36/26	44/30

Classification phase is valid only for PoE devices, so it is not required when connected to any non-PoE power source such as a wall adapter: in those cases, the CLS buffers are never turned on.
 Depending on the PD type and class, the relevant PD electrical parameters are summarized in the table below.

Table 7. PM8805 PD main parameters

PD type	Class	CLS1 sign.	CLS2 sign.	Pin (W)	Vin min. (V)	Vin max. (V)	I _{IN} max. (mA)	P _{peak} (W) for 50 ms
1	0	0	0	13.0	37.0	57	350	14.4
	1	1	1	3.84	42.1		90	5.00
	2	2	2	6.49	40.8		160	8.36
	3	3	3	13.0	37.0		350	14.4
2	4	4	4	25.5	42.5		600	28.05
3	1	1	1	3.84	42.1		90	5.00
	2	2	2	6.49	40.8		160	8.36
	3	3	3	13.0	37.0		350	14.4
	4	4	4	25.5	42.5		600	28.05
	5	4	0	40.0	44.3		900	42
4	6	4	1	51.0	42.5	1200	53.55	
	7	4	2	62.0	42.9	1440	65.10	
	8	4	3	71.3	41.2	1730	74.86	

2.3 FAUX connector

A voltage applied at J9 connector (FAUX) sets automatically the correct input configuration (FAUX=1, RAUX=0, STBY=do not care).

If the [STEVAL-POE003V1](#) reference design is already powered by a PSE, the following conditions apply:

1. FAUX voltage lower than PSE voltage: the board is still powered from PSE and T0,T1,T2 signal configuration remains the same according to Table 4
2. FAUX voltage is greater than PSE voltage, but the difference is less than 2 V: a current sharing occurs between PSE and FAUX to supply the board. T0,T1,T2 signal configuration remains unchanged as in the previous case
3. FAUX voltage is greater than PSE voltage and the difference is greater than 2 V: the board is powered by FAUX, PSE is disconnected as its load has significantly decreased (~3 mA) and PD does not ensure MPS condition.

The [PM8805](#) device works in Front aux mode (T0=0,T1=0,T2=1). When the FAUX connector (J9) is unplugged, PSE is not connected and the output voltage is interrupted as a new detection/classification procedure must be done before PSE powers the board again.

2.4 RAUX with MPS

A voltage applied at J10 connector (RAUX) sets automatically the correct input configuration (FAUX=0; RAUX=1; Stby=1).

The hot swap MOSFET is opened to give prevalence of the RAUX source over the PoE interface.

The [STEVAL-POE003V1](#) reference design is configured to put the PSE in MPS mode triggering the STBY pin threshold by a proper divider (R69, R76 and R120) supplied by the RAUX input voltage. When STBY pin is pulled up, MPS current is enabled and drawn from the PSE.

The RAUX voltage can be in one of the following ranges, depending on the PSE voltage available at RJ45 connector (J1):

- RAUX voltage lower than PSE input voltage of less than 8 V: when RAUX voltage is applied and the board is already powered by PSE, switching between the two power supply sources works properly. The PM8805 device goes in Rear auxiliary with MPS mode and PSE remains connected to the board (T0=0, T1=0, T2=1)

Figure 3. PSE to RAUX switchover at VPSE=55 V, VRAUX=48 V, IO_{UT}=13 A

- Ch1: VDC input voltage (TP5); Ch2: PSE input current (J1 twisted pairs)
- Ch3: RAUX signal (pin 11 U1 - PM8805); Ch4: RAUX input current (J10)



When RAUX power supply is unplugged from J10, PSE is immediately available to supply the board, without causing output voltage interruptions, and the PM8805 device goes back to normal operating mode.

As shown in the figure below, there is a delay of about 200 μs between the time the RAUX source is unplugged and the hot swap MOSFET of PM8805 is turned on again, during which the forward converter is supplied only by input capacitors C29 and C15.

Figure 4. RAUX to PSE switchover at $I_{OUT}=13\text{ A}$, $V_{RAUX}=48\text{ V}$, PSE voltage=55 V

- Ch1: VDC input voltage (TP5); Ch2: PSE input current (J1 twisted pairs)
- Ch3: Vout output voltage (TP8); Ch4: RAUX signal (pin 11 U1 - PM8805)



- RAUX voltage lower than PSE input voltage of more than 8 V: when RAUX voltage is applied and the board is already powered by PSE, switching between the two power supply sources works properly as in the previous case. When RAUX power supply is unplugged from J10, during the switchover, the following failures of the PM8805 hot swap MOSFET might occur:
 - hot swap MOSFET drop between drain and source is greater than the datasheet parameter **Vds_fail** (12 V min./16 V max.)
 - hot swap MOSFET current is greater than the datasheet parameter **Short** (4 A min./6 A max.)

If one of these failures occurs, the power good signal is forced to low level according to the datasheet parameter **Tretry** (9 min./11 max. msec), stopping the forward converter switching, then it is released causing a switching converter restart as shown in the following figure.

Figure 5. RAUX to PSE switchover at $I_{OUT}=13\text{ A}$

- Ch1: VDC input voltage (TP5); Ch2: Vout output voltage (TP8)
- Ch3: RAUX signal (pin 11 U1-PM8805); Ch4: PGD signal (TP19)



- RAUX voltage is greater than PSE input voltage of at least a diode forward voltage: when RAUX voltage is applied and the board is already powered by PSE, switching between the two power supply sources works properly as reported in the previous cases, but in this condition MPS current is drawn by RAUX source, then PSE is no more able to stay connected to the board. In this case, when RAUX source is removed, the output voltage goes to zero until PSE has successfully completed detection and classification phases, and the voltage is reapplied to the PD interface.

2.5 Soft stop

An important feature of the [PM8804](#) is the soft stop that can be controlled via the MODE pin, used to select the converter operation mode.

By connecting this pin to AGND, you can turn GATE2 off when not used and disable the soft stop feature.

Pull up MODE pin if GATE2 is used and soft stop desired. Leave this pin open when not used.

In case of normal shutdown or thermal fault, the device features a soft stop procedure which helps to reduce the stress and the overvoltage on the power MOSFET and it is achieved discharging slowly the soft start capacitor with a $10\ \mu\text{A}$ current sink. On the [STEVAL-POE003V1](#) reference design the MODE pin is left open, as GATE2 must be available to implement the active clamp forward converter and, during normal shutdown, the soft stop procedure is implemented.

3 Measurements

3.1 Efficiency

The **STEVAL-POE003V1** reference design is composed by a PoE interface compliant with the last standard IEEE802.3bt, with the **PM8805** interface and a forward active clamp DC-DC converter that receives DC voltage from the PoE interface.

The figure below shows the efficiency of a single forward converter and the overall efficiency which also includes the PoE interface power losses.

Figure 6. STEVAL-POE003V1 overall and DC-DC efficiency

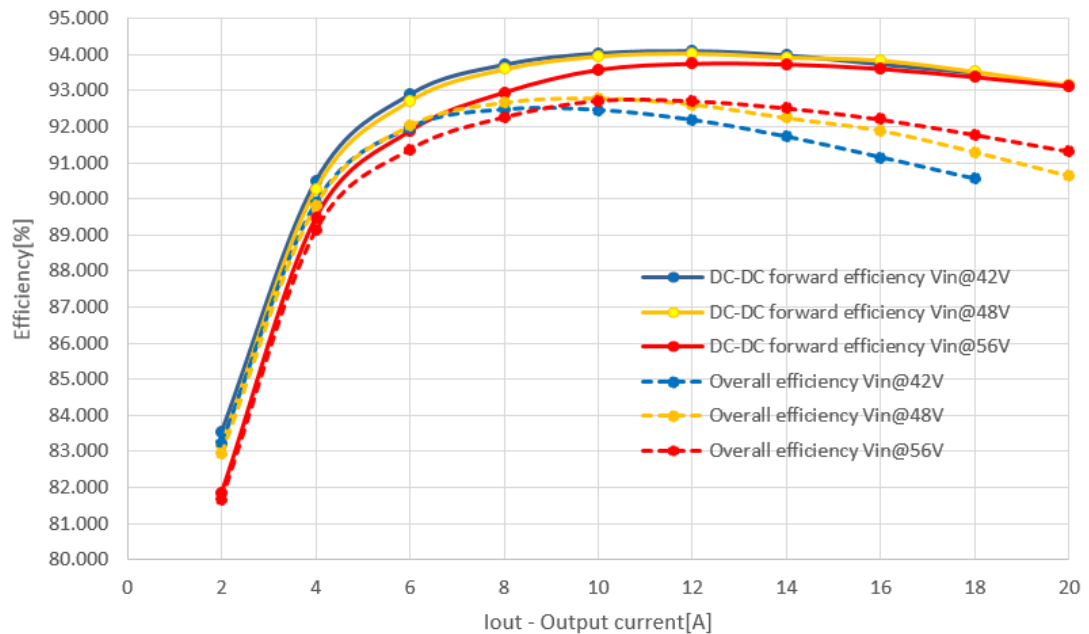

The dotted lines indicate the STEVAL-POE003V1 efficiency at different DC input voltages applied to RJ45 connector J1. The continuous line indicates the DC-DC forward efficiency, that does not include the following losses of the associated POE interface section:

- RJ45 connector J1
- PoE data transformer T1
- common chokes T7 and T8 placed on the two power supply pairs
- PM8805 interface that integrates the dual power MOS bridges and a hot swap MOSFET
- Forward converter input filter

This efficiency is measured between output test points TP8/TP9 and input test points TP5/TP6 of the forward converter.

3.2 Output voltage ripple

Figure 7. Output voltage ripple: $I_{OUT} = 2\text{ A}$

- Ch1: Vout ripple; Ch2: Primary MOSFET gate voltage; Ch3: I_{OUT}

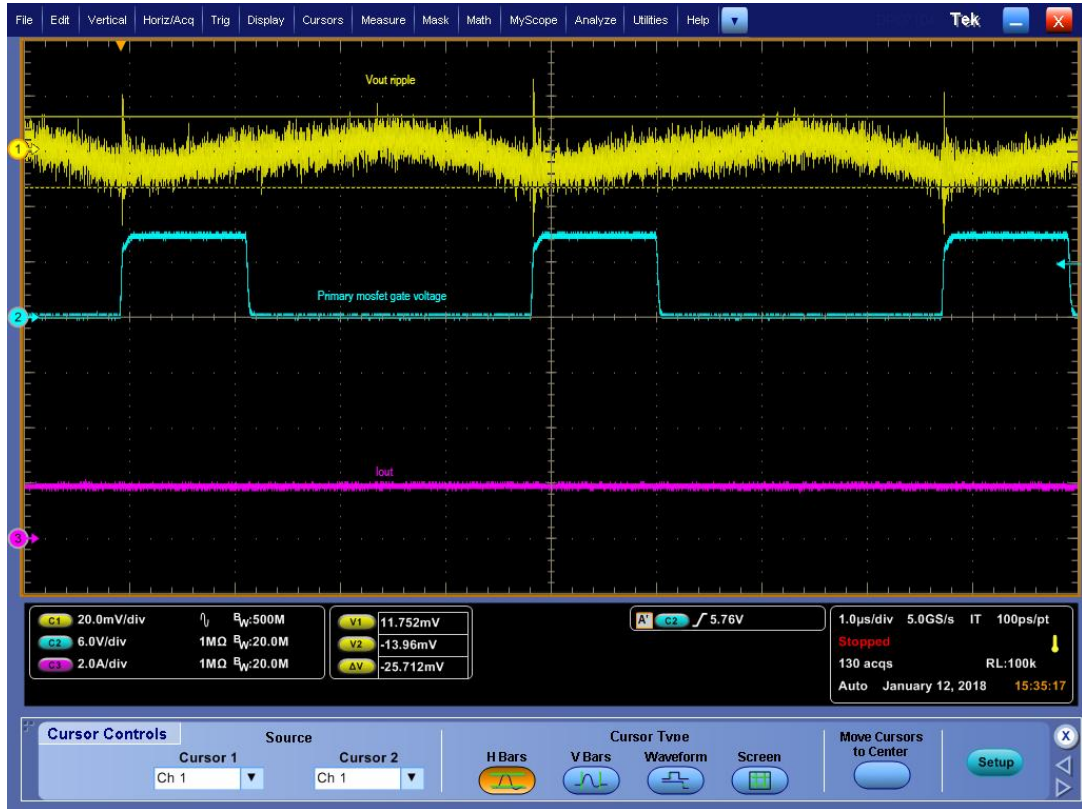
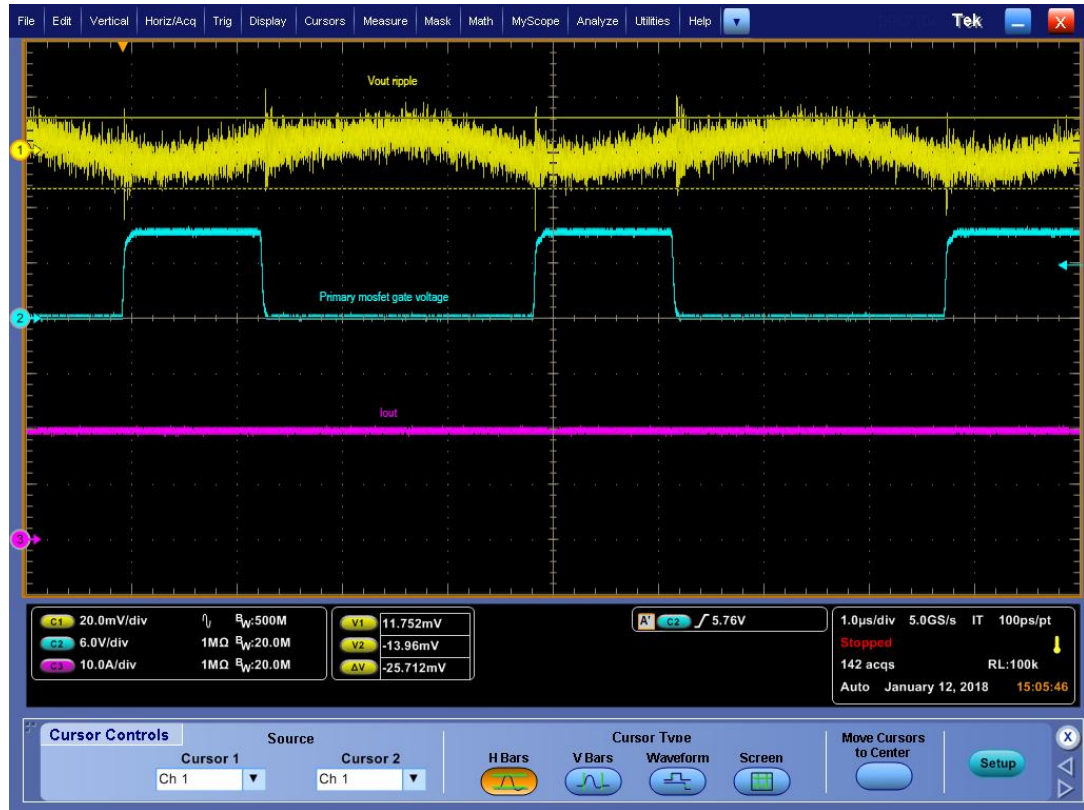

Figure 8. Output voltage ripple: $I_{OUT} = 20\text{ A}$

- Ch1: Vout ripple; Ch2: Primary MOSFET gate voltage; Ch3: I_{OUT}



3.3 Input voltage ripple

Figure 9. Input voltage ripple before and after forward input filter: input voltage=48 A, $I_{OUT}=2$ A

- Ch1: Vin ripple before input filter (TP5); Ch2: Primary MOSFET gate voltage
- Ch4: Vin ripple after input filter (C33); Ch3: Input current (J1 connector pairs)

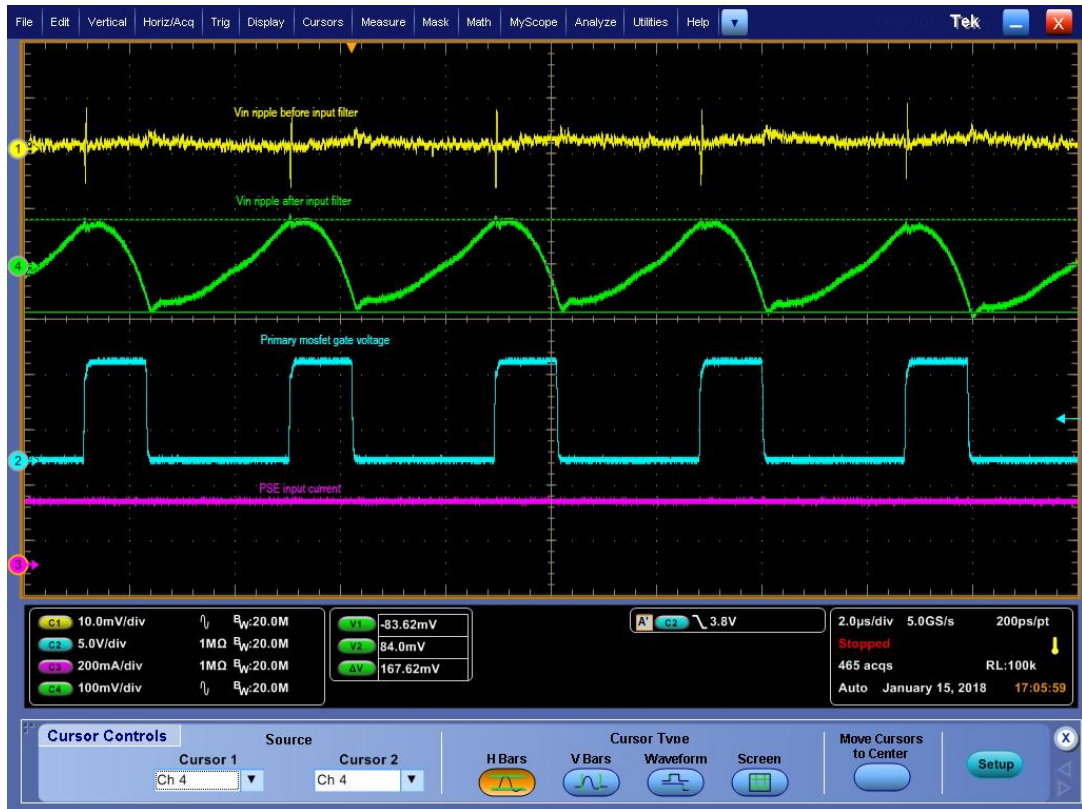
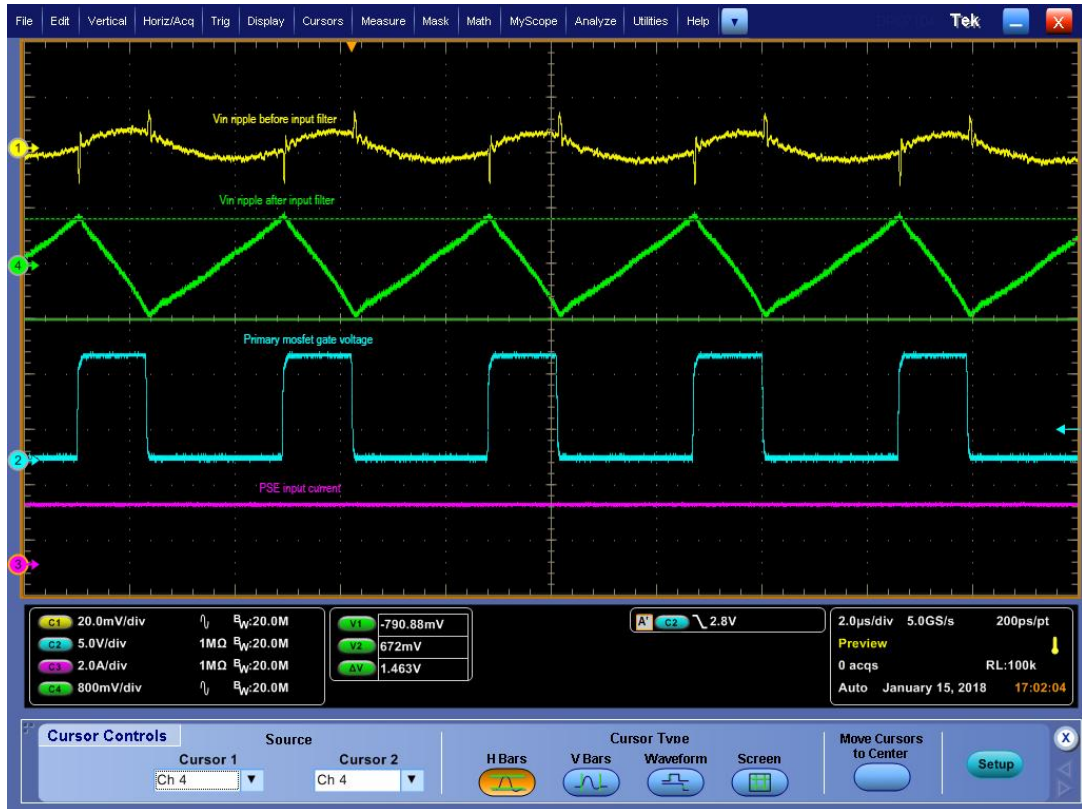

Figure 10. Input voltage ripple before and after forward input filter: input voltage=48 A, $I_{OUT}=20$ A

- Ch1: Vin ripple before input filter (TP5); Ch2: Primary MOSFET gate voltage
- Ch4: Vin ripple after input filter (C33); Ch3: Input current (J1 connector pairs)



3.4 Startup

Figure 11. Output voltage at startup: I_{out} at no load, V_{in}= 48 V

- Ch1: V_{out}; Ch2: Soft start voltage (C53); Ch4: primary MOSFET gate voltage



Figure 12. Output voltage at startup: $I_{out}=20\text{ A}$, $V_{in}=48\text{ V}$

- Ch1: Output voltage; Ch2: Soft start voltage (C53);
Ch3: Output current; Ch4: primary MOSFET gate voltage

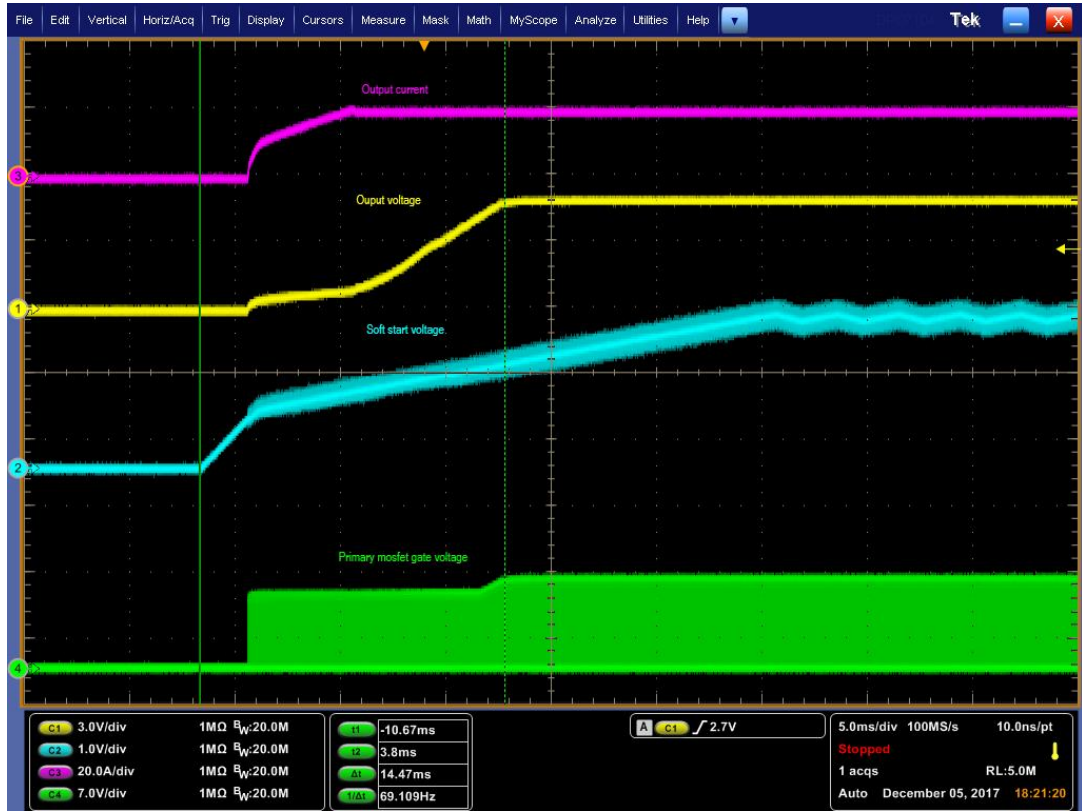

3.5 PoE connector unplugged power off

Figure 13. Power off at primary side: $I_{out}=18\text{ A}$, $V_{in}=42\text{ V}$

- Ch1: Primary Q4 MOSFET drain voltage; Ch2: Forward input voltage (TP5)
- Ch3: Soft start voltage (C53); Ch4: Power good (TP19)



Figure 14. Power off at secondary side (Q1): I_{out}=18 A, V_{in}= 42 V

- Ch1: Primary Q4 MOSFET drain voltage; Ch2: Secondary Q1 MOSFET gate voltage
- Ch3: Secondary Q1 MOSFET drain voltage; Ch4: Power good (TP19)

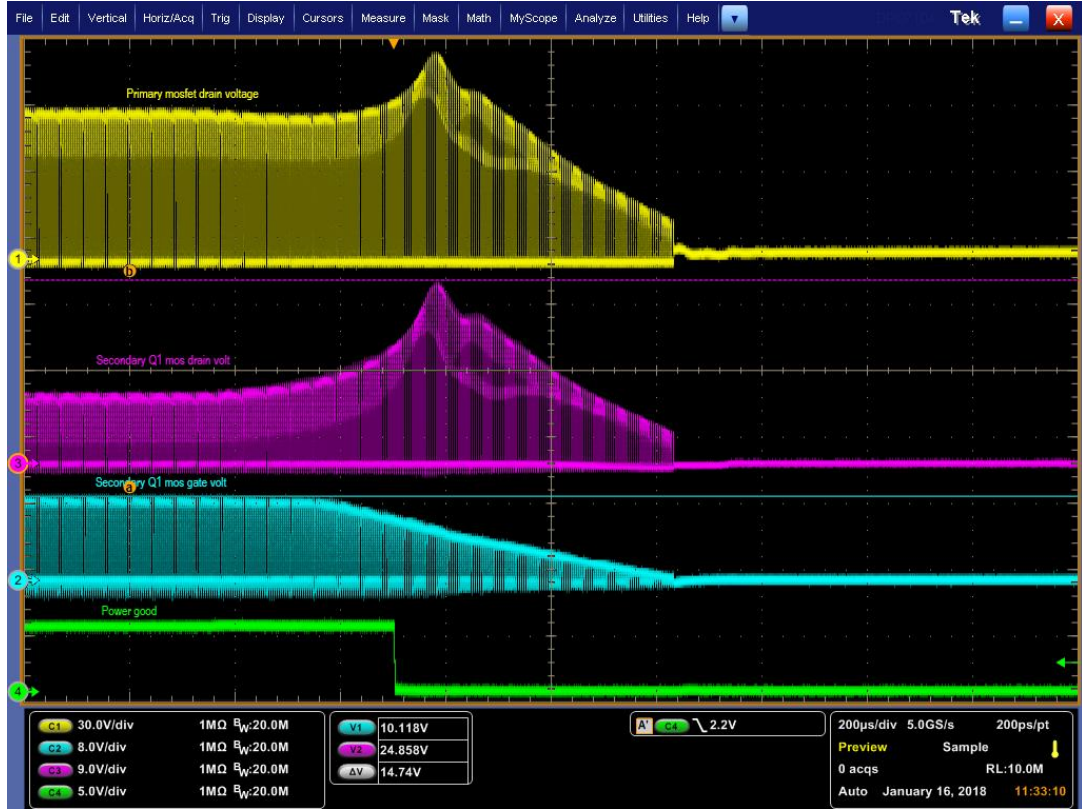
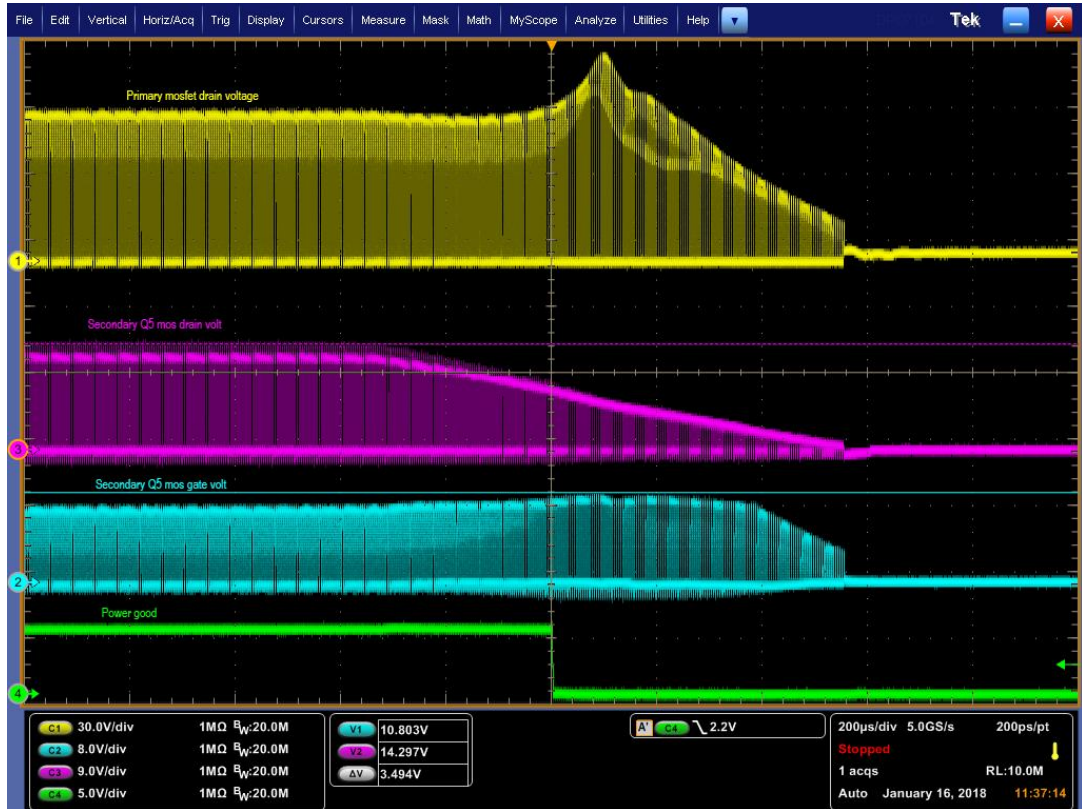

Figure 15. Power off at secondary side (Q5): I_{out}=18 A, V_{in}= 42 V

- Ch1: Primary Q4 MOSFET drain voltage; Ch2: Secondary Q5 MOSFET gate voltage
- Ch3: Secondary Q5 MOSFET drain voltage; Ch4: Power good (TP19)



3.6 Primary side waveforms

Figure 16. Primary steady state: $I_{out}=2\text{ A}$, $V_{in}=48\text{ V}$

- Ch1: Primary Q4 MOSFET drain voltage; Ch2: Primary current sense voltage
- Ch4: Primary MOSFET gate voltage



Figure 17. Primary steady state: $I_{out}=20\text{ A}$, $V_{in}=48\text{ V}$

- Ch1: Primary Q4 MOSFET drain voltage; Ch2: Primary current sense voltage
- Ch4: Primary MOSFET gate voltage

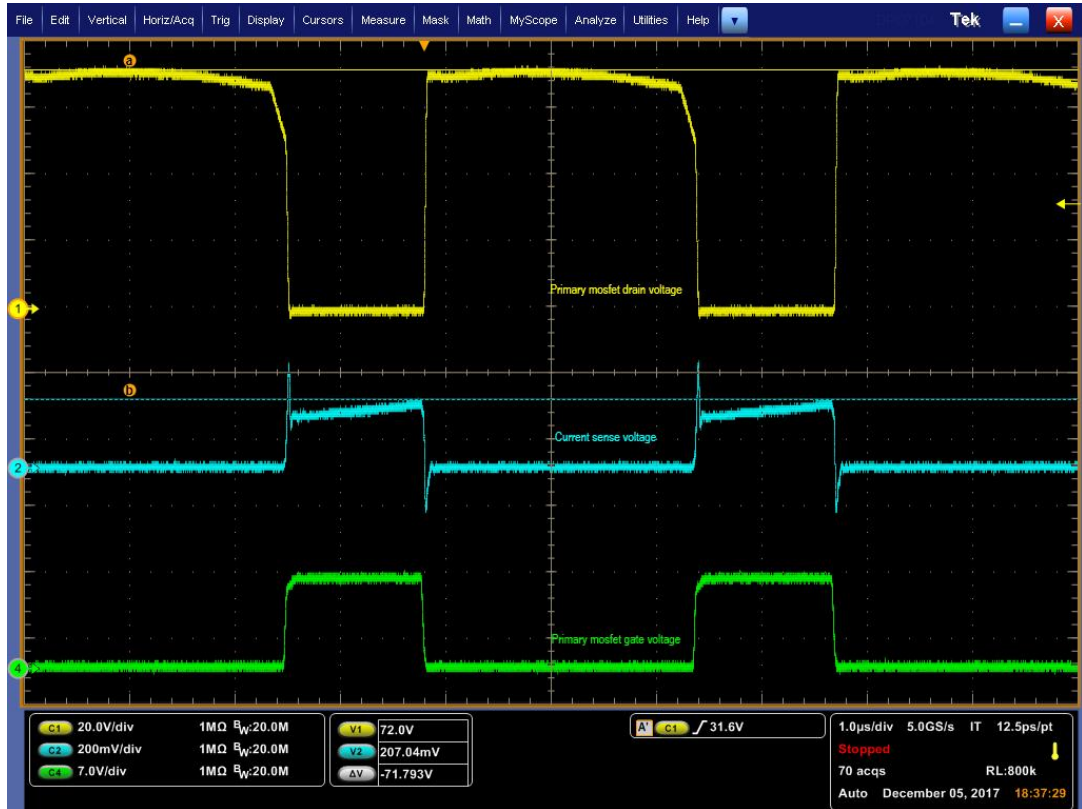

3.7 Secondary side waveforms

Figure 18. Secondary steady state: $I_{out}=2\text{ A}$, $V_{in}=48\text{ V}$

- Ch1: Secondary Q1 MOSFET drain voltage; Ch2: Secondary Q5 MOSFET drain voltage
- Ch3: Secondary Q1 MOSFET gate voltage; Ch4: Secondary Q5 MOSFET gate voltage

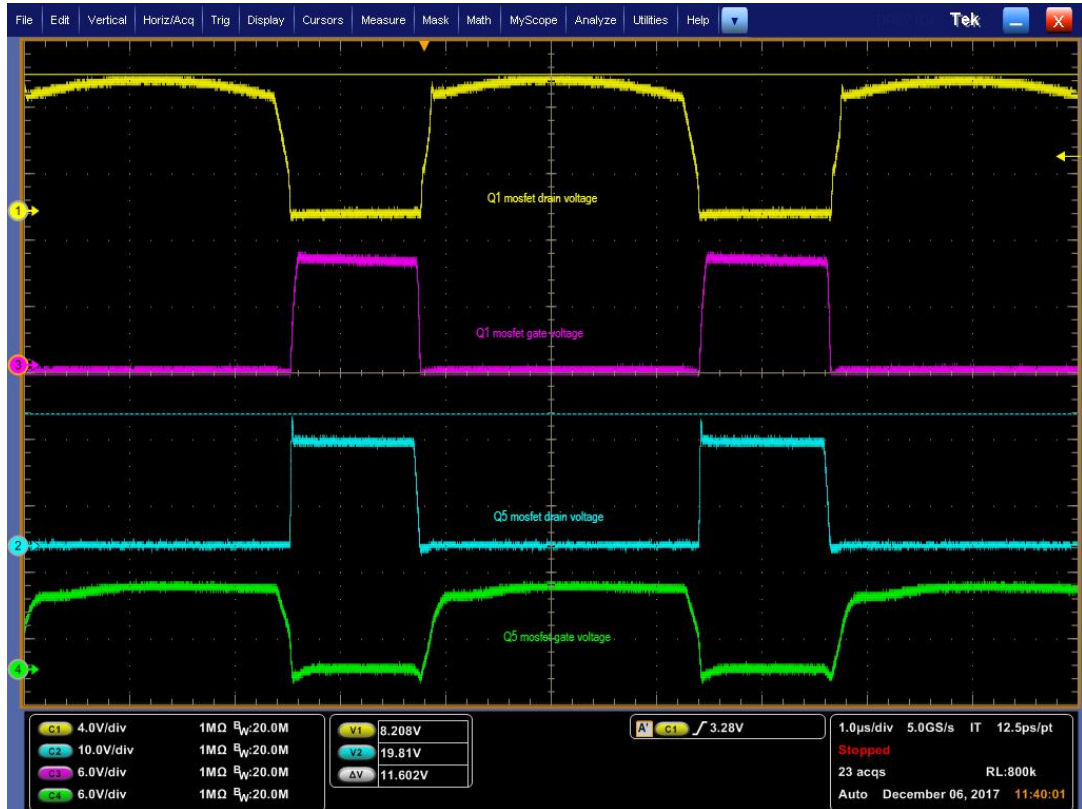
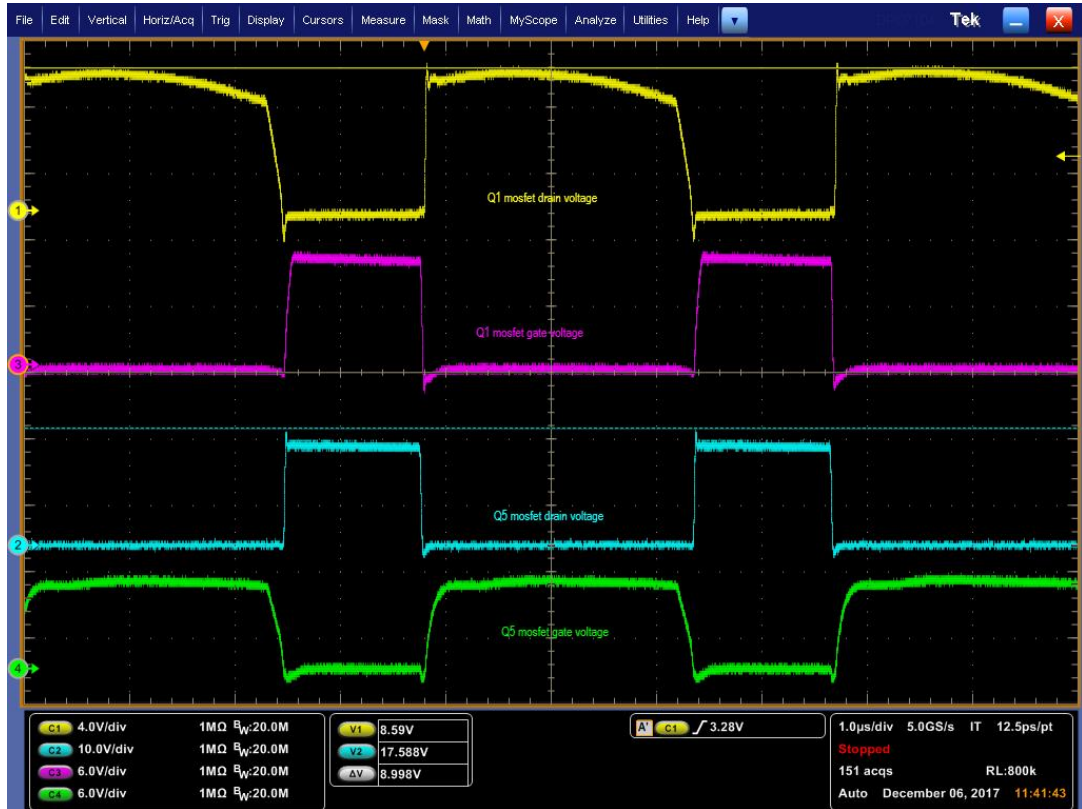

Figure 19. Secondary steady state: $I_{out}=20\text{ A}$, $V_{in}=48\text{ V}$

- Ch1: Secondary Q1 MOSFET drain voltage; Ch2: Secondary Q5 MOSFET drain voltage
- Ch3: Secondary Q1 MOSFET gate voltage; Ch4: Secondary Q5 MOSFET gate voltage



3.8 Load transient side waveforms

Figure 20. Load transient: I_{out}=10 to 20 A, V_{in}= 48 V

- Ch1: Output voltage; Ch2: Output current



3.9 Gloop measurements

Figure 21. Gloop plot (V_{in}= 48 V, I_{out}=13 A)

Figure 22. Gloop plot (Vin= 48 V, Iout=1 A)



3.10 Board thermography

Figure 23. STEVAL-POE003V1 reference design thermography at 20 A, 56 V for one minute (emissivity = 0.95, reflected temperature = 20°C)

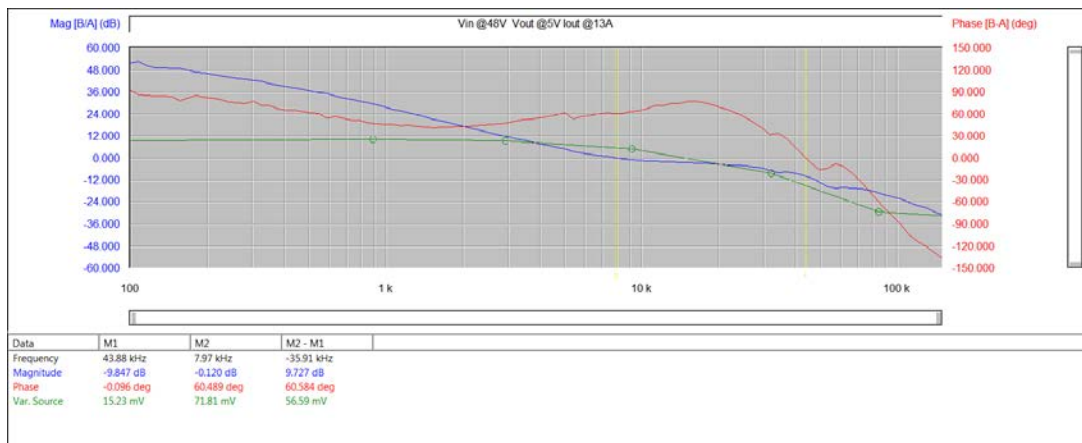
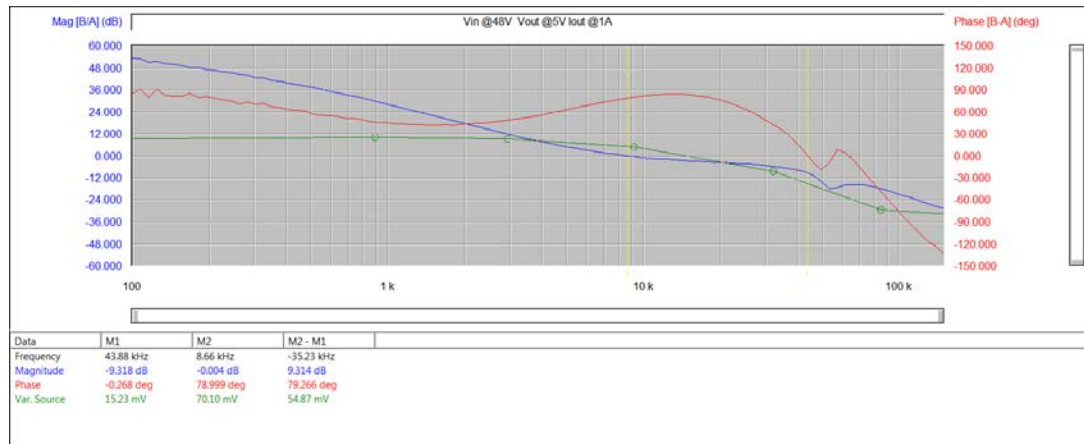
- SP1 (Q1 secondary rectifier MOSFET) = 93.6°C
- SP2 (Q5 secondary freewheeling MOSFET) = 81.5°C
- SP3 (Q4 primary main MOSFET) = 82°C
- SP4 (T3 forward transformer) = 70.3°C
- SP5 (L4 output inductor) = 62.5°C
- SP6 (U1 PM8805) = 60.3°C
- SP7 (Reference point) = 40.3°C

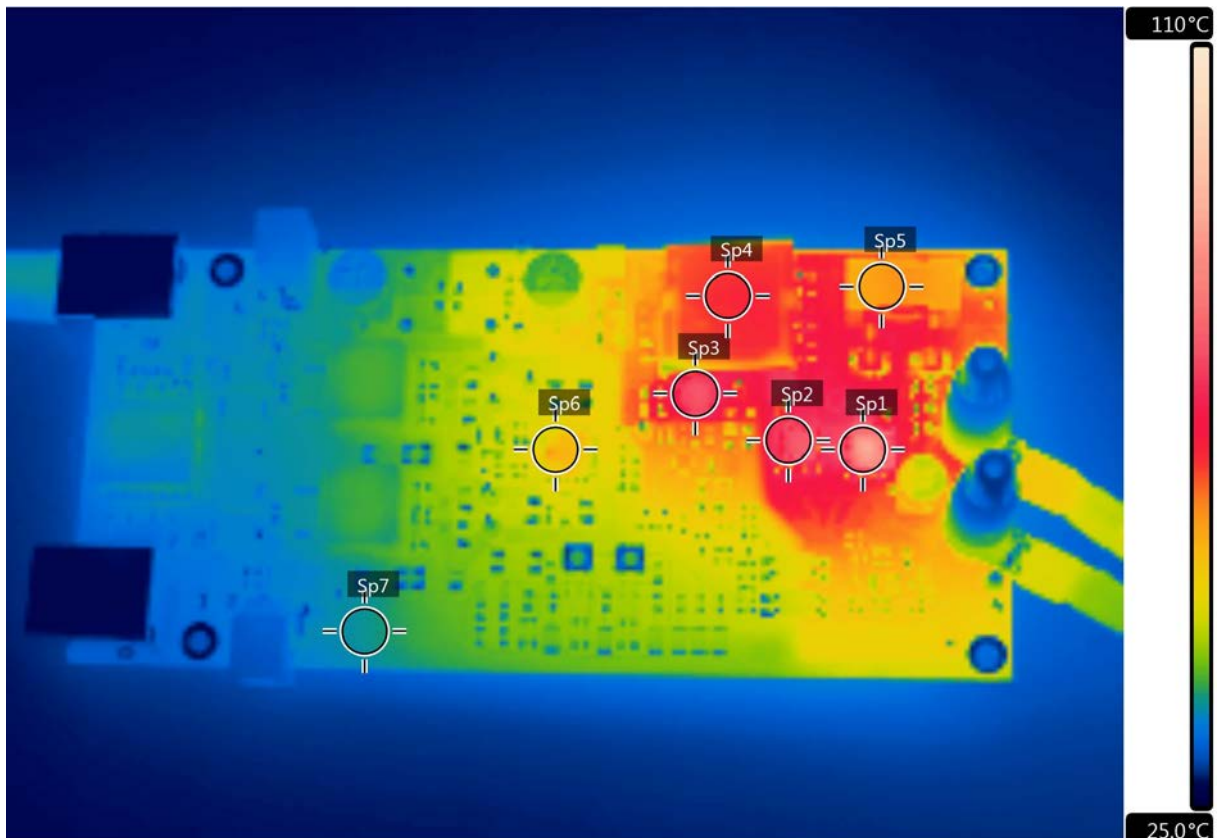

Figure 24. STEVAL-POE003V1 reference design thermography at 20 A, 56 V for five minutes (emissivity = 0.95, reflected temperature = 20°C)

- SP1 (Q1 secondary rectifier MOSFET) = 105.7°C
- SP2 (Q5 secondary freewheeling MOSFET) = 93.3°C
- SP3 (Q4 primary main MOSFET) = 89.6°C
- SP4 (T3 forward transformer) = 80.5°C
- SP5 (L4 output inductor) = 75.9°C
- SP6 (U1 PM8805) = 63.3°C
- SP7 (Reference point) = 41.5°C

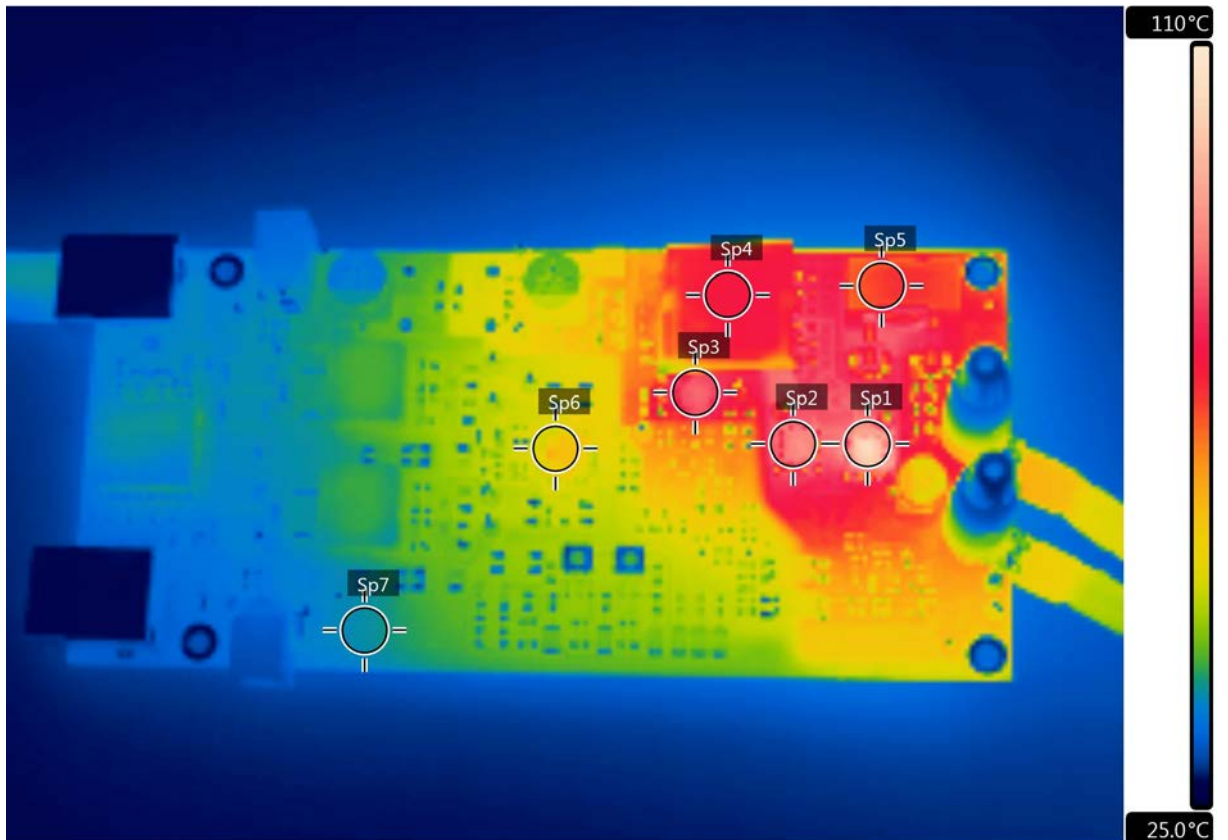

Figure 25. STEVAL-POE003V1 reference design thermography at 13 A, 41 V (emissivity = 0.95, reflected temperature = 20°C)

- SP1 (Q1 secondary rectifier MOSFET) = 67.4°C
- SP2 (Q5 secondary freewheeling MOSFET) = 66°C
- SP3 (Q4 primary main MOSFET) = 69°C
- SP4 (T3 forward transformer) = 65.6°C
- SP5 (L4 output inductor) = 58.6°C
- SP6 (U1 PM8805) = 54.2°C
- SP7 (Reference point) = 39.4°C

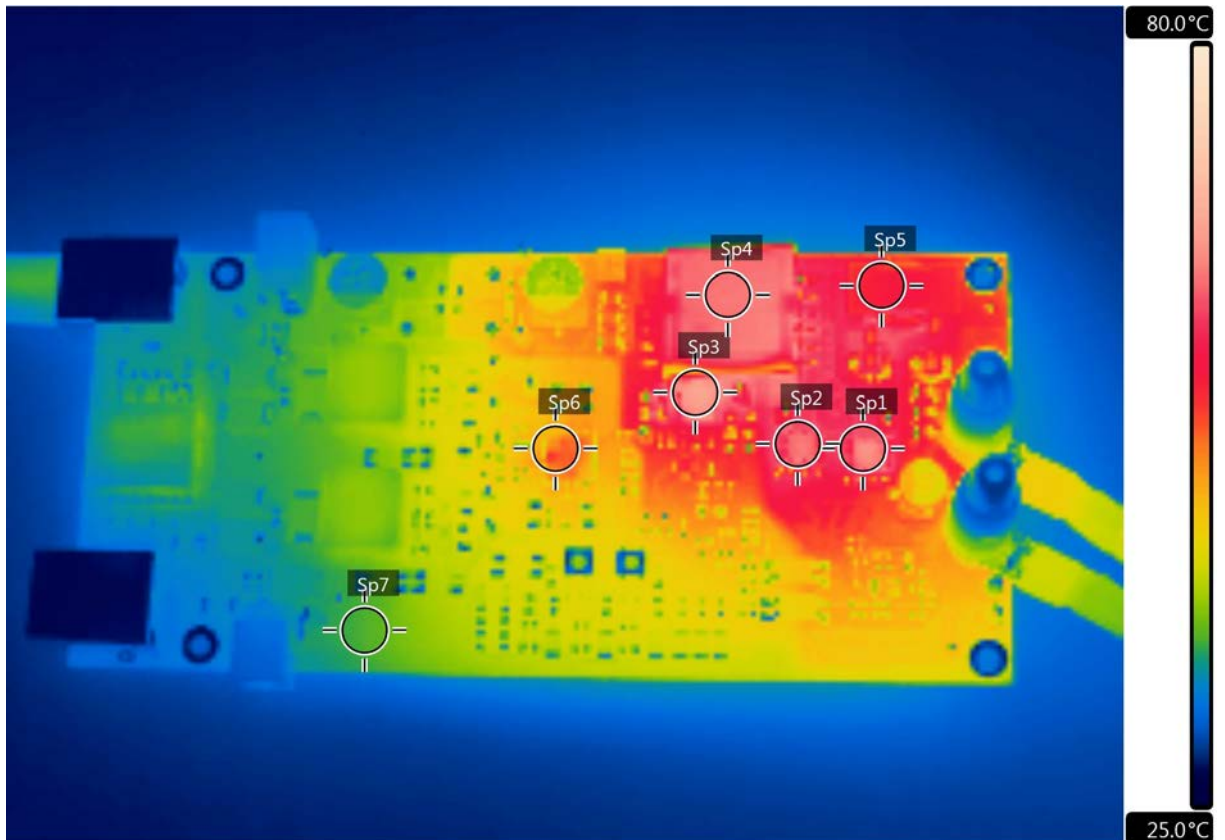
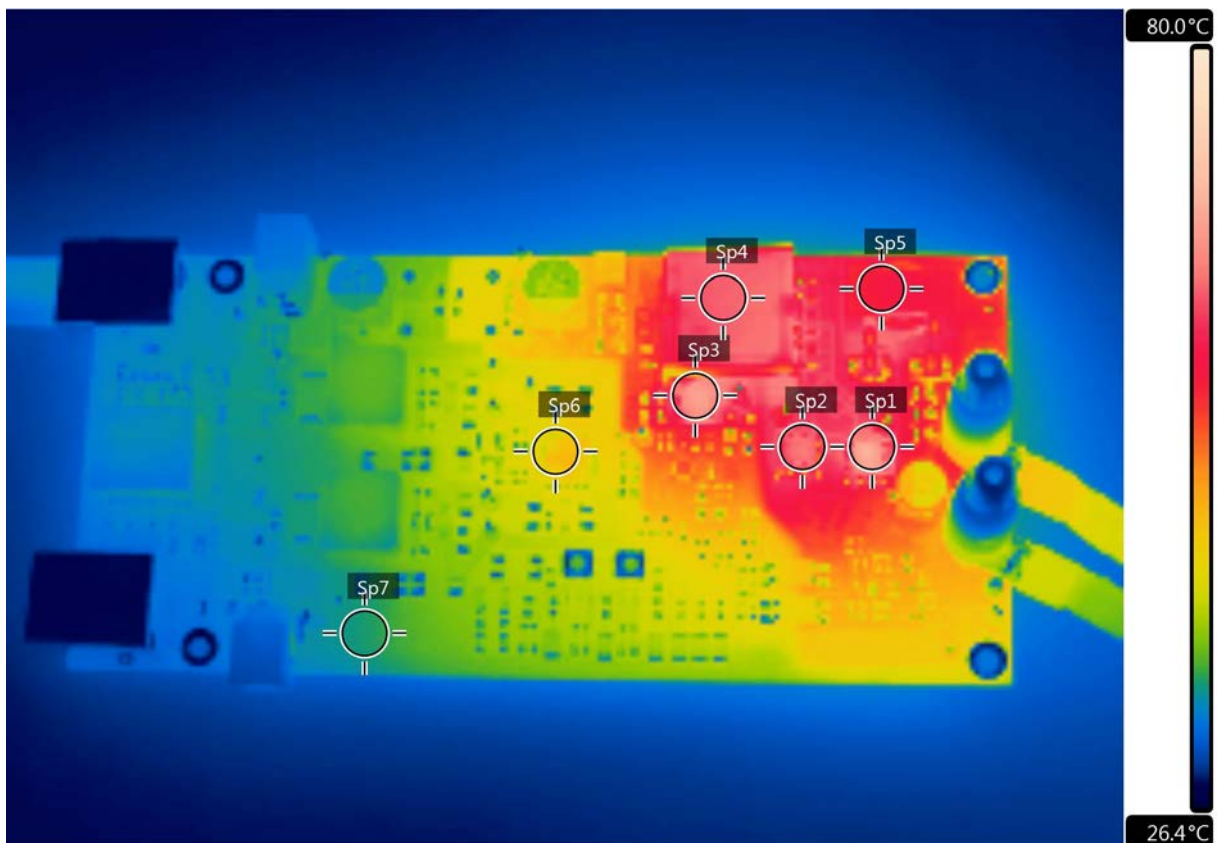

Figure 26. STEVAL-POE003V1 reference design thermography at 13 A, 56 V (emissivity = 0.95, reflected temperature = 20°C)

- SP1 (Q1 secondary rectifier MOSFET) = 69.6°C
- SP2 (Q5 secondary freewheeling MOSFET) = 66.1°C
- SP3 (Q4 primary main MOSFET) = 69.6°C
- SP4 (T3 forward transformer) = 65°C
- SP5 (L4 output inductor) = 59.8°C
- SP6 (U1 PM8805) = 48.8°C
- SP7 (Reference point) = 36.9°C



4 STEVAL-POE003V1 schematic diagrams

Figure 27. STEVAL-POE003V1 circuit schematic (1 of 3)

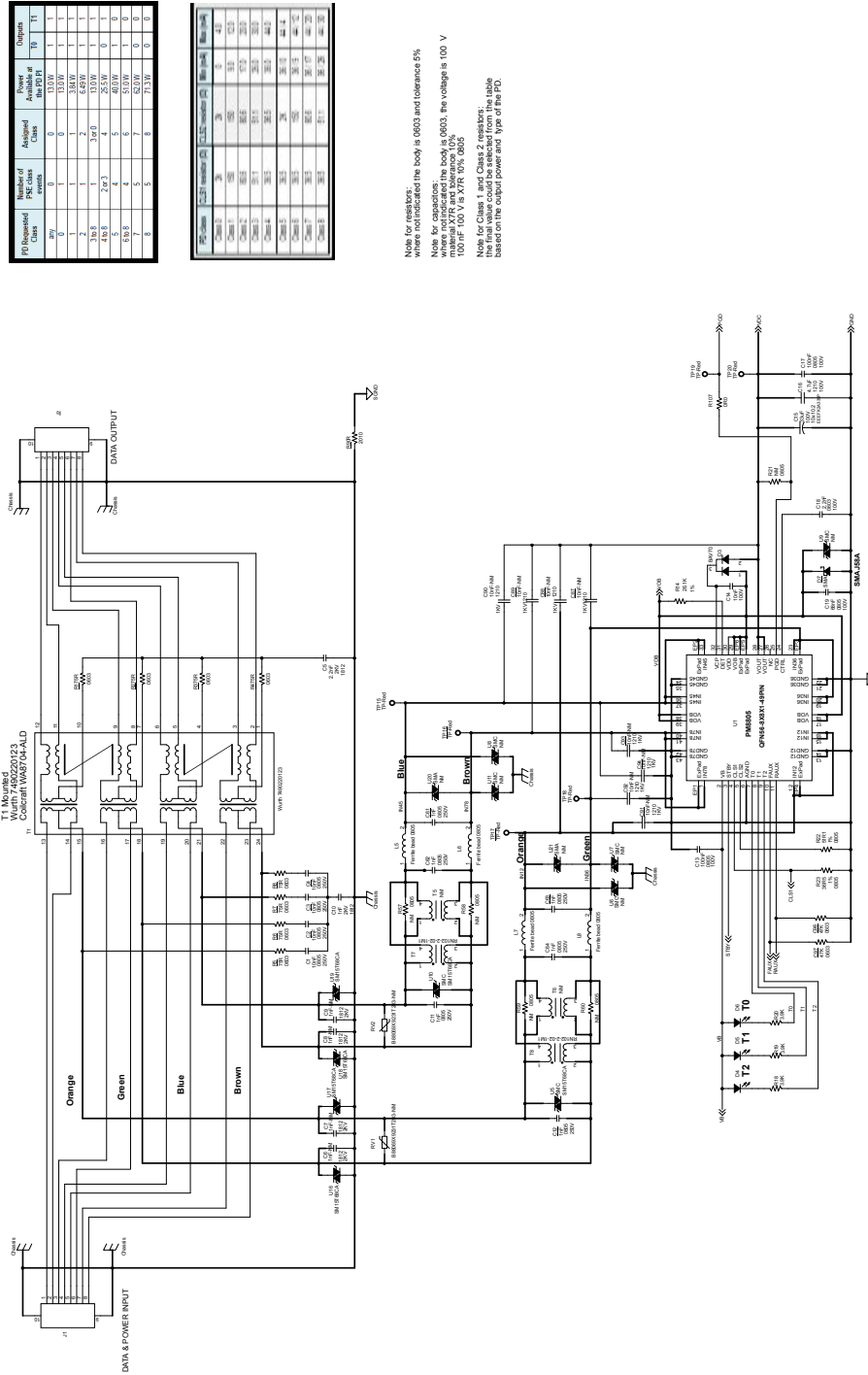

NOTE: For resistors, where indicated the body is 0603 and tolerance 5%.

NOTE: For capacitors, where indicated the body is 0603, the voltage is 100 V 100 nF 100 V or X7R 5% 0603.

NOTE: For Class 1 and Class 2 resistors, the final value could be selected from the table based on the output power and type of the PD.

PD (Watt)	Number of PSE class events	Assigned Value	Power Available at the PSE PD	Output
0.75	1	0	13.5W	1
1	1	1	13.5W	1
1	1	1	33.6W	1
1	1	1	13.5W	1
3.75	1	3.75	13.5W	1
4.5	2 or 3	4	25.5W	0
5.25	4	5	13.5W	1
5.25	5	7	52.5W	0
5.25	5	8	13.5W	0

Color	Value	Power	Output
Orange	0	13.5W	1
Green	1	13.5W	1
Blue	3.75	13.5W	1
Brown	4	25.5W	0
	5	13.5W	1
	7	52.5W	0
	8	13.5W	0

NOTE: For resistors, where indicated the body is 0603 and tolerance 5%.

NOTE: For capacitors, where indicated the body is 0603, the voltage is 100 V 100 nF 100 V or X7R 5% 0603.

NOTE: For Class 1 and Class 2 resistors, the final value could be selected from the table based on the output power and type of the PD.

Figure 28. STEVAL-POE003V1 circuit schematic (2 of 3)

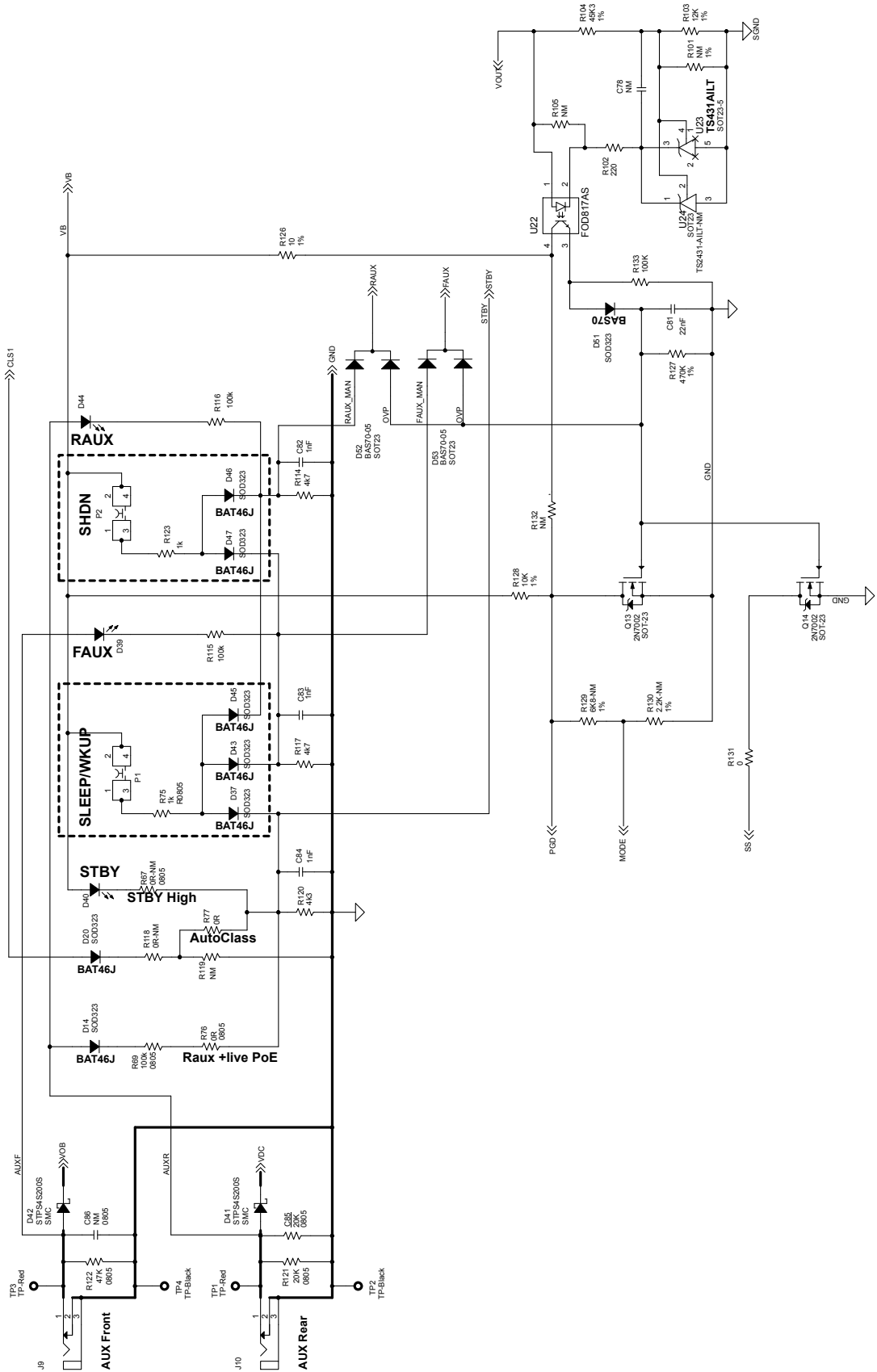
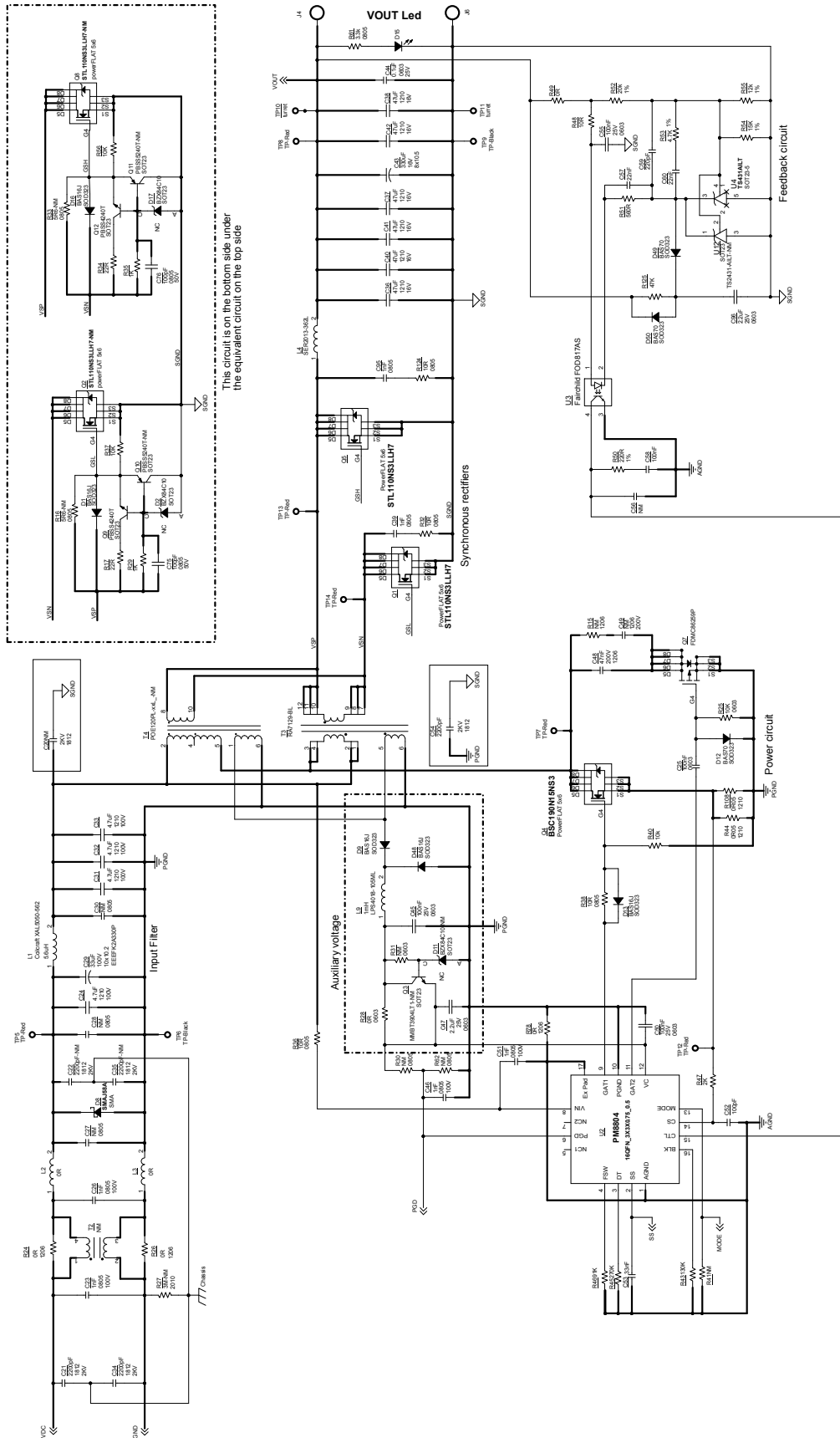

Figure 29. STEVAL-POE03V1 circuit schematic (3 of 3)



5 Bill of materials

Table 8. STEVAL-POE003V1 bill of materials

Item	Q.ty	Ref.	Description	Part/Value	Manufacturer	Order code
1	4	C1, C2, C3, C4	Capacitors	10 nF 250 V C0805	TDK	C2012X7R2E103K125AA
2	1	C5	Capacitor	2.2 nF 2KV C1812	AVX	
3	4	C6, C7, C8, C9	Capacitors N.M.	1 nF 2KV C1812	TDK	
4	1	C10	Capacitor	1nF 2KV C1812	AVX	
5	2	C11, C12	Capacitors	1 nF 250 V C0805	TDK	
6	2	C13, C17	Capacitors	100 nF 100 V C0805	Any	
7	1	C14	Capacitor	10 nF 100 V C0603	Any	
8	1	C15	Aluminium Electrolytic capacitor	33 μ F 100 V C-POL8-10	Panasonic	EEEFK2A330P
9	2	C16, C24	Capacitor	4.7 μ F 100 V C1210	TDK	
10	1	C18	Capacitor	2.2 nF 100 V C0603	Several	
11	1	C19	Capacitor	68 nF 100 V C0805	Several	
12	2	C20, C22	Capacitors N.M.	2200 pF 2KV C1812	AVX	
13	3	C21, C34, C35, C54	Capacitors	2200 pF 2KV C1812	AVX	
14	2	C23, C26, C39, C46, C86, C95	Capacitor	1 nF 100 V C0805	Any	
15	1	C25, C44, C45, C50, C51, C55, C56, C58	Capacitor	100 nF 25 V C0603	Any	
16	2	C27, C28, C30	Capacitors N.M.	100 V C0805	Any	
17	1	C29	Aluminium Electrolytic capacitor	33 μ F 100 V C-POL8-10	Panasonic	EEEFK2A330P
18	3	C31, C32, C33	Capacitors	4.7 μ F 100 V C1210	TDK	
19	6	C36, C37, C38, C40, C41, C42	Capacitor	47 μ F 16 V C1210	Murata	GRM32ER61C476ME15
20	1	C43	Aluminium Electrolytic capacitor	330 μ F 16 V Case F	Panasonic	EEEFK1C331GP
21		C47, C96	Capacitor	2.2 μ F 25 V C0603	Any	

Item	Q.ty	Ref.	Description	Part/Value	Manufacturer	Order code
22		C48, C49	Capacitor	47 nF 200 V C1206	Any	
23		C52	Capacitor	100 pF 25 V C0603	Any	
24		C53	Capacitor	33 nF 25 V C0603	Any	
25		C57, C60, C61, C62, C63, C64, C81	Capacitor	22 nF COG 25 V C0603	Any	
26		C59	Capacitor	220 pF COG 25 V C0603	Any	
27		C75, C76	Capacitor	100 pF 50 V C0805	Any	
28		C78	Capacitor N.M.	25 V C0603	Any	
29		C82, C83, C84	Capacitor	1 nF 100 V C0603	Any	
30		C85	Capacitor	20 K 0805	Any	
31		C87, C88, C89, C90, C91, C92, C93, C94	Capacitors N.M.	10 nF 1KV C1210	AVX	1210AC103KAT1A
32		C97, C98	Capacitors	47 K 0603	Any	
33		D1, D9, D13, D16, D48	Diode	SOD-323	Any	BAS16J
34		D2, D17	Diode	SOD-23	Any	BZX84C10
35		D3	Diode	SOT23	Any	BAV70
36		D4, D5, D6	LED diodes	T2	Kingbright	AA3528CGSK
37		D7	Diode TVS	SMA	ST	SMAJ58A
38		D8	Transil Diode	SMA	ST	SMAJ58A
39		D11	Zener diode N.M.	SOT23-D	Any	BZX84C10
40		D12, D49, D50, D51	Diode	SOD-323	Any	BAS70
41		D14, D20, D37, D43, D45, D46, D47	Diode	SOD323	ST	BAT46J
42		D15	LED Diode	VOUT Led LED_SMD_0805	Any	
43		D39	LED Diode	FAUX	Kingbright	AA3528CGSK
44		D40	LED Diode	STBY	Kingbright	AA3528CGSK
45		D41, D42	Diode	SMC	ST	STPS4S200S
46		D44	LED Diode	RAUX	Kingbright	AA3528CGSK
47		D52, D53	Dual Diode Common anodes	SOT-23	Any	BAS70-05
48		J1, J2	Connector	RJ45-8PIN	Bell Stewart	SS-7188S-A-NF

Item	Q.ty	Ref.	Description	Part/Value	Manufacturer	Order code
49		J4, J6	Connector	BANANA-JACK BOC_10A	Any	
50		J9	Power Jack	AUX Front	Switchcraft	P-JACK-RAPC722
51		J10	Power Jack	AUX Rear	Switchcraft	P-JACK-RAPC722
52		L1	Inductor	Power inductor	Wurth Elektronik	74439346056
53		L1	Inductor	Power inductor	Coilcraft	XAL5050-562
54		L2, L3	Inductor N.M.	220 R 805	TDK	MPZ2012S221AT000
55		L4	Inductor	3.6 μ H	Coilcraft	SER2013-362L
56		L5, L6, L7, L8	Ferrite beads	220 R 805	TDK	MPZ2012S221AT000
57		L9	Low profile power inductor		Coilcraft	LPS4018-105ML
58		P1	Push button	SLEEP/WKUP push-7914	Bourns	
59		P2	Push button	SHDN push-7914	Bourns	
60		Q1, Q5	Power MOSFET	POWERFLAT_5X 6_SGD	ST	STL110NS3LLH7
61		Q2	Power MOSFET N.M.	STL110NS3LLH7 POWERFLAT_5X 6_SGD	ST	STL110NS3LLH7
62		Q3	Switching transistor N.M.	MMBT3904LT1 SOT23_BEC_T	Any	MMBT3904LT1
63		Q4	Power MOSFET	BSC190N15NS3 POWERFLAT_5X 6_SGD	Infineon	BSC190N15NS3
64		Q7	Switching MOSFET P channel	POWERFLAT_3X 3_SGD		FDMC86259P
65		Q8	Power MOSFET N.M.	POWERFLAT_5X 6_SGD	ST	STL110NS3LLH7
66		Q9, Q12	Switching transistor NPN	SOT23_BEC_T	Any	PBSS4240T
67		Q10, Q11	Switching transistor PNP N.M.	SOT23_BEC_T	Any	PBSS5240T
68		Q13, Q14	N channel MOSFET	SOT23	Any	2N7002
69		R1, R2, R3, R4, r5, R6, R7, R8	Resistor	75 R R0603	Any	
70		R9	Resistor	0R0 R1210	Any	
71		R14	Resistor	26.1 K \pm 1% R0603	Any	
72		R15	Resistor N.M.	R1206	Any	
73		R16, R33	Resistor N.M.	5R6 R0805	Any	
74		R17	Resistor	22 R R0805	Any	
75		R18, R19, R20	Resistor	3.9 K R0603	Any	
76		R21, R30	Resistor N.M.	10 K R0805	Any	

Item	Q.ty	Ref.	Description	Part/Value	Manufacturer	Order code
77		R22	Resistor	51R1 ±1% R0805	Any	
78		R23	Resistor	36R5 ±1% R0805	Any	
79		R24, R26	Resistor	0R0 R1206	Any	
80		R25, R37, R40, R56	Resistor	10 K R0603	Any	
81		R27	Resistor N.M.	R2010	Any	
82		R28	Resistor	0 R R0603	Any	
83		R29, R35	Resistor	1 K R0805	Any	
84		R31, R41	Resistor N.M.	R0603	Any	
85		R32, R36, R38	Resistor	10 R R0805	Any	
86		R34	Resistor	22 R R0805	Any	
87		R43	Resistor	130 K ±1% R0603	Any	
88		R44	Resistor	R050 ±1% R1210	Any	
89		R45	Resistor	270K ±1% R0603	Any	
90		R46	Resistor	91K ±1% R0603	Any	
91		R47	Resistor	2 K R0603	Any	
92		R48	Resistor	10 R ±1% R0603	Any	
93		R49	Resistor	0R0 R0603	Any	
94		R50	Resistor	220 R ±1% R0603	Any	
95		R51	Resistor	560R ±1% R0603	Any	
96		R52	Resistor	20 k ±1% R0603	Any	
97		R53	Resistor	4.7 K±1% R0603	Any	
98		R54	Resistor	15 K ±1% R0603	Any	
99		R55	Resistor	12 K ±1% R0603	Any	
100		R57, R58, R9, R60	Resistor N.M.	0R0 R0805 N.M.	Any	
101		R61	Resistor	3K3 R0805	Any	
102		R62	Resistor N.M.	5K6 R0805	Any	
103		R67	Resistor N.M.	0 R R0805	Any	
104		R69	Resistor	100 k R0805	Any	
105		R75, r123	Resistor	1 k R0805	Any	
106		R76, R77, R118	Resistor	0R R0805	Any	
107		R78	Resistor	0 R R1206	Any	
108		R101	Resistor N.M.	±1% R0603	Any	
109		R102	Resistor	220 R R0603	Any	
110		R103	Resistor	12k ±1% R0603	Any	
111		R104	Resistor	45.3 K±1% R0603	Any	
112		R105	Resistor N.M.	R0603	Any	
113		R107	Resistor	0R0 R0805	Any	

Item	Q.ty	Ref.	Description	Part/Value	Manufacturer	Order code
114		R108	Resistor	R050 R1210	Any	
115		R114	Resistor	4k7 R0603	Any	
116		R115, R116	Resistor	100k R0805	Any	
117		R117	Resistor	4k7 R0603	Any	
118		R119	Resistor N.M.	100 k R0603	Any	
119		R120	Resistor	4k3 R0603	Any	
120		R121	Resistor	20 K R0805	Any	
121		R122	Resistor	47 K R0805	Any	
122		R124	Resistor	10 R R0805	Any	
123		R125	Resistor	47 K R0603	Any	
124		R126	Resistor	10 R0603	Any	
125		R127	Resistor	470 K R0603	Any	
126		R128	Resistor	10 K R0603	Any	
127		R129	Resistor N.M.	6K8 R0603	Any	
128		R130	Resistor N.M.	2K2 R0603	Any	
129		R131, R132	Resistor	0R0 R0603	Any	
130		R133	Resistor	100 K R0603	Any	
131		RV1, RV2	Surge arrester N.M.	1812	TDK	B88069X9231T203
132		T1	Data Trafo	POE Trafo	Würth Elektronik	7490220123
133		T2	Common Choke N.M.	RN112	Schaffner	RN 112-4-02-0M7
134		T3	Power Trafo	RA7129-BL	Coilcraft	
135		T4	Planar Power Trafo N.M.		Coilcraft	
136		T5, T6	Common Choke N.M.	WURTH_WE-SL5	Würth Elektronik	744272471
137		T7, T8	Common Choke	RN102	Schaffner	RN 102-2-02-1M1
138		TP1, TP3, TP5, TP7, TP8, TP12, TP13, TP14, TP15, TP16, TP17, TP18, TP19, TP20	Test point red	KEYSTONE_501 0	Keystone	
139		TP2, TP4, TP6, TP9	Test point black	KEYSTONE_501 1	Keystone	
140		TP10, TP11	Test point turret	MILLMAX_2501	Millmax	
141		U1	Controller	QFN56-8X8X1-49 PIN	ST	PM8805
142		U2	Controller	16QFN_3X3X0.7 5_0.5	ST	PM8804
143		U3	Optocoupler		Fairchild	FOD817AS

Item	Q.ty	Ref.	Description	Part/Value	Manufacturer	Order code
144		U4	Voltage Reference	SOT-23-5LEAD	ST	TS431AILT
145		U5	Transil	Diode TVS SMC	ST	SM15T68CA
146		U6, U7, U8, U9	Transil N.M.	Diode TVS SMC		
147		U10, U16	Transil	Diode TVS SMC	ST	SM15T68CA
148		U11	Transil N.M.	Diode TVS SMC		
149		U17, U18, U19	Transil	Diode TVS SMC	ST	SM15T68CA
150		U20, U21	Transil N.M.	Diode TVS SMC		
151		U22	Optocoupler	FOD817	Fairchild	FOD817AS
152		U23	Voltage Reference	SOT-23-5LEAD	ST	TS431AILT
153		U24	Voltage Reference N.M.	SOT-23-3L	ST	TS2431-AILT

6 Board layout

Figure 30. STEVAL-POE003V1 reference design: PCB top assembly

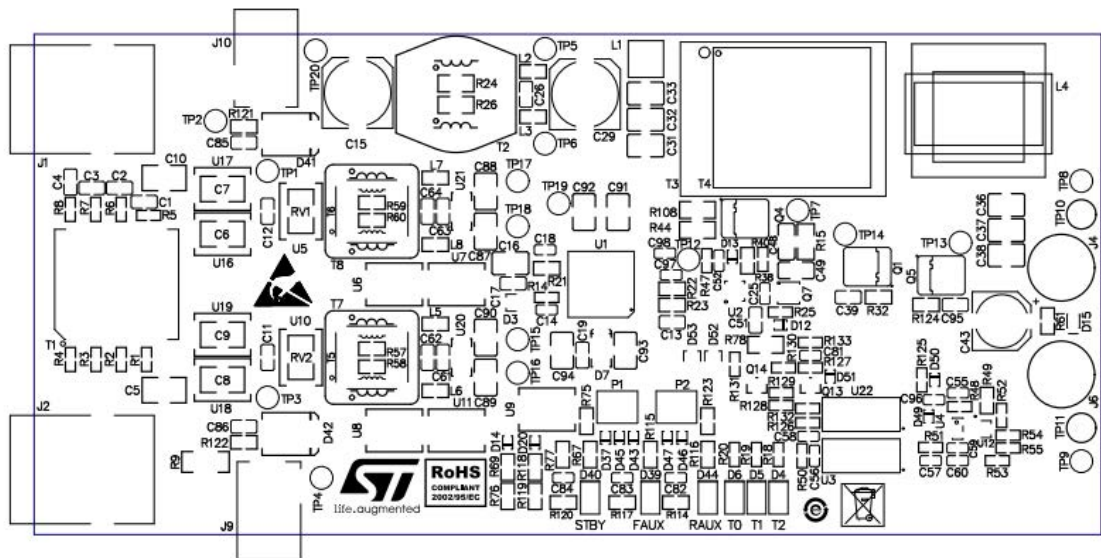

Figure 31. STEVAL-POE003V1 reference design: PCB bottom assembly

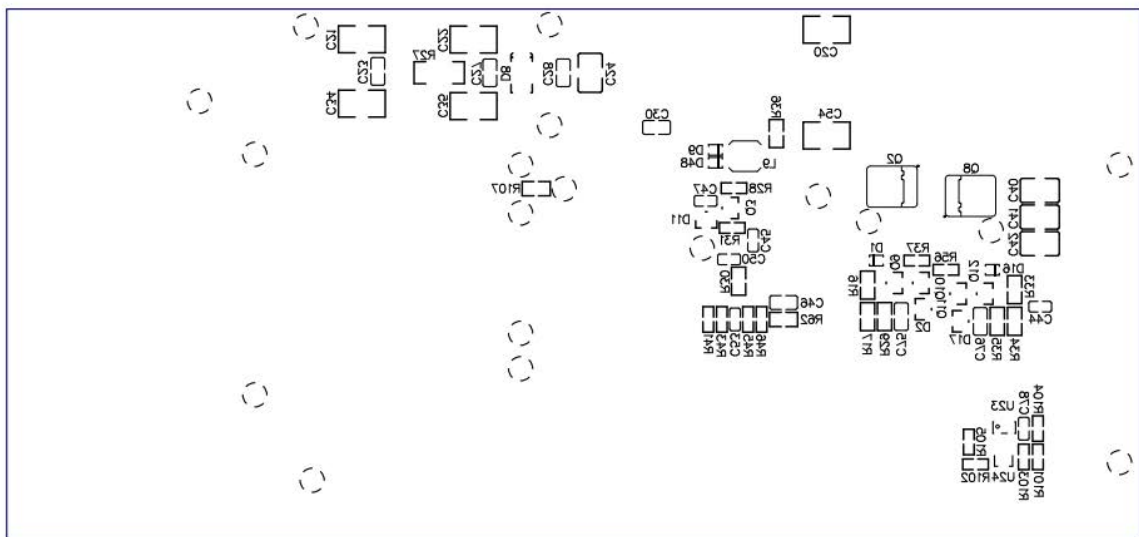

Figure 32. STEVAL-POE003V1 reference design: PCB layer 1 (top)

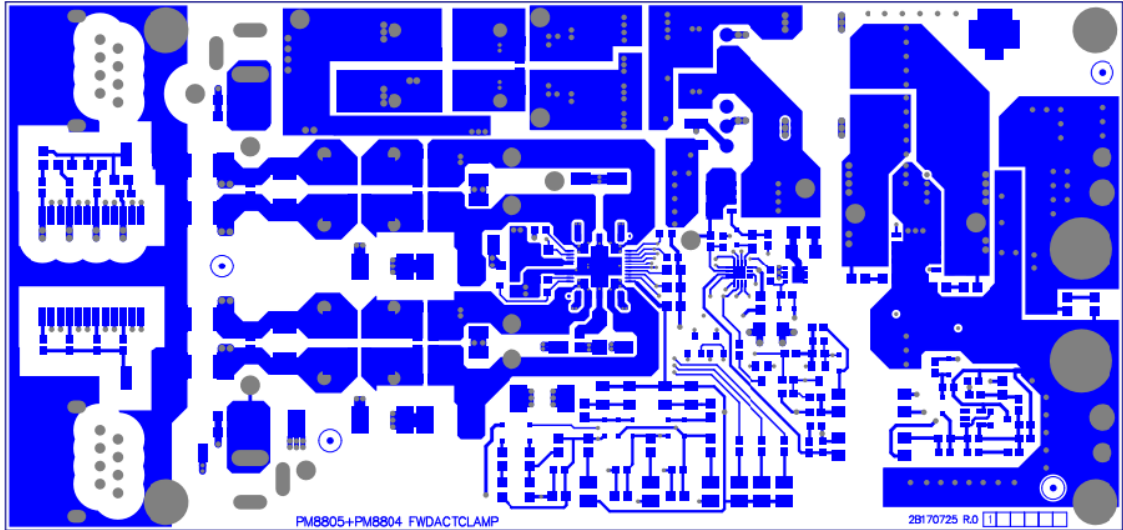

Figure 33. STEVAL-POE003V1 reference design: PCB layer 2

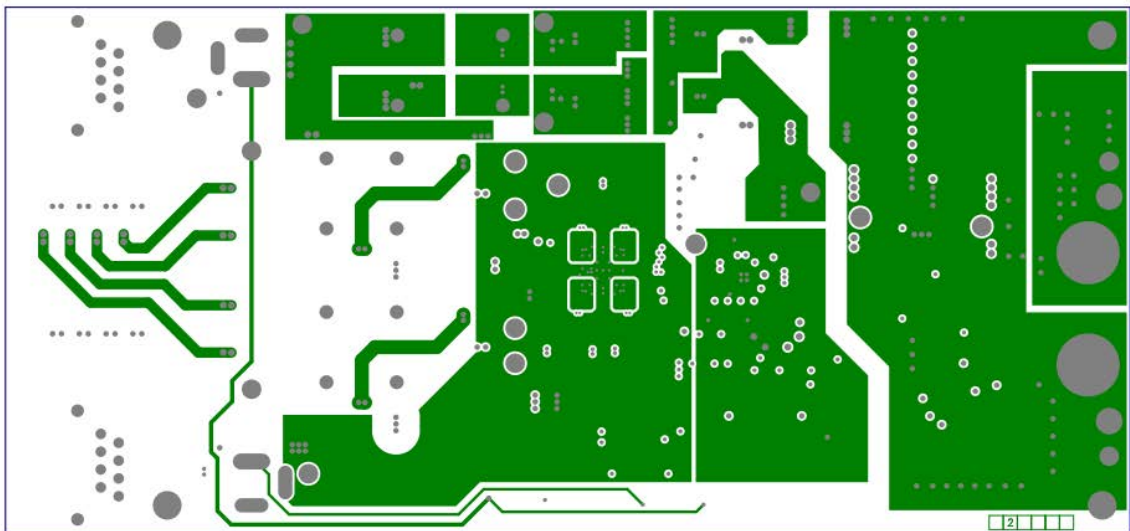

Figure 34. STEVAL-POE003V1 reference design: PCB layer 3

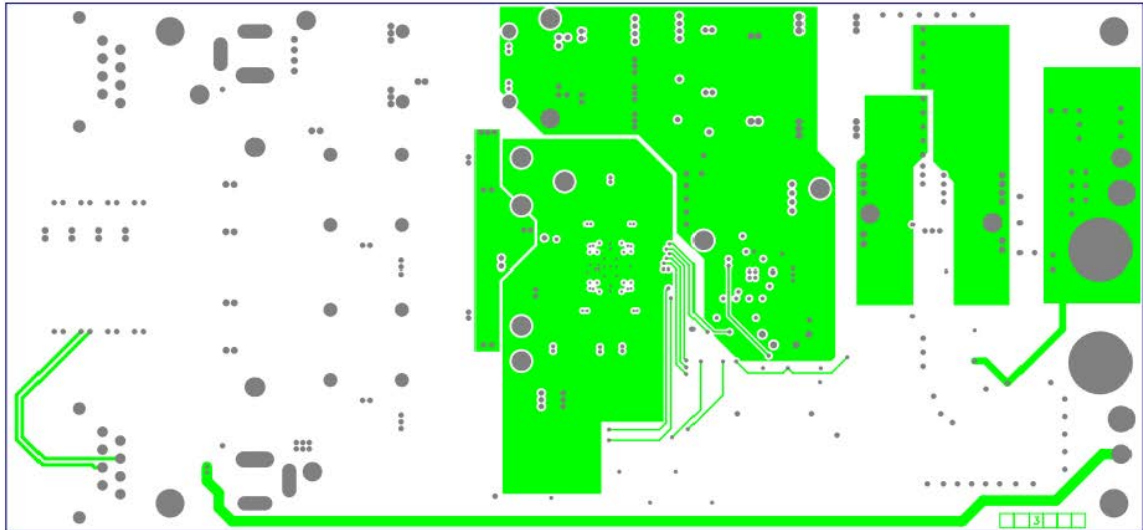

Figure 35. STEVAL-POE003V1 reference design: PCB layer 4

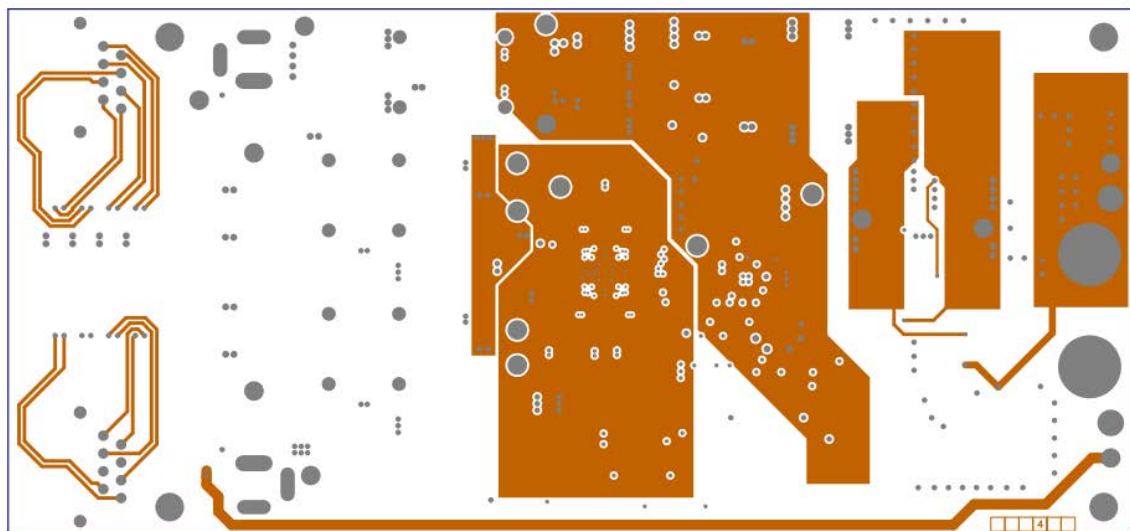

Figure 36. STEVAL-POE003V1 reference design: PCB layer 5

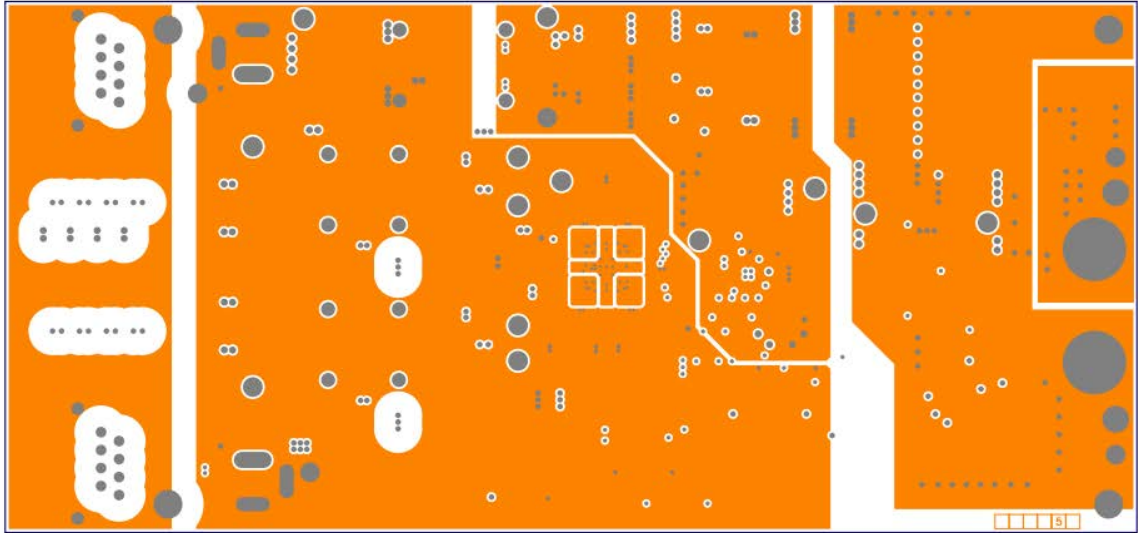

Figure 37. STEVAL-POE003V1 reference design: PCB layer 6



A References

Freely available on www.st.com:

1. [PM8804](#) datasheet
2. [PM8805](#) datasheet

Revision history

Table 9. Document revision history

Date	Version	Changes
24-Aug-2018	1	Initial release.
09-May-2019	2	Updated title and Introduction.

Contents

1	STEVAL-POE003V1 reference design overview	2
1.1	Specifications, connectors and LEDs	2
1.2	Board setup	3
2	Configurations	5
2.1	PM8805 configurations	5
2.2	PoE	5
2.3	FAUX connector	6
2.4	RAUX with MPS	6
2.5	Soft stop	9
3	Measurements	10
3.1	Efficiency	10
3.2	Output voltage ripple	10
3.3	Input voltage ripple	12
3.4	Startup	14
3.5	PoE connector unplugged power off	16
3.6	Primary side waveforms	19
3.7	Secondary side waveforms	21
3.8	Load transient side waveforms	23
3.9	Gloop measurements	24
3.10	Board thermography	25
4	STEVAL-POE003V1 schematic diagrams	29
5	Bill of materials	32
6	Board layout	38
A	References	42
	Revision history	43

List of figures

Figure 1.	STEVAL-POE003V1 reference design	1
Figure 2.	STEVAL-POE003V1 reference design: components view	4
Figure 3.	PSE to RAUX switchover at $V_{PSE}=55\text{ V}$, $V_{RAUX}=48\text{ V}$, $I_{OUT}=13\text{ A}$	7
Figure 4.	RAUX to PSE switchover at $I_{OUT}=13\text{ A}$, $V_{RAUX}=48\text{ V}$, PSE voltage=55 V	8
Figure 5.	RAUX to PSE switchover at $I_{OUT}=13\text{ A}$	9
Figure 6.	STEVAL-POE003V1 overall and DC-DC efficiency	10
Figure 7.	Output voltage ripple: $I_{OUT}=2\text{ A}$	11
Figure 8.	Output voltage ripple: $I_{OUT}=20\text{ A}$	12
Figure 9.	Input voltage ripple before and after forward input filter: input voltage=48 A, $I_{OUT}=2\text{ A}$	13
Figure 10.	Input voltage ripple before and after forward input filter: input voltage=48 A, $I_{OUT}=20\text{ A}$	14
Figure 11.	Output voltage at startup: I_{out} at no load, $V_{in}=48\text{ V}$	15
Figure 12.	Output voltage at startup: $I_{out}=20\text{ A}$, $V_{in}=48\text{ V}$	16
Figure 13.	Power off at primary side: $I_{out}=18\text{ A}$, $V_{in}=42\text{ V}$	17
Figure 14.	Power off at secondary side (Q1): $I_{out}=18\text{ A}$, $V_{in}=42\text{ V}$	18
Figure 15.	Power off at secondary side (Q5): $I_{out}=18\text{ A}$, $V_{in}=42\text{ V}$	19
Figure 16.	Primary steady state: $I_{out}=2\text{ A}$, $V_{in}=48\text{ V}$	20
Figure 17.	Primary steady state: $I_{out}=20\text{ A}$, $V_{in}=48\text{ V}$	21
Figure 18.	Secondary steady state: $I_{out}=2\text{ A}$, $V_{in}=48\text{ V}$	22
Figure 19.	Secondary steady state: $I_{out}=20\text{ A}$, $V_{in}=48\text{ V}$	23
Figure 20.	Load transient: $I_{out}=10$ to 20 A , $V_{in}=48\text{ V}$	24
Figure 21.	Gloop plot ($V_{in}=48\text{ V}$, $I_{out}=13\text{ A}$)	24
Figure 22.	Gloop plot ($V_{in}=48\text{ V}$, $I_{out}=1\text{ A}$)	25
Figure 23.	STEVAL-POE003V1 reference design thermography at 20 A , 56 V for one minute (emissivity = 0.95, reflected temperature = 20°C)	25
Figure 24.	STEVAL-POE003V1 reference design thermography at 20 A , 56 V for five minutes (emissivity = 0.95, reflected temperature = 20°C)	26
Figure 25.	STEVAL-POE003V1 reference design thermography at 13 A , 41 V (emissivity = 0.95, reflected temperature = 20°C)	27
Figure 26.	STEVAL-POE003V1 reference design thermography at 13 A , 56 V (emissivity = 0.95, reflected temperature = 20°C)	28
Figure 27.	STEVAL-POE003V1 circuit schematic (1 of 3)	29
Figure 28.	STEVAL-POE003V1 circuit schematic (2 of 3)	30
Figure 29.	STEVAL-POE003V1 circuit schematic (3 of 3)	31
Figure 30.	STEVAL-POE003V1 reference design: PCB top assembly	38
Figure 31.	STEVAL-POE003V1 reference design: PCB bottom assembly	38
Figure 32.	STEVAL-POE003V1 reference design: PCB layer 1 (top)	39
Figure 33.	STEVAL-POE003V1 reference design: PCB layer 2	39
Figure 34.	STEVAL-POE003V1 reference design: PCB layer 3	40
Figure 35.	STEVAL-POE003V1 reference design: PCB layer 4	40
Figure 36.	STEVAL-POE003V1 reference design: PCB layer 5	41
Figure 37.	STEVAL-POE003V1 reference design: PCB layer 6	41

List of tables

Table 1.	STEVAL-POE003V1 specifications	2
Table 2.	STEVAL-POE003V1 connectors	2
Table 3.	STEVAL-POE003V1 LEDs	3
Table 4.	Tx signal possible configurations	3
Table 5.	PM8805 control signal description	5
Table 6.	PM8805 class description	5
Table 7.	PM8805 PD main parameters	6
Table 8.	STEVAL-POE003V1 bill of materials	32
Table 9.	Document revision history	43

IMPORTANT NOTICE – PLEASE READ CAREFULLY

STMicroelectronics NV and its subsidiaries (“ST”) reserve the right to make changes, corrections, enhancements, modifications, and improvements to ST products and/or to this document at any time without notice. Purchasers should obtain the latest relevant information on ST products before placing orders. ST products are sold pursuant to ST’s terms and conditions of sale in place at the time of order acknowledgement.

Purchasers are solely responsible for the choice, selection, and use of ST products and ST assumes no liability for application assistance or the design of Purchasers’ products.

No license, express or implied, to any intellectual property right is granted by ST herein.

Resale of ST products with provisions different from the information set forth herein shall void any warranty granted by ST for such product.

ST and the ST logo are trademarks of ST. For additional information about ST trademarks, please refer to www.st.com/trademarks. All other product or service names are the property of their respective owners.

Information in this document supersedes and replaces information previously supplied in any prior versions of this document.

© 2019 STMicroelectronics – All rights reserved