



AC/DC Converter
Non-Isolated Buck Converter
PWM type 8 W (20 V 0.4 A)
BM2PAB1Y Evaluation Board

User's Guide

<High Voltage Safety Precautions>

◇ Read all safety precautions before use

Please note that this document covers only the **BM2PAB1Y** evaluation board (BM2PAB1Y-EVK-003) and its functions. For additional information, please refer to the datasheet.

To ensure safe operation, please carefully read all precautions before handling the evaluation board



Depending on the configuration of the board and voltages used,

Potentially lethal voltages may be generated.

Therefore, please make sure to read and observe all safety precautions described in the red box below.

Before Use

- [1] Verify that the parts/components are not damaged or missing (i.e. due to the drops).
- [2] Check that there are no conductive foreign objects on the board.
- [3] Be careful when performing soldering on the module and/or evaluation board to ensure that solder splash does not occur.
- [4] Check that there is no condensation or water droplets on the circuit board.

During Use

- [5] Be careful to not allow conductive objects to come into contact with the board.
- [6] **Brief accidental contact or even bringing your hand close to the board may result in discharge and lead to severe injury or death.**

Therefore, DO NOT touch the board with your bare hands or bring them too close to the board.

In addition, as mentioned above please exercise extreme caution when using conductive tools such as tweezers and screwdrivers.

- [7] If used under conditions beyond its rated voltage, it may cause defects such as short-circuit or, depending on the circumstances, explosion or other permanent damages.
- [8] Be sure to wear insulated gloves when handling is required during operation.

After Use

- [9] The ROHM Evaluation Board contains the circuits which store the high voltage. Since it stores the charges even after the connected power circuits are cut, please discharge the electricity after using it, and please deal with it after confirming such electric discharge.
- [10] Protect against electric shocks by wearing insulated gloves when handling.

This evaluation board is intended for use only in research and development facilities and should be handled **only by qualified personnel familiar with all safety and operating procedures.**

We recommend carrying out operation in a safe environment that includes the use of high voltage signage at all entrances, safety interlocks, and protective glasses.

AC/DC Converter

Non-Isolated PWM type Buck Converter 8W 20 V Output BM2PAB1Y-Z Evaluation Board

BM2PAB1Y-EVK-003

General Description

The evaluation board outputs a voltage of 20 V non-isolated from inputs from 90 Vac to 264 Vac, with an output maximum current of 0.4 A.

It was developed mainly for power supplies for IH rice cookers and IH cookers.

The non-insulated output can be used as a power supply for control of inverters, etc.

A PWM controller for AC/DC power supplies, the BM2PAB1Y provides the ideal system for small appliances with outlets.



Figure 1. BM2PAB1Y-EVK-003

Performance Specification

Not guarantee the characteristics is representative value.

Unless otherwise specified $V_{IN} = 230 \text{ Vac}$, $I_{OUT} = 0.4 \text{ A}$, $T_a = 25 \text{ }^\circ\text{C}$

Parameter	Symbol	Min	Typ	Max	Units	Conditions
Input Voltage Range	V_{IN}	90	230	264	V	
Input Frequency	f_{LINE}	47	-	63	Hz	
Output Voltage	V_{OUT}	19.0	20.0	21.0	V	
Output Current Range <i>(Note 1)</i>	I_{OUT}	0.02	-	0.4	A	
Maximum Output Power	P_{OUT}			8.0	W	
Power supply efficiency	η	80.0	85.3	-	%	
Output Ripple Voltage <i>(Note 2)</i>	V_{ripple}	-	0.05	0.20	Vpp	
Operating Temperature	T_{op}	-10	+25	+65	$^\circ\text{C}$	

(Note 1) Adjust the load application time so that the component surface temperature does not exceed 105 $^\circ\text{C}$.

(Note 2) Not include spikes noise.

Derating

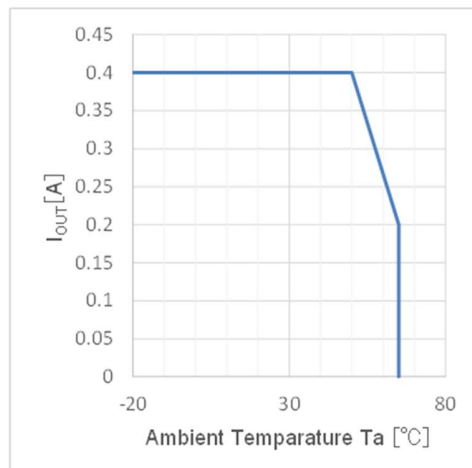

Figure 2. Temperature derating curve

Operation Procedure

1 Necessary Equipment

- (1) AC power supply 90 Vac to 264 Vac, over 10 W
- (2) Electronic load capacity 0.4 A.
- (3) Multi meter
- (4) Power meter

2 Connect to Each Equipment

- (1) AC power supply presetting range 90 to 264 Vac, Output switch is OFF.
- (2) Electronic load setting under 0.4 A, Load switch is OFF.
- (3) The reference board connects to measuring equipments and power supplies as in Figure.3.
- (4) AC power supply switch is ON.
- (5) Check that output voltage is 20 V.
- (6) Electronic load switch is ON.
- (7) Operate with enough caution against electric shock because of non-isolated output voltage 20 V.

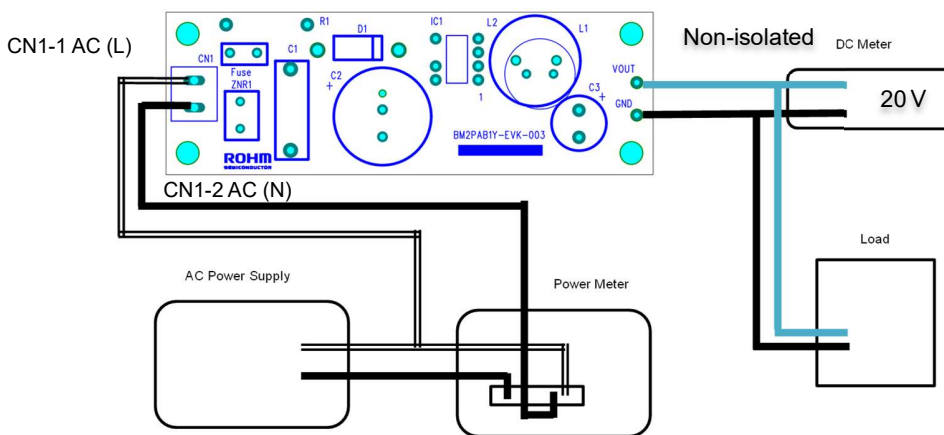

Figure 3. Diagram of How to Connect

Application Circuit

This evaluation board adopts a buck type circuit system.

The integrated MOSFET of IC1 monitors the output voltage (20 V) during the OFF period and presses a voltage to C5.

The voltage of C5 is feed back to the FB terminal (0.8 V) of the BM2PAB1Y-Z in the R2, R3, and R4 voltage circuits to keep the output voltage constant.

At startup, the VCC terminal voltage rises by supplying voltage from the DRAIN terminal to the VCC terminal through the start-up circuit.

When the VCC terminal voltage exceeds the UVLO release voltage of 10.4 V (Typ), the operation of the BM2PAB1Y-Z begins.

When operation starts, the start-up circuit turns off, disconnecting the supply from the DRAIN terminal, contributing to the reduction of standby power.

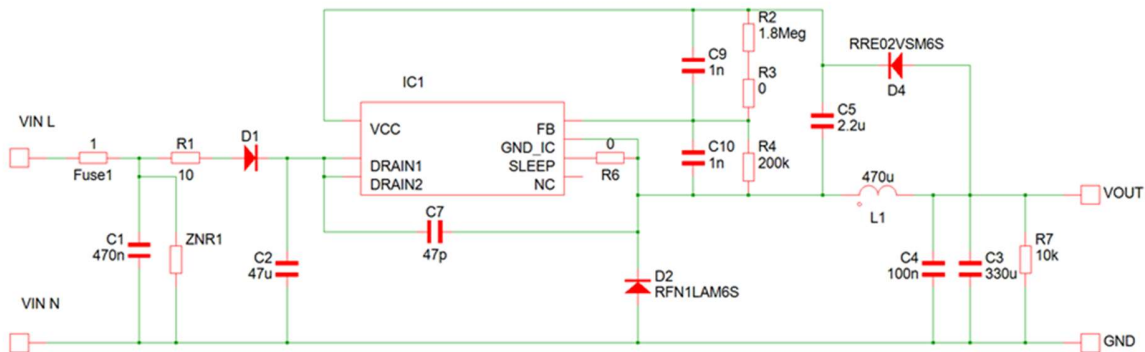

Figure 4. Application Circuit

BM2Pxx1Y Overview

Features

- PWM Current Mode
- Built-in Frequency Hopping Function
- Burst Operation at Light Load
- Built-in 730 V (peak) Starter Circuit
- Built-in 730 V (peak) Super Junction MOSFET
- VCC UVLO (Under Voltage Lockout)
- VCC OVP (Over Voltage Protection)
- Over Current Limiter Function per Cycle
- Soft Start Function
- Sleep Mode

Key Specifications

- Operating Power Supply Voltage Range
 - VCC 11.10 V to 26.00 V
 - DRAIN 730 V (peak)(Max)
- Operating Current (Normal): 650 μA (Typ)
- Operating Current (Burst): 350 μA (Typ)
- Operating Current (Sleep): 65 μA (Typ)
- Switching Frequency: 25 kHz / 65 kHz (Typ)
- Operation Temperature: -40 °C to +105 °C
- MOSFET ON Resistance: 1.2 Ω (Typ)

Application

Rice cooker, Air conditioner, Other white goods

Package

DIP7K

W (Typ) x D (Typ) x H (Typ)

9.27 mm x 6.35 mm x 8.63 mm

Pitch 2.54 mm

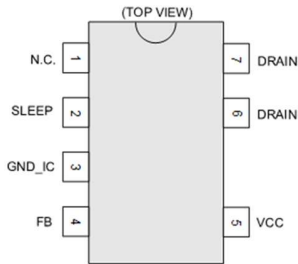

Figure 7. Pin Configuration

Lineup

Model Name	Switching Frequency	Frequency Reduction	OCP Current
BM2PAA1Y-Z	65 kHz	O	1.76 A
BM2PAB1Y-Z	25 kHz	-	
BM2PDA1Y-Z	65 kHz	O	0.93 A
BM2PDB1Y-Z	25 kHz	-	

Table 3. BM2Pxx1Y-Z Pin Description

No.	Name	I/O	Function
1	N.C.	-	Non connection
2	SLEEP	I	Sleep/Normal modes witching pin
3	GND_IC	I/O	GND pin
4	FB	I	Output voltage feedback pin
5	VCC	I	Input voltage pin
6	DRAIN	I/O	MOSFET drain pin
7	DRAIN	I/O	MOSFET drain pin

Measurement Data

1 Load Regulation

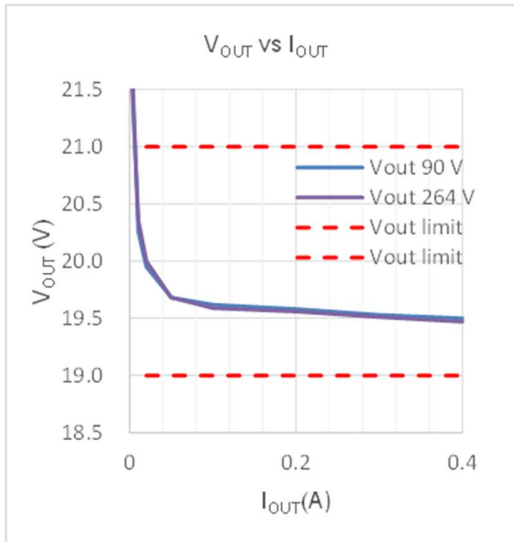

Figure 6. Load Regulation (V_{OUT} vs I_{OUT})

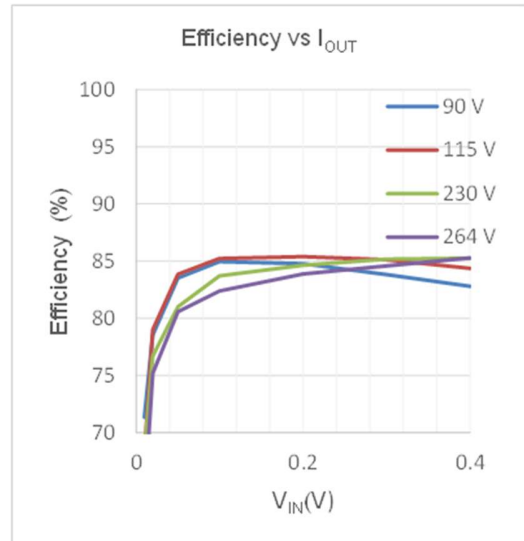

Figure 7. Load Regulation (Efficiency vs I_{OUT})

2 Line Regulation

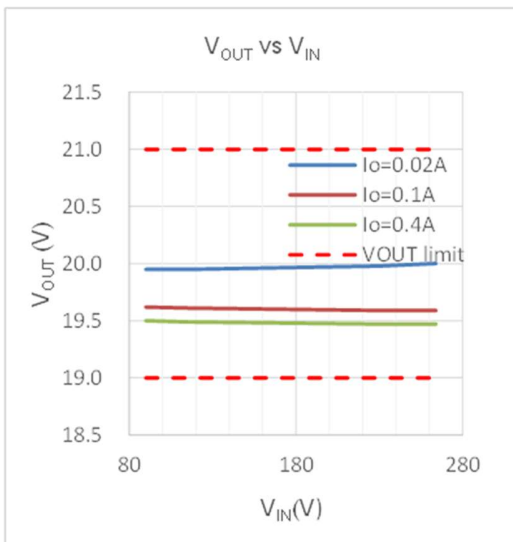

Figure 8. Line Regulation (V_{OUT} vs I_{OUT})

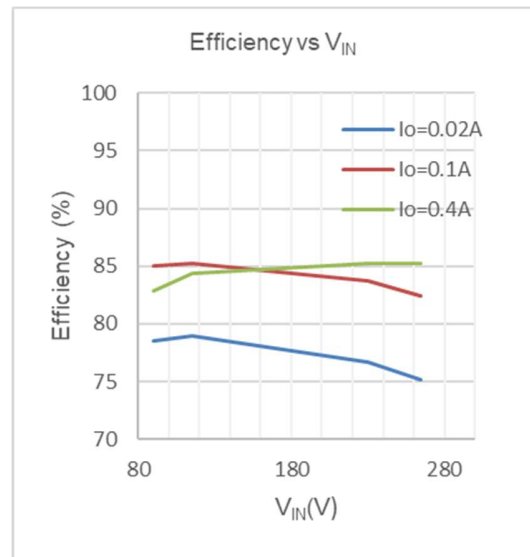

Figure 9. Line Regulation (Efficiency vs V_{IN})

Measurement Data – continued

3 Switching Wave Form

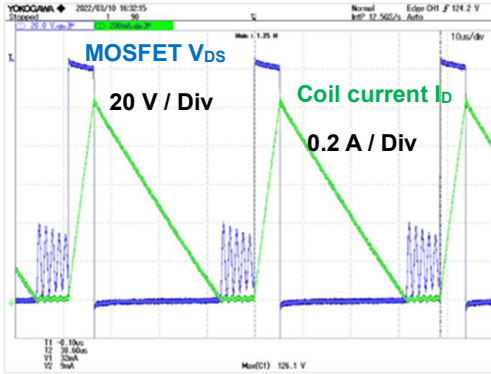

Figure 10. VDS, IL waveform $V_{IN}=90\text{ Vac}$, $I_{OUT}=0.4\text{ A}$

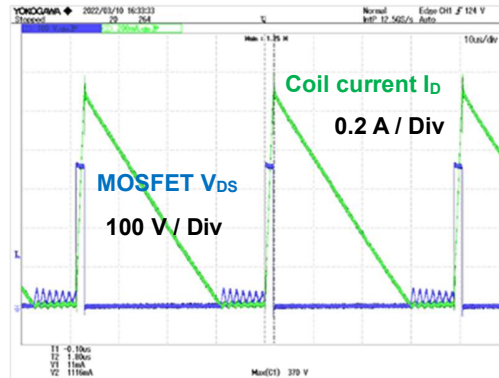

Figure 11. VDS, IL waveform $V_{IN}=264\text{ Vac}$, $I_{OUT}=0.4\text{ A}$

4 Startup Wave Form

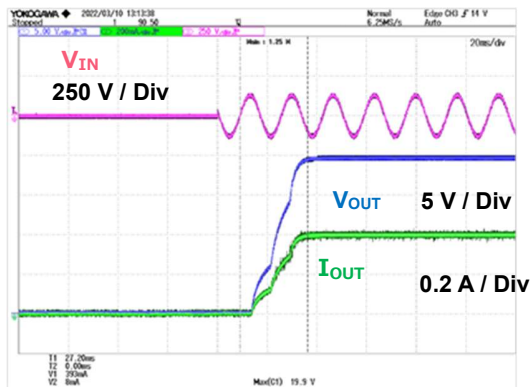

Figure 12. $V_{IN}=90\text{ Vac}$, $I_{OUT}=0.4\text{ A}$

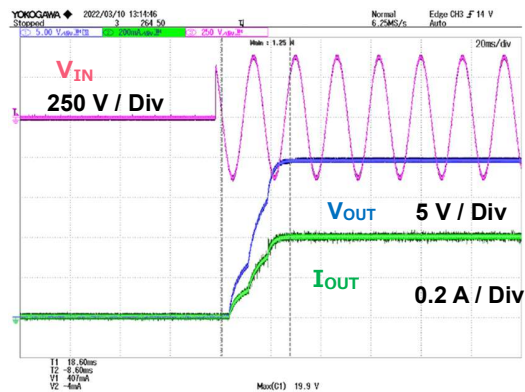

Figure 13. $V_{IN}=264\text{ Vac}$, $I_{OUT}=0.4\text{ A}$

Measurement Data - continued

5 Dynamic Load Fluctuation

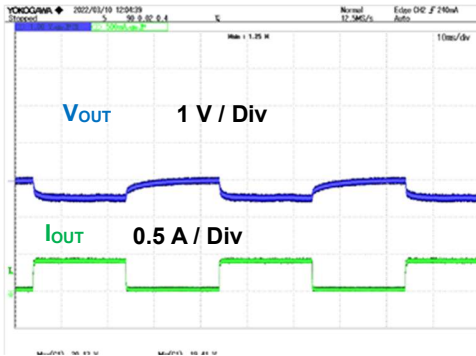

Figure 14. $V_{IN} = 90 \text{ Vac}$, $I_{OUT} = \text{switch } 0.02 \text{ A} / 0.4 \text{ A}$

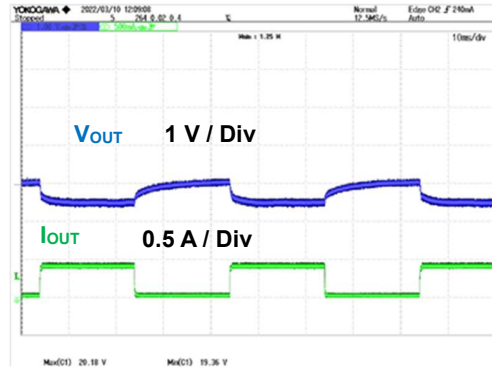

Figure 15. $V_{IN} = 264 \text{ Vac}$, $I_{OUT} = \text{switch } 0.02 \text{ A} / 0.4 \text{ A}$

6 Output Voltage Ripple Wave Form

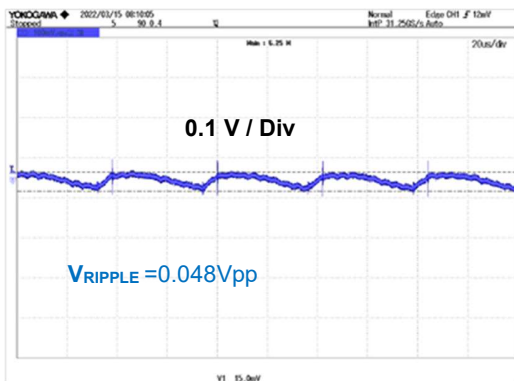

Figure 16. $V_{IN} = 90 \text{ Vac}$, $I_{OUT} = 0.4 \text{ A}$

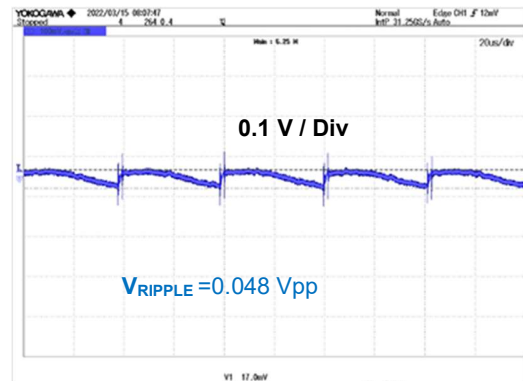

Figure 17. $V_{IN} = 264 \text{ Vac}$, $I_{OUT} = 0.4 \text{ A}$

Measurement Data - continued**7 Temperature of Parts Surface**

They are measured after 15 minutes from applying a power supply.

Table 2. Surface Temperature of Parts (Ta = 20 °C)

Part	Condition	
	V _{IN} = 90 Vac, I _{OUT} = 0.4 A	V _{IN} = 264 Vac, I _{OUT} = 0.4 A
IC1	47.6 °C	54.2 °C
Diode D2	61.6 °C	67.4 °C

Measurement Data – continued

8 EMI

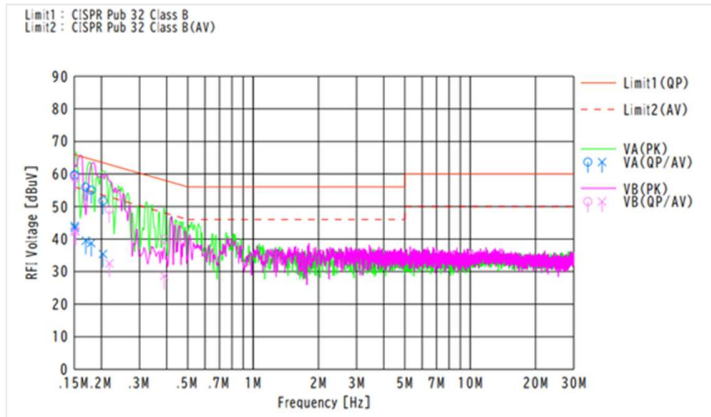

QP margin: 6.2 dB
AVE margin: 11.9 dB

Figure 18. V_{IN} : 115 Vac / 60 Hz, I_{OUT} : 0.4 A

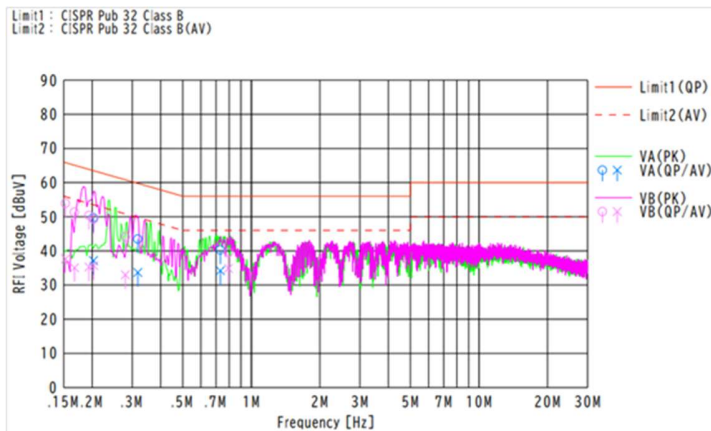

QP margin: 11.9 dB
AVE margin: 11.1 dB

Figure 19. V_{IN} : 230 Vac / 50 Hz, I_{OUT} : 0.4 A

Schematics

$V_{IN} = 90\text{ Vac} \sim 264\text{ Vac}$, $V_{OUT} = 20\text{ V } 0.4\text{ A}$

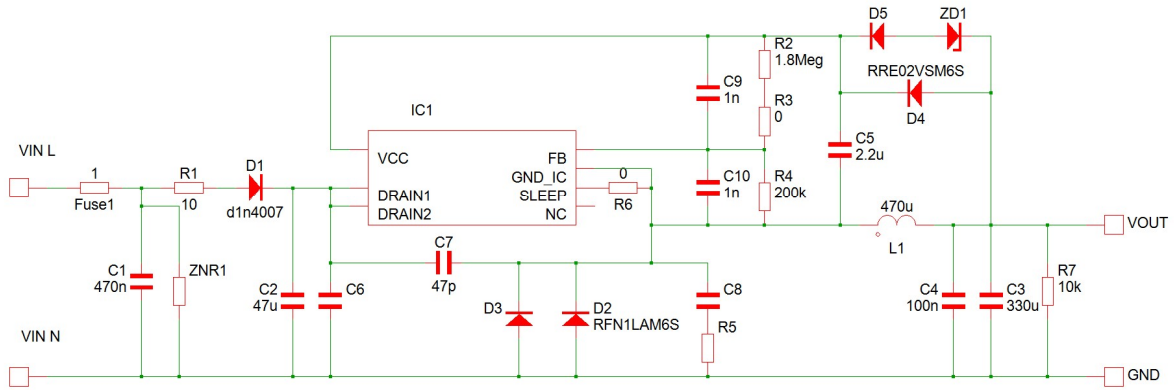

Figure 20. BM2PAB1Y-EVK-003 Schematics

Parts List

Table 3. BoM of BM2AB1Y-EVK-003

Item	Specifications	Parts name	Manufacture
C1	0.47 μ F, 310 V	890334025039CS	WURTH ELECTRONIK
C2	47 μ F, 450 V	450BXW47MEFR18X20	Rubycon
C3	330 μ F, 35 V	860040575009	WURTH ELECTRONIK
C4	0.1 μ F, 100 V	HMK107B7104MA-T	Taiyou yuden
C5	2.2 μ F, 50 V	UMK316B225KL-T	Taiyou yuden
C6	-	NON MOUNTED	
C7	47 pF, 630 V	GRM31A5C2J470W01D	MURATA
C8	-	NON MOUNTED	-
C9	1000 pF, 100 V	HMK107B7102KA-T	Taiyou yuden
C10	1000 pF, 100 V	HMK107B7102KA-T	Taiyou yuden
CN1	-	B02P-NV	JST
D1	1 A, 1000 V	1N4007	
D2	FRD, 0.8 A, 600 V	RFN1LAM6S	ROHM
D3	-	NON MOUNTED	
D4	0.2 A, 600 V	RRE02VSM6S	ROHM
D5	-	NON MOUNTED	
F1	1.0 A, 300 V	36911000000_	LITTELFUSE
IC1		BM2PAB1Y-Z	ROHM
L 1	470 μ H	RFS13170474KL	Coil Craft
R1	10 Ω 2W	PCF2C100K	KOA
R2	1.8 M Ω	MCR03EZPFX1804	ROHM
R3	0 Ω	MCR03EZPJ000	ROHM
R4	200 k Ω	MCR03EZPFX2003	ROHM
R5	-	NON MOUNTED	-
R6	0 Ω	MCR03EZPJ000	ROHM
R7	10 k Ω	MCR18EZPJ103	ROHM
TP1	RED	LC-22-G-RED	MAC8
TP2	BLACK	LC-2-G-BLACK	MAC8
ZD1	-	NON MOUNTED	
ZNR1		V470ZA05P	
	PCB	PCB0274A	

Materials may be changed without notifying.

Revision History

Date	Rev.	Changes
1.April.2022	001	New Release

Notes

- 1) The information contained herein is subject to change without notice.
- 2) Before you use our Products, please contact our sales representative and verify the latest specifications :
- 3) Although ROHM is continuously working to improve product reliability and quality, semiconductors can break down and malfunction due to various factors.
Therefore, in order to prevent personal injury or fire arising from failure, please take safety measures such as complying with the derating characteristics, implementing redundant and fire prevention designs, and utilizing backups and fail-safe procedures. ROHM shall have no responsibility for any damages arising out of the use of our Products beyond the rating specified by ROHM.
- 4) Examples of application circuits, circuit constants and any other information contained herein are provided only to illustrate the standard usage and operations of the Products. The peripheral conditions must be taken into account when designing circuits for mass production.
- 5) The technical information specified herein is intended only to show the typical functions of and examples of application circuits for the Products. ROHM does not grant you, explicitly or implicitly, any license to use or exercise intellectual property or other rights held by ROHM or any other parties. ROHM shall have no responsibility whatsoever for any dispute arising out of the use of such technical information.
- 6) The Products specified in this document are not designed to be radiation tolerant.
- 7) For use of our Products in applications requiring a high degree of reliability (as exemplified below), please contact and consult with a ROHM representative : transportation equipment (i.e. cars, ships, trains), primary communication equipment, traffic lights, fire/crime prevention, safety equipment, medical systems, servers, solar cells, and power transmission systems.
- 8) Do not use our Products in applications requiring extremely high reliability, such as aerospace equipment, nuclear power control systems, and submarine repeaters.
- 9) ROHM shall have no responsibility for any damages or injury arising from non-compliance with the recommended usage conditions and specifications contained herein.
- 10) ROHM has used reasonable care to ensure the accuracy of the information contained in this document. However, ROHM does not warrants that such information is error-free, and ROHM shall have no responsibility for any damages arising from any inaccuracy or misprint of such information.
- 11) Please use the Products in accordance with any applicable environmental laws and regulations, such as the RoHS Directive. For more details, including RoHS compatibility, please contact a ROHM sales office. ROHM shall have no responsibility for any damages or losses resulting non-compliance with any applicable laws or regulations.
- 12) When providing our Products and technologies contained in this document to other countries, you must abide by the procedures and provisions stipulated in all applicable export laws and regulations, including without limitation the US Export Administration Regulations and the Foreign Exchange and Foreign Trade Act.
- 13) This document, in part or in whole, may not be reprinted or reproduced without prior consent of ROHM.



Thank you for your accessing to ROHM product informations.
More detail product informations and catalogs are available, please contact us.

ROHM Customer Support System

<http://www.rohm.com/contact/>