

REVISIONS			
REV	DESCRIPTION	DATE	APPROVED

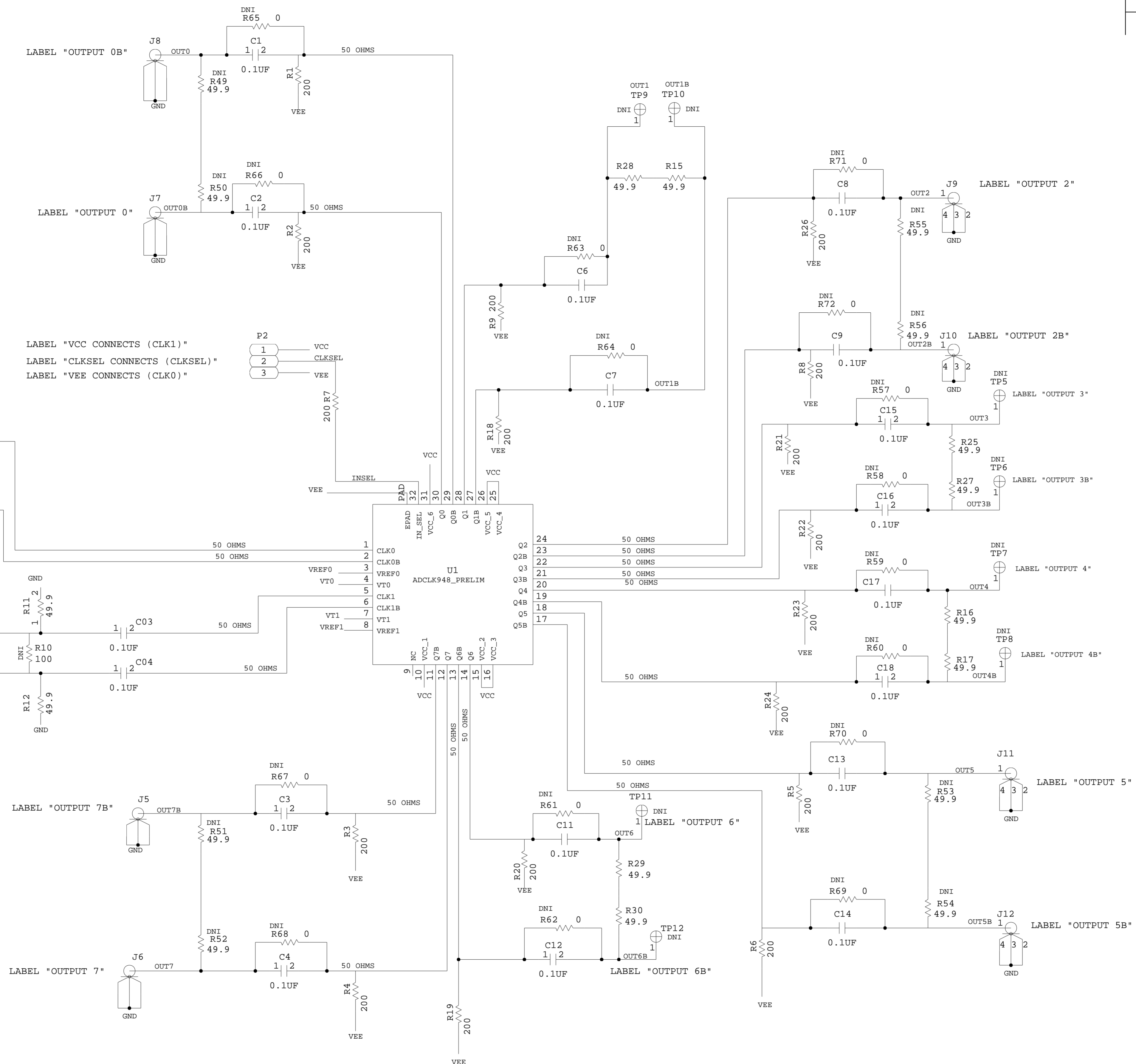

LABEL "VCC CONNECTS (CLK1)"
 LABEL "CLKSEL CONNECTS (CLKSEL)"
 LABEL "VEE CONNECTS (CLK0)"

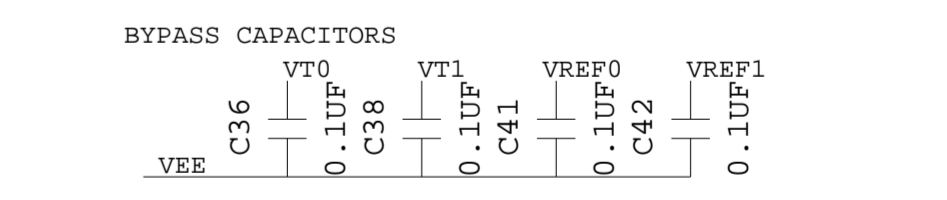
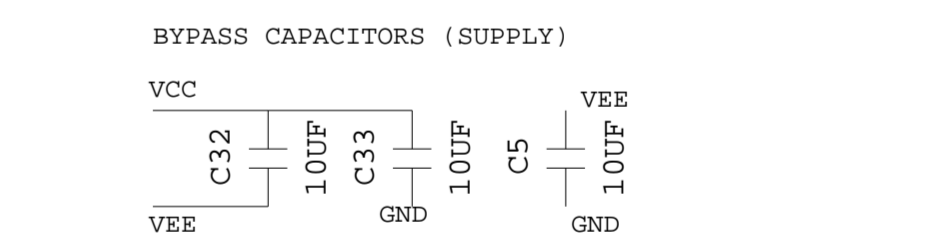
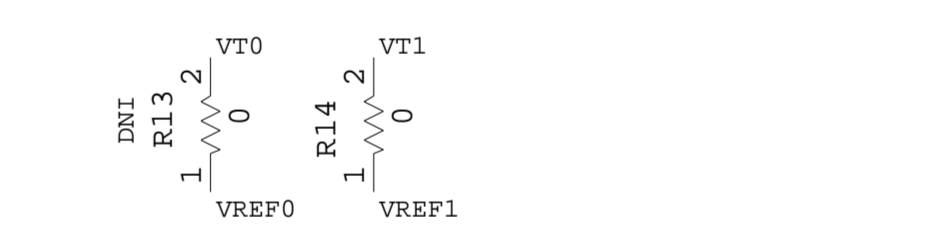
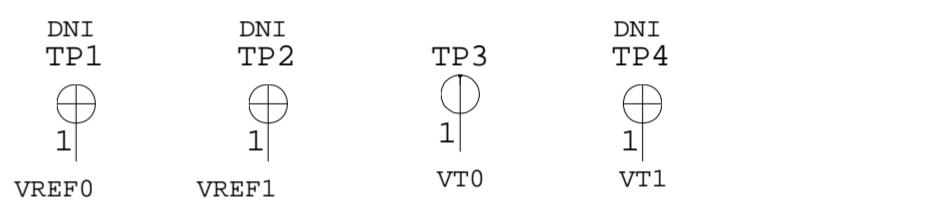
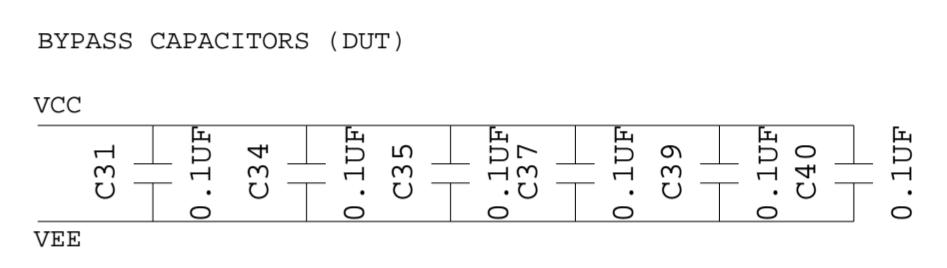
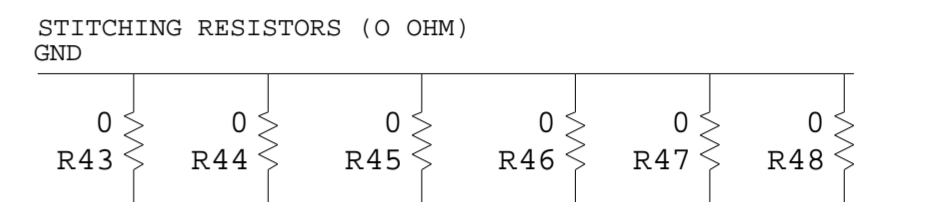
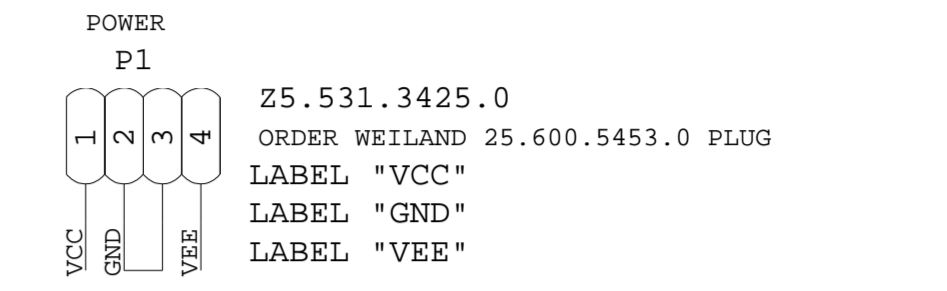

SCHEMATIC			
SCHEMATIC DRAWING			
Customer Evaluation Board			
DESIGN VIEW	DRAWING NO.	REV	
04/29/2009	SCH-ADCLK948CE01	C	
PTD ENGINEER	SIZE	SCALE	
MARK STOEHHR	D	NONE	
	SHEET 1	OF 1	

ANALOG DEVICES
THIS DRAWING IS THE PROPERTY OF ANALOG DEVICES INC. IT IS TO BE USED FOR IDENTIFICATION OR COPIED, IN WHOLE OR IN PART, OR USED IN PROMOTIONAL INFORMATION TO OTHERS, OR FOR ANY OTHER PURPOSE DETRIMENTAL TO THE INTERESTS OF ANALOG DEVICES. THIS EQUIPMENT DESIGN HEREON MAY BE PROTECTED BY PATENTS OWNED OR CONTROLLED BY ANALOG DEVICES INC.