

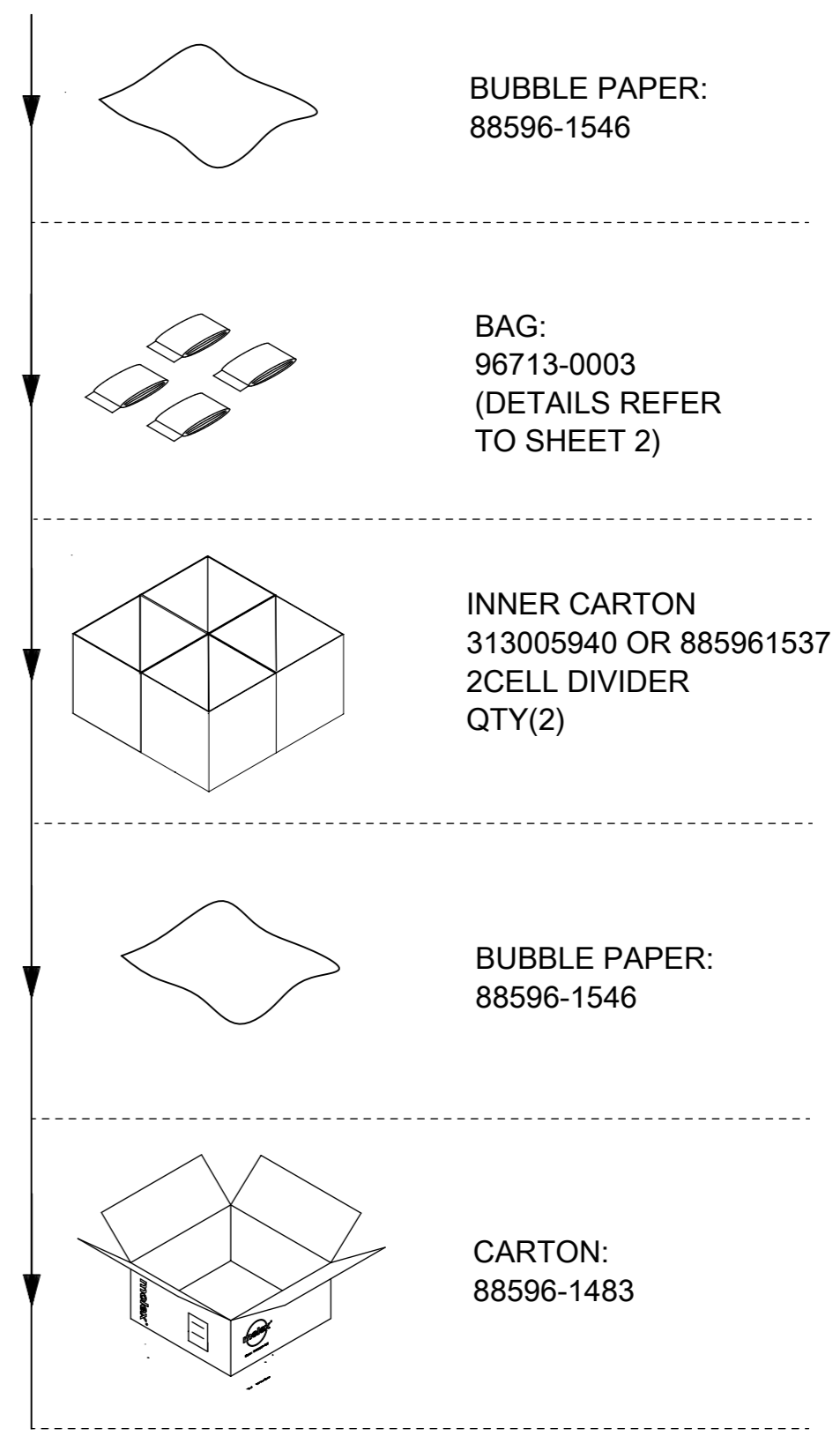

PART NUMBER	CKTS	QUANTITY PER BAG	BAGS PER CARTON	PARTS PER CARTON (SPQ)	MOISTURIZATION METHOD 	PANEL LOCK
215922-0201	2	3000	4	12000	NO MOISTURIZATION	WITHOUT
215922-0401	4	2600	4	10400		
215922-0601	6	2000	4	8000		
215922-0801	8	1700	4	6800		
215922-1001	10	1400	4	5600		
215922-1201	12	1000	4	4000		
215922-1401	14	800	4	3200		
215922-1601	16	800	4	3200		
215922-1801	18	600	4	2400		
215922-2001	20	600	4	2400		
215922-2201	22	600	4	2400		
215922-2401	24	450	4	1800		
215922-0200	2	2000	4	8000	SEE SHEET 2	WITH
215922-0400	4	1800	4	7200		
215922-0600	6	1600	4	6400		
215922-0800	8	1100	4	4400		
215922-1000	10	1000	4	4000		
215922-1200	12	900	4	3600		
215922-1400	14	800	4	3200		
215922-1600	16	700	4	2800		
215922-1800	18	600	4	2400		
215922-2000	20	600	4	2400		
215922-2200	22	400	4	1600		
215922-2400	24	350	4	1400		



TBD: NO PRODUCTION, TO BE ADDED AFTER BEING PRODUCED.

- NOTES:
-  MOISTURIZATION METHOD DESCRIPTIONS REFER TO SHEET 2.
 - STANDARD PACKAGE QUANTITY (SPQ) SEE ABOVE CHART.
 - PACKAGE WAY FOLLOW RIGHT ILLUSTRATION.
 - ALL PACKAGE MATERIAL AND PRODUCT COMPLIANT TO RoHS DIRECTIVE 2011/65/EU AND ELV DIRECTIVE 2000/53/EC.

FUNCTIONAL SYMBOLS	THIS DRAWING CONTAINS INFORMATION THAT IS PROPRIETARY TO MOLEX ELECTRONIC TECHNOLOGIES, LLC AND SHOULD NOT BE USED WITHOUT WRITTEN PERMISSION		 PACKING SPEC FOR MICRO-FIT PLUS WTW HSG		
	DIMENSION UNITS: mm SCALE: 1:1	CURRENT REV DESC:			
DIVISIONAL SYMBOLS	GENERAL TOLERANCES (UNLESS SPECIFIED)		DRWN: GLLI 2022/10/31		
	ANGULAR TOL ± °		CHK'D: XQZHANG 2022/10/31		
	4 PLACES ±		APPR: XQZHANG 2022/10/31		
	3 PLACES ± 0.1		INITIAL REVISION:		
	2 PLACES ± 0.3		DRWN: GLLI 2021/10/28		
1 PLACE ± 0.5		APPR: XQZHANG 2021/11/15			
0 PLACES ±		DOCUMENT NUMBER: 2159220000-PK			
DRAFT WHERE APPLICABLE MUST REMAIN WITHIN DIMENSIONS		THIRD ANGLE PROJECTION	DRAWING: A3-SIZE	SERIES: 215922	CUSTOMER: PSD 000 B
		MATERIAL NUMBER		SHEET NUMBER: 1 OF 2	

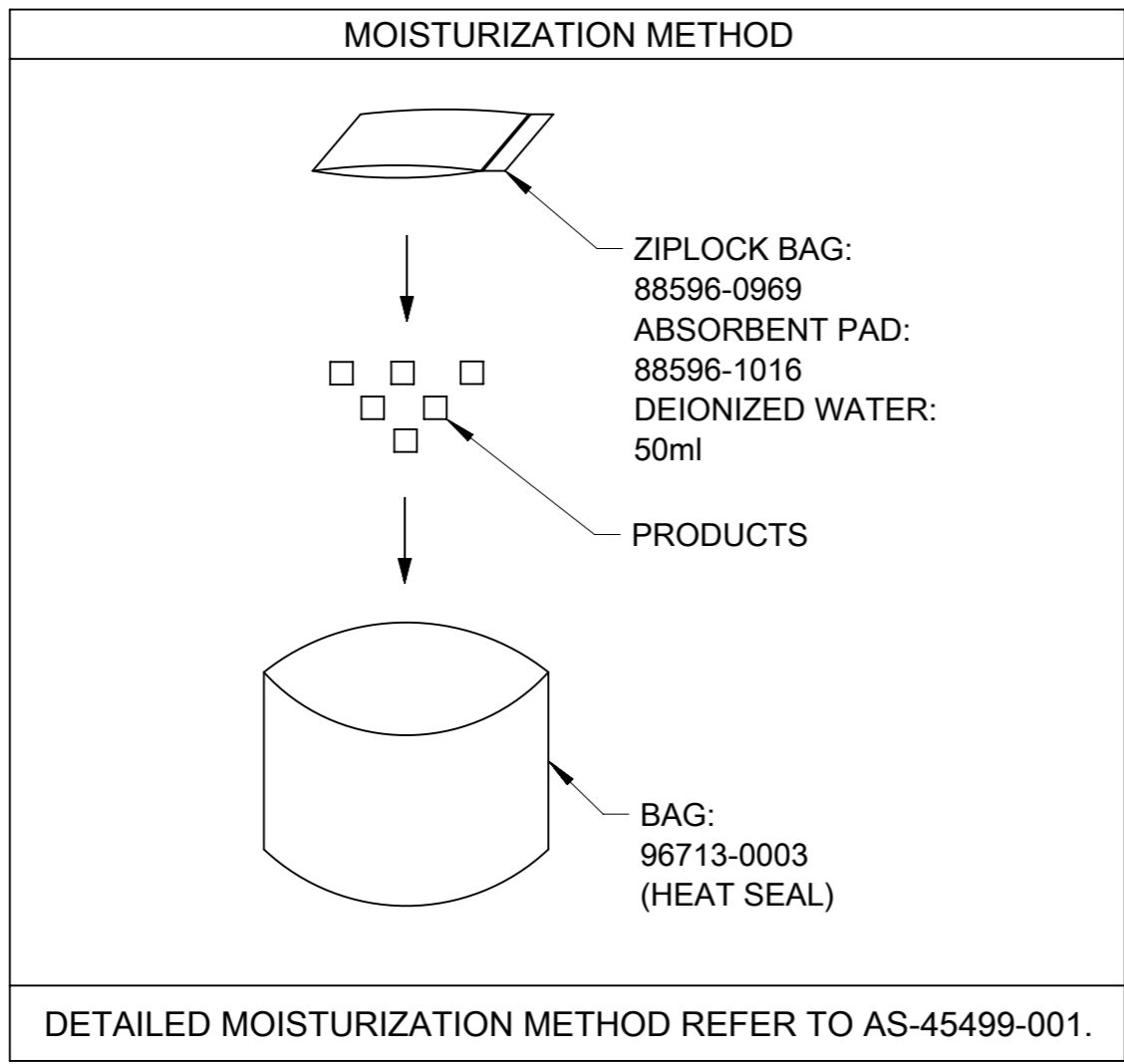

THIS DRAWING CONTAINS INFORMATION THAT IS PROPRIETARY TO MOLEX ELECTRONIC TECHNOLOGIES, LLC AND SHOULD NOT BE USED WITHOUT WRITTEN PERMISSION																	
FUNCTIONAL SYMBOLS	△/A = 0	mm	SCALE 1:1	CURRENT REV DESC:			molex										
	△/E = 0	GENERAL TOLERANCES (UNLESS SPECIFIED)									EC NO: 725570 DRWN: GLLI 2022/08/29 CHK'D: XQZHANG 2022/10/31 APPR: XQZHANG 2022/10/31			PACKING SPEC FOR MICRO-FIT PLUS WTW HSG			
	△/P = 0	ANGULAR TOL ± °												PRODUCT CUSTOMER DRAWING			
DIVISIONAL SYMBOLS	4 PLACES ±		INITIAL REVISION:		DOCUMENT NUMBER		DOC TYPE	DOC PART	REVISION								
	3 PLACES ± 0.1		DRWN: GLLI 2021/10/28		2159220000-PK		PSD	000	B								
	2 PLACES ± 0.3		APPR: XQZHANG 2021/11/15		MATERIAL NUMBER		CUSTOMER		SHEET NUMBER								
	1 PLACE ± 0.5		DRAFT WHERE APPLICABLE MUST REMAIN WITHIN DIMENSIONS		THIRD ANGLE PROJECTION	DRAWING	SERIES										
	0 PLACES ±		A3-SIZE		215922			2 OF 2									

FREE HANGING PLUG PARTS

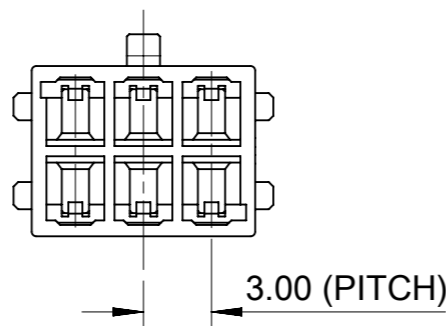
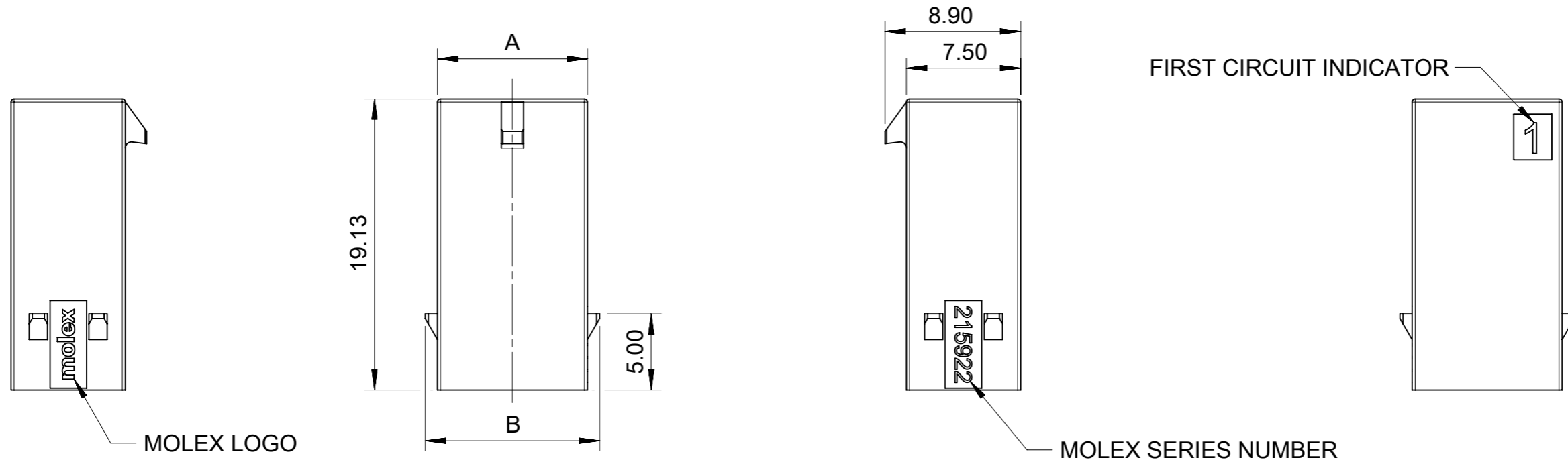

PART No	DIM'A'	DIM'B'	CKT SIZE
215922-0201	3.85	5.45	2
215922-0401	6.85	8.45	4
215922-0601	9.85	11.45	6
215922-0801	12.85	14.45	8
215922-1001	15.85	17.45	10
215922-1201	18.85	20.45	12
215922-1401	21.85	23.45	14
215922-1601	24.85	26.45	16
215922-1801	27.85	29.45	18
215922-2001	30.85	32.45	20
215922-2201	33.85	35.45	22
215922-2401	36.85	38.45	24

- NOTES:
1. MATERIAL: PA66, 94V-0, BLACK.
 2. PRODUCT SPECIFICATION: 2159530000-PS.
 3. PACKAGE SPECIFICATION: 2159220000-PK.
 4. TO USE WITH TERMINAL OF 2015953-****.
 5. TO USE WITH TPA OF 206462-****.
 6. TO MATE WITH RECEPTACLE OF 206461-****.
 7. PARTS CONFORM TO CLASS 'B' REQUIREMENTS OF COSMETIC SPECIFICATION PS-45499-002.

FUNCTIONAL SYMBOLS	THIS DRAWING CONTAINS INFORMATION THAT IS PROPRIETARY TO MOLEX ELECTRONIC TECHNOLOGIES, LLC AND SHOULD NOT BE USED WITHOUT WRITTEN PERMISSION		CURRENT REV DESC:					
	$\nabla_A = 0$ $\nabla_E = 0$ $\nabla_F = 0$	DIMENSION UNITS: mm SCALE: 1:1						
DIVISIONAL SYMBOLS	4 PLACES ±	EC NO: 712744 DRWN: GLLI CHK'D: XQZHANG APPR: XQZHANG	2022/07/01 2022/07/05 2022/07/05		PLUG HOUSING OF MICRO-FIT PLUS WTW DR POWER CONNECTOR PRODUCT CUSTOMER DRAWING			
	3 PLACES ±		INITIAL REVISION: DRWN: GLLI APPR: XQZHANG					
	2 PLACES ± 0.2		2021/01/29 2021/11/15		MATERIAL NUMBER CUSTOMER GENERAL MARKET		SHEET NUMBER 1 OF 6	
	1 PLACE ± 0.3		DRAFT WHERE APPLICABLE MUST REMAIN WITHIN DIMENSIONS THIRD ANGLE PROJECTION 		DRAWING A3-SIZE	SERIES 215922		

FREE HANGING PLUG PARTS

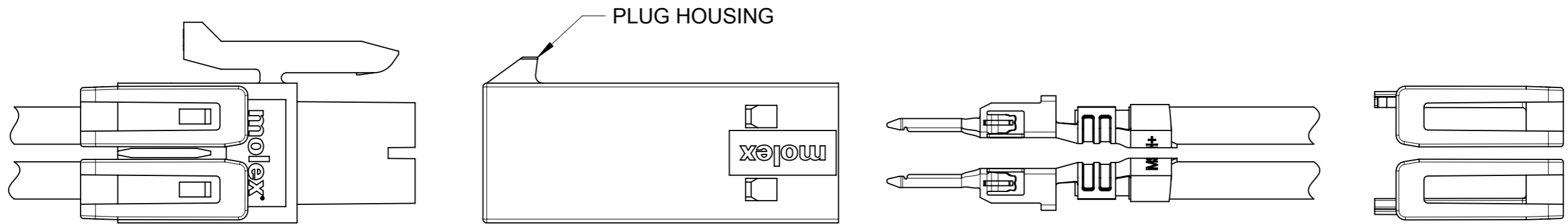
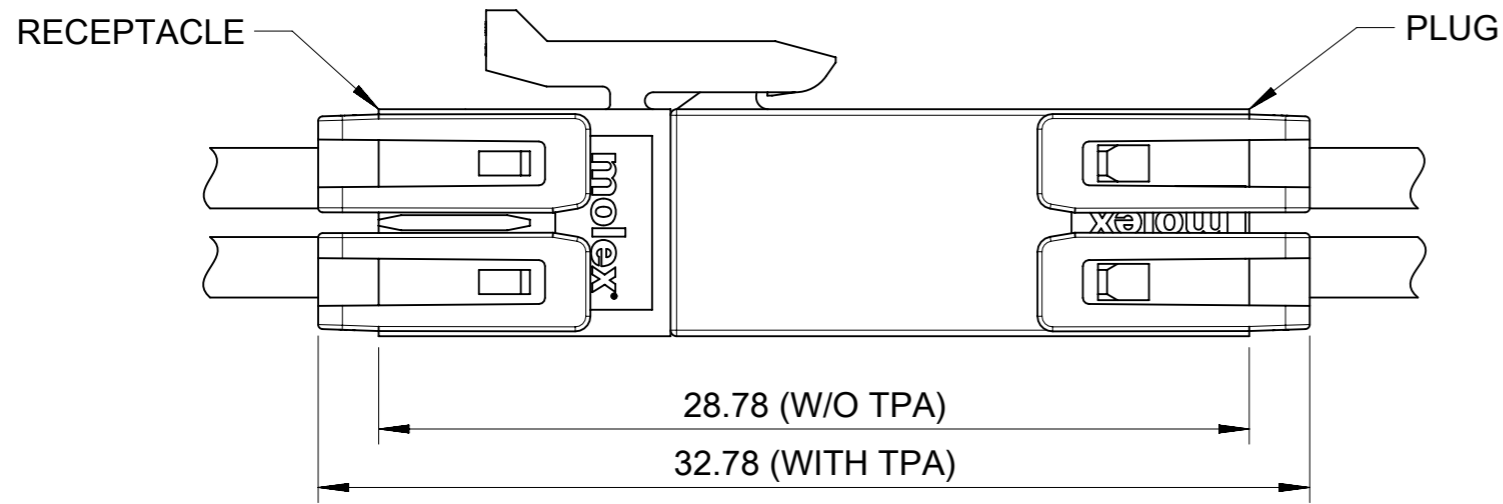

TERMINAL AND TPA ORIENTATION

FUNCTIONAL SYMBOLS	THIS DRAWING CONTAINS INFORMATION THAT IS PROPRIETARY TO MOLEX ELECTRONIC TECHNOLOGIES, LLC AND SHOULD NOT BE USED WITHOUT WRITTEN PERMISSION		CURRENT REV DESC:		molex				
	FA = 0	mm						SCALE 1:1	
DIVISIONAL SYMBOLS	GENERAL TOLERANCES (UNLESS SPECIFIED)		EC NO: 712744 DRWN: GLLI 2022/07/01 CHK'D: XQZHANG 2022/07/05 APPR: XQZHANG 2022/07/05		PLUG HOUSING OF MICRO-FIT PLUS WTW DR POWER CONNECTOR				
	ANGULAR TOL ± °				PRODUCT CUSTOMER DRAWING				
	4 PLACES ±				DOCUMENT NUMBER		DOC TYPE	DOC PART	REVISION
	3 PLACES ±				2159220000-SD		PSD	000	A1
	2 PLACES ± 0.2				MATERIAL NUMBER		CUSTOMER		SHEET NUMBER
1 PLACE ± 0.3		DRWN: GLLI 2021/01/29 APPR: XQZHANG 2021/11/15		GENERAL MARKET		2 OF 6			
0 PLACES ±		DRAFT WHERE APPLICABLE MUST REMAIN WITHIN DIMENSIONS		THIRD ANGLE PROJECTION	DRAWING	SERIES			
				⊕	A3-SIZE	215922			

FREE HANGING PLUG PARTS

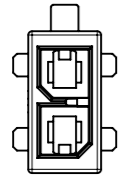

2 CKT

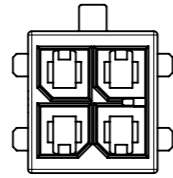

4 CKT

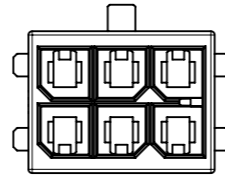

6 CKT

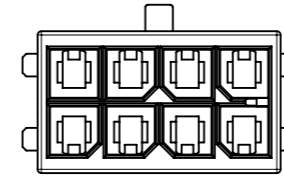

8 CKT

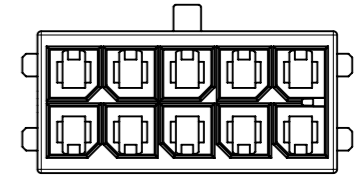

10 CKT

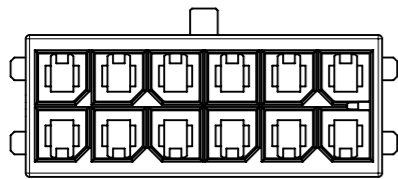

12 CKT

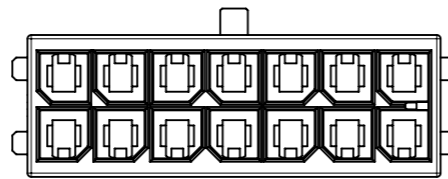

14 CKT

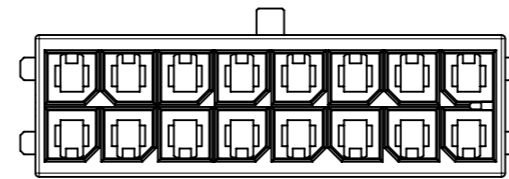

16 CKT

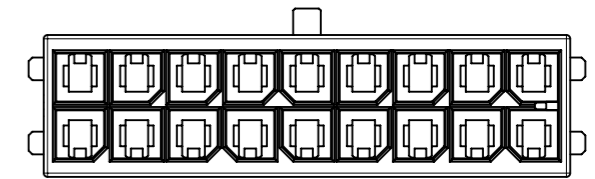

18 CKT

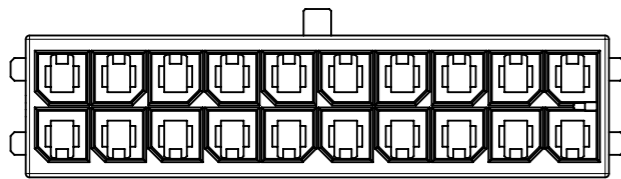

20 CKT

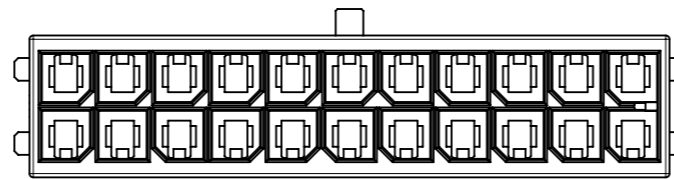

22 CKT

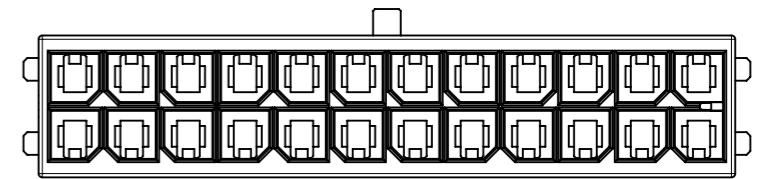

24 CKT

FUNCTIONAL SYMBOLS	THIS DRAWING CONTAINS INFORMATION THAT IS PROPRIETARY TO MOLEX ELECTRONIC TECHNOLOGIES, LLC AND SHOULD NOT BE USED WITHOUT WRITTEN PERMISSION		CURRENT REV DESC:		molex				
	4 PLACES	±							°
GENERAL TOLERANCES (UNLESS SPECIFIED)	mm		1:1	DRWN: GLLI	2022/07/05	PRODUCT CUSTOMER DRAWING			
ANGULAR TOL	±	°		CHK'D: XQZHANG	2022/07/05	DOCUMENT NUMBER			
3 PLACES	±			APPR: XQZHANG	2022/07/05	2159220000-SD	PSD	000	A1
2 PLACES	±	0.2		INITIAL REVISION:		MATERIAL NUMBER		CUSTOMER	SHEET NUMBER
1 PLACE	±	0.3		DRWN: GLLI	2021/01/29	215922		GENERAL MARKET	3 OF 6
0 PLACES	±			APPR: XQZHANG	2021/11/15				
DRAFT WHERE APPLICABLE MUST REMAIN WITHIN DIMENSIONS	THIRD ANGLE PROJECTION		DRAWING	SERIES	MATERIAL NUMBER		CUSTOMER		SHEET NUMBER
			A3-SIZE	215922	215922		GENERAL MARKET		3 OF 6

PANEL MOUNT PLUG PARTS

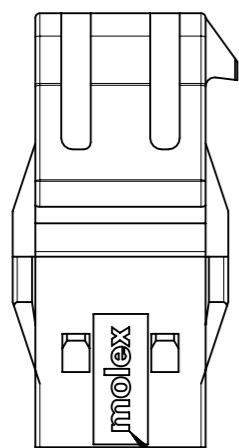

MOLEX LOGO

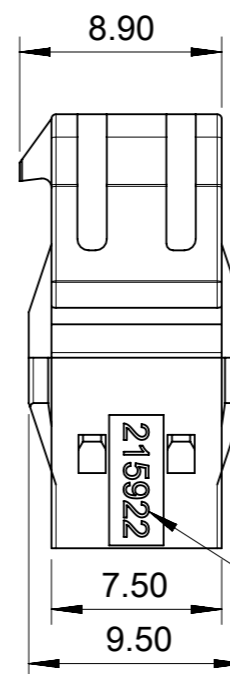
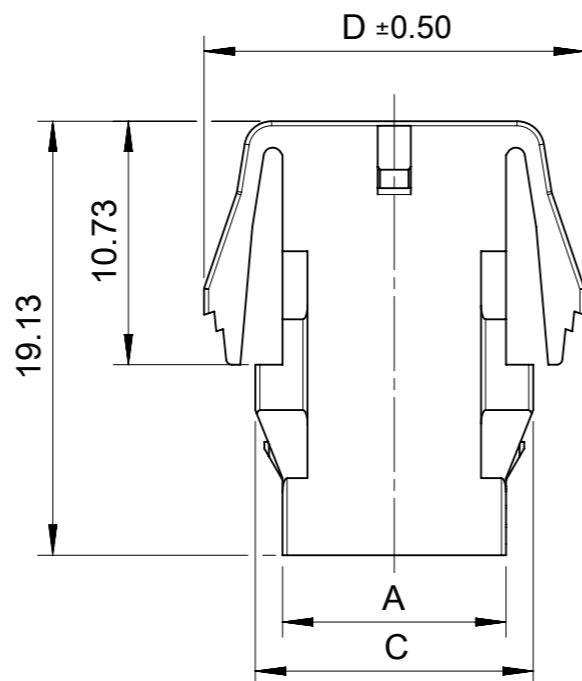

FIRST CIRCUIT INDICATOR

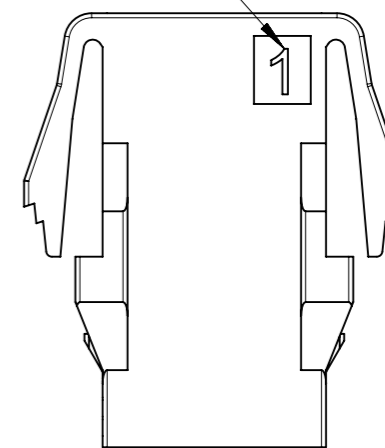

MOLEX SERIES NUMBER

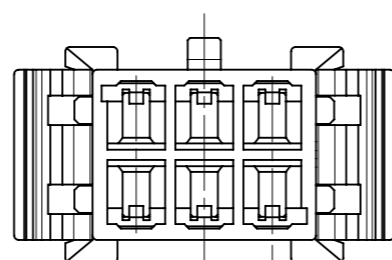

3.00 (PITCH)

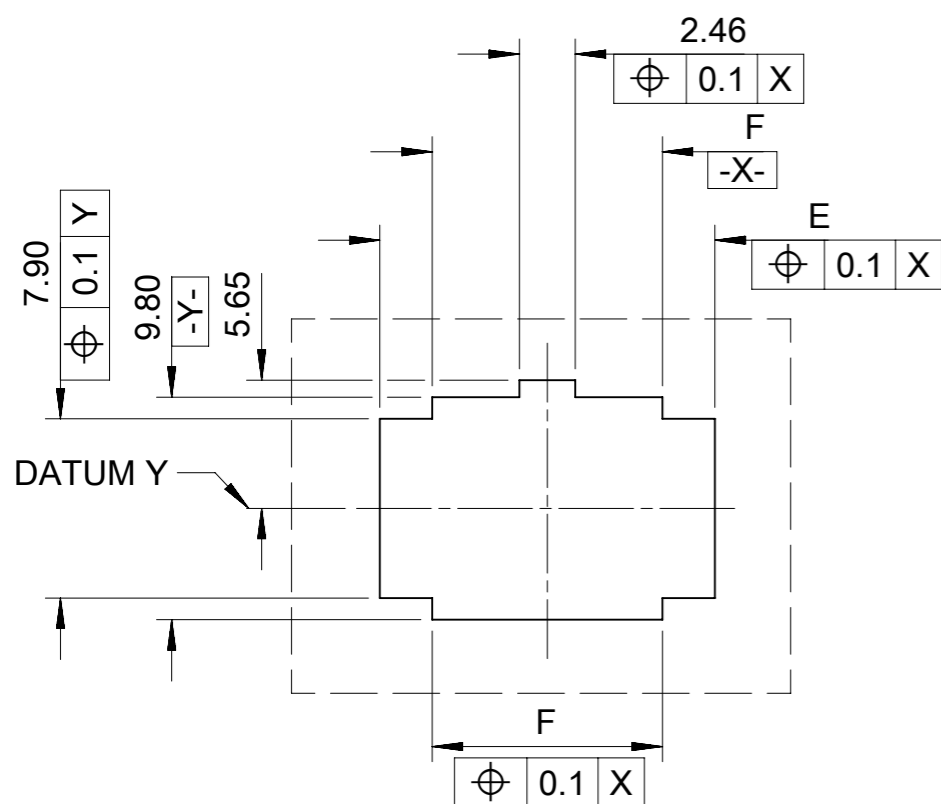

PART No	DIM 'A'	DIM 'C'	DIM 'D'	DIM 'E'	DIM 'F'	CKT SIZE
215922-0200	3.85	6.25	10.77	8.77	4.15	2
215922-0400	6.85	9.25	13.77	11.77	7.15	4
215922-0600	9.85	12.25	16.77	14.77	10.15	6
215922-0800	12.85	15.25	19.77	17.77	13.15	8
215922-1000	15.85	18.25	22.77	20.77	16.15	10
215922-1200	18.85	21.25	25.77	23.77	19.15	12
215922-1400	21.85	24.25	28.77	26.77	22.15	14
215922-1600	24.85	27.25	31.77	29.77	25.15	16
215922-1800	27.85	30.25	34.77	32.77	28.15	18
215922-2000	30.85	33.25	37.77	35.77	31.15	20
215922-2200	33.85	36.25	40.77	38.77	34.15	22
215922-2400	36.85	39.25	43.77	41.77	37.15	24

RECOMMENDED PANEL CUT OUT
(TOLERRANCE +/-0.05 THICKNESS=1.2~2.2MM)

FUNCTIONAL SYMBOLS	THIS DRAWING CONTAINS INFORMATION THAT IS PROPRIETARY TO MOLEX ELECTRONIC TECHNOLOGIES, LLC AND SHOULD NOT BE USED WITHOUT WRITTEN PERMISSION	CURRENT REV DESC:						
	DIMENSION UNITS: mm SCALE: 1:1 GENERAL TOLERANCES (UNLESS SPECIFIED): ANGULAR TOL ± ° 4 PLACES ± 3 PLACES ± 2 PLACES ± 0.2 1 PLACE ± 0.3 0 PLACES ±	EC NO: 712744 DRWN: GLLI CHK'D: XQZHANG APPR: XQZHANG						2022/07/01 2022/07/05 2022/07/05
DIVISIONAL SYMBOLS	DRAFT WHERE APPLICABLE MUST REMAIN WITHIN DIMENSIONS		THIRD ANGLE PROJECTION	DRAWING: A3-SIZE	SERIES: 215922	MATERIAL NUMBER:	CUSTOMER: GENERAL MARKET	SHEET NUMBER: 4 OF 6
	PRODUCT CUSTOMER DRAWING		DOCUMENT NUMBER: 2159220000-SD		DOC TYPE: PSD	DOC PART: 000	REVISION: A1	

PANEL MOUNT PLUG PARTS

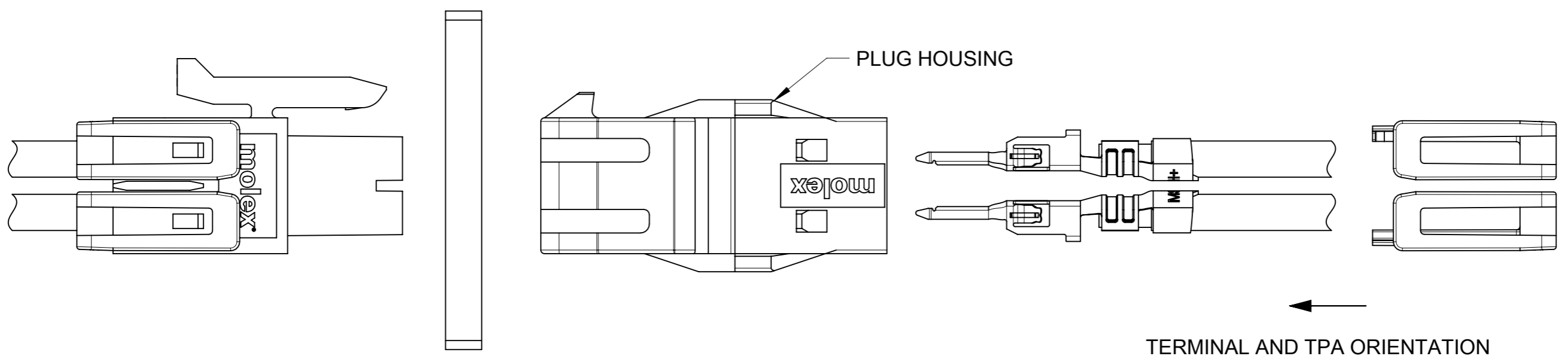
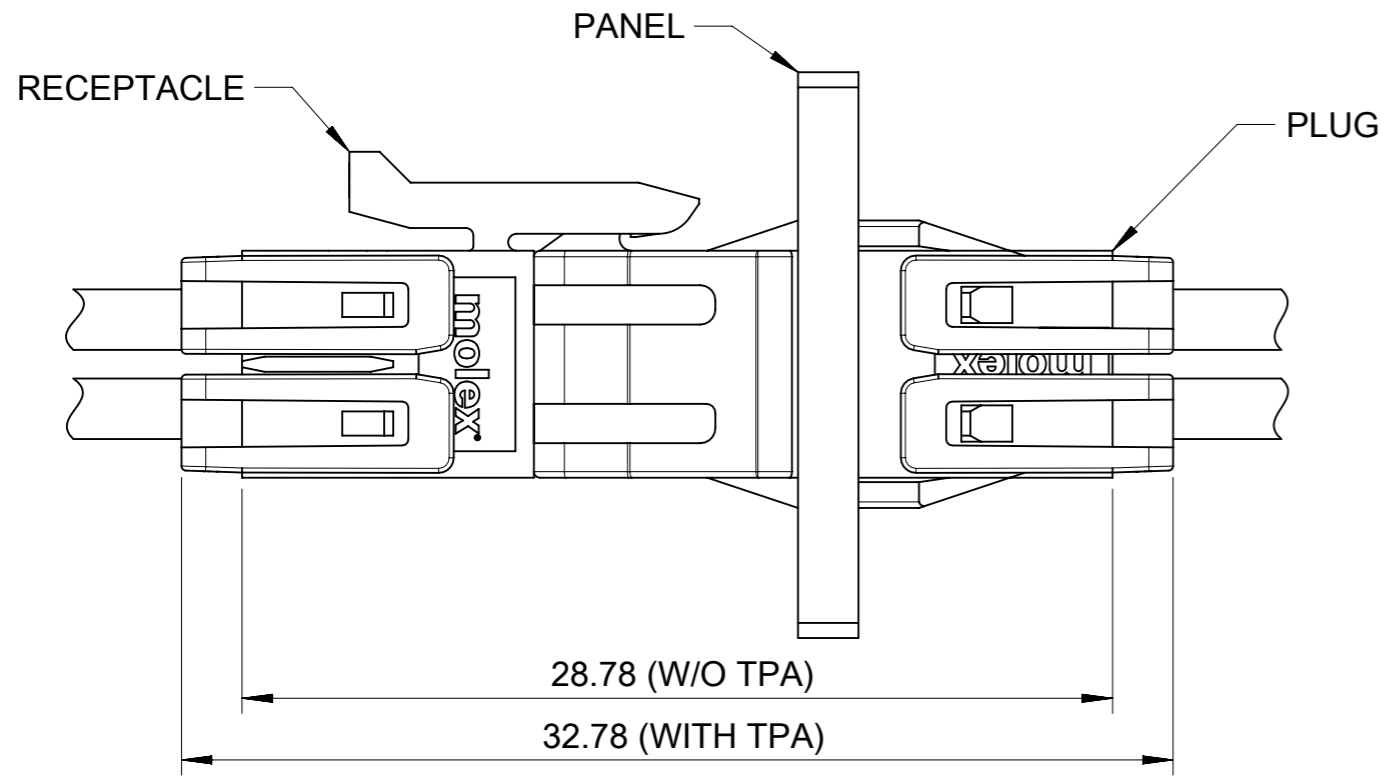

FUNCTIONAL SYMBOLS	THIS DRAWING CONTAINS INFORMATION THAT IS PROPRIETARY TO MOLEX ELECTRONIC TECHNOLOGIES, LLC AND SHOULD NOT BE USED WITHOUT WRITTEN PERMISSION		CURRENT REV DESC:		molex					
	▽A = 0	mm							SCALE 1:1	
▽E = 0	GENERAL TOLERANCES (UNLESS SPECIFIED)		EC NO: 712744 DRWN: GLLI 2022/07/01 CHK'D: XQZHANG 2022/07/05 APPR: XQZHANG 2022/07/05		PLUG HOUSING OF MICRO-FIT PLUS WTW DR POWER CONNECTOR					
▽P = 0	ANGULAR TOL ± °				PRODUCT CUSTOMER DRAWING					
DIVISIONAL SYMBOLS	4 PLACES ±				INITIAL REVISION:		DOCUMENT NUMBER	DOC TYPE	DOC PART	REVISION
	3 PLACES ±				DRWN: GLLI 2021/01/29		2159220000-SD	PSD	000	A1
	2 PLACES ±	0.2	APPR: XQZHANG 2021/11/15		MATERIAL NUMBER		CUSTOMER			
	1 PLACE ±	0.3	DRAFT WHERE APPLICABLE MUST REMAIN WITHIN DIMENSIONS		SERIES		SHEET NUMBER			
	0 PLACES ±		THIRD ANGLE PROJECTION		A3-SIZE		215922			
			DRAWING		GENERAL MARKET		5 OF 6			

PANEL MOUNT PLUG PARTS

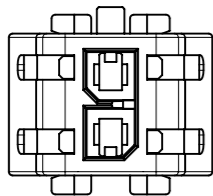

2 CKT

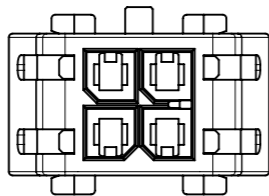

4 CKT

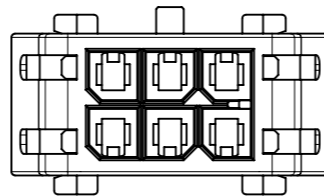

6 CKT

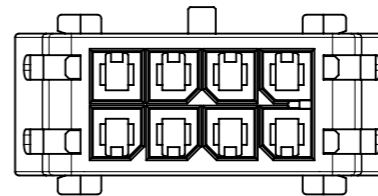

8 CKT

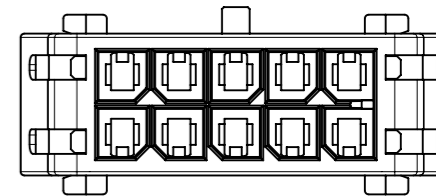

10 CKT

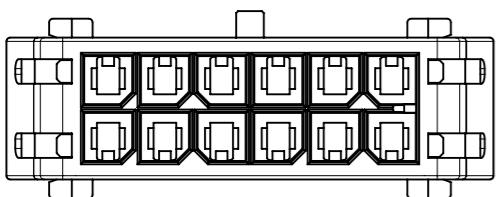

12 CKT

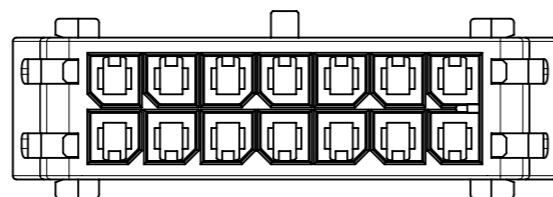

14 CKT

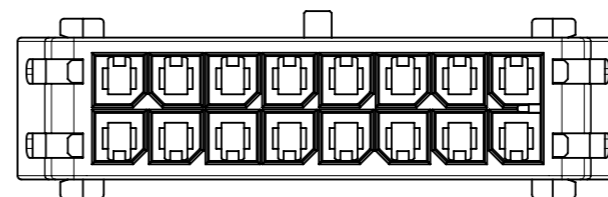

16 CKT

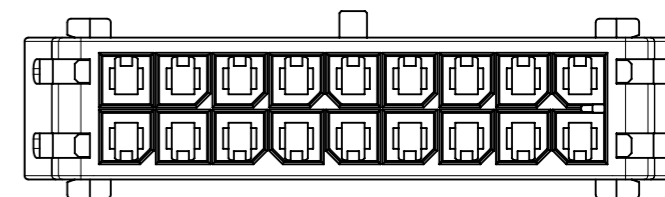

18 CKT

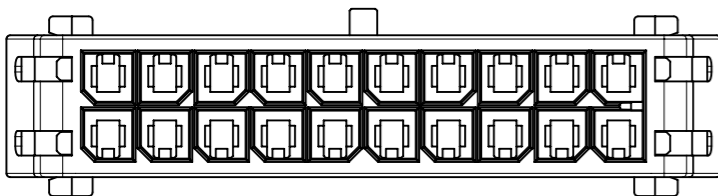

20 CKT

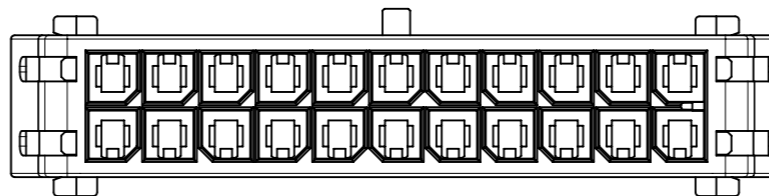

22 CKT

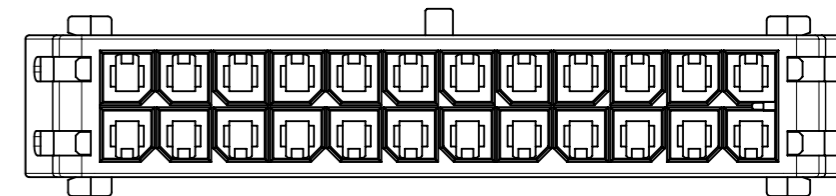

24 CKT

FUNCTIONAL SYMBOLS	THIS DRAWING CONTAINS INFORMATION THAT IS PROPRIETARY TO MOLEX ELECTRONIC TECHNOLOGIES, LLC AND SHOULD NOT BE USED WITHOUT WRITTEN PERMISSION		<div style="text-align: center; font-weight: bold; font-size: 1.2em;">molex</div> <p>PLUG HOUSING OF MICRO-FIT PLUS WTW DR POWER CONNECTOR</p>				
	$\nabla_A = 0$ $\nabla_E = 0$ $\nabla_V = 0$	DIMENSION UNITS: mm SCALE: 1:1 GENERAL TOLERANCES (UNLESS SPECIFIED) ANGULAR TOL ± °					CURRENT REV DESC: EC NO: 712744 DRWN: GLLI CHK'D: XQZHANG APPR: XQZHANG
DIVISIONAL SYMBOLS	4 PLACES ± 3 PLACES ± 2 PLACES ± 0.2 1 PLACE ± 0.3 0 PLACES ±	INITIAL REVISION: DRWN: GLLI APPR: XQZHANG	2021/01/29 2021/11/15	DOCUMENT NUMBER <div style="font-size: 1.1em; font-weight: bold;">2159220000-SD</div>	DOC TYPE PSD	DOC PART 000	REVISION <div style="font-size: 1.1em; font-weight: bold;">A1</div>
	DRAFT WHERE APPLICABLE MUST REMAIN WITHIN DIMENSIONS	THIRD ANGLE PROJECTION 	DRAWING A3-SIZE	SERIES 215922	MATERIAL NUMBER CUSTOMER GENERAL MARKET	SHEET NUMBER 6 OF 6	