

# XS4P08PA370L1

Inductive proximity sensors XS, inductive sensor XS4 M8, L50mm, PPS, Sn2.5 mm, 12...48 VDC, cable 5 m



## Main

Range of Product	Telemecanique Inductive proximity sensors XS
Series name	General purpose
Sensor Type	Inductive proximity sensor
Sensor name	XS4
Sensor design	Cylindrical M8
Size	50 mm
Body type	Fixed
Detector flush mounting acceptance	Non flush mountable
Material	Plastic
Type of output signal	Discrete
Wiring Technique	3-wire
[Sn] nominal sensing distance	0.10 in (2.5 mm)
Discrete output function	1 NO
Output circuit type	DC
Discrete output type	PNP
Electrical connection	Cable
Cable length	16.40 ft (5 m)
[Us] rated supply voltage	12...48 V DC reverse polarity protection
Switching capacity in mA	<= 200 mA DC overload and short-circuit protection
IP degree of protection	IP67 conforming to IEC 60529

## Complementary

Thread type	M8 x 1
Detection face	Frontal
Front material	PPS
Enclosure Material	PPS
Operating zone	0.00...0.08 in (0...2 mm)
Differential travel	1...15% of Sr
Cable composition	3 x 0.11 mm <sup>2</sup>
Wire insulation material	PvR
Status LED	Output state 1 LED yellow)
Supply voltage limits	10...58 V DC
Switching frequency	<= 5000 Hz
Maximum voltage drop	<2 V closed)
Current consumption	0...10 mA no-load
Maximum delay first up	10 ms
Maximum delay response	0.1 ms
Maximum delay recovery	0.1 ms
Marking	CE
Threaded length	1.57 in (40 mm)
Height	0.31 in (8 mm)

Length	1.97 in (50 mm)
Net Weight	0.33 lb(US) (0.15 kg)

## Environment

Product Certifications	CSA UL CCC
Ambient Air Temperature for Operation	-13...158 °F (-25...70 °C)
Ambient Air Temperature for Storage	-40...185 °F (-40...85 °C)
Vibration resistance	25 gn +/- 2 mm 10...55 Hz)IEC 60068-2-6
Shock resistance	50 gn 11 ms IEC 60068-2-27

## Ordering and shipping details

Category	22486-SENSORS, PROXIMITY
Discount Schedule	DS2
GTIN	3389110734362
Nbr. of units in pkg.	1
Package weight(Lbs)	0.12 lb(US) (0.05 kg)
Returnability	No
Country of origin	FR

## Packing Units

Package 1 Height	0.041 dm
Package 1 width	0.130 dm
Package 1 Length	0.094 dm

## Offer Sustainability

Sustainable offer status	Green Premium product
California proposition 65	WARNING: This product can expose you to chemicals including: Diisononyl phthalate (DINP), which is known to the State of California to cause cancer, and Di-isodecyl phthalate (DIDP), which is known to the State of California to cause birth defects or other reproductive harm. For more information go to <a href="http://www.P65Warnings.ca.gov">www.P65Warnings.ca.gov</a>
REACH Regulation	<a href="#">REACH Declaration</a>
EU RoHS Directive	Pro-active compliance (Product out of EU RoHS legal scope) <a href="#">EU RoHS Declaration</a>
Mercury free	Yes
RoHS exemption information	<a href="#">Yes</a>
Environmental Disclosure	<a href="#">Product Environmental Profile</a>
Circularity Profile	<a href="#">End Of Life Information</a>

## Contractual warranty

Warranty	18 months
----------	-----------

Dimensions

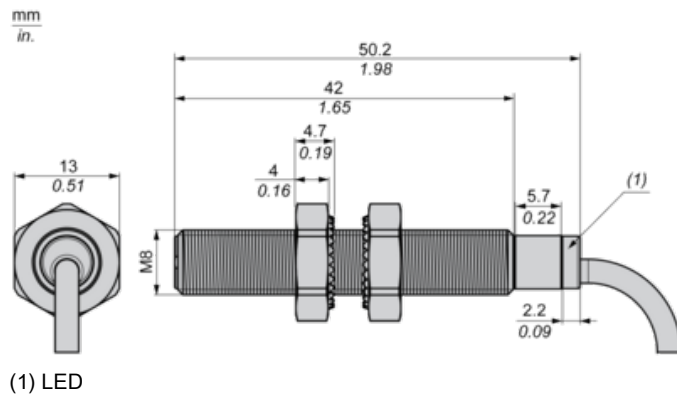

### Minimum Mounting Distances

Side by side

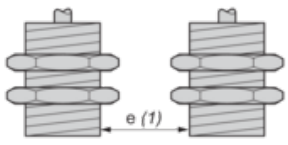

$e (1) \geq 10 \text{ mm}/0.39 \text{ in.}$

Face to face

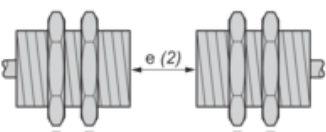

$e (2) \geq 30 \text{ mm}/1.18 \text{ in.}$

Facing a metal object

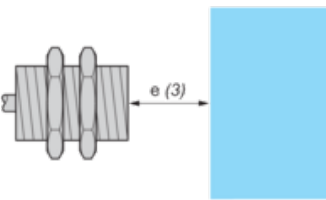

$e (3) \geq 7.5 \text{ mm}/0.30 \text{ in.}$

Mounted in a metal support

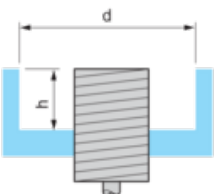

$d \geq 24 \text{ mm}/0.94 \text{ in.}$

$h \geq 5 \text{ mm}/0.20 \text{ in.}$

### Mounting

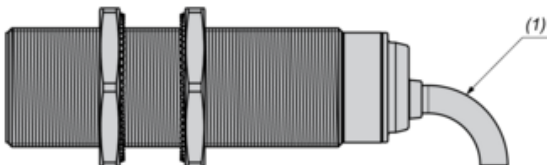

(1) Bending cable: 4 x external cable diameter

---

Wiring Schemes

---

PNP

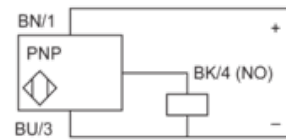

BU : Blue  
BN : Brown  
BK : Black