

DIGI POT 2 click schematic v100

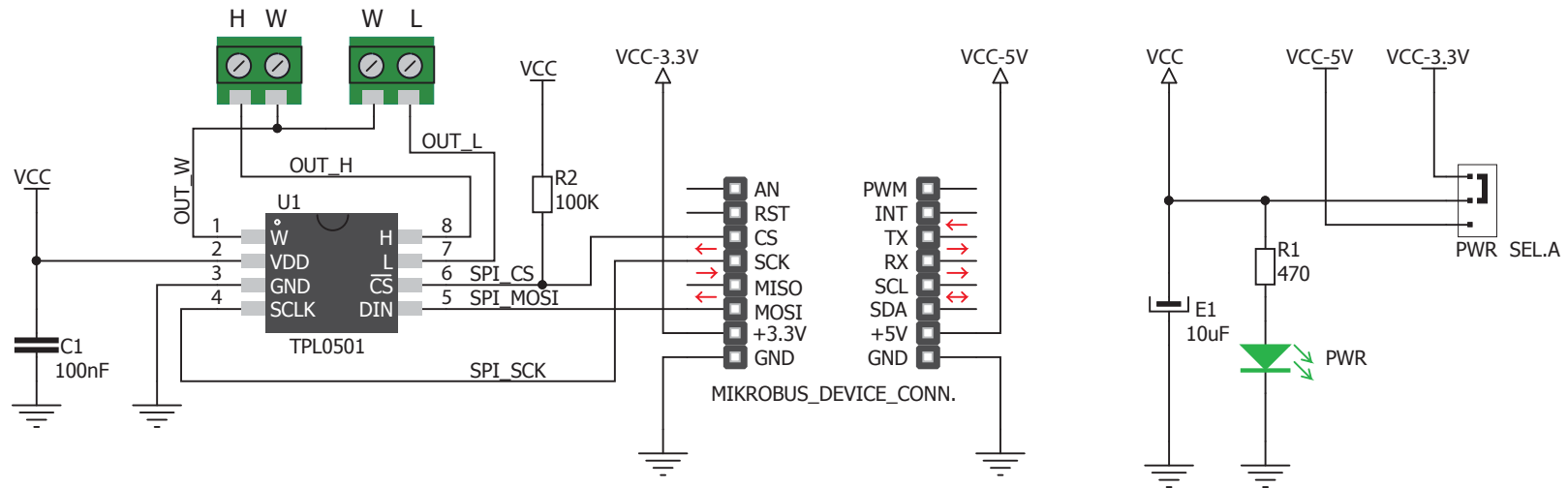

www.mikroe.com