

24 GHz to 38 GHz, GaAs, MMIC, Double Balanced Mixer

FEATURES

- ▶ Downconverter
 - ▶ Conversion loss
 - ▶ 9 dB typical for 24 GHz to 29 GHz
 - ▶ 11 dB typical for 29 GHz to 38 GHz
 - ▶ LO to RF isolation
 - ▶ 40 dB typical for 24 GHz to 29 GHz
 - ▶ 38 dB typical for 29 GHz to 38 GHz
 - ▶ LO to IF isolation
 - ▶ 27 dB typical for 24 GHz to 29 GHz
 - ▶ 44 dB typical for 29 GHz to 38 GHz
 - ▶ RF to IF isolation
 - ▶ 20 dB typical for 24 GHz to 29 GHz
 - ▶ 28 dB typical for 29 GHz to 38 GHz
 - ▶ Input IP3
 - ▶ 18 dBm typical for 24 GHz to 29 GHz
 - ▶ 19 dBm typical for 29 GHz to 38 GHz (downconverter)
- ▶ IF frequency: dc to 18 GHz
- ▶ Passive, no dc bias required

APPLICATIONS

- ▶ Point to point radios
- ▶ Point to multipoint radios and very small aperture terminal (VSAT) radios
- ▶ Test equipment and sensors
- ▶ Military end use

FUNCTIONAL BLOCK DIAGRAM

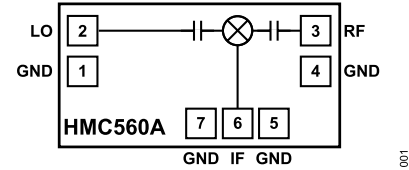

Figure 1.

GENERAL DESCRIPTION

The HMC560A chip is a gallium arsenide (GaAs), monolithic microwave integrated circuit (MMIC), double balanced mixer that can be used as an upconverter or downconverter from 24 GHz to 38 GHz in a small chip area. This mixer requires no external component or matching circuitry.

The HMC560A provides high local oscillator (LO) to RF and LO to intermediate frequency (IF) suppression, 40 dB and 44 dB, respectively, due to optimized balun structures. The mixer operates with LO amplitudes from 9 dBm to 15 dBm.

TABLE OF CONTENTS

Features.....	1	Upconverter Performance, IF = 1 GHz.....	15
Applications.....	1	Upconverter Performance, IF = 10 GHz.....	17
Functional Block Diagram.....	1	Upconverter Performance, IF = 18 GHz.....	19
General Description.....	1	Isolation and Return Loss.....	21
Specifications.....	3	IF Bandwidth—Downconverter.....	23
Electrical Specifications.....	3	Spurious Performance.....	25
Absolute Maximum Ratings.....	4	Theory of Operation.....	26
Electrostatic Discharge (ESD) Ratings.....	4	Applications Information.....	27
ESD Caution.....	4	Typical Application Circuit.....	27
Pin Configuration and Function Descriptions.....	5	Mounting and Bonding Techniques.....	27
Interface Schematics.....	5	Handling Precautions.....	27
Typical Performance Characteristics.....	6	Mounting.....	28
Downconverter Performance, IF = 1 GHz.....	6	Wire Bonding.....	28
Downconverter Performance, IF = 10 GHz.....	9	Outline Dimensions.....	29
Downconverter Performance, IF = 18 GHz.....	12	Ordering Guide.....	29

REVISION HISTORY**4/2023—Rev. 0 to Rev. A**

Updated Outline Dimensions.....	29
---------------------------------	----

9/2020—Revision 0: Initial Version

SPECIFICATIONS

ELECTRICAL SPECIFICATIONS

$T_A = 25^\circ\text{C}$, $IF = 1\text{ GHz}$, LO drive level = 13 dBm, and all measurements performed as a downconverter with the upper sideband selected, unless otherwise noted.

Table 1.

Parameter	Test Conditions/Comments	Min	Typ	Max	Unit
FREQUENCY					
RF Pad		24		38	GHz
IF Pad		DC		18	GHz
LO Pad		22		38	GHz
LO AMPLITUDE					
		9	13	15	dBm
24 GHz TO 29 GHz PERFORMANCE					
Downconverter					
Conversion Loss			9	12	dB
Single-Sideband Noise Figure	Measurements taken with external LO amplifier		12		dB
Input Third-Order Intercept (IP3)	1 MHz separation between inputs	13	18		dBm
Input 1 dB Compression Point (P1dB)			10		dBm
Input Second-Order Intercept (IP2)	1 MHz separation between inputs		42		dBm
Upconverter					
Conversion Loss			9		dB
Input IP3	1 MHz separation between inputs		18		dBm
Input P1dB			8		dBm
Isolation					
RF to IF		13	20		dB
LO to RF			40		dB
LO to IF		20	27		dB
29 GHz TO 38 GHz PERFORMANCE					
Downconverter					
Conversion Loss			11	14	dB
Single-Sideband Noise Figure	Measurements taken with external LO amplifier		14		dB
Input IP3	1 MHz separation between inputs	14	19		dBm
Input P1dB			12		dBm
Input IP2	1 MHz separation between inputs		38		dBm
Upconverter					
Conversion Loss			10		dB
Input IP3	1 MHz separation between inputs		18		dBm
Input P1dB			9		dBm
Isolation					
RF to IF		24	28		dB
LO to RF			38		dB
LO to IF		34	44		dB

ABSOLUTE MAXIMUM RATINGS

Table 2.

Parameter	Rating
Input Power	
RF	25 dBm
LO	23 dBm
IF	25 dBm
IF Source and Sink Current	2 mA
Continuous Power Dissipation, P_{DISS} ($T_A = 85^\circ\text{C}$, Derate 5.3 mW/ $^\circ\text{C}$ Above 85°C)	344 mW
Temperature	
Channel	150°C/W
Storage Range	-65°C to +150°C
Operating Range	-40°C to +85°C

Stresses at or above listed under Absolute Maximum Ratings may cause permanent damage to the product. This is a stress rating only; functional operation of the product at these or any other conditions above those indicated in the operational section of this specification is not implied. Operation beyond the maximum operating conditions for extended periods may affect product reliability.

ELECTROSTATIC DISCHARGE (ESD) RATINGS

The following ESD information is provided for handling of ESD-sensitive devices in an ESD protected area only.

Human body model (HBM) per ANSI/ESDA/JEDEC JS-001.

Field induced charged device model (FICDM) per JESD22-C101F.

ESD Ratings for HMC560A

Table 3. HMC560A, 7-Pad Bare Die (CHIP)

ESD Model	Withstand Threshold (V)	Class
HBM	500	1B
FICDM	1250	C3

ESD CAUTION



ESD (electrostatic discharge) sensitive device. Charged devices and circuit boards can discharge without detection. Although this product features patented or proprietary protection circuitry, damage may occur on devices subjected to high energy ESD. Therefore, proper ESD precautions should be taken to avoid performance degradation or loss of functionality.

PIN CONFIGURATION AND FUNCTION DESCRIPTIONS

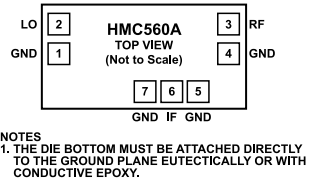

Figure 2. Pad Configuration

Table 4. Pad Function Descriptions

Pad No.	Mnemonic	Description
1, 4, 5, 7	GND	Not Internally Connected. No connection is required. The GND pads can be connected to RF and dc ground without affecting performance. See Figure 3 for the GND interface schematic.
2	LO	Local Oscillator Port. LO is ac-coupled and matched to 50 Ω. See Figure 4 for the LO interface schematic.
3	RF	Radio Frequency Port. RF is ac-coupled and matched to 50 Ω. See Figure 5 for the RF interface schematic.
6	IF	Intermediate Frequency Port. IF is dc-coupled. For applications not requiring operation to dc, dc block the IF port externally using a series capacitor of a value chosen to pass the necessary IF frequency range. For operation to dc, the IF pad must not source or sink more than 2 mA of current or die malfunction and possible die failure may result. See Figure 6 for the IF interface schematic.
Die Bottom		The die bottom must be attached directly to the ground plane eutectically or with conductive epoxy.

INTERFACE SCHEMATICS



Figure 3. GND Interface Schematic

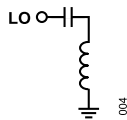

Figure 4. LO Interface Schematic

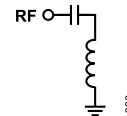

Figure 5. RF Interface Schematic



Figure 6. IF Interface Schematic

TYPICAL PERFORMANCE CHARACTERISTICS

DOWNCONVERTER PERFORMANCE, IF = 1 GHz

Upper Sideband (Low-Side LO)

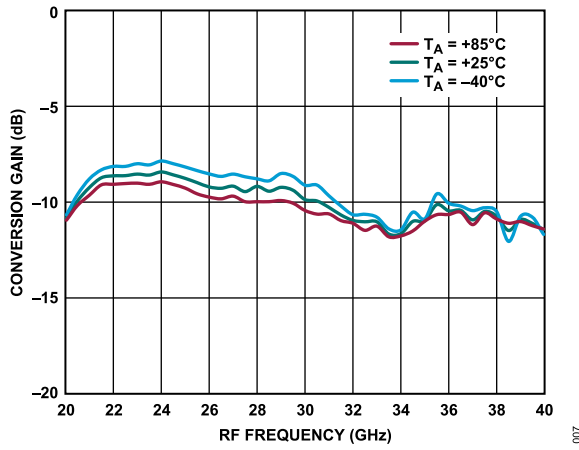

Figure 7. Conversion Gain vs. RF Frequency at Various Temperatures, LO = 13 dBm

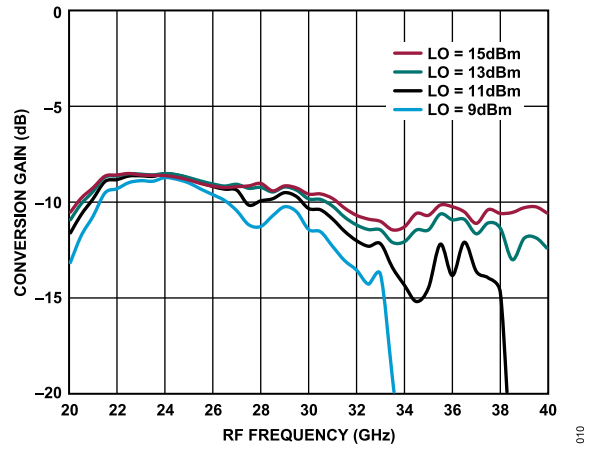

Figure 10. Conversion Gain vs. RF Frequency at Various LO Power Levels, $T_A = 25^\circ\text{C}$

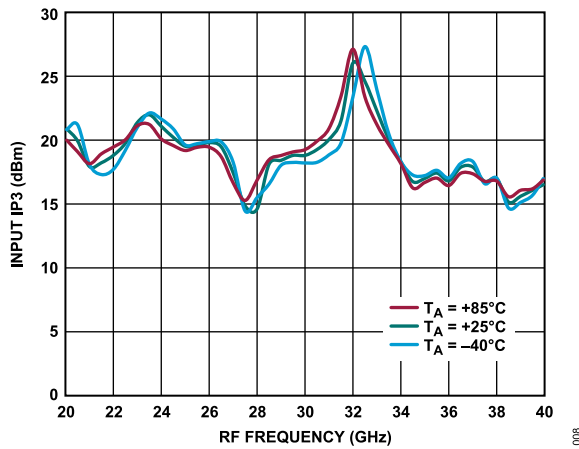

Figure 8. Input IP3 vs. RF Frequency at Various Temperatures, LO = 13 dBm

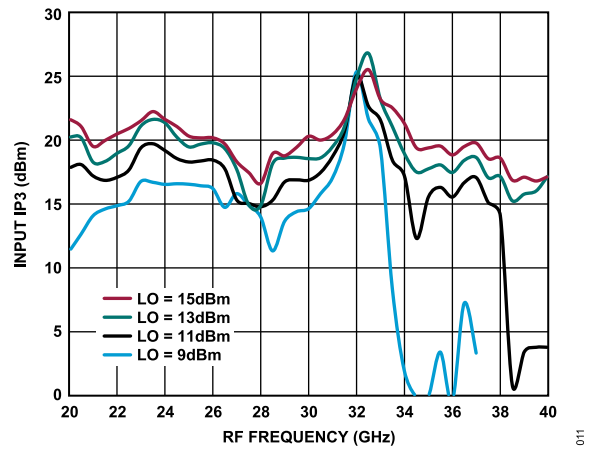

Figure 11. Input IP3 vs. RF Frequency at Various LO Power Levels, $T_A = 25^\circ\text{C}$

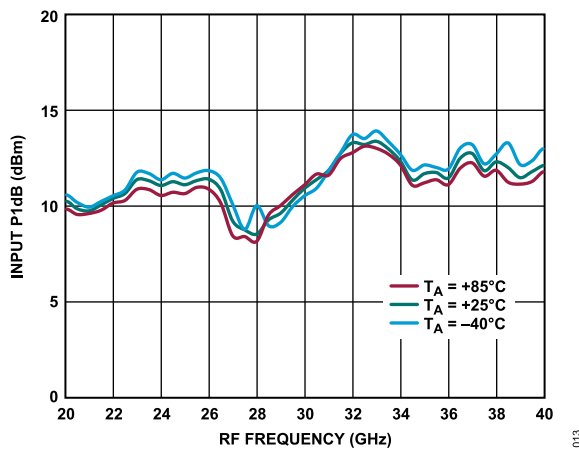

Figure 9. Input P1dB vs. RF Frequency at Various Temperatures, LO = 13 dBm

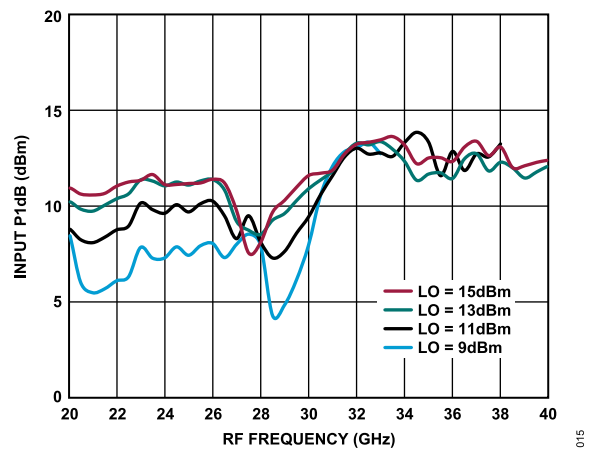

Figure 12. Input P1dB vs. RF Frequency at Various LO Power Levels, $T_A = 25^\circ\text{C}$

TYPICAL PERFORMANCE CHARACTERISTICS

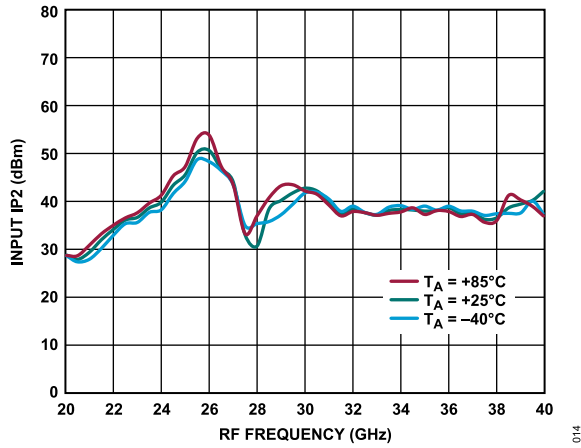

Figure 13. Input IP2 vs. RF Frequency at Various Temperatures, LO = 13 dBm

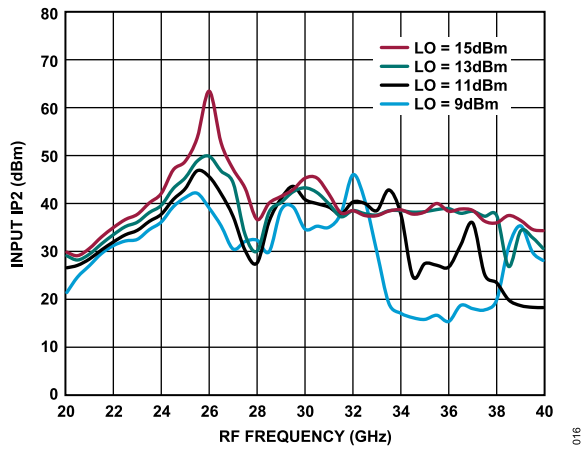

Figure 14. Input IP2 vs. RF Frequency at Various LO Power Levels, T_A = 25°C

TYPICAL PERFORMANCE CHARACTERISTICS

Lower Sideband (High-Side LO)

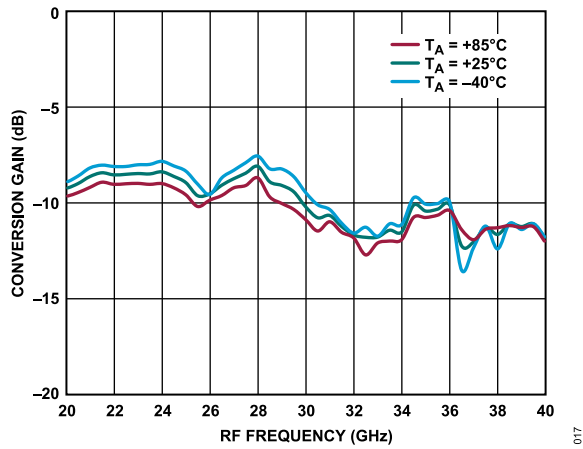

Figure 15. Conversion Gain vs. RF Frequency at Various Temperatures, LO = 13 dBm

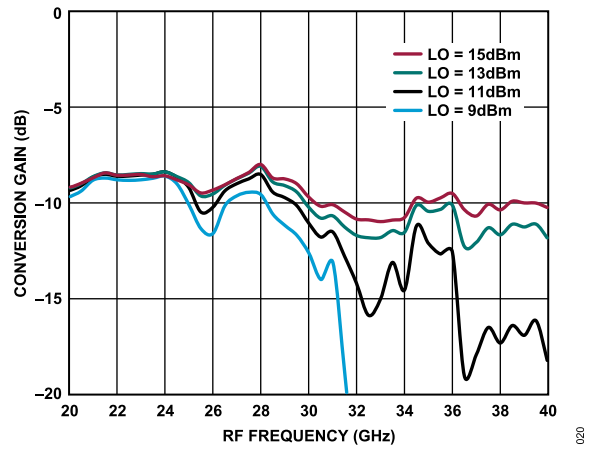

Figure 18. Conversion Gain vs. RF Frequency at Various LO Power Levels, $T_A = 25^\circ\text{C}$

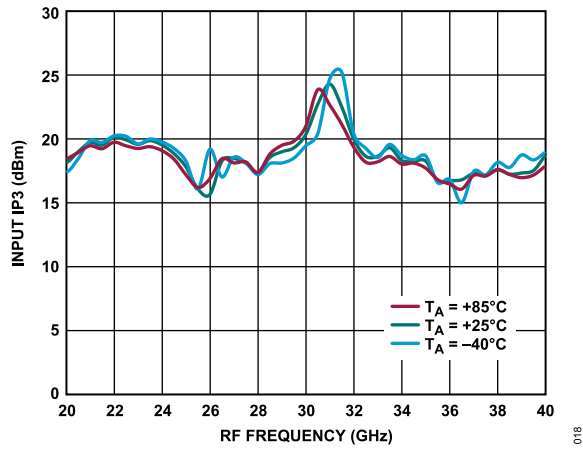

Figure 16. Input IP3 vs. RF Frequency at Various Temperatures, LO = 13 dBm

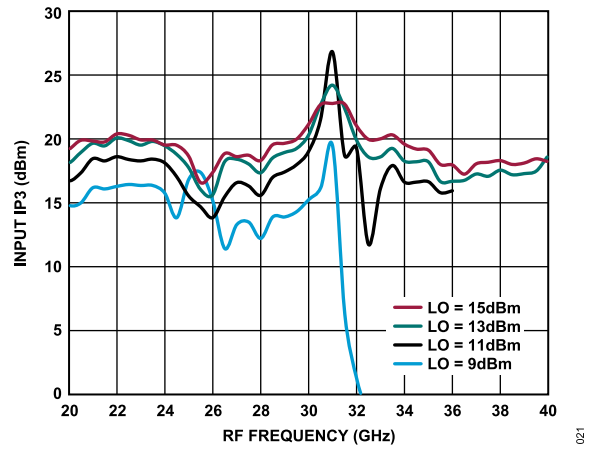

Figure 19. Input IP3 vs. RF Frequency at Various LO Power Levels, $T_A = 25^\circ\text{C}$

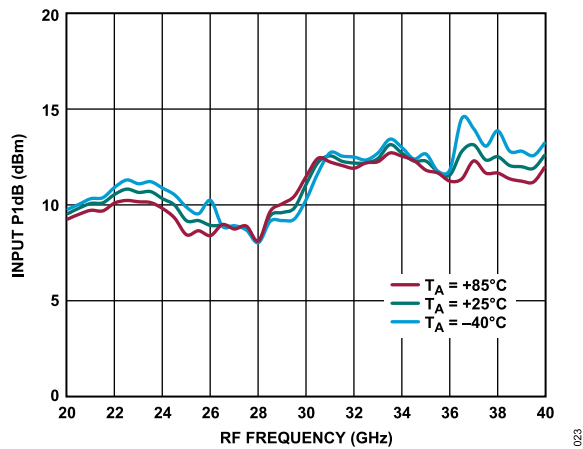

Figure 17. Input P1dB vs. RF Frequency at Various Temperatures, LO = 13 dBm

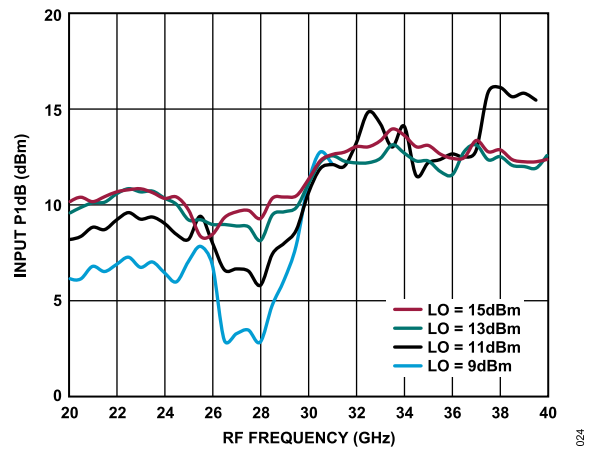

Figure 20. Input P1dB vs. RF Frequency at Various LO Power Levels, $T_A = 25^\circ\text{C}$

TYPICAL PERFORMANCE CHARACTERISTICS

DOWNCONVERTER PERFORMANCE, IF = 10 GHz

Upper Sideband (Low-Side LO)

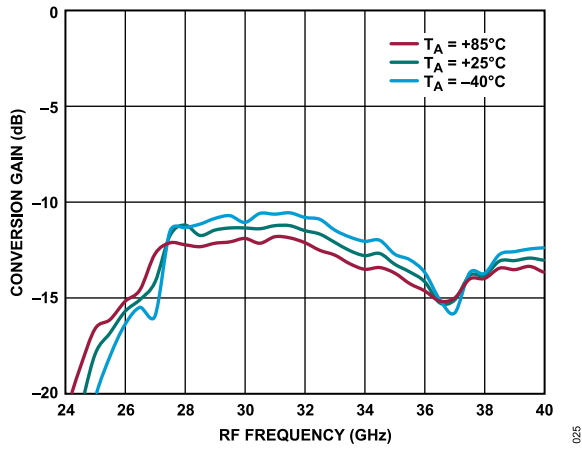

Figure 21. Conversion Gain vs. RF Frequency at Various Temperatures, LO = 13 dBm

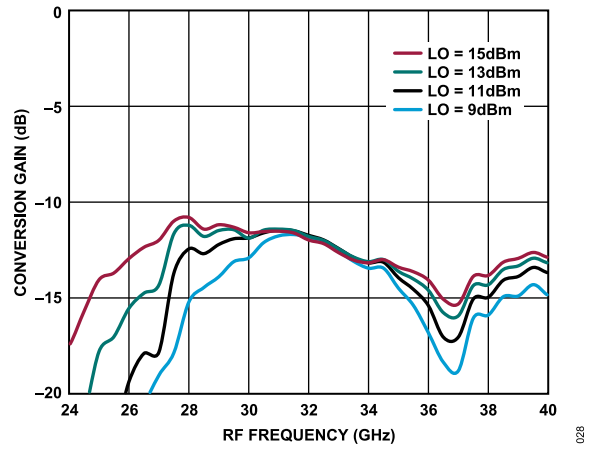

Figure 24. Conversion Gain vs. RF Frequency at Various LO Power Levels, $T_A = 25^\circ\text{C}$

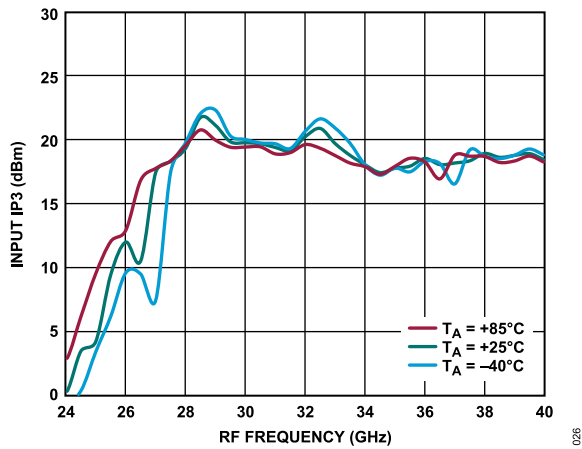

Figure 22. Input IP3 vs. RF Frequency at Various Temperatures, LO = 13 dBm

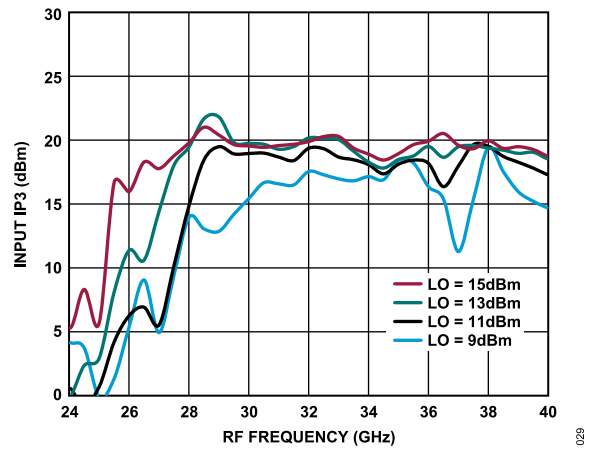

Figure 25. Input IP3 vs. RF Frequency at Various LO Power Levels, $T_A = 25^\circ\text{C}$

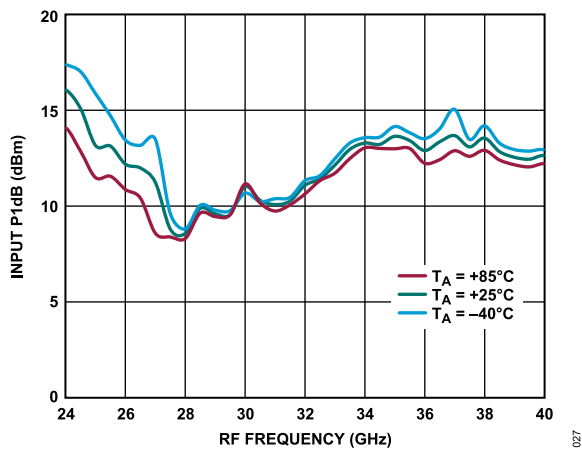

Figure 23. Input P1dB vs. RF Frequency at Various Temperatures, LO = 13 dBm

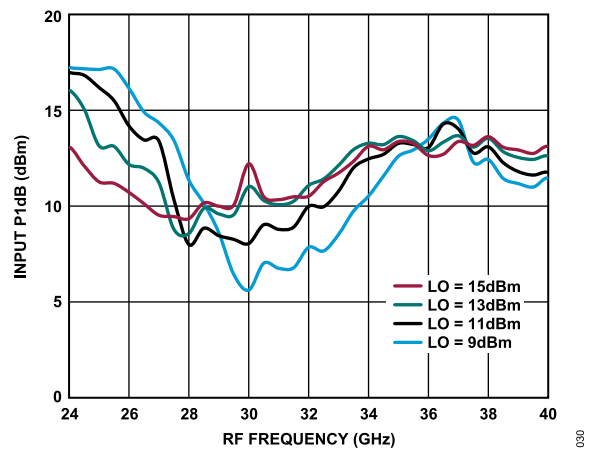

Figure 26. Input P1dB vs. RF Frequency at Various LO Power Levels, $T_A = 25^\circ\text{C}$

TYPICAL PERFORMANCE CHARACTERISTICS

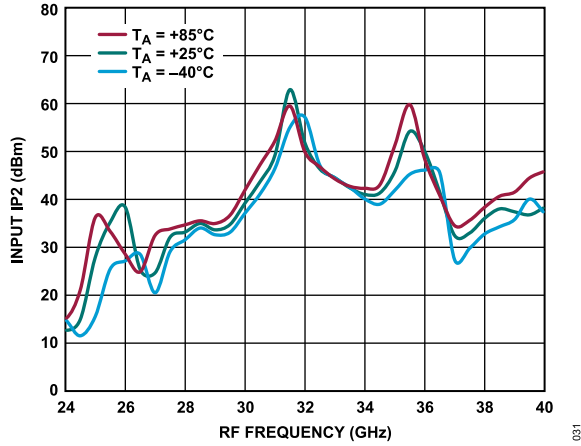

Figure 27. Input IP2 vs. RF Frequency at Various Temperatures, LO = 13 dBm

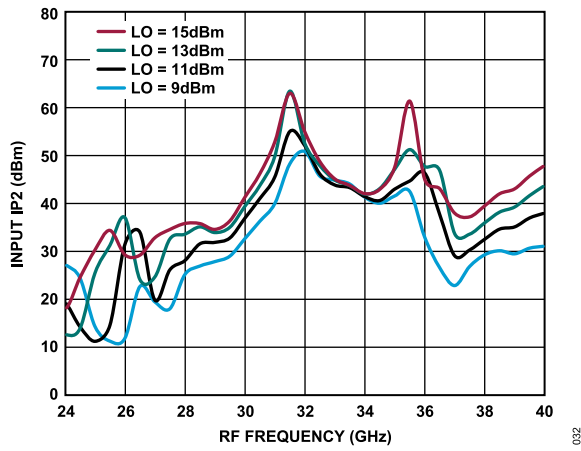

Figure 28. Input IP2 vs. RF Frequency at Various LO Power Levels, $T_A = 25^\circ\text{C}$

TYPICAL PERFORMANCE CHARACTERISTICS

Lower Sideband (High-Side LO)

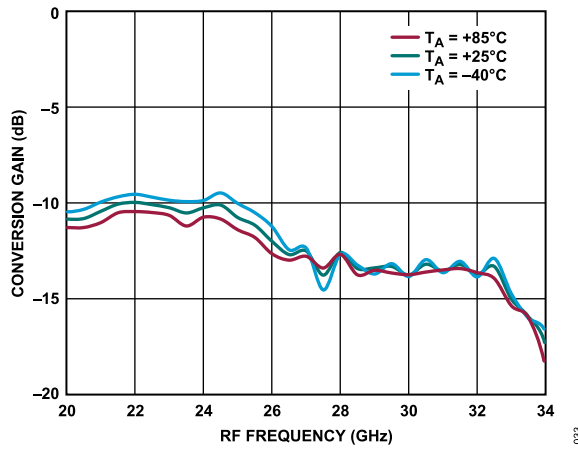

Figure 29. Conversion Gain vs. RF Frequency at Various Temperatures, LO = 13 dBm

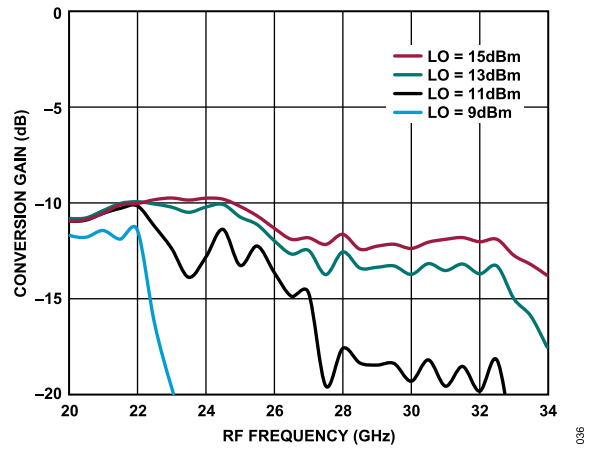

Figure 32. Conversion Gain vs. RF Frequency at Various LO Power Levels, $T_A = 25^\circ\text{C}$

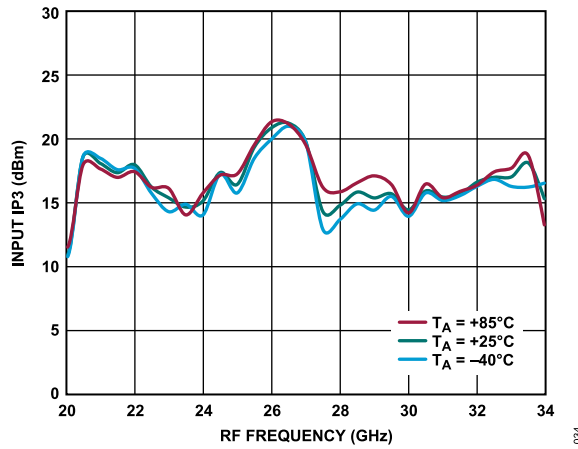

Figure 30. Input IP3 vs. RF Frequency at Various Temperatures, LO = 13 dBm

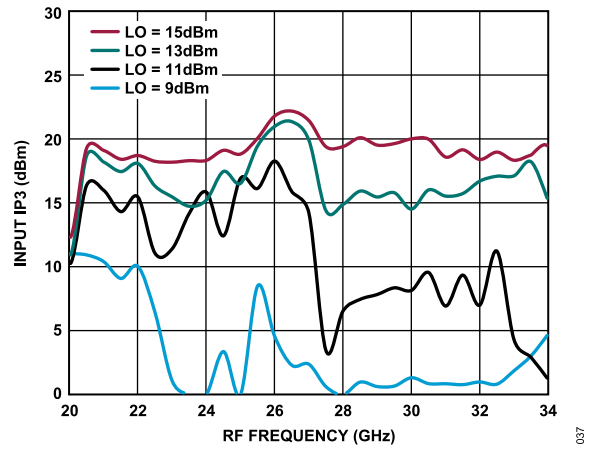

Figure 33. Input IP3 vs. RF Frequency at Various LO Power Levels, $T_A = 25^\circ\text{C}$

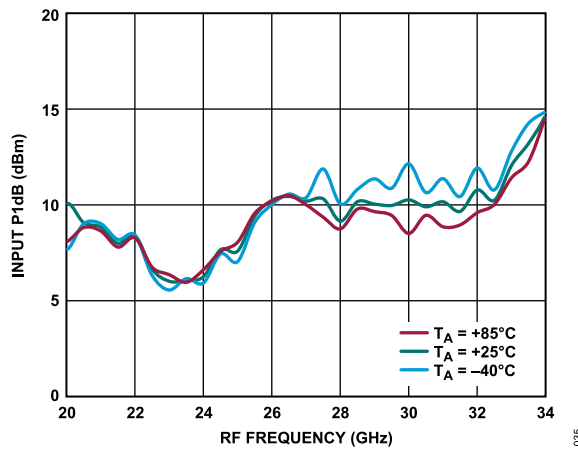

Figure 31. Input P1dB vs. RF Frequency at Various Temperatures, LO = 13 dBm

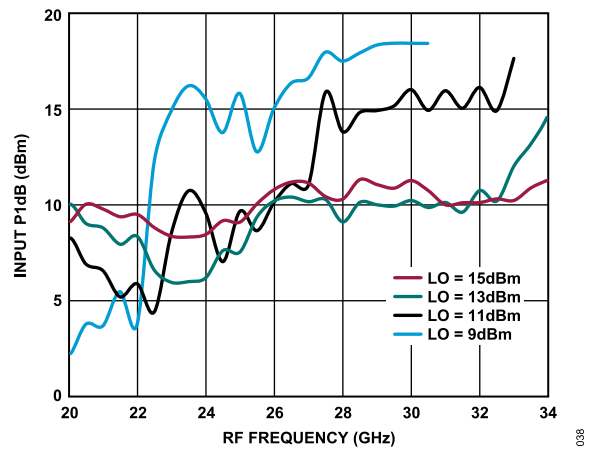

Figure 34. Input P1dB vs. RF Frequency at Various LO Power Levels, $T_A = 25^\circ\text{C}$

TYPICAL PERFORMANCE CHARACTERISTICS

DOWNCONVERTER PERFORMANCE, IF = 18 GHz

Upper Sideband (Low-Side LO)

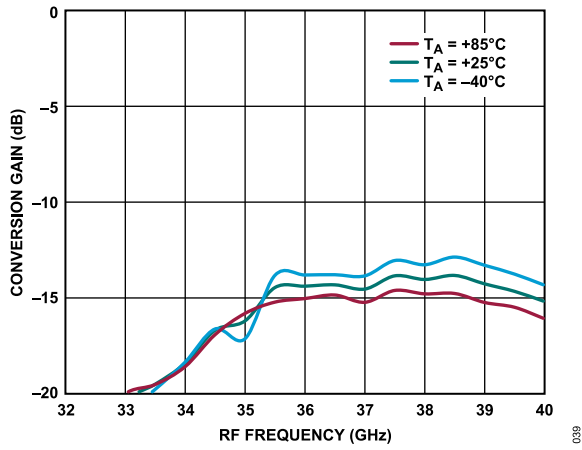

Figure 35. Conversion Gain vs. RF Frequency at Various Temperatures, LO = 13 dBm

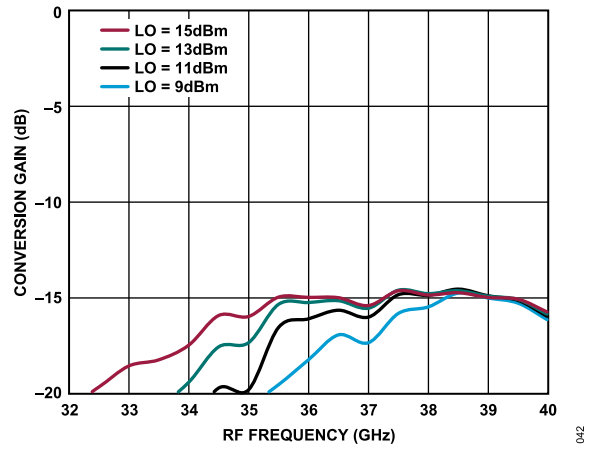

Figure 38. Conversion Gain vs. RF Frequency at Various LO Power Levels, $T_A = 25^\circ\text{C}$

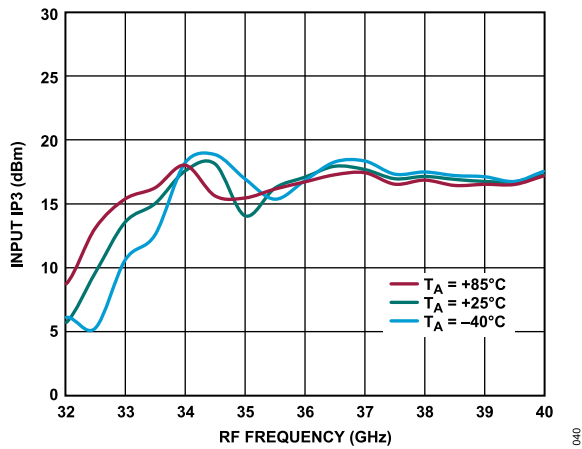

Figure 36. Input IP3 vs. RF Frequency at Various Temperatures, LO = 13 dBm

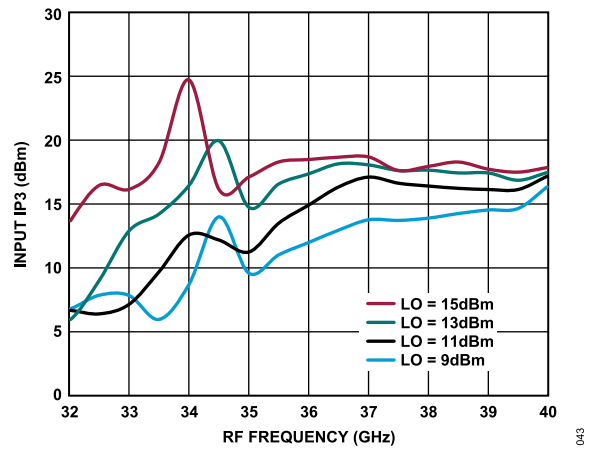

Figure 39. Input IP3 vs. RF Frequency at Various LO Power Levels, $T_A = 25^\circ\text{C}$

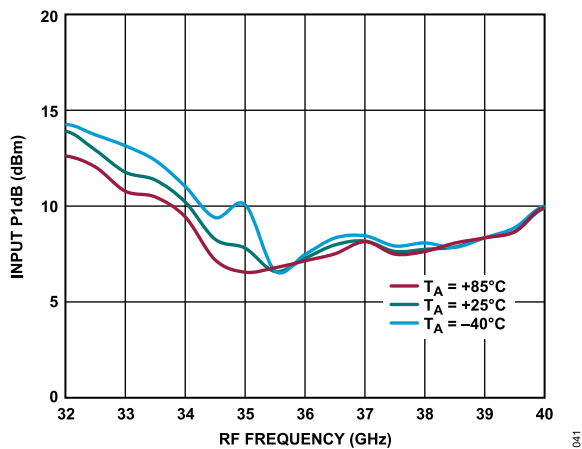

Figure 37. Input P1dB vs. RF Frequency at Various Temperatures, LO = 13 dBm

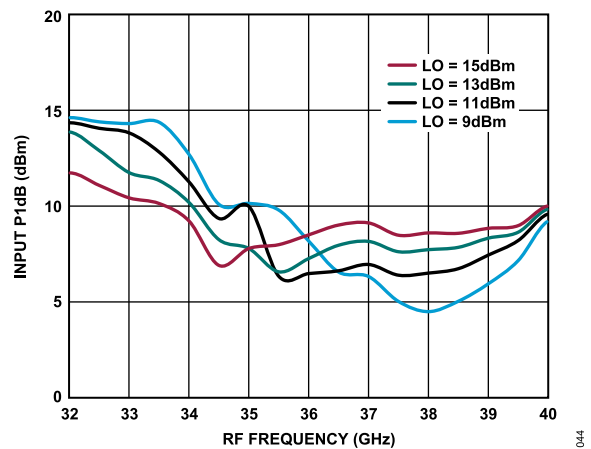

Figure 40. Input P1dB vs. RF Frequency at Various LO Power Levels, $T_A = 25^\circ\text{C}$

TYPICAL PERFORMANCE CHARACTERISTICS

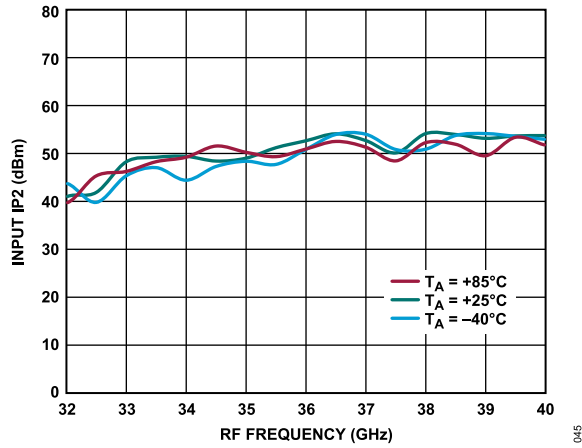

Figure 41. Input IP2 vs. RF Frequency at Various Temperatures, LO = 13 dBm

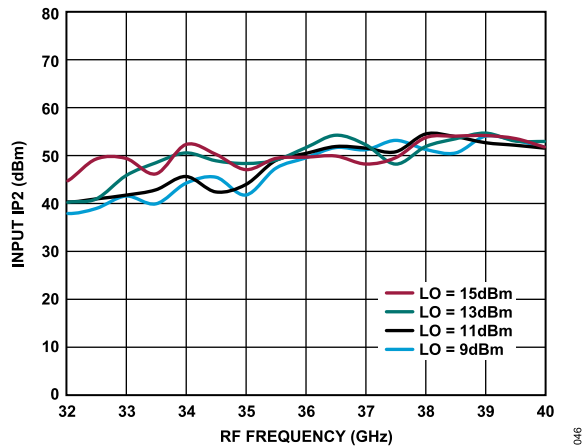

Figure 42. Input IP2 vs. RF Frequency at Various LO Power Levels, T_A = 25°C

TYPICAL PERFORMANCE CHARACTERISTICS

Lower Sideband (High-Side LO)

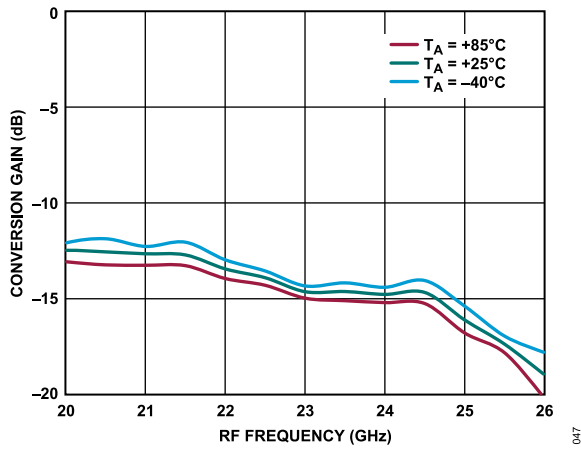

Figure 43. Conversion Gain vs. RF Frequency at Various Temperatures, LO = 13 dBm

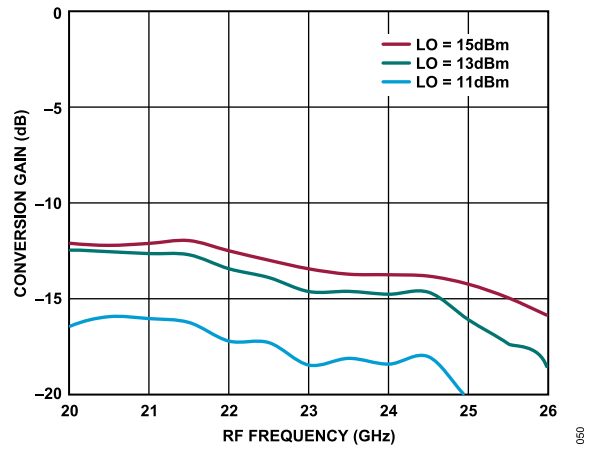

Figure 46. Conversion Gain vs. RF Frequency at Various LO Power Levels, $T_A = 25^\circ\text{C}$

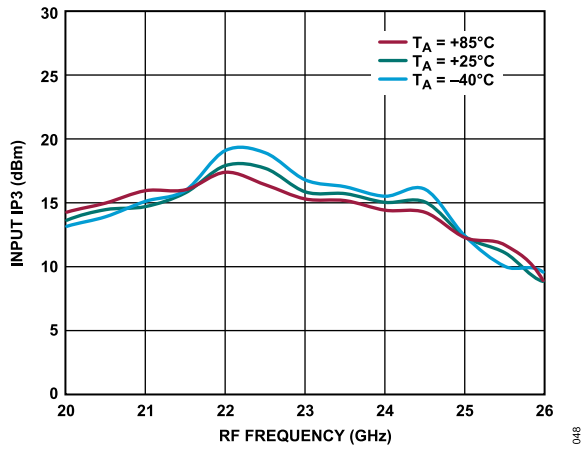

Figure 44. Input IP3 vs. RF Frequency at Various Temperatures, LO = 13 dBm

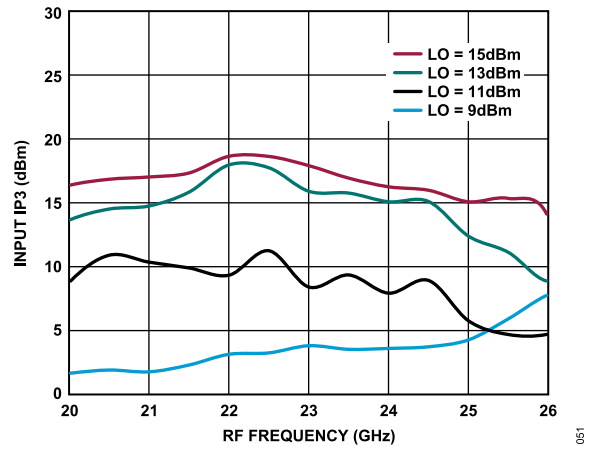

Figure 47. Input IP3 vs. RF Frequency at Various LO Power Levels, $T_A = 25^\circ\text{C}$

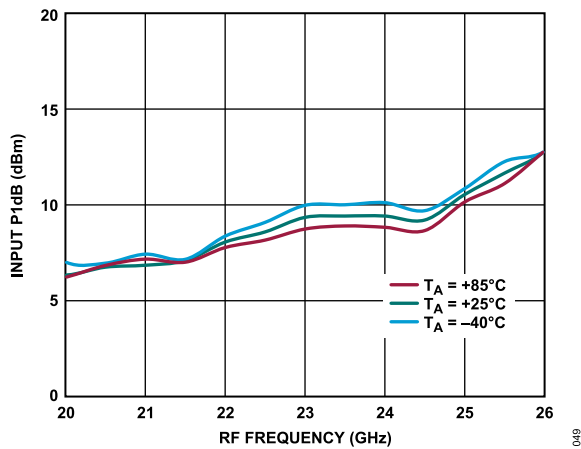

Figure 45. Input P1dB vs. RF Frequency at Various Temperatures, LO = 13 dBm

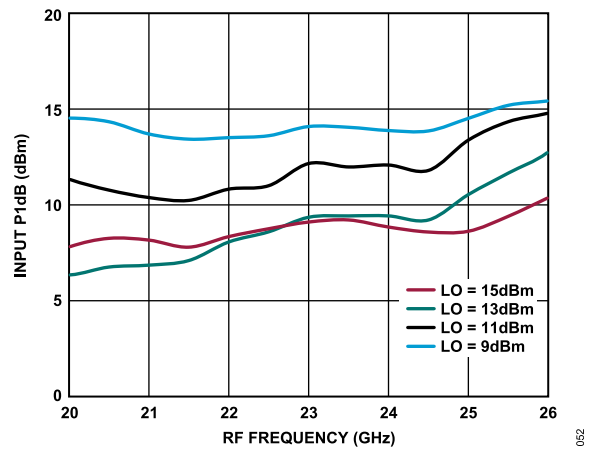

Figure 48. Input P1dB vs. RF Frequency at Various LO Power Levels, $T_A = 25^\circ\text{C}$

TYPICAL PERFORMANCE CHARACTERISTICS

UPCONVERTER PERFORMANCE, IF = 1 GHz

Upper Sideband (Low-Side LO)

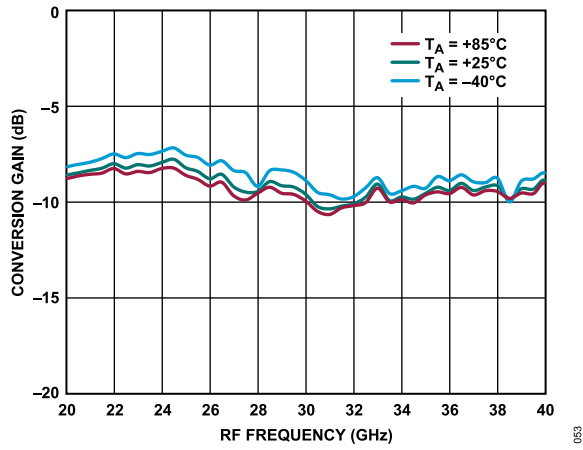

Figure 49. Conversion Gain vs. RF Frequency at Various Temperatures, LO = 13 dBm

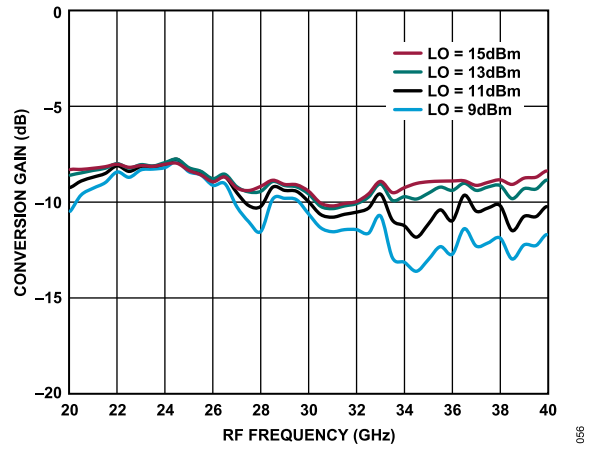

Figure 52. Conversion Gain vs. RF Frequency at Various LO Power Levels, $T_A = 25^\circ\text{C}$

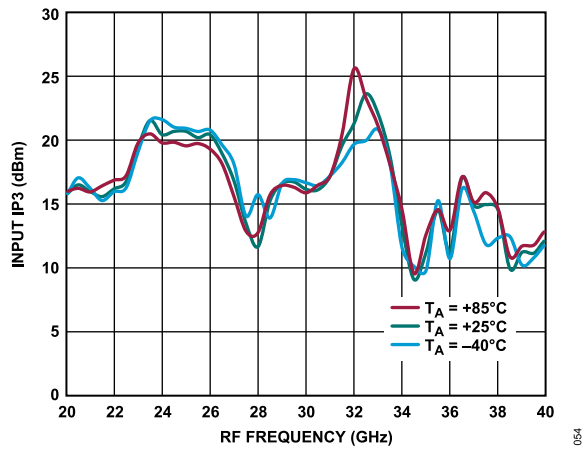

Figure 50. Input IP3 vs. RF Frequency at Various Temperatures, LO = 13 dBm

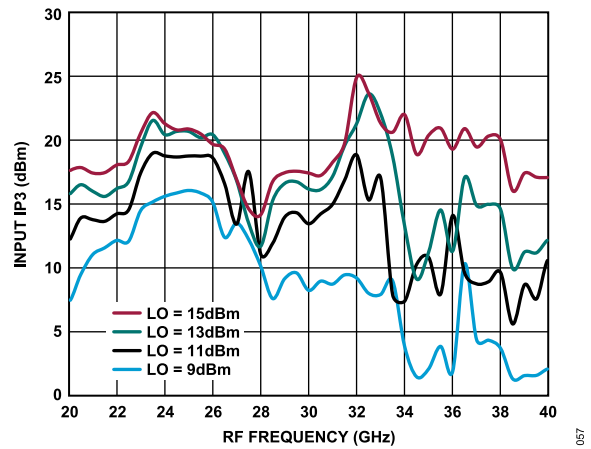

Figure 53. Input IP3 vs. RF Frequency at Various LO Power Levels, $T_A = 25^\circ\text{C}$

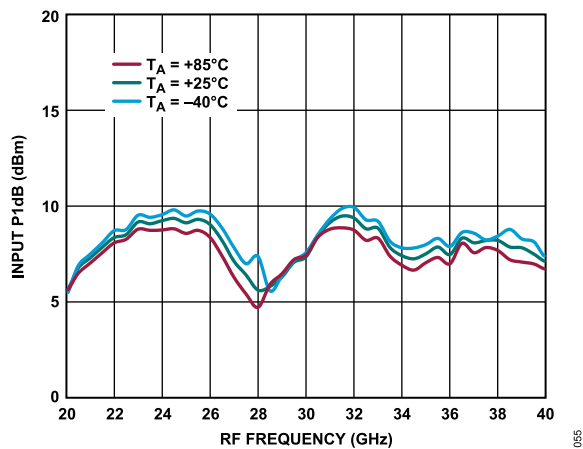

Figure 51. Input P1dB vs. RF Frequency at Various Temperatures, LO = 13 dBm

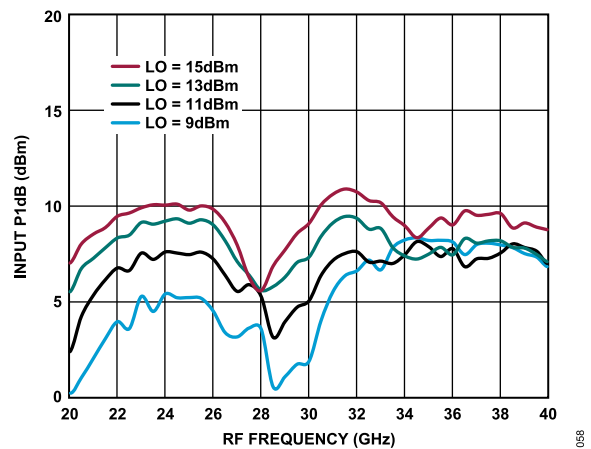

Figure 54. Input P1dB vs. RF Frequency at Various LO Power Levels, $T_A = 25^\circ\text{C}$

TYPICAL PERFORMANCE CHARACTERISTICS

Lower Sideband (High-Side LO)

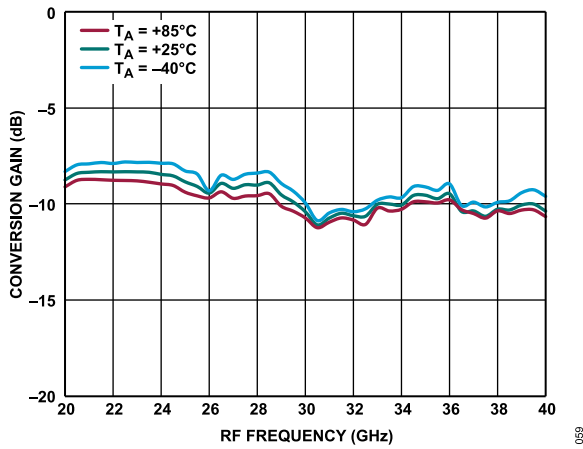

Figure 55. Conversion Gain vs. RF Frequency at Various Temperatures, LO = 13 dBm

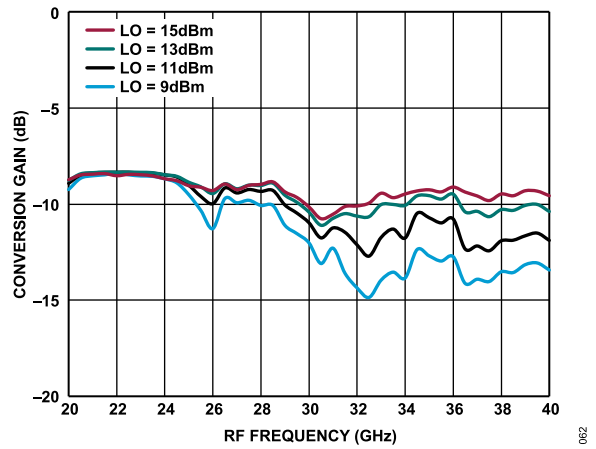

Figure 58. Conversion Gain vs. RF Frequency at Various LO Power Levels, $T_A = 25^\circ\text{C}$

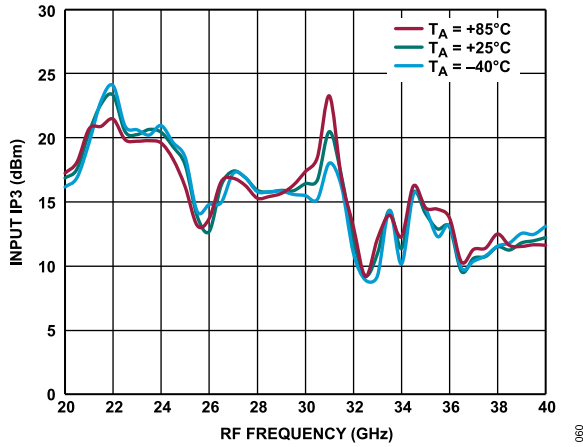

Figure 56. Input IP3 vs. RF Frequency at Various Temperatures, LO = 13 dBm

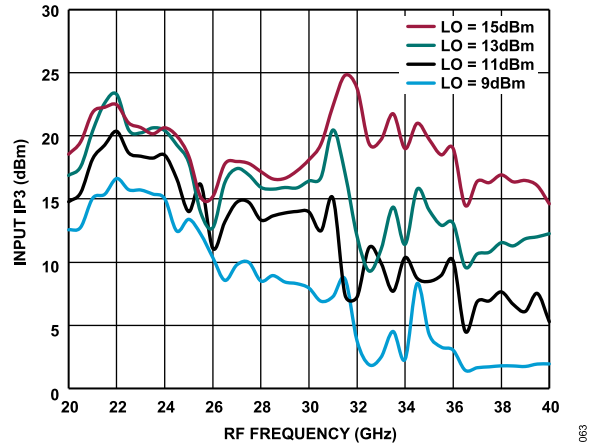

Figure 59. Input IP3 vs. RF Frequency at Various LO Power Levels, $T_A = 25^\circ\text{C}$

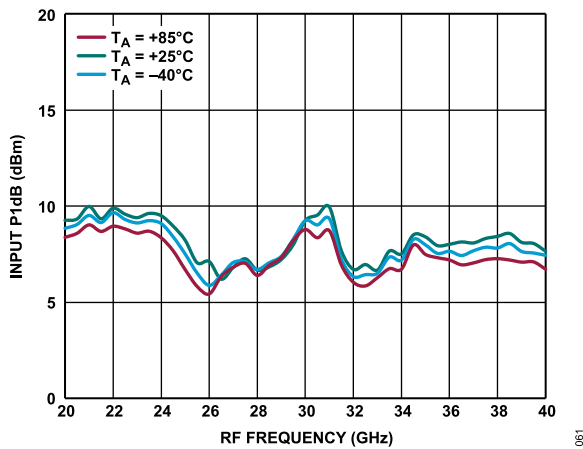

Figure 57. Input P1dB vs. RF Frequency at Various Temperatures, LO = 13 dBm

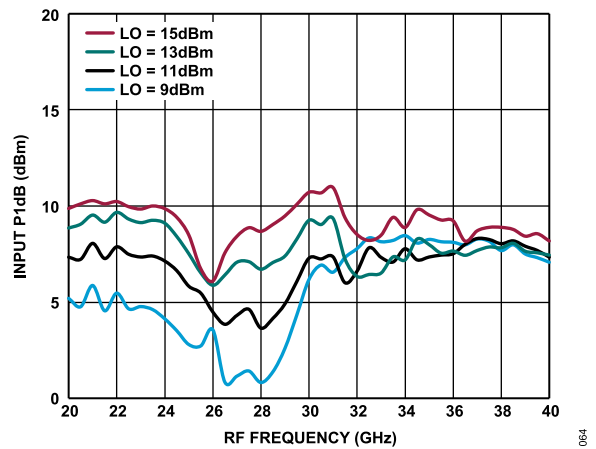

Figure 60. Input P1dB vs. RF Frequency at Various LO Power Levels, $T_A = 25^\circ\text{C}$

TYPICAL PERFORMANCE CHARACTERISTICS

UPCONVERTER PERFORMANCE, IF = 10 GHZ

Upper Sideband (Low-Side LO)

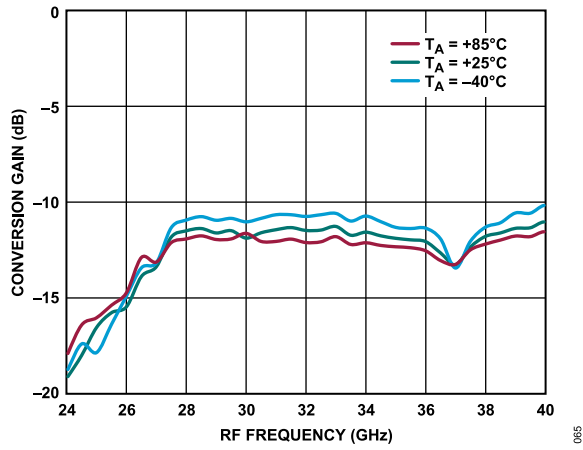

Figure 61. Conversion Gain vs. RF Frequency at Various Temperatures, LO = 13 dBm

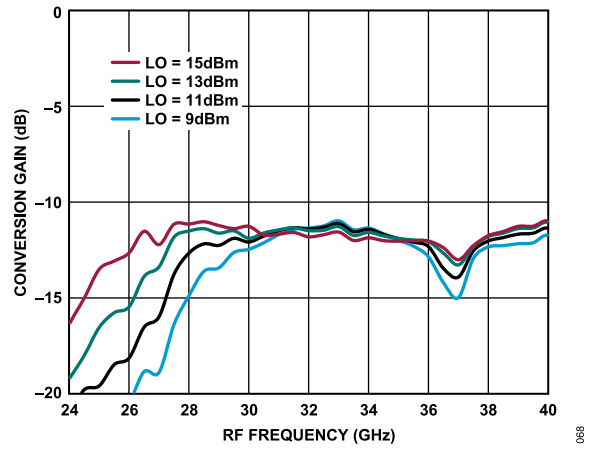

Figure 64. Conversion Gain vs. RF Frequency at Various LO Power Levels, $T_A = 25^\circ\text{C}$

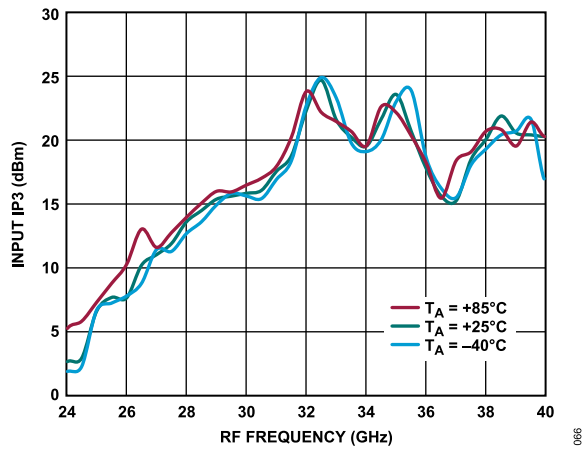

Figure 62. Input IP3 vs. RF Frequency at Various Temperatures, LO = 13 dBm

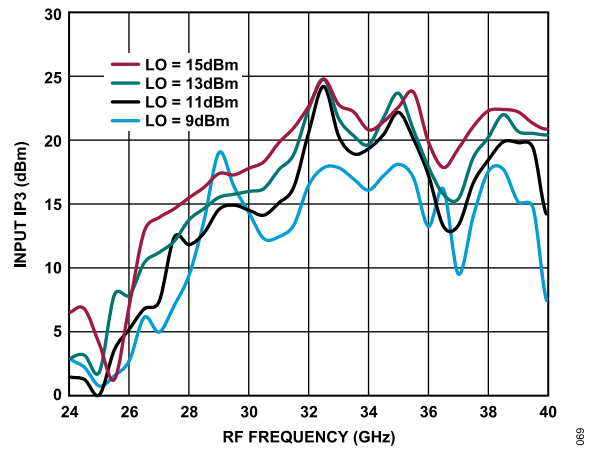

Figure 65. Input IP3 vs. RF Frequency at Various LO Power Levels, $T_A = 25^\circ\text{C}$

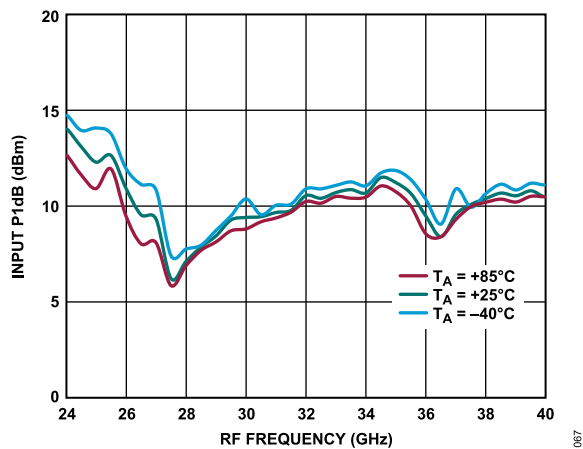

Figure 63. Input P1dB vs. RF Frequency at Various Temperatures, LO = 13 dBm

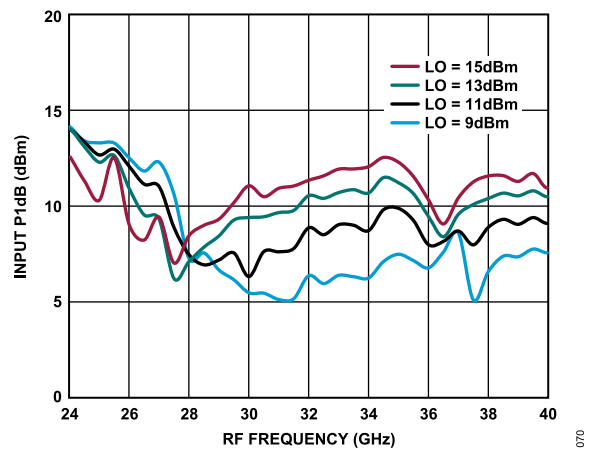

Figure 66. Input P1dB vs. RF Frequency at Various LO Power Levels, $T_A = 25^\circ\text{C}$

TYPICAL PERFORMANCE CHARACTERISTICS

Lower Sideband (High-Side LO)

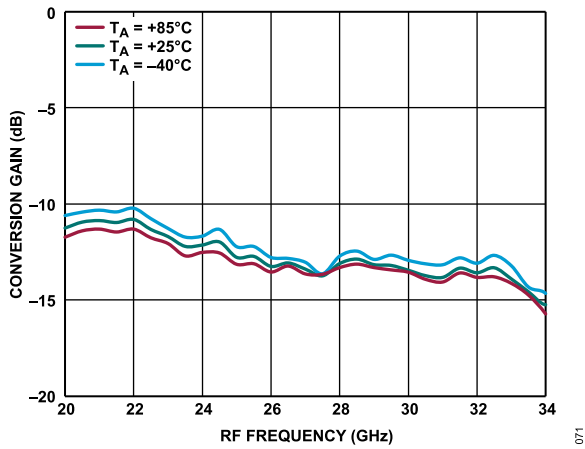

Figure 67. Conversion Gain vs. RF Frequency at Various Temperatures, LO = 13 dBm

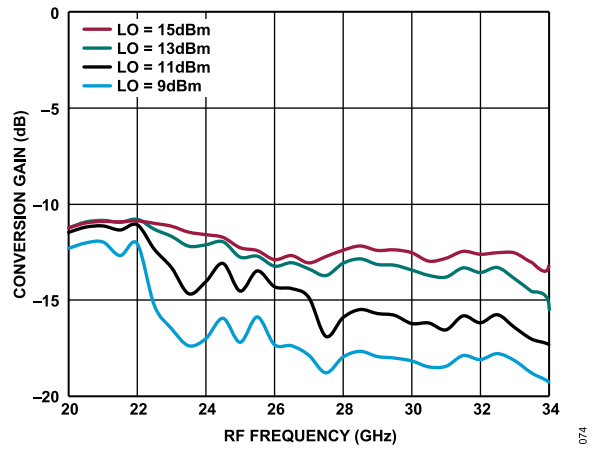

Figure 70. Conversion Gain vs. RF Frequency at Various LO Power Levels, $T_A = 25^\circ\text{C}$

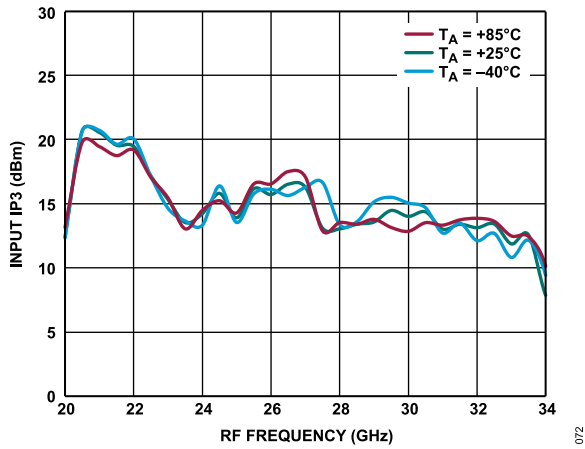

Figure 68. Input IP3 vs. RF Frequency at Various Temperatures, LO = 13 dBm

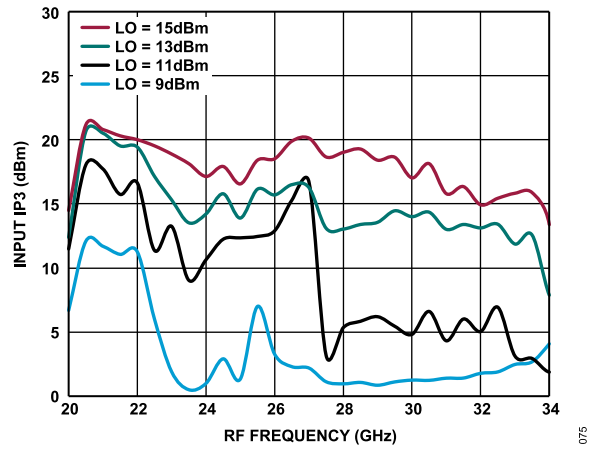

Figure 71. Input IP3 vs. RF Frequency at Various LO Power Levels, $T_A = 25^\circ\text{C}$

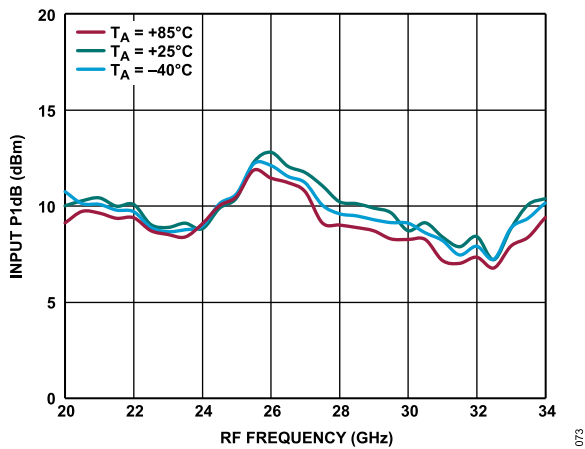

Figure 69. Input P1dB vs. RF Frequency at Various Temperatures, LO = 13 dBm

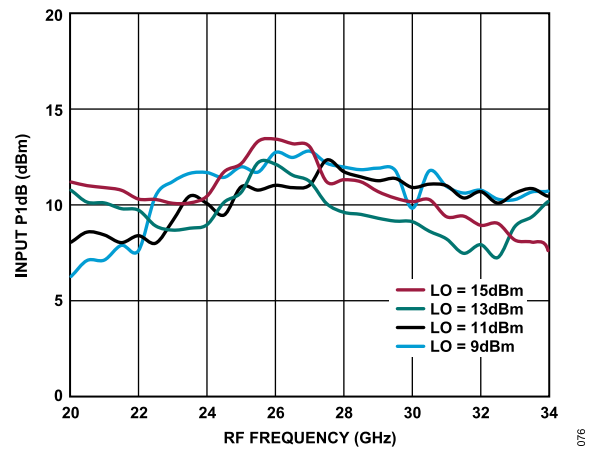

Figure 72. Input P1dB vs. RF Frequency at Various LO Power Levels, $T_A = 25^\circ\text{C}$

TYPICAL PERFORMANCE CHARACTERISTICS

UPCONVERTER PERFORMANCE, IF = 18 GHZ

Upper Sideband (Low-Side LO)

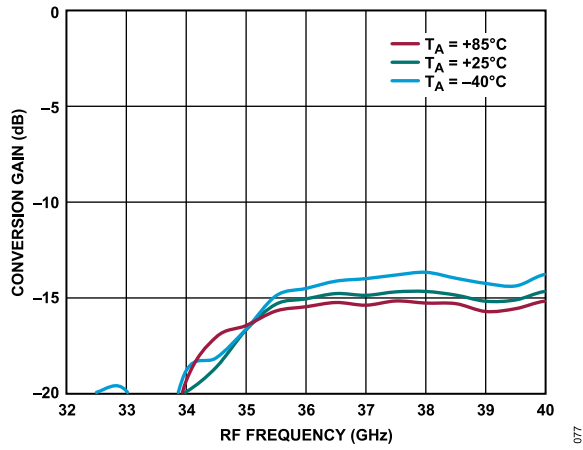

Figure 73. Conversion Gain vs. RF Frequency at Various Temperatures, LO = 13 dBm

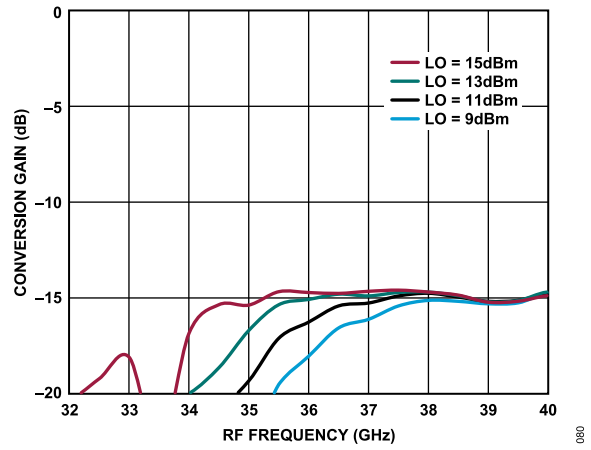

Figure 76. Conversion Gain vs. RF Frequency at Various LO Power Levels, $T_A = 25^\circ\text{C}$

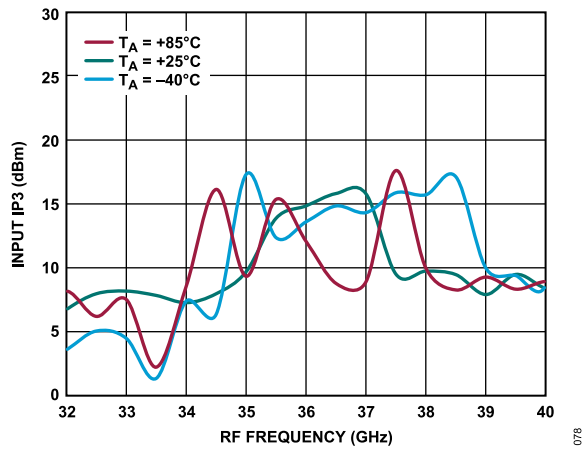

Figure 74. Input IP3 vs. RF Frequency at Various Temperatures, LO = 13 dBm

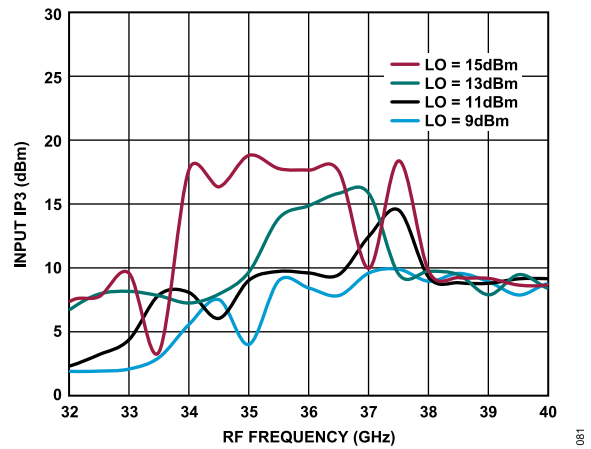

Figure 77. Input IP3 vs. RF Frequency at Various LO Power Levels, $T_A = 25^\circ\text{C}$

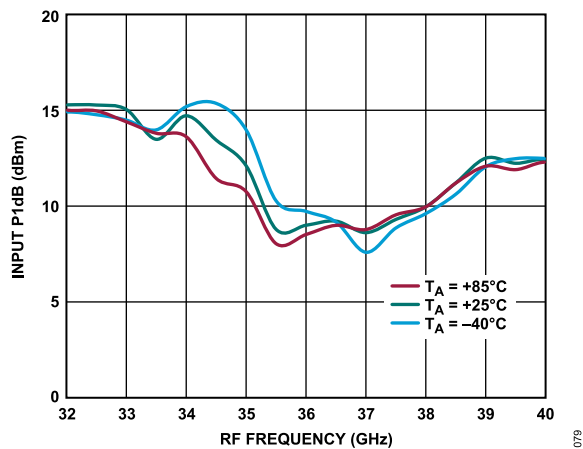

Figure 75. Input P1dB vs. RF Frequency at Various Temperatures, LO = 13 dBm

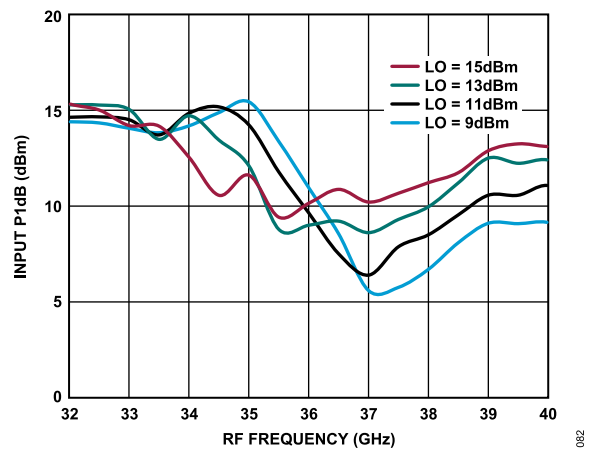

Figure 78. Input P1dB vs. RF Frequency at Various LO Power Levels, $T_A = 25^\circ\text{C}$

TYPICAL PERFORMANCE CHARACTERISTICS

Lower Sideband (High-Side LO)

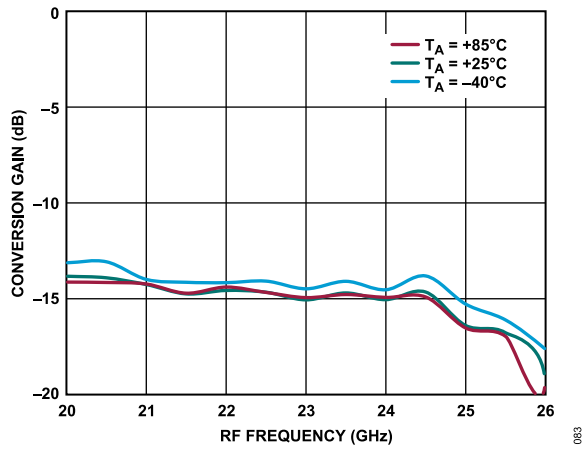

Figure 79. Conversion Gain vs. RF Frequency at Various Temperatures, LO = 13 dBm

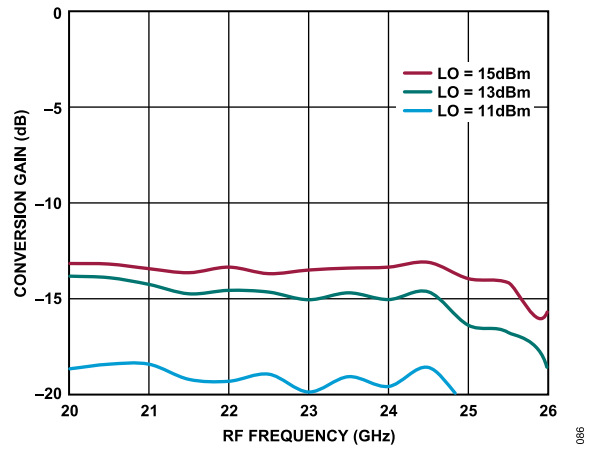

Figure 82. Conversion Gain vs. RF Frequency at Various LO Power Levels, $T_A = 25^\circ\text{C}$

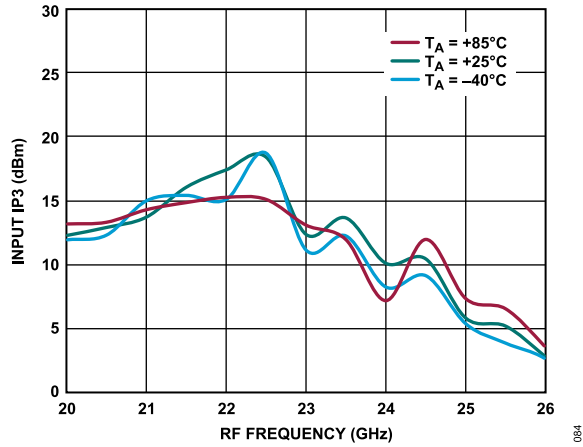

Figure 80. Input IP3 vs. RF Frequency at Various Temperatures, LO = 13 dBm

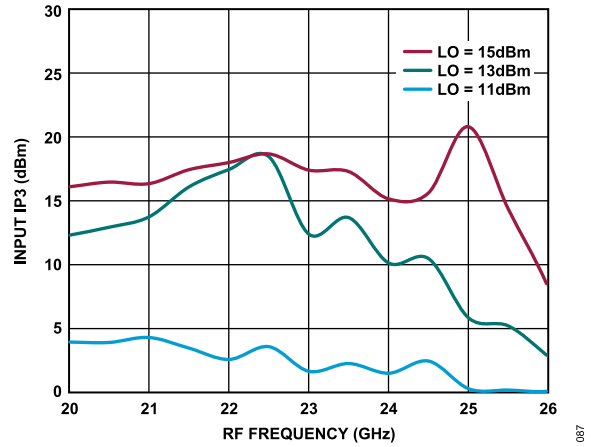

Figure 83. Input IP3 vs. RF Frequency at Various LO Power Levels, $T_A = 25^\circ\text{C}$

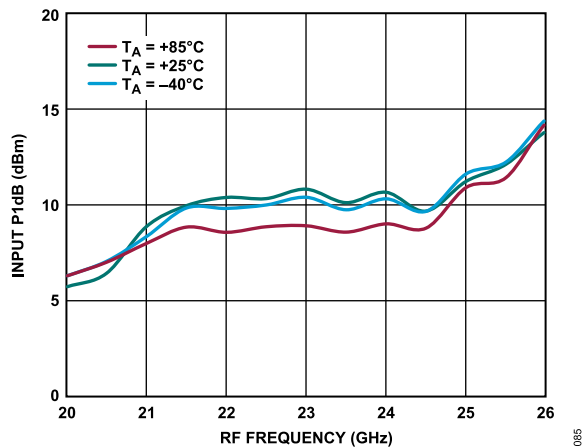

Figure 81. Input P1dB vs. RF Frequency at Various Temperatures, LO = 13 dBm

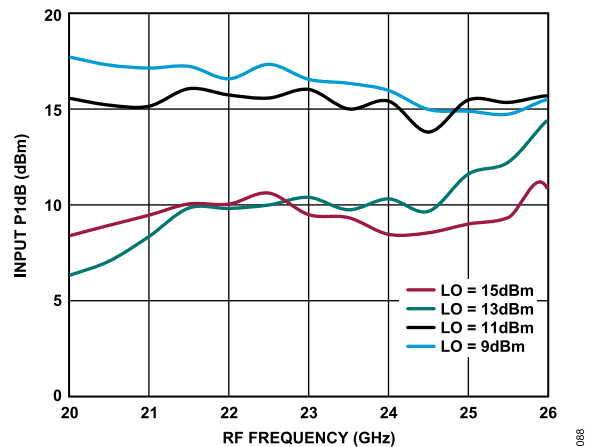

Figure 84. Input P1dB vs. RF Frequency at Various LO Power Levels, $T_A = 25^\circ\text{C}$

TYPICAL PERFORMANCE CHARACTERISTICS

ISOLATION AND RETURN LOSS

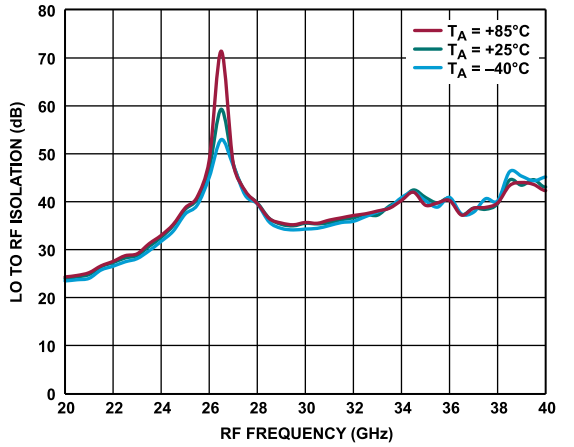

Figure 85. LO to RF Isolation vs. RF Frequency at Various Temperatures, LO = 13 dBm

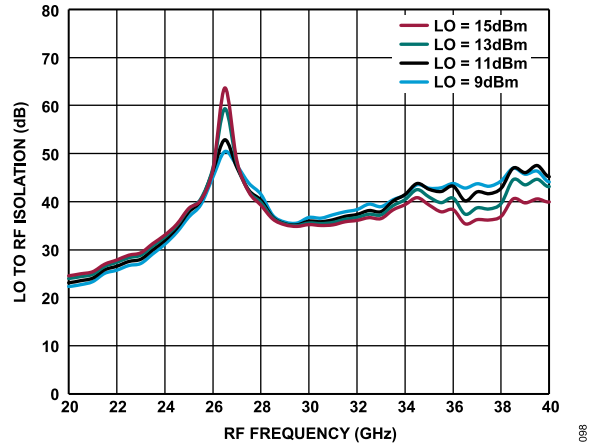

Figure 88. LO to RF Isolation vs. RF Frequency at Various LO Power Levels, $T_A = 25^\circ\text{C}$

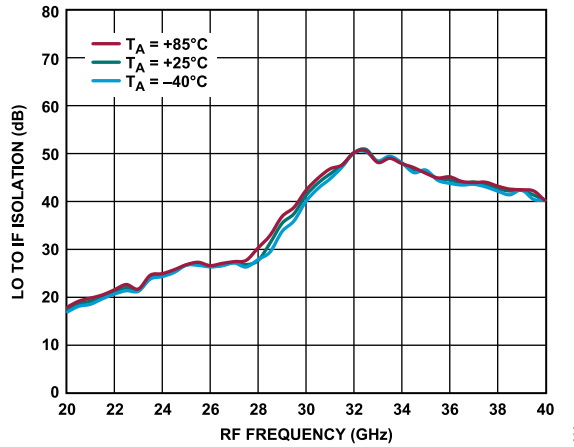

Figure 86. LO to IF Isolation vs. RF Frequency at Various Temperatures, LO = 13 dBm

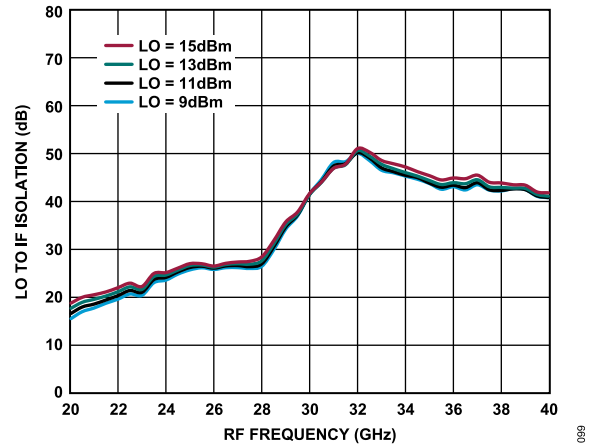

Figure 89. LO to IF Isolation vs. RF Frequency at Various LO Power Levels, $T_A = 25^\circ\text{C}$

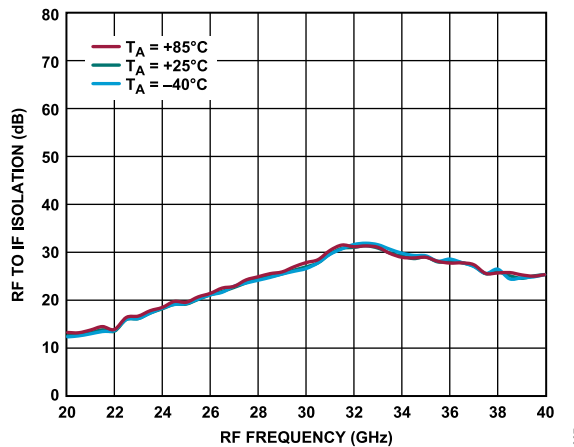

Figure 87. RF to IF Isolation vs. RF Frequency at Various Temperatures, LO = 13 dBm

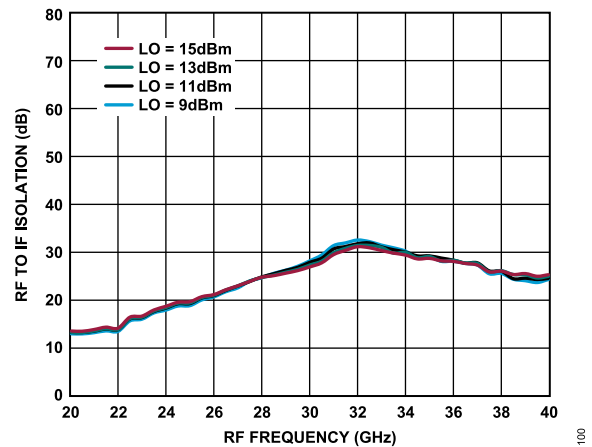

Figure 90. RF to IF Isolation vs. RF Frequency at Various LO Power Levels, $T_A = 25^\circ\text{C}$

TYPICAL PERFORMANCE CHARACTERISTICS

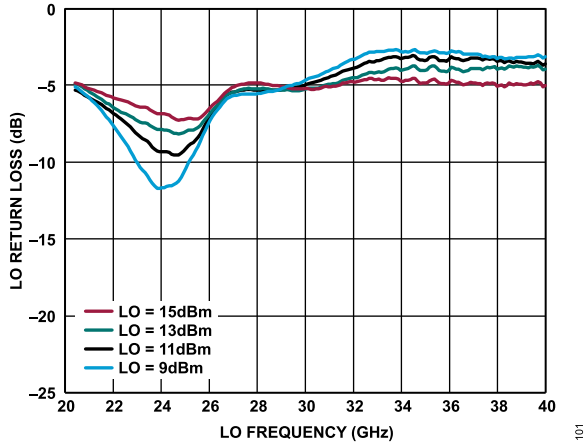

Figure 91. LO Return Loss vs. LO Frequency at Various LO Power Levels, $T_A = 25^\circ\text{C}$

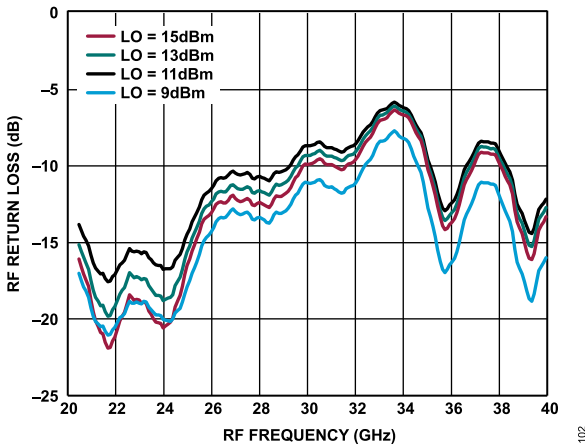

Figure 92. RF Return Loss vs. RF Frequency at Various LO Power Levels, $T_A = 25^\circ\text{C}$, LO = 15 GHz

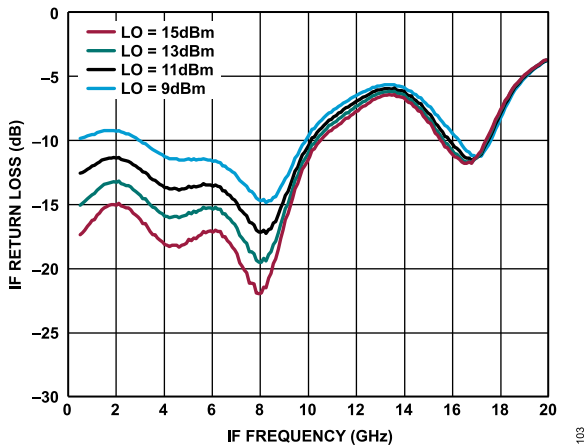

Figure 93. IF Return Loss vs. IF Frequency at Various LO Power Levels, $T_A = 25^\circ\text{C}$, LO = 15 GHz

TYPICAL PERFORMANCE CHARACTERISTICS

IF BANDWIDTH—DOWNCONVERTER

Upper Sideband, LO Frequency = 24 GHz

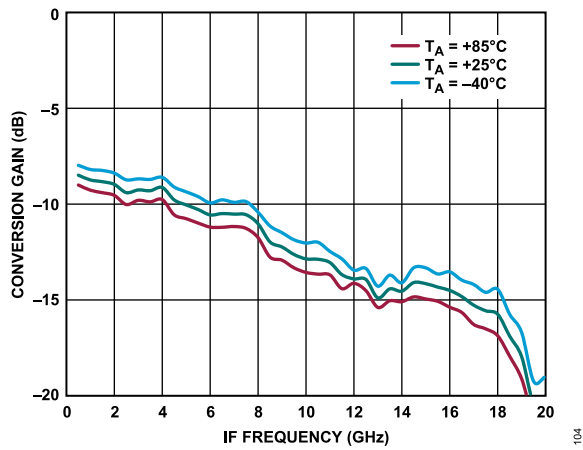

Figure 94. Conversion Gain vs. IF Frequency at Various Temperatures, LO = 13 dBm

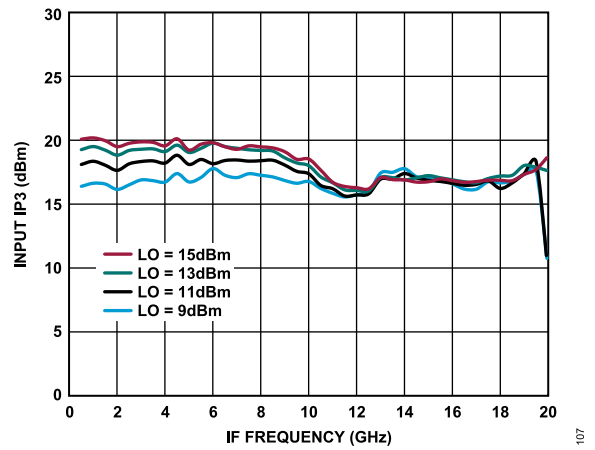

Figure 97. Input IP3 vs. IF Frequency at Various LO Power Levels, $T_A = 25^\circ\text{C}$

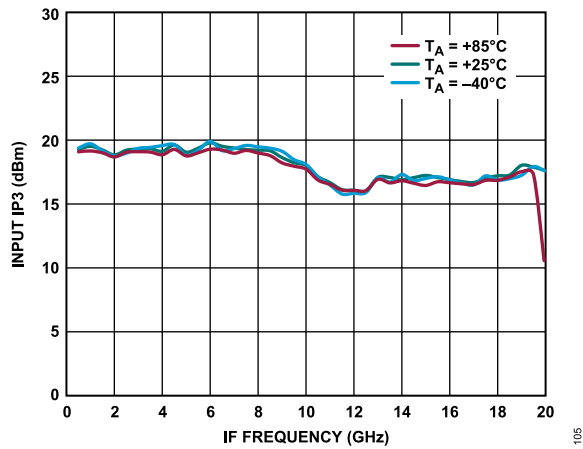

Figure 95. Input IP3 vs. IF Frequency at Various Temperatures, LO = 13 dBm

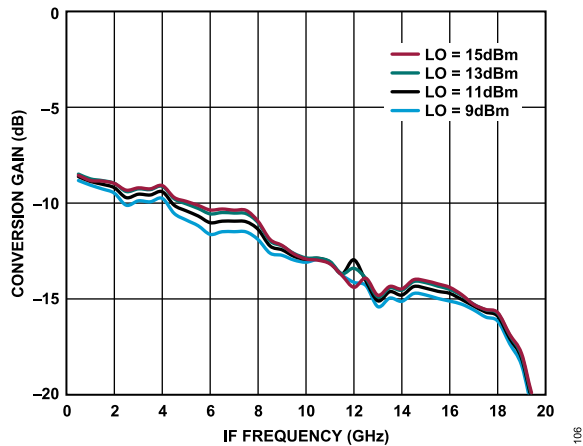

Figure 96. Conversion Gain vs. IF Frequency at Various LO Power Levels, $T_A = 25^\circ\text{C}$

TYPICAL PERFORMANCE CHARACTERISTICS

Lower Sideband, LO Frequency = 36 GHz

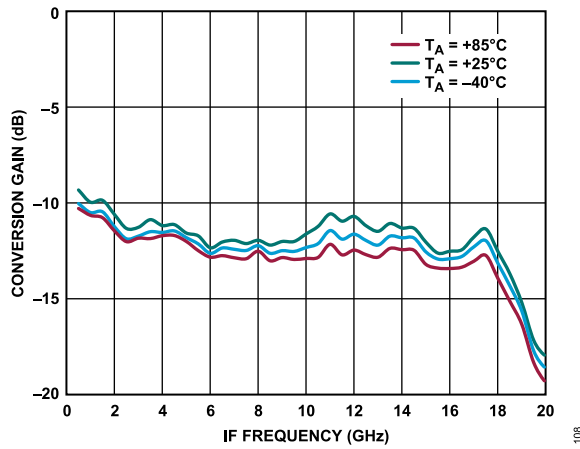

Figure 98. Conversion Gain vs. IF Frequency at Various Temperatures, LO = 13 dBm

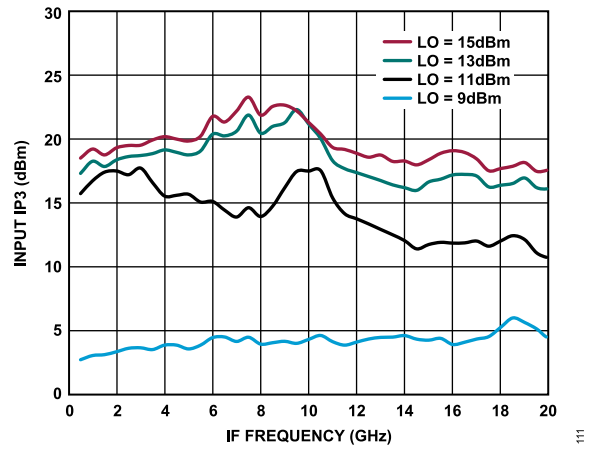

Figure 101. Input IP3 vs. IF Frequency at Various LO Power Levels, $T_A = 25^\circ\text{C}$

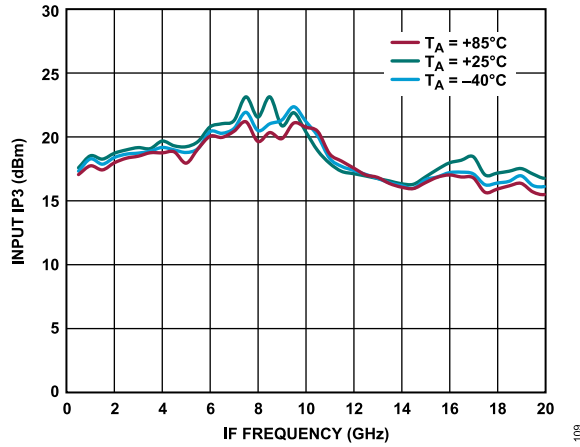

Figure 99. Input IP3 vs. IF Frequency at Various Temperatures, LO = 13 dBm

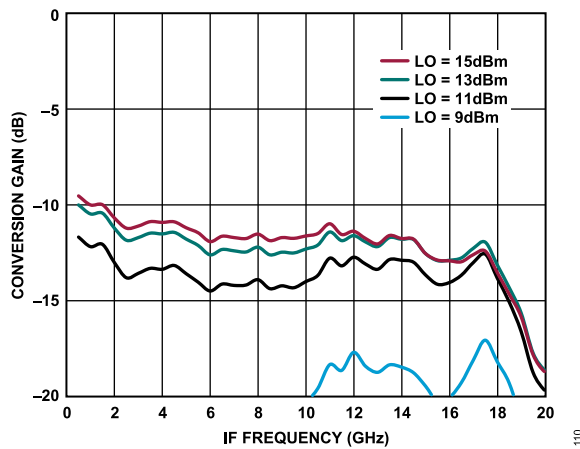

Figure 100. Conversion Gain vs. IF Frequency at Various LO Power Levels, $T_A = 25^\circ\text{C}$

TYPICAL PERFORMANCE CHARACTERISTICS

SPURIOUS PERFORMANCE

LO Harmonics

LO = 13 dBm, and all values in dBc are below the input LO level and measured at the RF port. N/A means not applicable.

Table 5. LO Harmonics at RF

LO Frequency (GHz)	N _{LO} Spur at RF Port (dBc)			
	1	2	3	4
24	40	33	N/A	N/A
28	36	N/A	N/A	N/A
30	36	N/A	N/A	N/A
32	38	N/A	N/A	N/A
36	38	N/A	N/A	N/A
40	48	N/A	N/A	N/A

LO = 13 dBm, and all values in dBc are below the input LO level and measured at the IF port. N/A means not applicable.

Table 6. LO Harmonics at IF

LO Frequency (GHz)	N _{LO} Spur at IF Port (dBc)			
	1	2	3	4
24	27	68	N/A	N/A
28	37	N/A	N/A	N/A
30	47	N/A	N/A	N/A
32	50	N/A	N/A	N/A
36	45	N/A	N/A	N/A
40	43	N/A	N/A	N/A

M × N Spurious Outputs

Downconversion, Upper Sideband

Spur values are $(M \times RF) - (N \times LO)$. RF = 25 GHz, LO = 24 GHz, RF power = -10 dBm, and LO power = +13 dBm. Mixer spurious products are measured in dBc from the IF output power level. N/A means not applicable.

M × RF		N × LO				
		0	1	2	3	4
M × RF	1	11	0	34	38	N/A
	2	61	63	62	56	66
	3	N/A	N/A	75	67	76
	4	N/A	N/A	N/A	74	80

Downconversion, Lower Sideband

Spur values are $(M \times RF) - (N \times LO)$. RF = 35 GHz, LO = 36 GHz, RF power = -10 dBm, and LO power = +13 dBm. Mixer spurious products are measured in dBc from the IF output power level. N/A means not applicable.

M × RF		N × LO				
		0	1	2	3	4
M × RF	1	19	0	35	0	N/A
	2	N/A	70	54	67	N/A
	3	N/A	N/A	67	65	N/A
	4	N/A	N/A	N/A	73	N/A

Upconversion, Upper Sideband

Spur values are $(M \times IF_{IN}) + (N \times LO)$. IF_{IN} = 1 GHz, LO = 24 GHz, IF_{IN} power = -10 dBm, and LO power = +13 dBm. Mixer spurious products are measured in dBc from the RF output power level. N/A means not applicable.

M × IF _{IN}		N × LO				
		0	1	2	3	4
M × IF _{IN}	-4	82	76	66	N/A	N/A
	-3	84	69	68	N/A	N/A
	-2	57	49	51	N/A	N/A
	-1	16	0	31	N/A	N/A
	0	0	7	1	N/A	N/A
	+1	16	0	34	N/A	N/A
	+2	57	49	53	N/A	N/A
	+3	85	73	N/A	N/A	N/A
	+4	82	76	N/A	N/A	N/A

Upconversion, Lower Sideband

Spur values are $(M \times IF_{IN}) + (N \times LO)$. IF_{IN} = 1 GHz, LO = 36 GHz, IF_{IN} power = -10 dBm, and LO power = +13 dBm. Mixer spurious products are measured in dBc from the RF output power level. N/A means not applicable.

M × IF _{IN}		N × LO				
		0	1	2	3	4
M × IF _{IN}	-4	80	72	N/A	N/A	N/A
	-3	83	59	N/A	N/A	N/A
	-2	55	46	N/A	N/A	N/A
	-1	14	0	N/A	N/A	N/A
	0	0	5	N/A	N/A	N/A
	+1	14	0	N/A	N/A	N/A
	+2	55	47	N/A	N/A	N/A
	+4	79	64	N/A	N/A	N/A

THEORY OF OPERATION

The HMC560A is a GaAs, MMIC, double balanced mixer that can be used as an upconverter or a downconverter from 24 GHz to 38 GHz. A single HMC560A can replace multiple narrow-band mixers in a design with a small printed circuit board (PCB) footprint.

When used as a downconverter, the HMC560A downconverts RF between 24 GHz and 38 GHz to IF values between dc and 18 GHz.

When used as an upconverter, the mixer upconverts IF values between dc and 18 GHz to RF values between 24 GHz and 38 GHz.

The mixer performs well with LO drive level values of 13 dBm or greater and provides excellent LO to RF and LO to IF suppression due to optimized balun structures.

APPLICATIONS INFORMATION

TYPICAL APPLICATION CIRCUIT

Figure 102 shows the typical application circuit for the HMC560A. The HMC560A is a passive device and does not require any external components. The LO and RF pads are internally ac-coupled. When IF operation is not required until dc, it is recommended to use an ac-coupled capacitor at the IF port if dc operation is not required

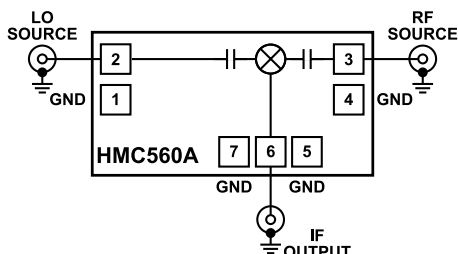

Figure 102. Typical Application Circuit

MOUNTING AND BONDING TECHNIQUES

Attach the die directly to the ground plane eutectically or with conductive epoxy. To bring RF to and from the chip, 50 Ω microstrip transmission lines on 0.127 mm (0.005") thick alumina, thin film substrates are recommended (see Figure 103).

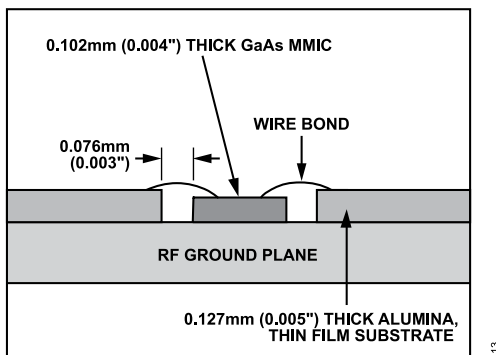

Figure 103. Bonding RF Pads to 5 mil Substrate

If using 0.254 mm (0.010") thick alumina, thin film substrates, raise the die 0.150 mm (0.006") so that the surface of the die is coplanar with the surface of the substrate. A way to accomplish this is to attach the 0.102 mm (0.004") thick die to a 0.150 mm (0.006") thick molybdenum heat spreader (moly tab), which is then attached to the ground plane (see Figure 104). To minimize bond wire length, place microstrip substrates as close to the die as possible. Typical die to substrate spacing is 0.076 mm (0.003").

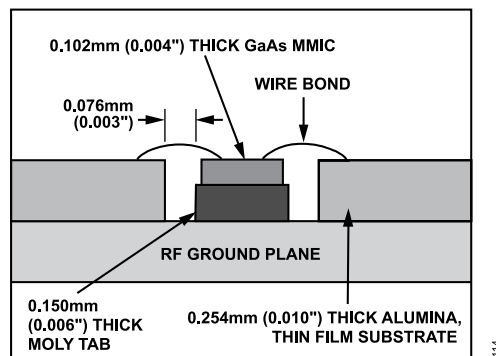

Figure 104. Bonding RF Pads to 10 mil Substrate

HANDLING PRECAUTIONS

To avoid permanent damage to the device, follow the precautions in the following [Storage](#), [Cleanliness](#), [Static Sensitivity](#), [Transients](#), and [General Handling](#) sections.

Storage

All bare dice are placed in either waffle- or gel-based ESD protective containers and then sealed in an ESD protective bag for shipment. After opening the sealed ESD protective bag, store all dice in a dry nitrogen environment.

Cleanliness

Handle the chips in a clean environment. Do not attempt to clean the chip using liquid cleaning systems.

Static Sensitivity

Follow ESD precautions to protect against ESD strikes.

Transients

Suppress instrument and bias supply transients while bias is applied. Use shielded signal and bias cables to minimize inductive pickup.

General Handling

Handle the chip along the edges with a vacuum collet or with a sharp pair of bent tweezers. The surface of the chip has fragile air bridges. Do not touch the chip with a vacuum collet, tweezers, or fingers.

APPLICATIONS INFORMATION

MOUNTING

The chip is back metallized and can be die mounted with gold (Au)/tin (Sn) eutectic preforms or with electrically conductive epoxy. The mounting surface must be clean and flat.

Eutectic Die Attach

An 80/20 gold and tin preform is recommended with a work surface temperature of 255°C and a tool temperature of 265°C. When hot 90/10 nitrogen(N)/hydrogen (H) gas is applied, the tool tip temperature must be 290°C. Do not expose the chip to a temperature greater than 320°C for more than 20 seconds. No more than 3 seconds of scrubbing is required for attachment.

Epoxy Die Attach

Apply a minimum amount of epoxy to the mounting surface so that a thin epoxy fillet is observed around the perimeter of the chip when

the chip is placed into position. Cure epoxy per the schedule of the manufacturer.

WIRE BONDING

Ball or wedge bond with 0.025 mm (0.00098") diameter pure gold wire is recommended. Thermosonic wire bonding with a nominal stage temperature of 150°C and a ball bonding force of 40 grams to 50 grams, or a wedge bonding force of 18 grams to 22 grams, is recommended. Use the minimum level of ultrasonic energy to achieve reliable wire bonds. Wire bonds must begin on the chip and terminate on the package or substrate. All bonds must be as short as possible <0.31 mm (0.01220").

OUTLINE DIMENSIONS

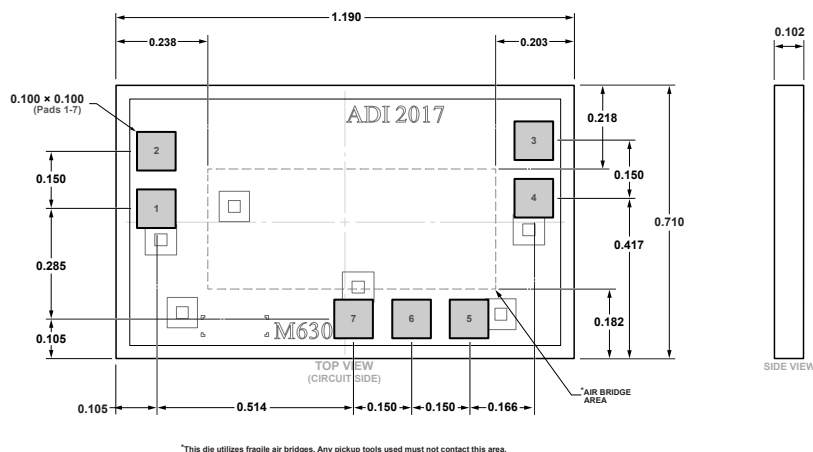

**Figure 105. 7-Pad Bare Die [CHIP]
(C-7-10)**
Dimensions shown in millimeters

Updated: March 22, 2023

ORDERING GUIDE

Model ¹	Temperature Range	Package Description	Package Option
HMC560A	-40°C to +85°C	CHIPS OR DIE	C-7-10
HMC560A-SX	-40°C to +85°C	CHIPS OR DIE	C-7-10

¹ The HMC560A and HMC560A-SX are RoHS compliant parts.