

EPC2202 - Automotive 80 V (D-S) Enhancement Mode Power Transistor

V_{DS} , 80 V

$R_{DS(on)}$, 17 m Ω

I_D , 18 A

AEC-Q101

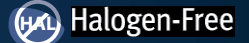

Gallium Nitride's exceptionally high electron mobility and low temperature coefficient allows very low $R_{DS(on)}$, while its lateral device structure and majority carrier diode provide exceptionally low Q_G and zero Q_{RR} . The end result is a device that can handle tasks where very high switching frequency, and low on-time are beneficial as well as those where on-state losses dominate.

Maximum Ratings

PARAMETER		VALUE	UNIT
V_{DS}	Drain-to-Source Voltage (Continuous)	80	V
I_D	Continuous ($T_A = 25^\circ\text{C}$, $R_{\theta JA} = 12^\circ\text{C/W}$)	18	A
	Pulsed (25°C , $T_{PULSE} = 300 \mu\text{s}$)	75	
V_{GS}	Gate-to-Source Voltage	5.75	V
	Gate-to-Source Voltage	-4	
T_J	Operating Temperature	-40 to 150	$^\circ\text{C}$
T_{STG}	Storage Temperature	-40 to 150	

Thermal Characteristics

PARAMETER		TYP	UNIT
$R_{\theta JC}$	Thermal Resistance, Junction-to-Case	2	$^\circ\text{C/W}$
$R_{\theta JB}$	Thermal Resistance, Junction-to-Board	4	
$R_{\theta JA}$	Thermal Resistance, Junction-to-Ambient (Note 1)	69	

Note 1: $R_{\theta JA}$ is determined with the device mounted on one square inch of copper pad, single layer 2 oz copper on FR4 board. See https://epc-co.com/epc/documents/product-training/Appnote_Thermal_Performance_of_eGaN_FETs.pdf for details.

Static Characteristics ($T_J = 25^\circ\text{C}$ unless otherwise stated)

PARAMETER		TEST CONDITIONS	MIN	TYP	MAX	UNIT
BV_{DSS}	Drain-to-Source Voltage	$V_{GS} = 0 \text{ V}$, $I_D = 300 \mu\text{A}$	80			V
I_{DSS}	Drain-Source Leakage	$V_{DS} = 64 \text{ V}$, $V_{GS} = 0 \text{ V}$		20	250	μA
I_{GSS}	Gate-to-Source Forward Leakage	$V_{GS} = 5 \text{ V}$		0.01	3	mA
	Gate-to-Source Reverse Leakage	$V_{GS} = -4 \text{ V}$		0.01	0.25	mA
$V_{GS(TH)}$	Gate Threshold Voltage	$V_{DS} = V_{GS}$, $I_D = 3 \text{ mA}$	0.8	1.4	2.5	V
$R_{DS(on)}$	Drain-Source On Resistance	$V_{GS} = 5 \text{ V}$, $I_D = 11 \text{ A}$		12	17	$\text{m}\Omega$
V_{SD}	Source-Drain Forward Voltage	$I_S = 0.5 \text{ A}$, $V_{GS} = 0 \text{ V}$		1.8		V

All measurements were done with substrate connected to source.

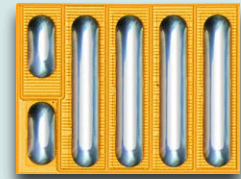

EPC2202 eGaN® FETs are supplied only in passivated die form with solder bars. Die size: 2.1 mm x 1.6 mm

Applications

- Lidar/Pulsed Power Applications
- High Power Density DC-DC Converters
- Class-D Audio
- High Intensity Headlamps

Benefits

- Ultra High Efficiency
- Ultra Low $R_{DS(on)}$
- Ultra Low Q_G
- Ultra Small Footprint



Dynamic Characteristics ($T_j = 25^\circ\text{C}$ unless otherwise stated)

PARAMETER		TEST CONDITIONS	MIN	TYP	MAX	UNIT
C_{ISS}	Input Capacitance	$V_{DS} = 50\text{ V}, V_{GS} = 0\text{ V}$		345	415	pF
C_{RSS}	Reverse Transfer Capacitance			3		
C_{OSS}	Output Capacitance			230	345	
$C_{OSS(ER)}$	Effective Output Capacitance, Energy Related (Note 2)	$V_{DS} = 0\text{ to }50\text{ V}, V_{GS} = 0\text{ V}$		279		
$C_{OSS(TR)}$	Effective Output Capacitance, Time Related (Note 3)			352		
R_G	Gate Resistance			0.4		Ω
Q_G	Total Gate Charge	$V_{DS} = 50\text{ V}, V_{GS} = 5\text{ V}, I_D = 11\text{ A}$		3.2	4	nC
Q_{GS}	Gate-to-Source Charge	$V_{DS} = 50\text{ V}, I_D = 11\text{ A}$		1		
Q_{GD}	Gate-to-Drain Charge			0.55		
$Q_{G(TH)}$	Gate Charge at Threshold			0.7		
Q_{OSS}	Output Charge	$V_{DS} = 50\text{ V}, V_{GS} = 0\text{ V}$		18	27	
Q_{RR}	Source-Drain Recovery Charge			0		

All measurements were done with substrate connected to source.

Note 2: $C_{OSS(ER)}$ is a fixed capacitance that gives the same stored energy as C_{OSS} while V_{DS} is rising from 0 to 62.5% BV_{DSS} .

Note 3: $C_{OSS(TR)}$ is a fixed capacitance that gives the same charging time as C_{OSS} while V_{DS} is rising from 0 to 62.5% BV_{DSS} .

Figure 1: Typical Output Characteristics at 25°C

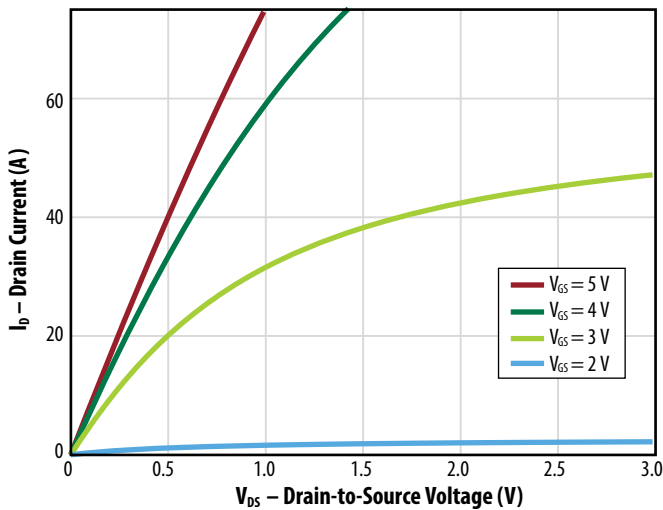

Figure 2: Transfer Characteristics

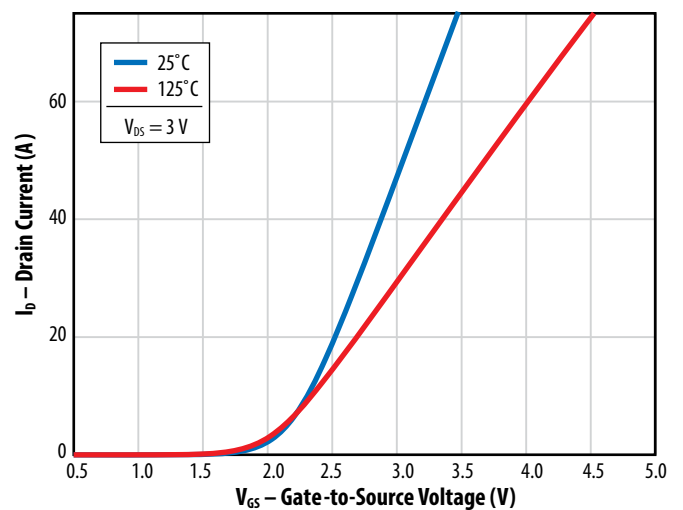

Figure 3: $R_{DS(on)}$ vs. V_{GS} for Various Currents

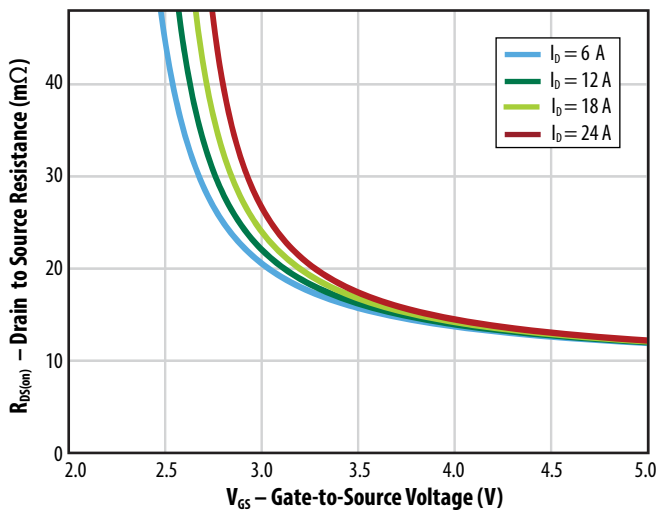

Figure 4: $R_{DS(on)}$ vs. V_{GS} for Various Temperatures

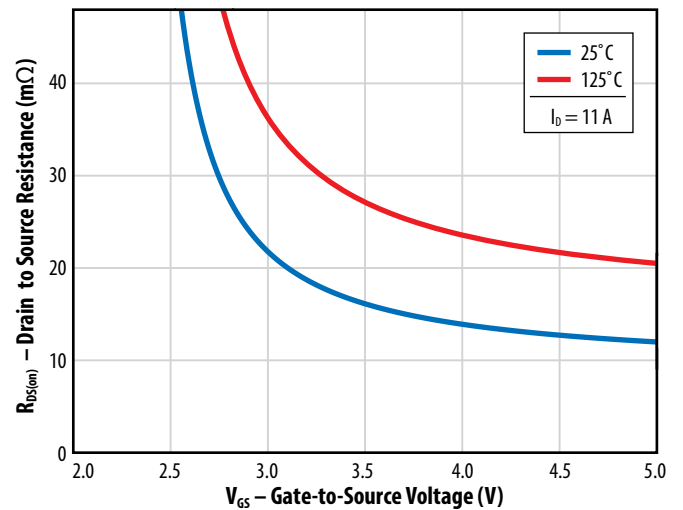

Figure 5a: Capacitance (Linear Scale)

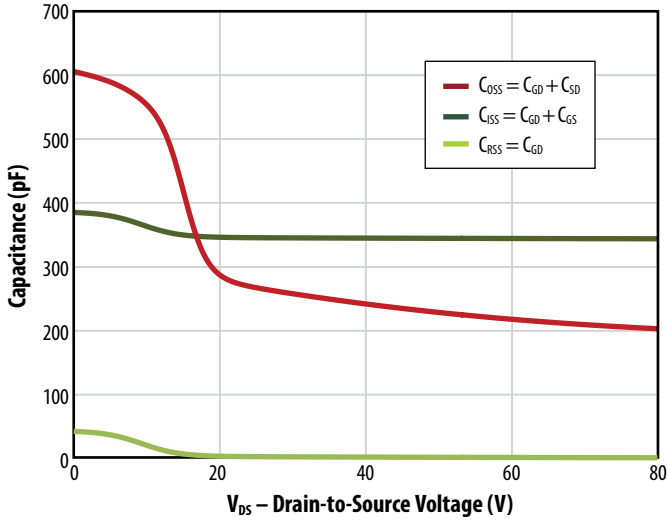

Figure 5b: Capacitance (Log Scale)

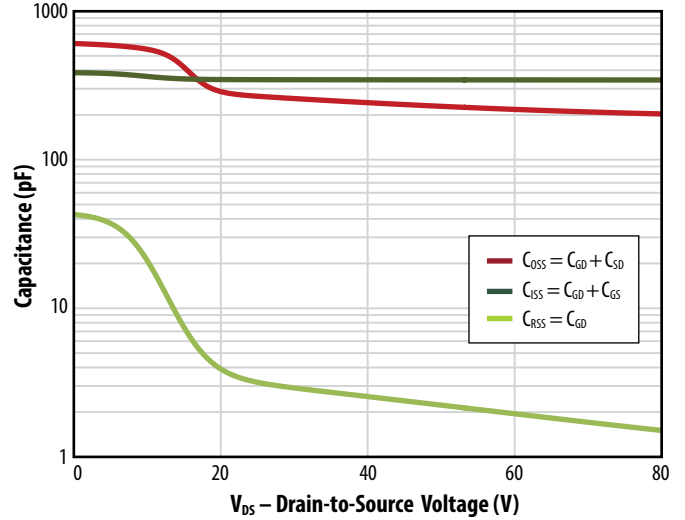

Figure 5c: Output Charge and C_{OSS} Stored Energy

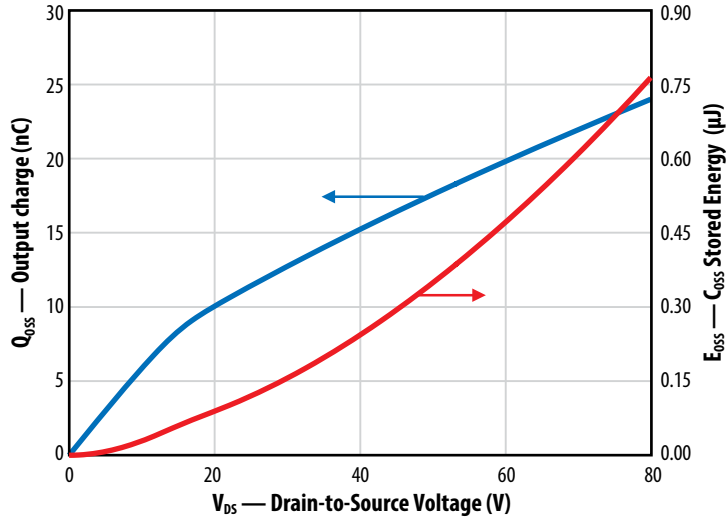

Figure 6: Gate Charge

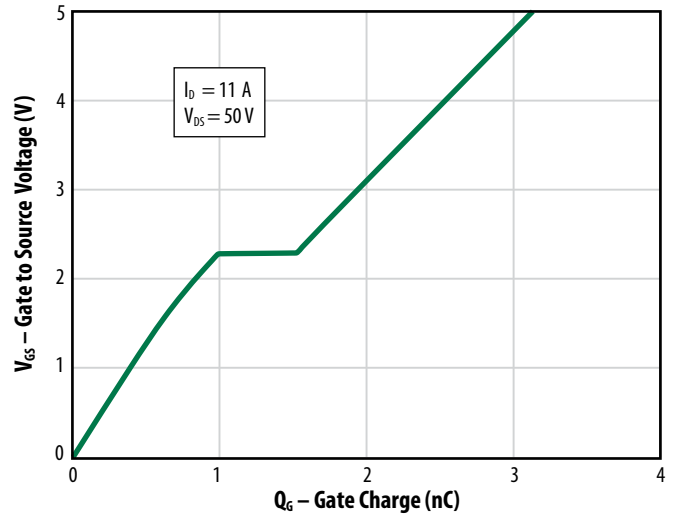

Figure 7: Reverse Drain-Source Characteristics

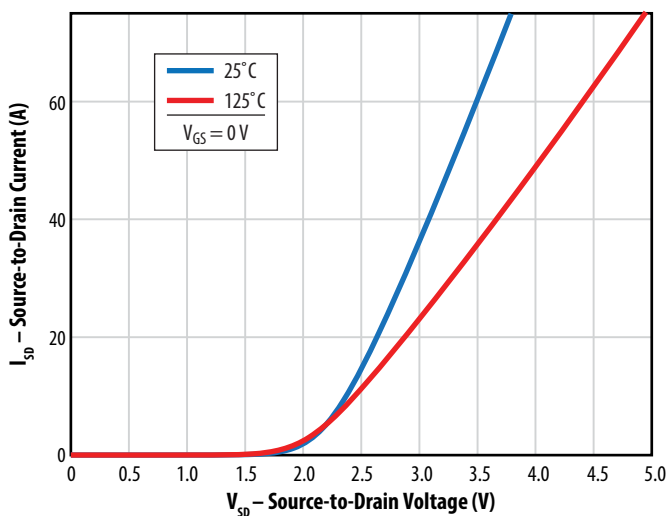

Figure 8: Normalized On-State Resistance vs. Temperature

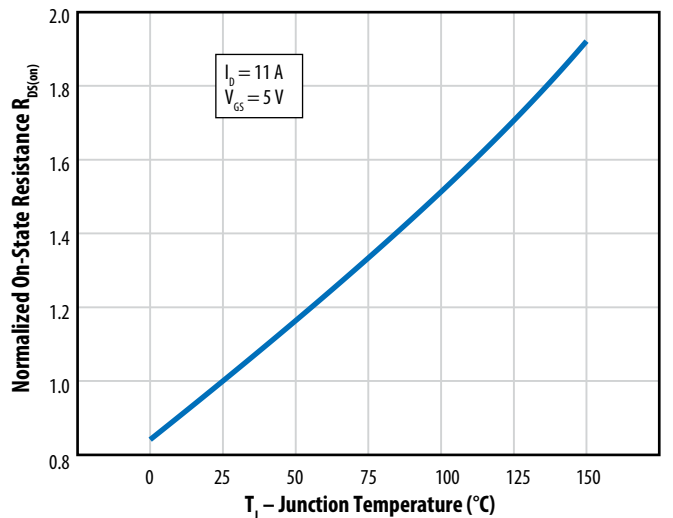

Figure 9: Normalized Threshold Voltage vs. Temperature

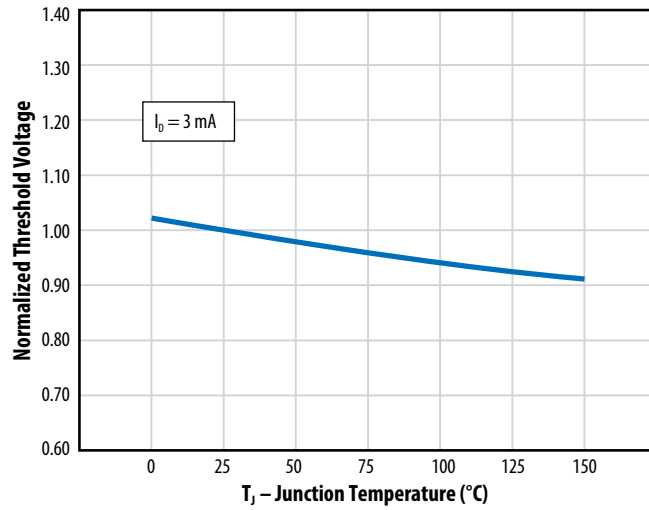

Figure 10: Transient Thermal Response Curves

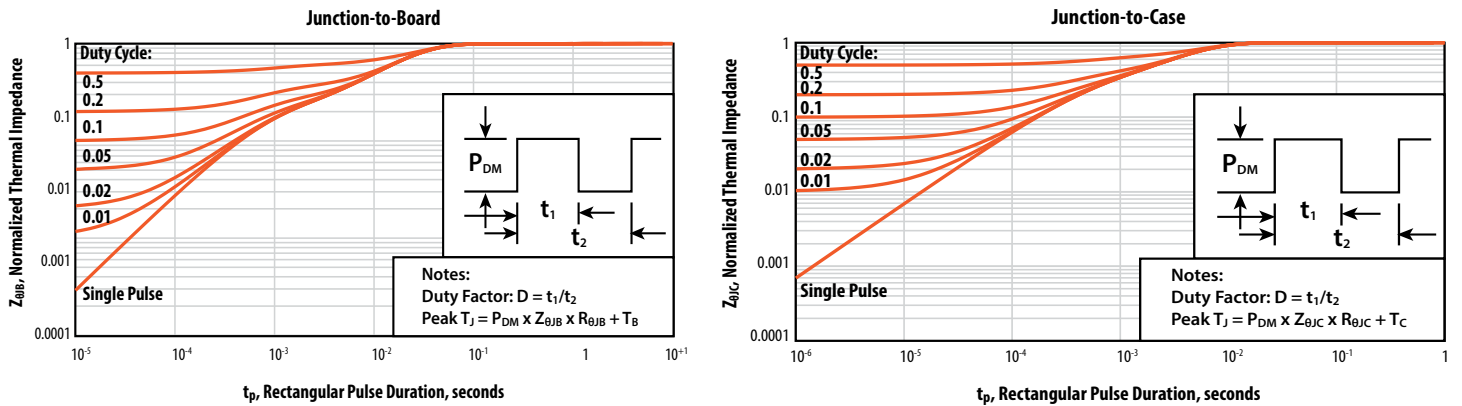
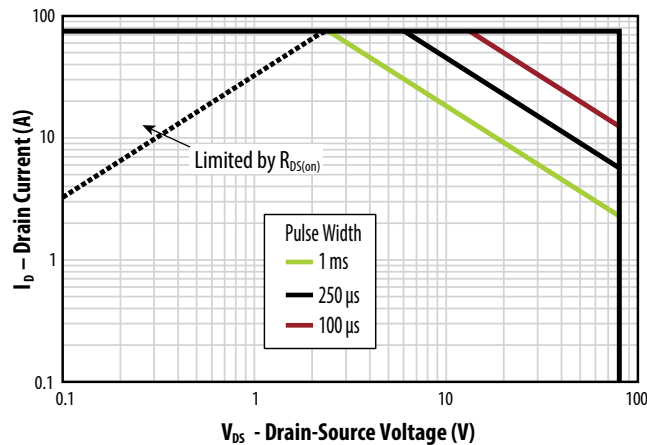
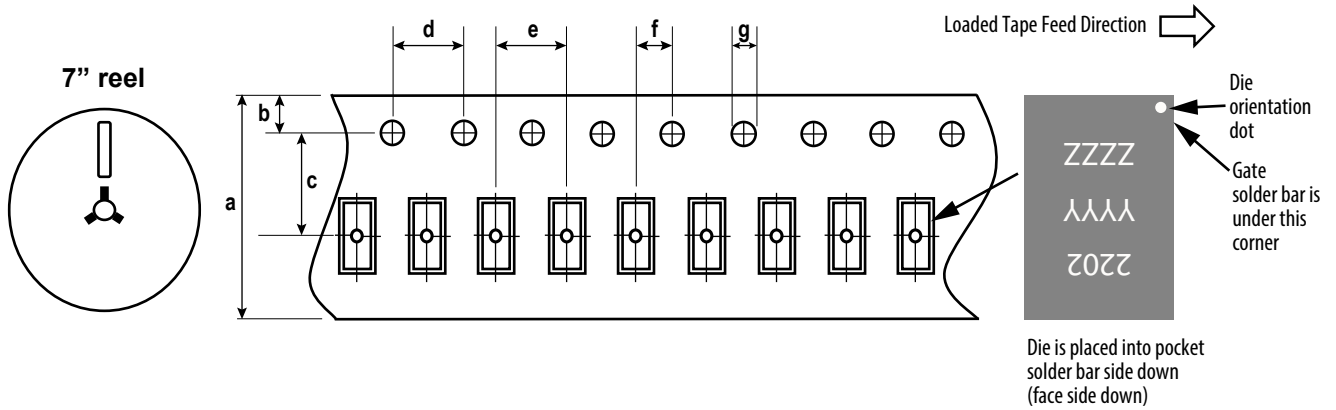

Figure 11: Safe Operating Area



TAPE AND REEL CONFIGURATION

4mm pitch, 8mm wide tape on 7" reel



Dimension (mm)	EPC2202 (note 1)		
	target	min	max
a	8.00	7.90	8.30
b	1.75	1.65	1.85
c (see note)	3.50	3.45	3.55
d	4.00	3.90	4.10
e	4.00	3.90	4.10
f (see note)	2.00	1.95	2.05
g	1.5	1.5	1.6

Note 1: MSL 1 (moisture sensitivity level 1) classified according to IPC/JEDEC industry standard.
 Note 2: Pocket position is relative to the sprocket hole measured as true position of the pocket, not the pocket hole.

DIE MARKINGS

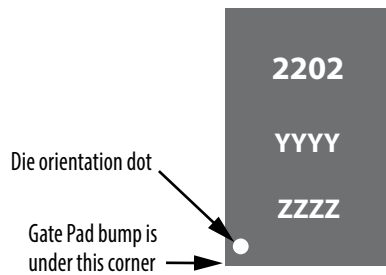

Part Number	Laser Markings		
	Part # Marking Line 1	Lot_Date Code Marking line 2	Lot_Date Code Marking Line 3
EPC2202	2202	YYYY	ZZZZ

DIE OUTLINE

Solder Bar View

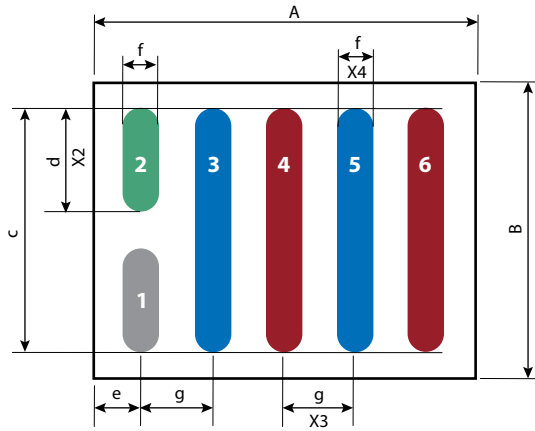

Side View

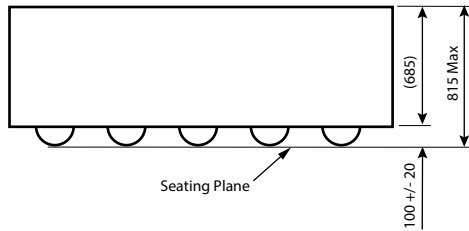

DIM	MICROMETERS		
	MIN	Nominal	MAX
A	2076	2106	2136
B	1602	1632	1662
c	1379	1382	1385
d	577	580	583
e	235	250	265
f	195	200	205
g	400	400	400

Pad no. 1 is Gate;
 Pads no. 3, 5 are Drain;
 Pads no. 4, 6 are Source;
 Pad no. 2 is Substrate.*

*Substrate pin should be connected to Source

RECOMMENDED LAND PATTERN

(units in μm)

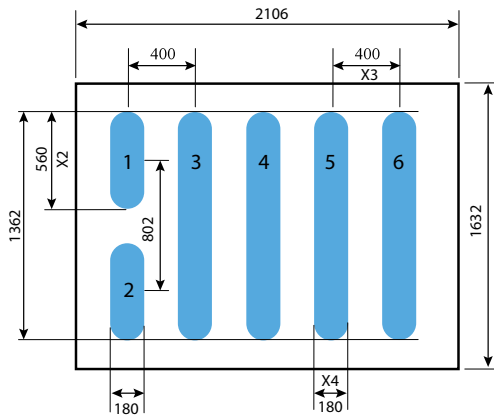

The land pattern is solder mask defined.

Pad no. 1 is Gate;
 Pads no. 3, 5 are Drain;
 Pads no. 4, 6 are Source;
 Pad no. 2 is Substrate.*

*Substrate pin should be connected to Source

RECOMMENDED STENCIL DRAWING

(measurements in μm)

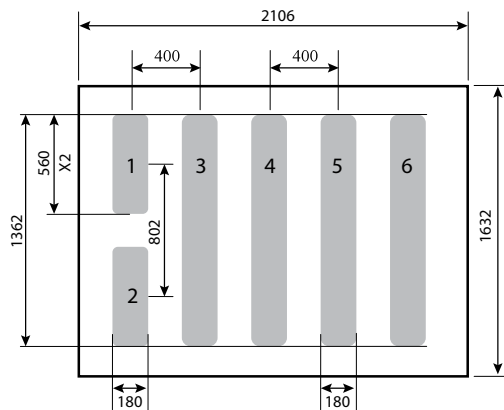

Recommended stencil should be 4mil (100 μm) thick, must be laser cut, opening per drawing. The corner has a radius of R60

Intended for use with SAC305 Type 3 solder, reference 88.5% metals content.

Additional assembly resources available at <https://epc-co.com/epc/DesignSupport/AssemblyBasics.aspx>

Efficient Power Conversion Corporation (EPC) reserves the right to make changes without further notice to any products herein to improve reliability, function or design. EPC does not assume any liability arising out of the application or use of any product or circuit described herein; neither does it convey any license under its patent rights, nor the rights of others.

eGaN® is a registered trademark of Efficient Power Conversion Corporation.
 EPC Patent Listing: epc-co.com/epc/AboutEPC/Patents.aspx

Information subject to change without notice.
 Revised April, 2021