

TPS92682EVM-069 CV 2-Phase Boost Controller Evaluation Module

User's Guide



Literature Number: SLUUBX9A
March 2019–Revised August 2019

1	Trademarks	7
2	Description	7
	2.1 Typical Applications	7
	2.2 Warnings	8
	2.3 Connector Description	8
3	REACH Compliance	9
4	Performance Specifications	9
5	Performance Data and Typical Characteristic Curves	10
	5.1 2-phase CV BOOST SW-Node Voltage Waveform	11
	5.2 Startup Waveforms	11
	5.3 Load Transient	12
6	Schematic, PCB Layout, and Bill of Materials	13
	6.1 Schematic	13
	6.2 Layout	14
	6.3 Bill of Materials	17
7	Software	20
	7.1 Demonstration Kit Software Installation for MSP-EXP432E401Y LaunchPad Board	20
	7.2 Installation Error Recovery	28
	7.3 Programming the MSP-EXP432E401Y LaunchPad Board	29
8	TPS92682EVM-069 Power UP and Operation	34
	8.1 SPI Command	36
	8.2 GUI Devices Window	37
	Revision History	40

List of Figures

1	Connection diagram	8
2	Efficiency vs Output Power	10
3	CV boost 2-phase SW-node voltage	11
4	Soft-start timing	11
5	Softstart waveforms for	11
6	CV 2-phase boost load transient	12
7	TPS92682EVM-069 Schematic	13
8	TPS92682EVM-069 assembly drawing	14
9	TPS92682EVM-069 Top Layer and Top Overlay (Top View)	15
10	TPS92682EVM-069 inner-layer 1	15
11	TPS92682EVM-069 inner-layer 2	16
12	TPS92682EVM-069 bottom layer and bottom overlay (Bottom View)	16
13	Setup Screen 1	20
14	Setup Screen 2	21
15	Setup Screen 3	21
16	Setup Screen 4	22
17	Setup Screen 5	22
18	Setup Screen 6	23
19	Setup Screen 7	23
20	Setup Screen 8	24
21	Setup Screen 9	24
22	Setup Screen 10.....	25
23	Setup Screen 11.....	25
24	Setup Screen 12.....	26
25	Setup Screen 13.....	26
26	Setup Screen 14.....	27
27	Setup Screen 15.....	27
28	Setup Screen 16.....	27
29	Setup Screen 17.....	28
30	Setup Screen 18.....	28
31	Setup Screen 9	29
32	LaunchPad Connection for Programming.....	30
33	UniFlash Programming, Step 1	30
34	UniFlash Programming, Step 2.....	31
35	UniFlash Programming, Step 3.....	31
36	UniFlash Programming, Step 4.....	32
37	UniFlash Programming, Step 5.....	32
38	LaunchPad Connection for GUI Operation	33
39	LaunchPad Connection to TPS92682EVM-069	34
40	GUI Setup Screen 1	35
41	GUI Setup Screen 2	35
42	GUI Setup Screen 3	35
43	GUI, Main Window	36
44	SPI Command Window.....	37
45	SPI Command Window.....	38
46	Fault Status after Pushing the Read Faults Once	39
47	Fault Status after Pushing the Read Faults Twice.....	39

48	Enabling the EVM	39
----	------------------------	----

List of Tables

1	Connector Descriptions	8
2	Test Points	9
3	TPS92682EVM Performance Specifications	10
4	TPS92682EVM-069 Bill of Materials.....	17

General Texas Instruments High Voltage Evaluation (TI HV EMV) User Safety Guidelines



Always follow TI's set-up and application instructions, including use of all interface components within their recommended electrical rated voltage and power limits. Always use electrical safety precautions to help ensure your personal safety and those working around you. Contact TI's Product Information Center [http://ti.com/customer support](http://ti.com/customer_support) for further information.

Save all warnings and instructions for future reference.

WARNING

Failure to follow warnings and instructions may result in personal injury, property damage or death due to electrical shock and burn hazards.

The term TI HV EVM refers to an electronic device typically provided as an open framed, unenclosed printed circuit board assembly. It is *intended strictly for use in development laboratory environments, solely for qualified professional users having training, expertise and knowledge of electrical safety in development and application of high voltage electrical circuits. Any other use and/or application are strictly prohibited by Texas Instruments.* If you are not suitable qualified, you should immediately stop from further use of the HV EVM.

1. Work Area Safety:

- a. Keep work area clean and orderly.
- b. Qualified observer(s) must be present anytime circuits are energized.
- c. Effective barriers and signage must be present in the area where the TI HV EVM and its interface electronics are energized, indicating operation of accessible high voltages may be present, for the purpose of protecting inadvertent access.
- d. All interface circuits, power supplies, evaluation modules, instruments, meters, scopes, and other related apparatus used in a development environment exceeding 50Vrms/75VDC must be electrically located within a protected Emergency Power Off EPO protected power strip.
- e. Use stable and non-conductive work surface.
- f. Use adequately insulated clamps and wires to attach measurement probes and instruments. No freehand testing whenever possible.

2. Electrical Safety:

As a precautionary measure, it is always good engineering practice to assume that the entire EVM may have fully accessible and active high voltages.

- a. De-energize the TI HV EVM and all its inputs, outputs and electrical loads before performing any electrical or other diagnostic measurements. Revalidate that TI HV EVM power has been safely de-energized.
- b. With the EVM confirmed de-energized, proceed with required electrical circuit configurations, wiring, measurement equipment hook-ups and other application needs, while still assuming the EVM circuit and measuring instruments are electrically live.
- c. Once EVM readiness is complete, energize the EVM as intended.

WARNING

While the EVM is energized, never touch the EVM or its electrical circuits, as they could be at high voltages capable of causing electrical shock hazard.

3. Personal Safety

- a. Wear personal protective equipment e.g. latex gloves or safety glasses with side shields or protect EVM in an adequate lucent plastic box with interlocks from accidental touch.

Limitation for safe use:

EVMs are not to be used as all or part of a production unit.



User's Guide

SLUUBX9A–March 2019–Revised August 2019

TPS92682EVM-069 CV 2-Phase Boost Controller Evaluation Module

This user's guide describes the specifications, board connection description, characteristics, operation, and use of the TPS92682-Q1 constant-voltage 2-phase boost evaluation module (EVM). The TPS92682-Q1 device implements a fixed-frequency peak current mode control technique with programmable switching frequency, slope compensation, and soft-start. Additional features include wide input voltage range (4.5 V to 65 V), programmable spread spectrum frequency modulation, programmable fault handling, adjustable switching frequency, and adjustable output voltage setting. A complete schematic diagram, printed circuit board layouts, and bill of materials are included in this document.

1 Trademarks

SimpleLink, LaunchPad are trademarks of Texas Instruments.

2 Description

The TPS92682EVM-069 CV boost solution provides a 2-phase , constant voltage boost regulator which is configurable via SPI serial peripheral interface (SPI). It is designed to operate with an input voltage range of 6.5 V to 44 V. The EVM is specified for maximum output voltage of 60 V, maximum input current of $I_{IN} = 10$ A, and maximum output power of $P_{OUT} = 100$ W. The CV TPS92682EVM-069 provides high efficiency, SPI programmable fault handling, V_{OUT} setting, and spread-spectrum.

2.1 Typical Applications

This document outlines the operation and implementation of the TPS92682-Q1 as a 2-phase boost voltage regulator with the specifications listed in [Table 3](#). For applications with a different input voltage range or different output voltage range, refer to the TPS92682-Q1 data sheet ([SLUSCX8](#)). The MSP-EXP432E401Y SimpleLink™ Ethernet MSP432E401Y MCU LaunchPad™ Development Kit controls the TPS92682EVM-069 evaluation board. The MSP-EXP432E401Y is available on TI website. Alternatively, any SPI controller board can control the TPS92682EVM. After the LaunchPad board is obtained from the TI website, the board must be programmed according to the instructions provided in this design guide. The program instructions are provided in [Section 7](#).

2.2 Warnings

Observe the following precaution when using the TPS92682EVM-069 evaluation module.



Caution hot surface. Contact may cause burns. Do not touch.

2.3 Connector Description

Table 1 describes the connectors and Table 2 lists the test points on the EVM and how to properly connect, set up, and use the TPS92682EVM-069.

Figure 1 shows the connection diagram and the default jumper locations of the TPS92682EVM-069.

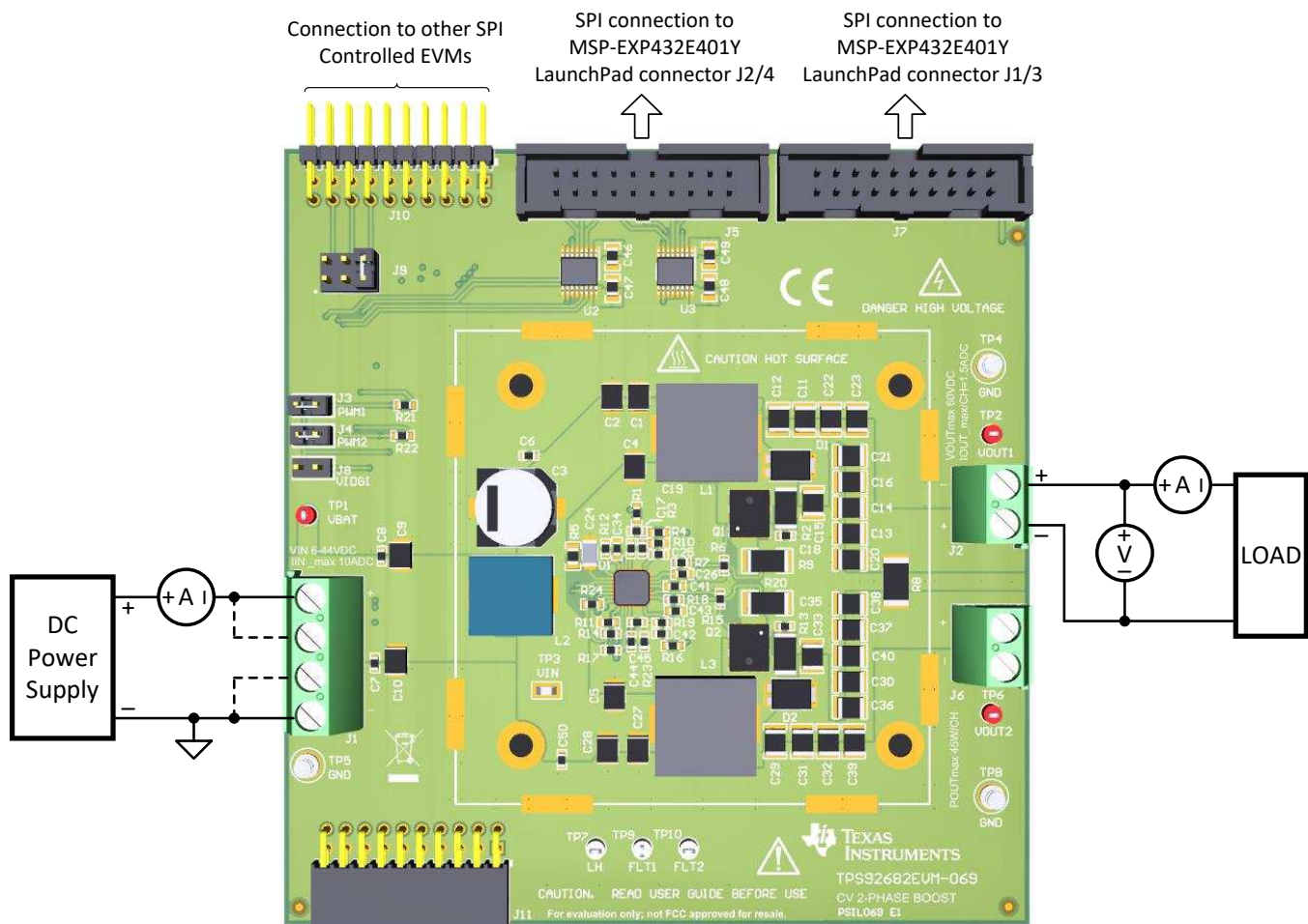

Figure 1. Connection diagram

Table 1. Connector Descriptions

Connector	Label	Description
J5	SPI control from the MSP-EXP432E401Y LaunchPad	J5 and J7 allow attachment of a header cable for SPI control of the TPS92682-Q1 to the TI SimpleLink™ Ethernet MSP-EXP432E401Y MCU LaunchPad™ Development Kit, part number MSP-EXP432E401Y
J7		
J10	SPI control signals to other SPI controlled EVM	J10 and J11 allow star connection of TPS92682EVM-069 boards to each other with one MSP-EXP432E401Y control board.
J11		

Table 1. Connector Descriptions (continued)

Connector	Label	Description
J1	VIN, GND	J1 connects the input power to the TPS92682EVM-069 board. The board silkscreen identifies VIN pins with "+" and the GND pins with "-" markings.
J2	VOUT1, VOUT2 and GND	J2 is connected to the channel-1 output and J6 is connected to the channel-2 output of the TPS92682-Q1 device. By default the board is configured as 2-phase. Therefore, VOUT1 and VOUT2 are shorted together with a zero-Ω resistor, R8.
J6		
J8	VDD jumper	J8 is a jumper provided to share VDD with other SPI controlled EVM, in case a digital supply is needed. For the operation of this EVM, leave this jumper open.
J3	PWM1 jumper	J3 and J4 are jumpers to allow for PWM signals to be applied to the two channels. When the jumpers are removed and the R21 and R22 zero-Ω resistors are installed, the PWM signals can be generated from the MSP-EXP432E401Y controller board. When the jumpers are populated (by default), the PWM1 and PWM2 pins of the TPS92682-Q1 are connected to VDD. The PWM signals can be used to disable the associated channels in CV mode.
J4	PWM2 jumper	
J9	SSN configuration jumper	J9 allows configuration of the SSN chip select line, when multiple chips on the same SPI bus are used. By default, evaluation module is configured to be connected to the SSN0 of the MSP-EXP432E401Y controller board.

Table 2. Test Points

Test Point	Description
Metal turrets	All metal turrets are grounds.
VBAT	The VBAT test point allows for voltage measurement of the external power supply applied to the evaluation board.
VIN	The VIN test point allows for voltage measurement of the power applied to the BOOST voltage regulator after the EMI filter.
LH	The LH test point allows for external application of voltage to the LH pin and place the TPS92682-Q1 in Limp Home mode
FLT1	The FLT1 test point can be used to monitor the fault occurrence of the channel-1. When a fault occurs, FLT1 voltage level goes low. Note that during power up, FLT1 is low (due to POR). The Fault pins can be reset by setting bit-7 of the EN register 0x00.
FLT2	The FLT2 test point can be used to monitor the fault occurrence of the channel-2. When a fault occurs, FLT2 voltage level goes low. Note that during power up, FLT2 is low (due to POR). The Fault pins can be reset by setting bit-7 of the EN register 0x00. The FLT2 test point can also be used for synchronizing of the TPS92682-Q1 with an external clock.
VOUT1	The VOUT1 test point allows for voltage measurement of the channel-1 output.
VOUT2	The VOUT2 test point allows for voltage measurement of the channel-2 output.

3 REACH Compliance

In compliance with the Article 33 provision of the EU REACH regulation we are notifying you that this EVM includes component(s) containing at least one substance of very high concern (SVHC) above 0.1%. These uses from Texas Instruments do not exceed 1 ton per year. The SVHC's are:

Component Manufacturer	Component part number	SVHC Substance	SVHC CAS (when available)
Phoenix Contact GmbH & Co. KG	1715721 and 1715747	Lead (Pb)	7439-92-1

4 Performance Specifications

Table 3 provides the EVM electrical performance specifications.

Table 3. TPS92682EVM Performance Specifications

Parameter	Description	Min	Typ	Max	Units
Input Characteristics					
Voltage, V_{IN}		6.5	14	28	V
Maximum Input Current, I_{IN}				10	A
Output Characteristics					
Output Voltage, V_{OUT}	Maximum voltage configured by the output voltage divider and programmable by the SPI	V_{IN}		61	V
Maximum Output Current, I_{OUT}	Total output current in 2-phase mode			3	A
Maximum Output Power, P_{OUT}	Total output power in 2-phase mode			90	W
Systems Characteristics					
Switching frequency	Switching Frequency (f_{SW}) Range	100		800	kHz
Peak efficiency				95	%
Operating temperature		-40	25	125	°C

5 Performance Data and Typical Characteristic Curves

Figure 2 illustrates the efficiency results for the TPS92682EVM-069 vs output power for different input voltage V_{IN} . It is important to note that the efficiency results include the power loss in the input EMI filter.

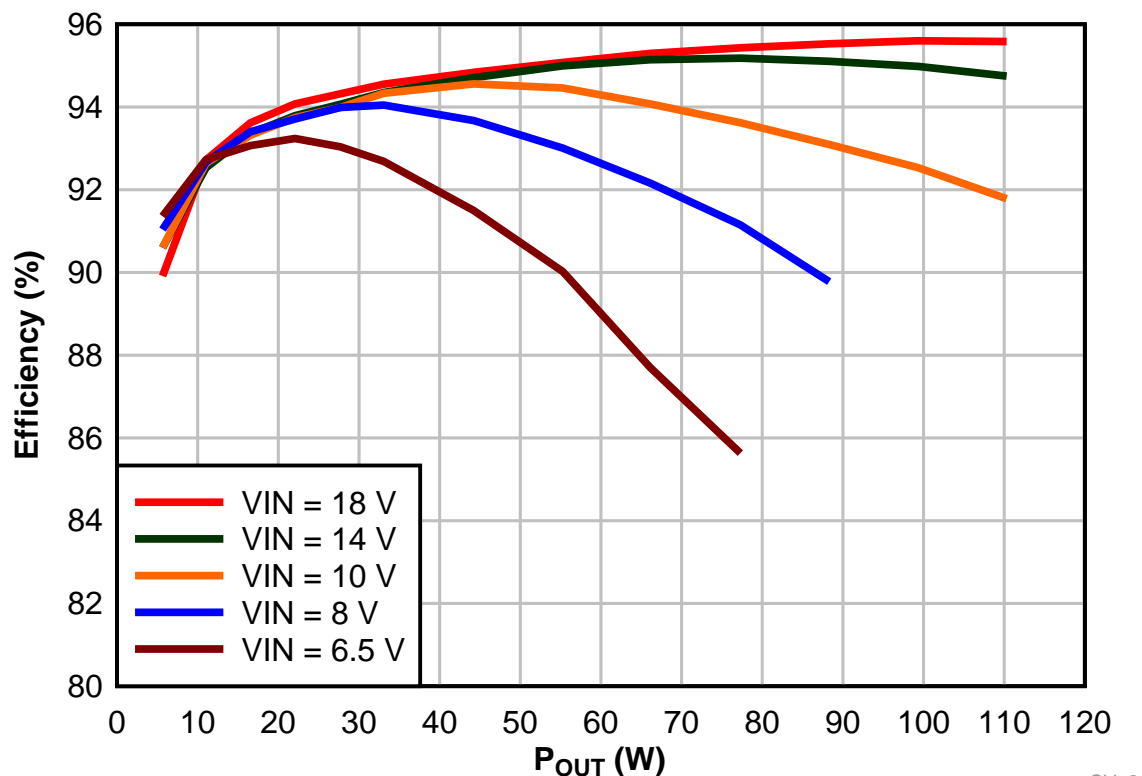
BOOST CV 2-Phase Efficiency vs P_{OUT} (W)

CV_2

 Conditions: V_{OUT} 55 V.

Figure 2. Efficiency vs Output Power

5.1 2-phase CV BOOST SW-Node Voltage Waveform

Figure 2 shows the switch node voltage waveforms of the Phase-1 (channel-1) and Phase-2 (channel-2) of the TPS92682EVM-069 2-phase CV BOOST, together with the output voltage (V_{OUT}) set to 50 V. The switch turn-on of the two phases are 180° phase shifted in order to reduce input current and output voltage ripple.

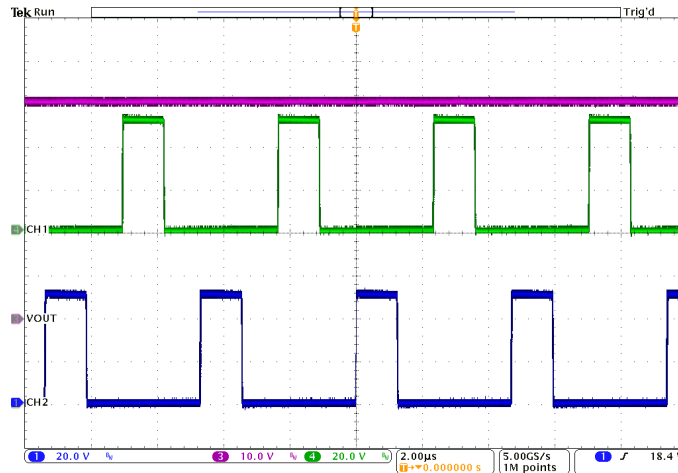

$V_{OUT} = 50\text{ V}$

Figure 3. CV boost 2-phase SW-node voltage

5.2 Startup Waveforms

Figure 4 and Figure 5 show the startup waveforms, V_{OUT} and compensator voltage of the TPS92682EVM-069 2-phase CV boost for two different soft-start register (0x06) settings.

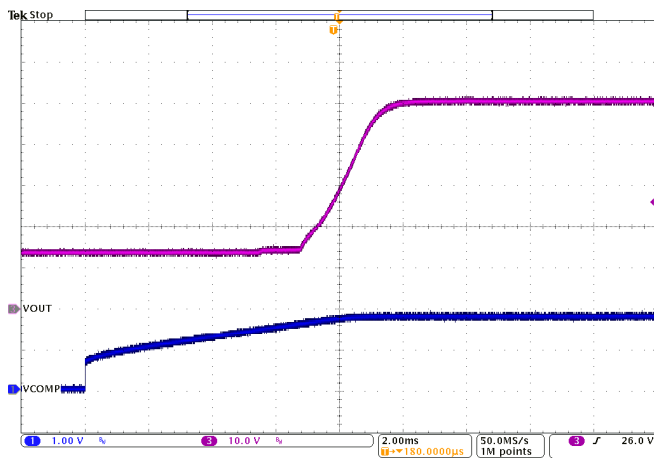

CHxSS3:0 = 7

Figure 4. Soft-start timing

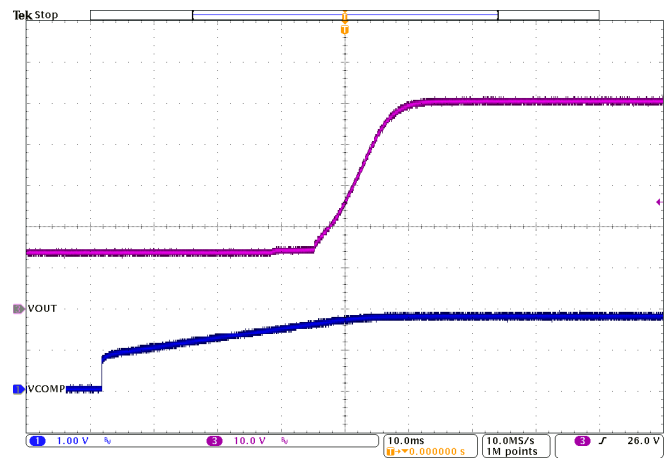

CHxSS3:0 = 31

Figure 5. Softstart waveforms for

5.3 Load Transient

Figure 6 shows the load transient on the output of the TPS92682EVM-069 2-phase CV boost. The output current is stepped up and down from 0.2 A to 2 A (P_{OUT} from 10 W to 100 W). The V_{OUT} waveform (in purple) shows the resulting undershoot and overshoot.

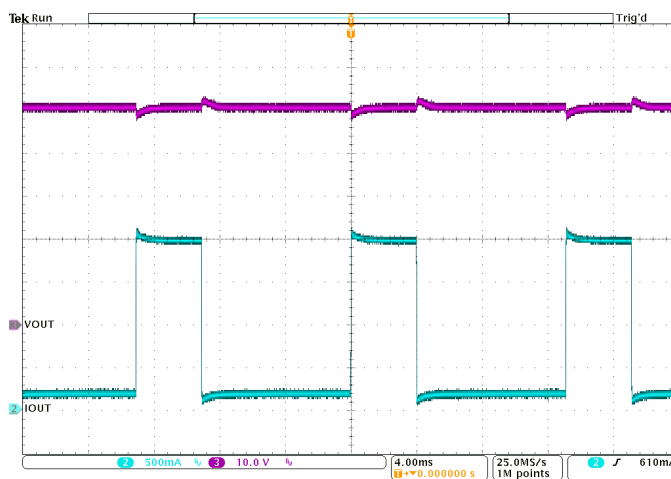

$V_{IN} = 14\text{ V}$, $V_{OUT} = 50\text{ V}$

Figure 6. CV 2-phase boost load transient

6 Schematic, PCB Layout, and Bill of Materials

This section contains TPS92682EVM-069 schematics, PCB layouts, and bill of materials (BOM).

6.1 Schematic

Figure 7 illustrates the TPS92682EVM-069 schematic.

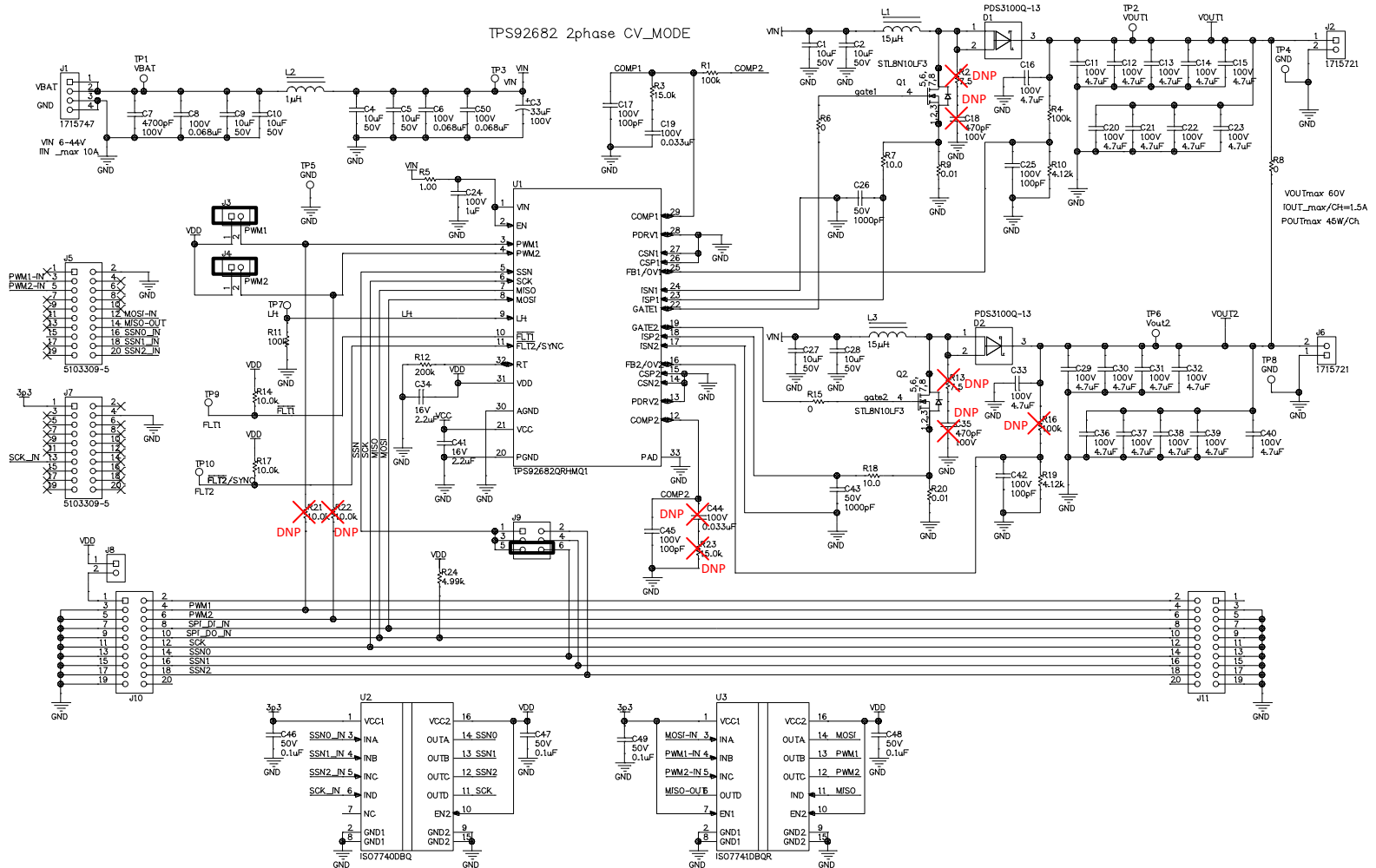

Figure 7. TPS92682EVM-069 Schematic

6.2 Layout

The TPS92682EVM-069 is a 4-layer board. [Figure 8](#), [Figure 9](#), [Figure 10](#), [Figure 11](#) and [Figure 12](#) illustrate the assembly, the top, the inner-layer1, the inner-layer2 and the bottom side of the TPS92682EVM-069 PCB layout. The Inner-layer 1 is a ground plane and there is no routing on this layer.

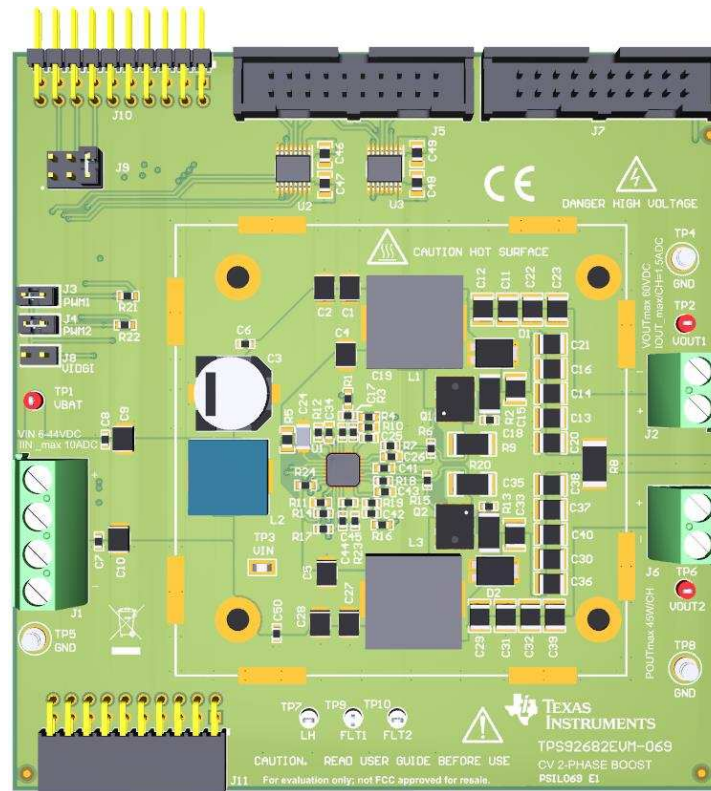

Figure 8. TPS92682EVM-069 assembly drawing

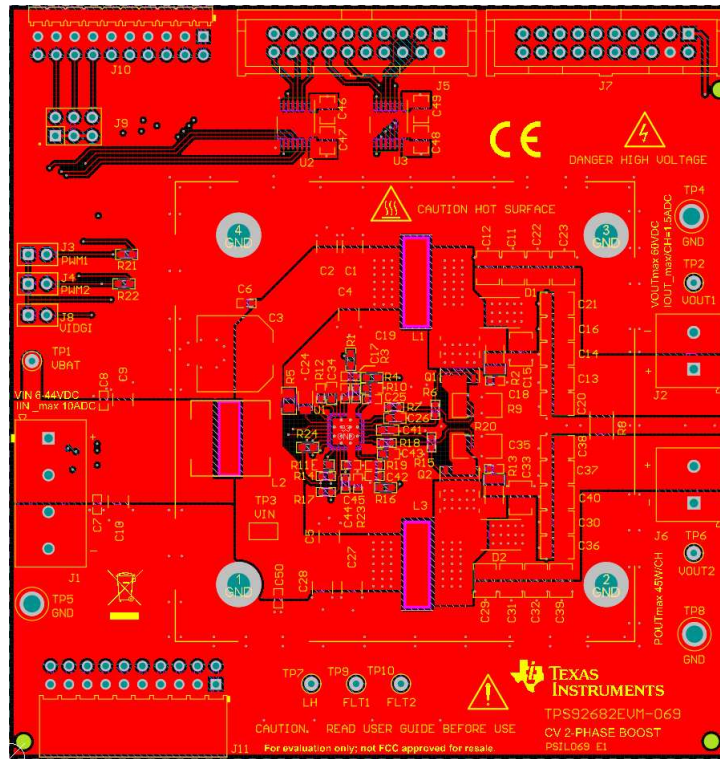

Figure 9. TPS92682EVM-069 Top Layer and Top Overlay (Top View)

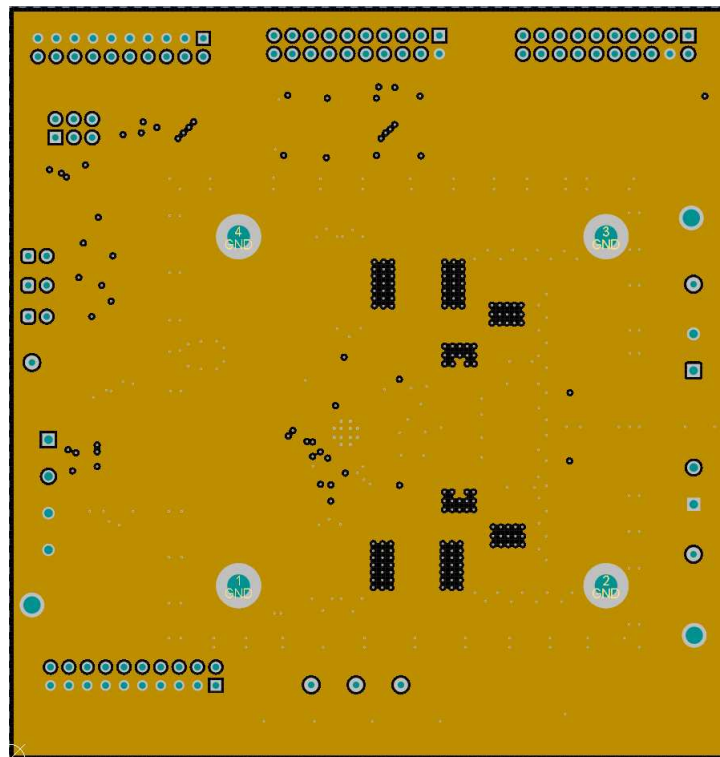

Figure 10. TPS92682EVM-069 inner-layer 1

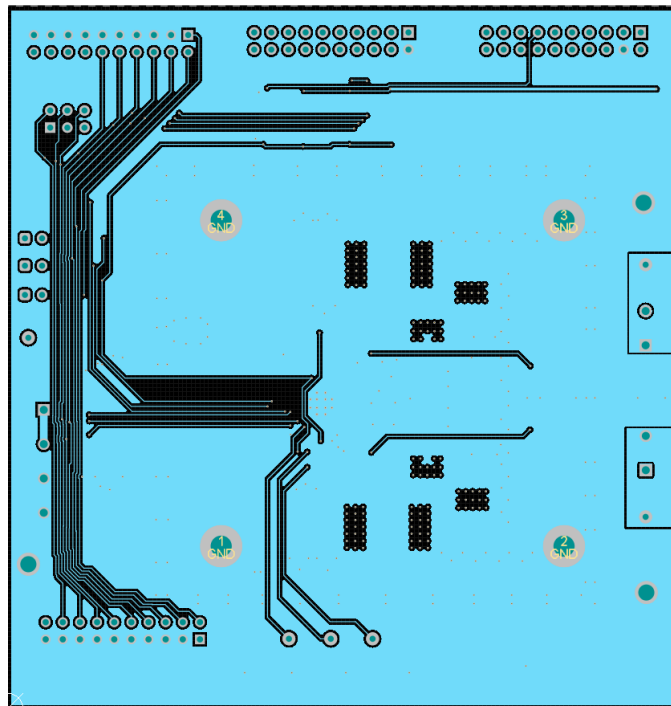

Figure 11. TPS92682EVM-069 inner-layer 2

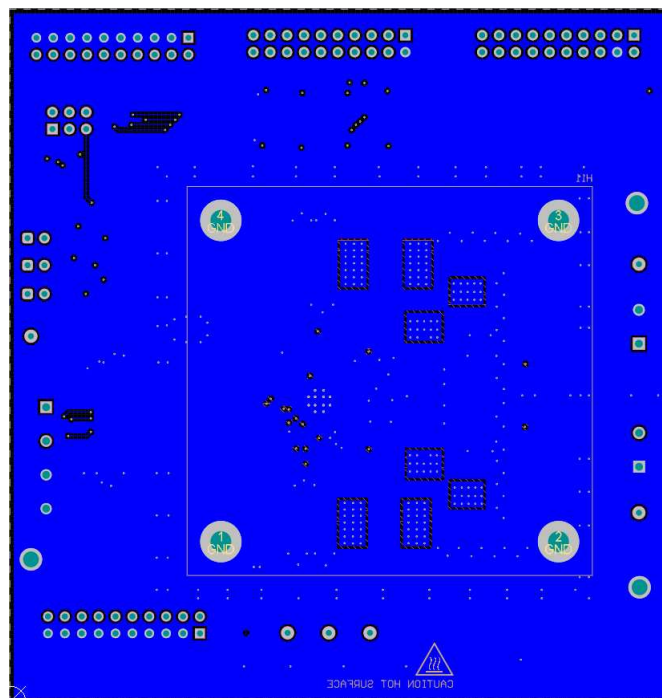

Figure 12. TPS92682EVM-069 bottom layer and bottom overlay (Bottom View)

6.3 Bill of Materials

Table 4 lists the TPS92682EVM-069 bill of materials.

Table 4. TPS92682EVM-069 Bill of Materials

Designator	Qty	Value	Description	Package	Part Number	Manufacturer
C1, C2, C4, C5, C9, C10, C27, C28	8	10 μ F	CAP, CERM, 10 μ F, 50 V, \pm 10%, X7S, AEC-Q200 Grade 1	1210	CGA6P3X7S1H106K250AB	TDK
C3	1	33 μ F	CAP, AL, 33 μ F, 100 V, \pm 20%, AEC-Q200 Grade 2, SMD	D10xL10mm	MAL215097904E3	Vishay
C6, C8, C50	3	0.068 μ F	CAP, CERM, 0.068 μ F, 100 V, \pm 10%, X7S, AEC-Q200 Grade 1	0603	CGA3E3X7S2A683K080AB	TDK
C7	1	4700 pF	CAP, CERM, 4700 pF, 100 V, \pm 10%, X7R, AEC-Q200 Grade 1	0603	CGA3E2X7R2A472K080AA	TDK
C11, C12, C13, C14, C15, C16, C20, C21, C22, C23, C29, C30, C31, C32, C33, C36, C37, C38, C39, C40	20	4.7 μ F	CAP, CERM, 4.7 μ F, 100 V, \pm 10%, X7S, AEC-Q200 Grade 1	1210	CGA6M3X7S2A475K200AB	TDK
C17, C25, C42, C45	4	100 pF	CAP, CERM, 100 pF, 100 V, \pm 5%, C0G/NP0, AEC-Q200 Grade 1	0603	GCM1885C2A101JA16D	MuRata
C19	1	0.033 μ F	CAP, CERM, 0.033 μ F, 100 V, \pm 10%, X7S, AEC-Q200 Grade 1	0603	CGA3E3X7S2A333K080AB	TDK
C24	1	1 μ F	CAP, CERM, 1 μ F, 100 V, \pm 10%, X7R	1206	GCM31CR72A105KA03	MuRata
C26, C43	2	1000 pF	CAP, CERM, 1000 pF, 50 V, \pm 5%, X7R, AEC-Q200 Grade 1	0603	C0603C102J5RACAUTO	Kemet
C34, C41	2	2.2 μ F	CAP, CERM, 2.2 μ F, 16 V, \pm 20%, X7S, AEC-Q200 Grade 1	0603	CGA3E1X7S1C225M080AC	TDK
C46, C47, C48, C49	4	0.1 μ F	CAP, CERM, 0.1 μ F, 50 V, \pm 10%, X7R	0805	C0805C104K5RACTU	Kemet
D1, D2	2	100 V	Diode, Schottky, 100 V, 3 A, AEC-Q101	POWERDI5	PDS3100Q-13	Diodes Inc
H1, H2, H5, H6	4		MACHINE SCREW PAN PHILLIPS 4-40		PMS 440 0038 PH	B&F Fastener Supply
H3, H4, H7, H8	4				HNSS440	B&F Fastener Supply
H9	1		Sil-Pad K-10 high performance insulator		SPK10-0.006-AC-1212-NA	BERGQUIST
H10, H12, H13, H14, H15, H16, H17, H18	8		RFI SHIELD CLIP TIN SMD		S2711-46R	Harwin
H11	1		Heatsink DC/DC half brick vert		518-95AB	Wakefield Solutions
J1	1		Terminal Block, 5.08mm, 4x1, TH	4POS Terminal Block	1715747	Phoenix Contact
J2, J6	2		Terminal Block, 5.08 mm, 2x1, TH	2POS Terminal Block	1715721	Phoenix Contact

Table 4. TPS92682EVM-069 Bill of Materials (continued)

Designator	Qty	Value	Description	Package	Part Number	Manufacturer
J3, J4, J8	3		Header, 100 mil, 2x1, Gold, TH	2x1 Header	TSW-102-07-G-S	Samtec
J1, J4	2		Header (shrouded), 100 mil, 10x2, Gold, TH	10x2 Header	5103309-5	TE Connectivity
J9	1		Header, 100 mil, 3x2, Gold, TH	3x2 Header	TSW-103-07-G-D	Samtec
J10	1		Header, 2.54 mm, 10x2, Tin, R/A, TH	10 x 2 Header	TSW-110-08-x-D-RA	Samtec
J11	1		Receptacle, 2.54mm, 10x2, Gold, R/A, TH	10 x 2 Header	SSW-110-02-G-D-RA	Samtec
L1, L3	2	15 μ H	Inductor, Shielded, 15 μ H, 8.5 A, 0.02299 Ω , AEC-Q200 Grade 0, SMD	13x12.5mm	SPM12565VT-150M-D	TDK
L5	1	1 μ H	Inductor, Shielded, 1 μ H, 22.5 A, 0.0026 Ω , AEC-Q200 Grade 0, SMD	10.5x10mm	SPM10065VT-1R0M-D	TDK
Q1, Q2	2	100 V	MOSFET, N-CH, 100 V, 20 A, AEC-Q101, 8-PowerVDFN	PowerFLAT5x6_R	STL8N10LF3	STMicroelectronics
R1, R6, R15	3	0	RES, 0, 1%, 0.1 W, AEC-Q200 Grade 0	0603	RMCF0603ZT0R00	Stackpole Electronics
R3	1	15.0 k Ω	RES, 15.0 k, 1%, 0.1 W	0603	RC0603FR-0715KL	Yageo
R4, R11	2	100 k Ω	RES, 100 k, 1%, 0.1 W, AEC-Q200 Grade 0	0603	RC0603FR-07100KL	Yageo
R5	1	1.00 Ω	RES, 1.00, 1%, 0.125 W, AEC-Q200 Grade 0	0805	CRCW08051R00FKEA	Vishay-Dale
R7, R18	2	10.0 Ω	RES, 10.0, 1%, 0.1 W, AEC-Q200 Grade 0	0603	CRCW060310R0FKEA	Vishay-Dale
R8	1	0 Ω	RES, 0, 0.05%, 2 W, AEC-Q200 Grade 0	2512	HCJ2512ZT0R00	Stackpole Electronics
R9, R20	2	0.01 Ω	RES, 0.01, 1%, 1 W	2010	PMR50HZPFU10L0	Rohm
R10, R19	2	4.12 k Ω	RES, 4.12 k, 1%, 0.1 W, AEC-Q200 Grade 0	0603	CRCW06034K12FKEA	Vishay-Dale
R12	1	200 k Ω	RES, 200 k, 1%, 0.1 W, AEC-Q200 Grade 0	0603	CRCW0603200KFKEA	Vishay-Dale
R14, R17, R21, R22	4	10.0 k Ω	RES, 10.0 k, 1%, 0.1 W, AEC-Q200 Grade 0	0603	CRCW060310K0FKEA	Vishay-Dale
R24	1	4.99 k Ω	RES, 4.99 k, 0.1%, 0.1 W	0603	RT0603BRD074K99L	Yageo
SH-J1, SH-J2, SH-J3, SH-J4, SH-J5, SH-J6, SH-J7	7		Shunt, 2.54 mm, Gold, Black	2x1, 2.54mm	60900213421	Würth Elektronik
TP1, TP2, TP6	3		Test Point, Miniature, Red, TH	TH	5000	keystone
TP3	1		Test Point, Miniature, SMT	SMT	5015	keystone
TP4, TP5, TP8	3		Terminal, Turret, TH, Double	Turret	1502-2	keystone
TP7, TP9, TP10	3		Test Point, Miniature, White, TH	TH	5002	keystone
U1	1		Dual Channel Constant Voltage and Constant Current Controller with SPI Interface, RHM0032A (VQFNP-32)	RHM0032A	TPS92682QRHMQ1	Texas Instruments
U2	1		High-Speed, Low-Power, Robust EMC Quad-Channel Digital Isolator, DBQ0016A (SSOP-16)	DBQ0016A	ISO7740DBQ	Texas Instruments

Table 4. TPS92682EVM-069 Bill of Materials (continued)

Designator	Qty	Value	Description	Package	Part Number	Manufacturer
U3	1		High Speed, Robust EMC Quad-Channel Digital Isolators, DBQ0016A (SSOP-16)	DBQ0016A	ISO7741DBQR	Texas Instruments

7 Software

This section describes the installation of the GUI software, the necessary drivers to operate the TPS92682EVM-069.

7.1 Demonstration Kit Software Installation for MSP-EXP432E401Y LaunchPad Board

7.1.1 Installation overview

This is a summary of the installation steps. To see step-by step instructions with screen shots, see [Section 7.1.2](#).

1. Click on *TPS92682 LaunchPad Evaluation Software Installer.exe*,
2. Right click, and choose **Run As Administrator**
3. Click **yes** when *Windows Account Control* asks to allow the program to make changes to the computer
4. Click **I Agree** to the installation license terms and install in the recommended location

Installation will take a few minutes, as it may need to install Microsoft .NET Framework. If the installer asks if you wish to reboot after installing Microsoft .NET, you must click **Restart Later** and allow the driver installation to complete.

After running the *TPS92682 LaunchPad Evaluation Software Installer.exe*, the evaluation software window appears as shown in [Figure 13](#).

7.1.2 Step-by-step installation instructions

This section shows the detailed installation instructions with screen shots.

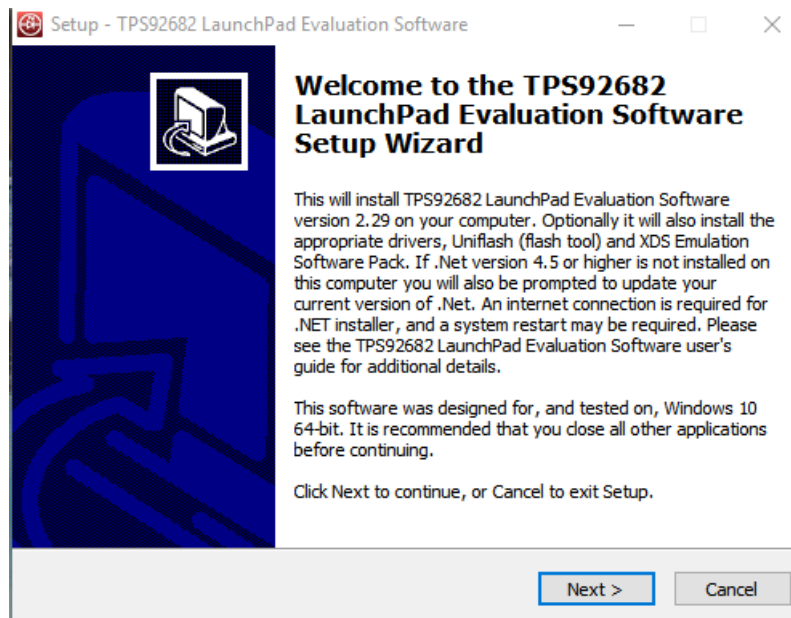

Figure 13. Setup Screen 1

Click **Next >** to install.

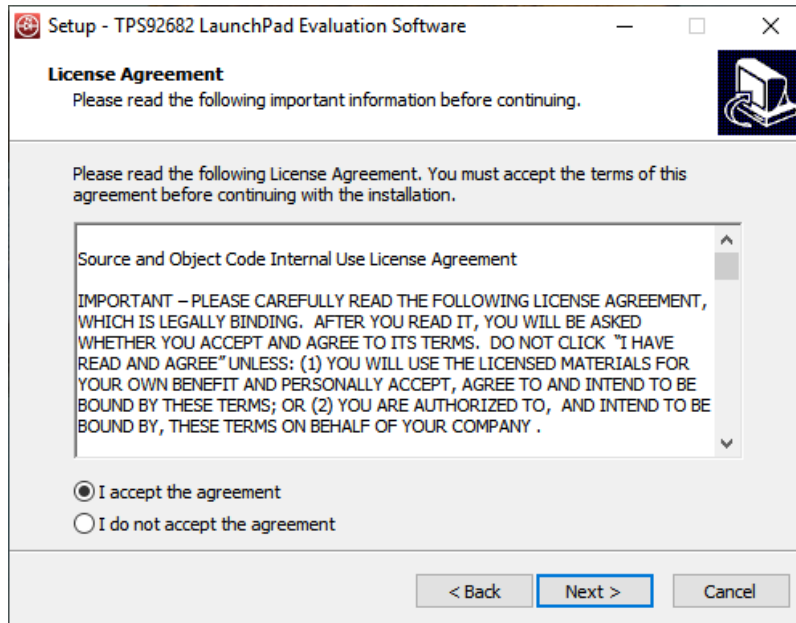

Figure 14. Setup Screen 2

Click **Next >** to accept the License Agreement.

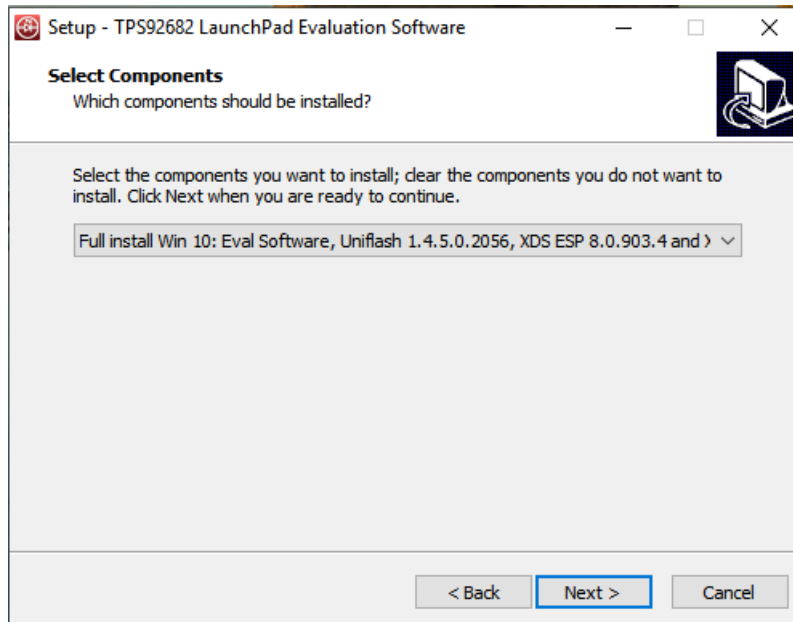

Figure 15. Setup Screen 3

Select **Full Install** and click **Next >** to install the evaluation software, the UniFlash, and the required XDS drivers. Full installation for both Windows 10 and 7 are provided.

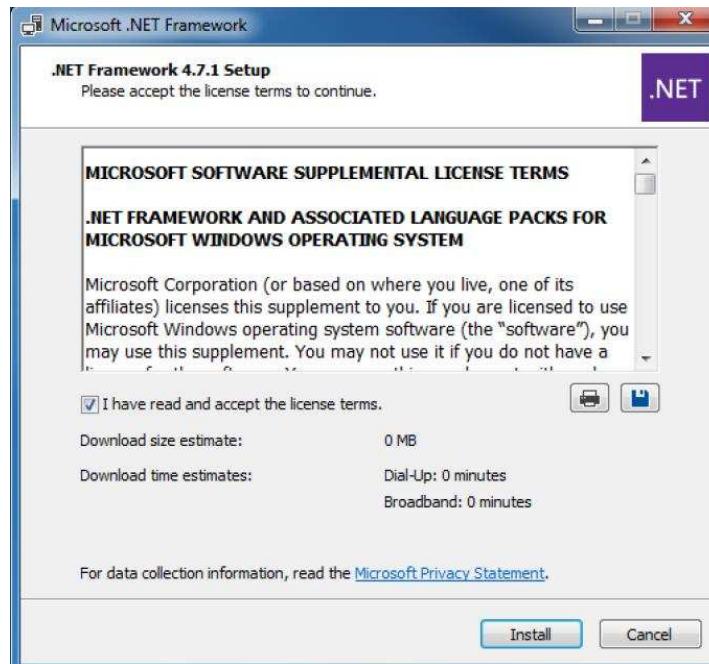

Figure 16. Setup Screen 4

If .NET Framework 4.5 or higher does not exist on the computer, the .NET Framework installation begins. Installation of .NET Framework will take several minutes. If .NET Framework 4.5 or higher exists on the computer, the installation jumps to the XDS driver installation.

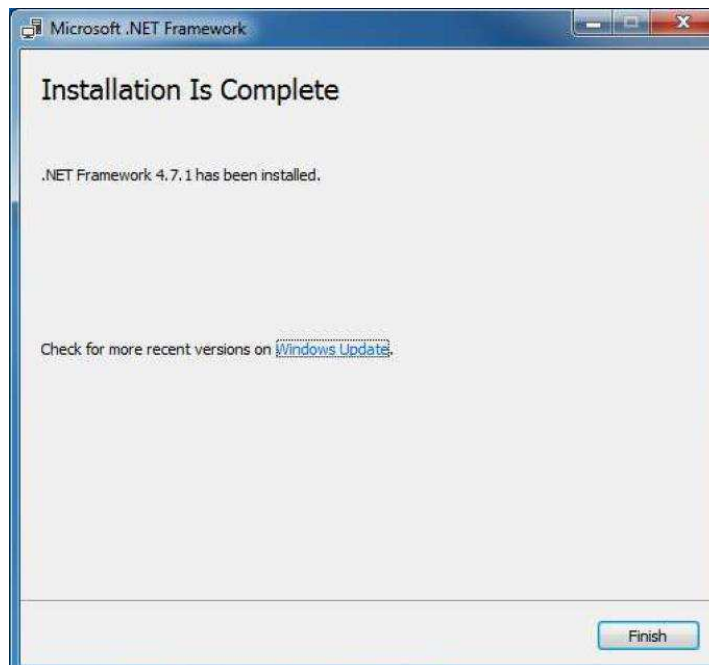

Figure 17. Setup Screen 5

A window appears indicating the completion of the .NET Framework installation.

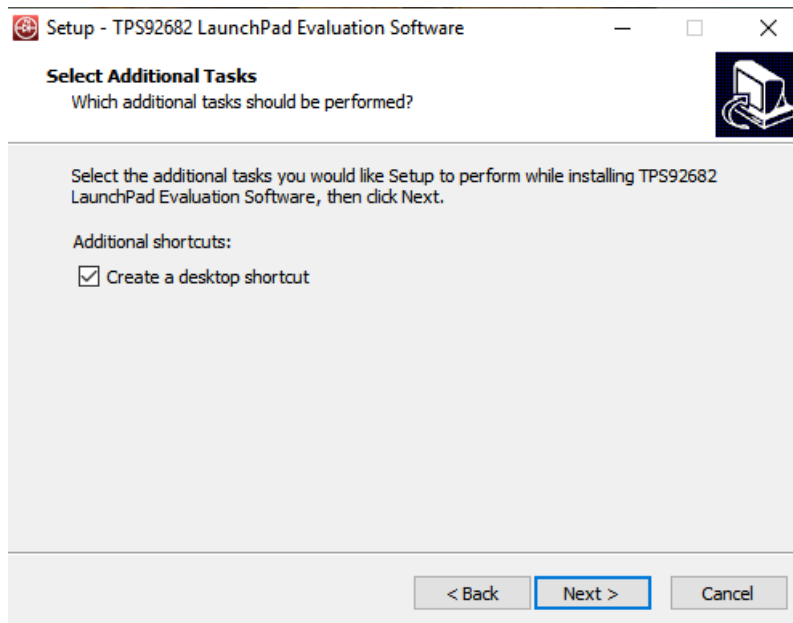

Figure 18. Setup Screen 6

Click next to proceed.

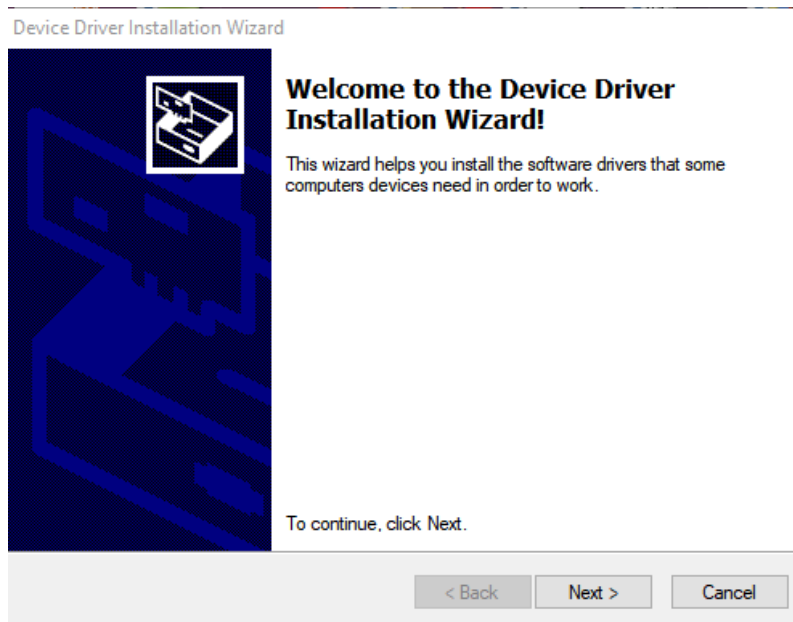

Figure 19. Setup Screen 7

Click the **Next >** button to install the XDS driver.

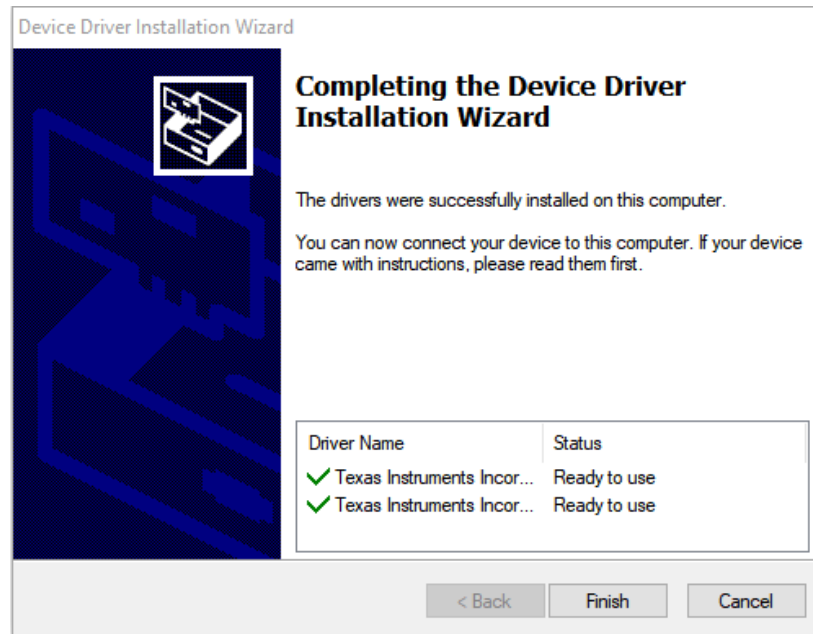

Figure 20. Setup Screen 8

The completion of the XDS driver installation is shown in [Figure 20](#).

The TI-Emulators installation starts at this point. This will install the necessary drivers for running the application. In the next few steps as shown in [Figure 21](#), [Figure 22](#) and [Figure 23](#) click **Next >** to perform the installation.

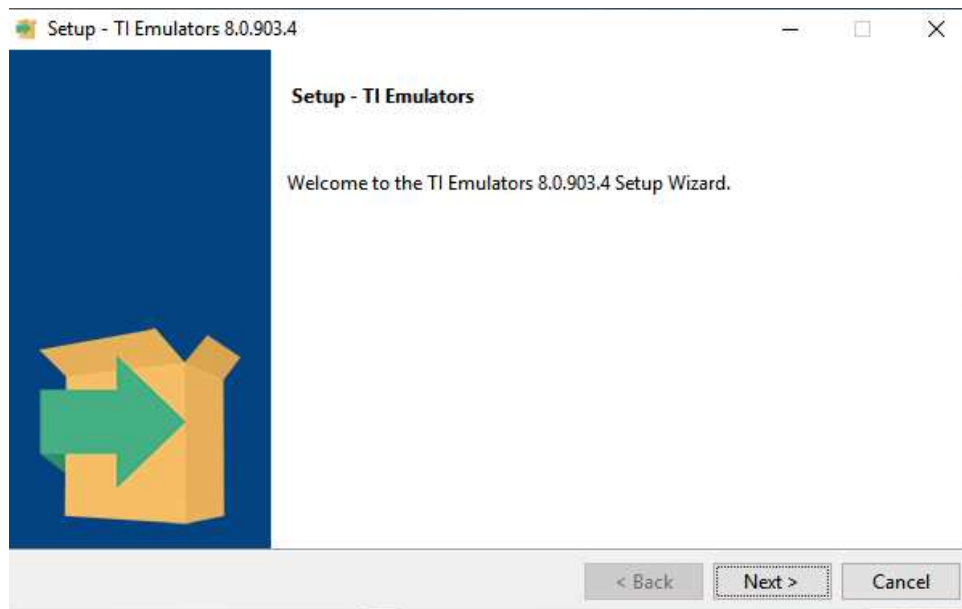

Figure 21. Setup Screen 9

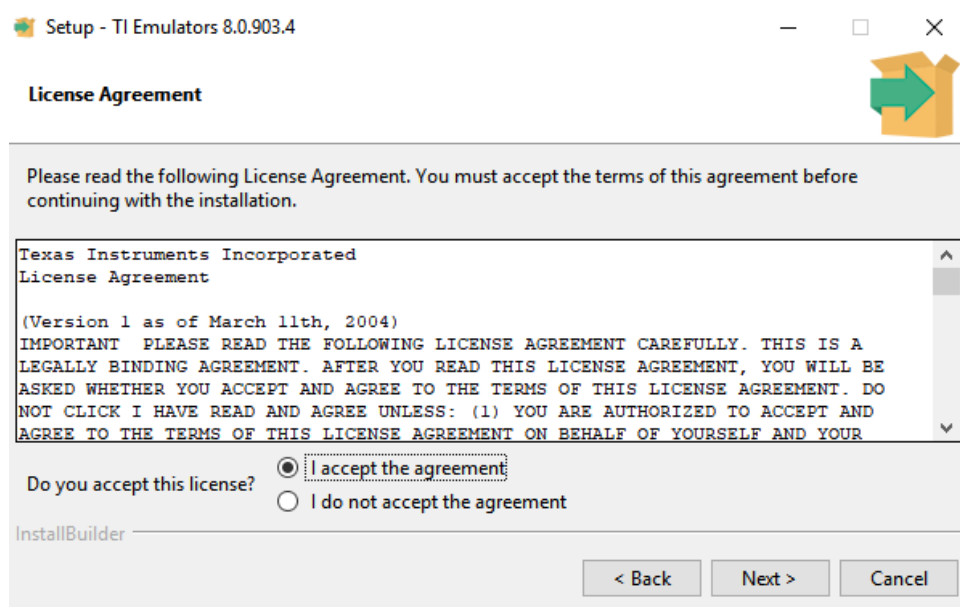

Figure 22. Setup Screen 10

Accept the license agreement in [Figure 22](#).

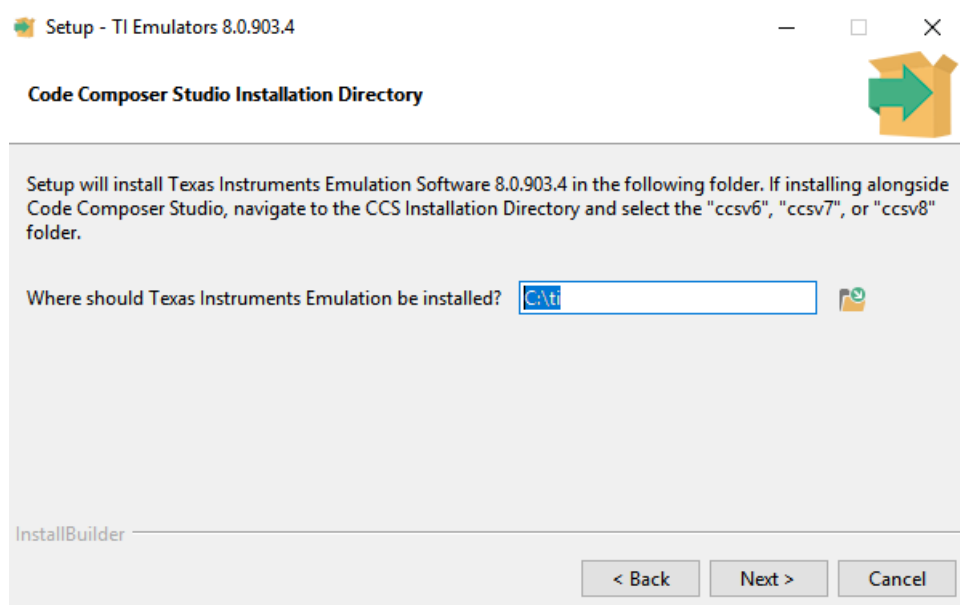

Figure 23. Setup Screen 11

In the next few windows click **Next >**, and if prompted by Windows Security about software installation as shown in [Figure 24](#), select **Install**.

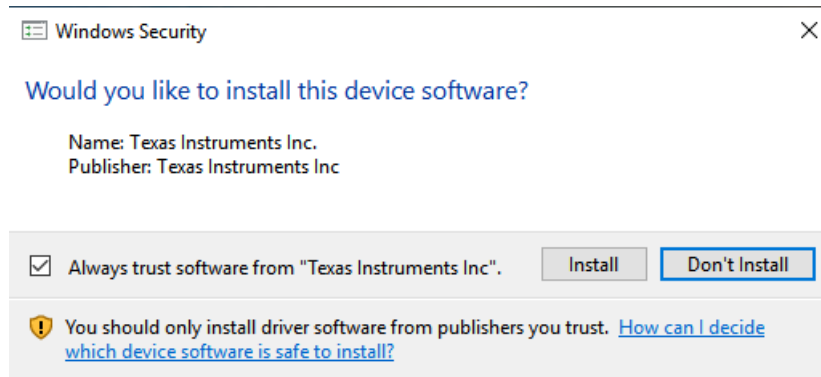

Figure 24. Setup Screen 12

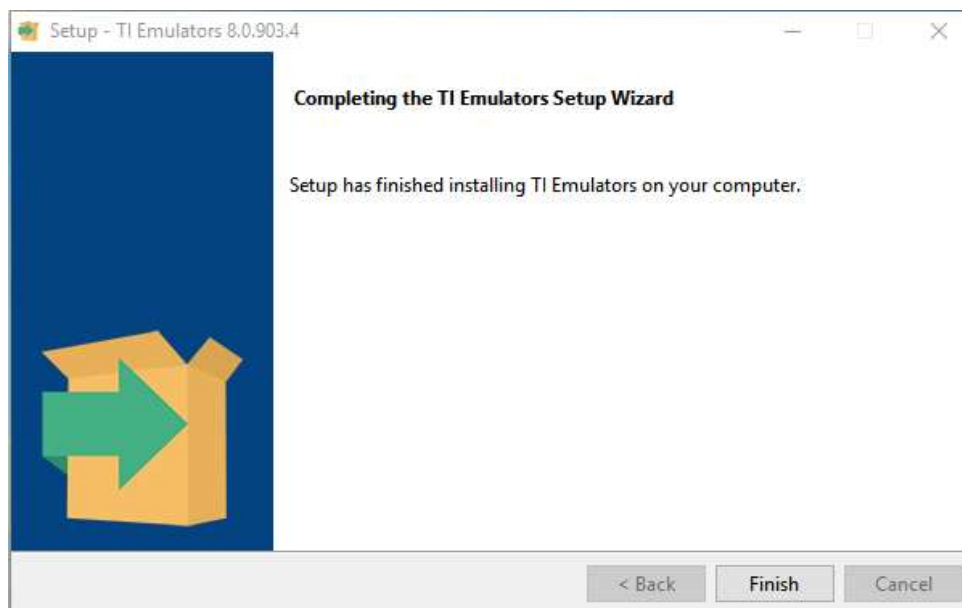

Figure 25. Setup Screen 13

The screen showing the completion of the TI Emulators installation is shown in [Figure 25](#). Click on **Finish** to move to the next step.

The UniFlash installation starts at this point. UniFlash is required to program the LaunchPad. In the next few steps as shown in [Figure 26](#), [Figure 27](#) and [Figure 28](#) click **Next >** to proceed and start the installation.

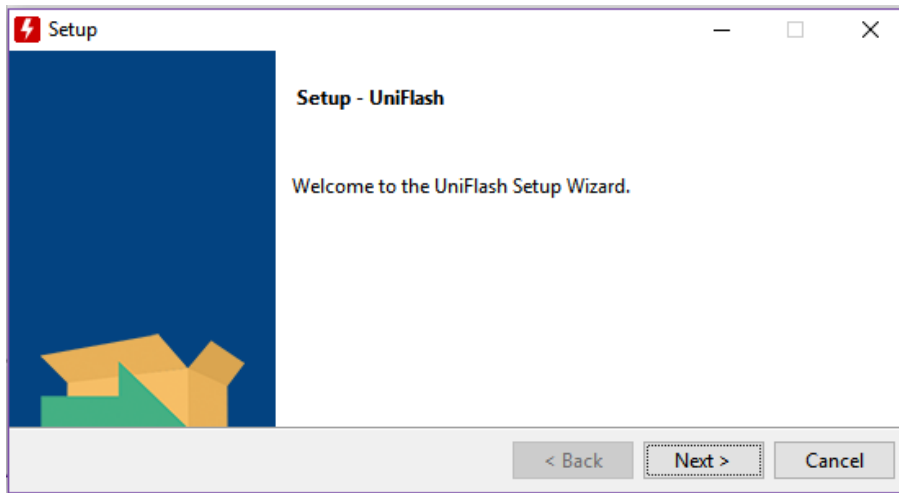

Figure 26. Setup Screen 14

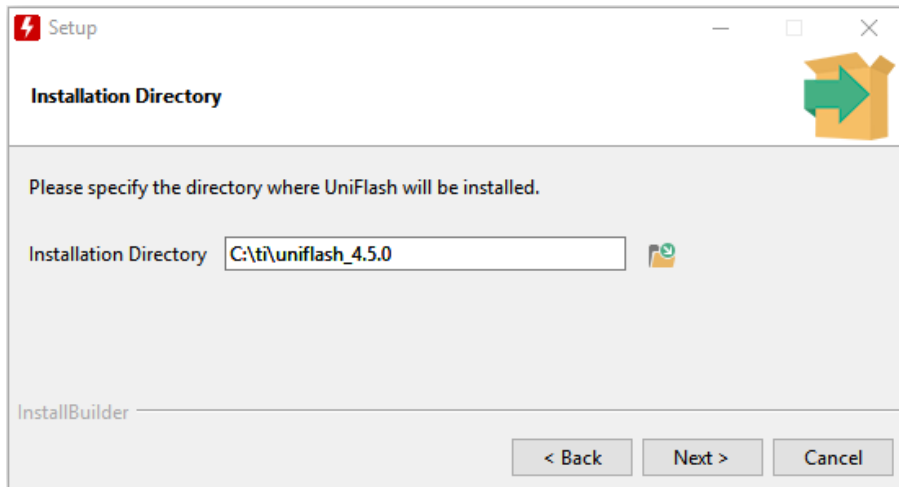

Figure 27. Setup Screen 15

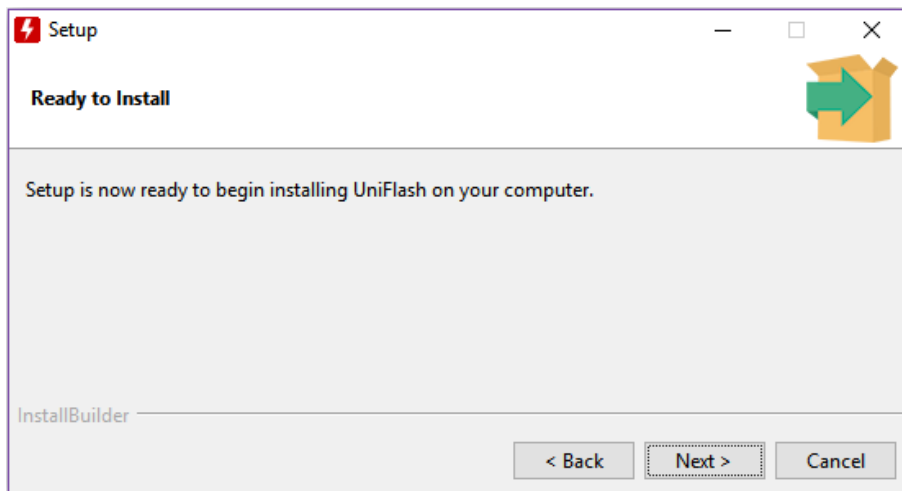

Figure 28. Setup Screen 16

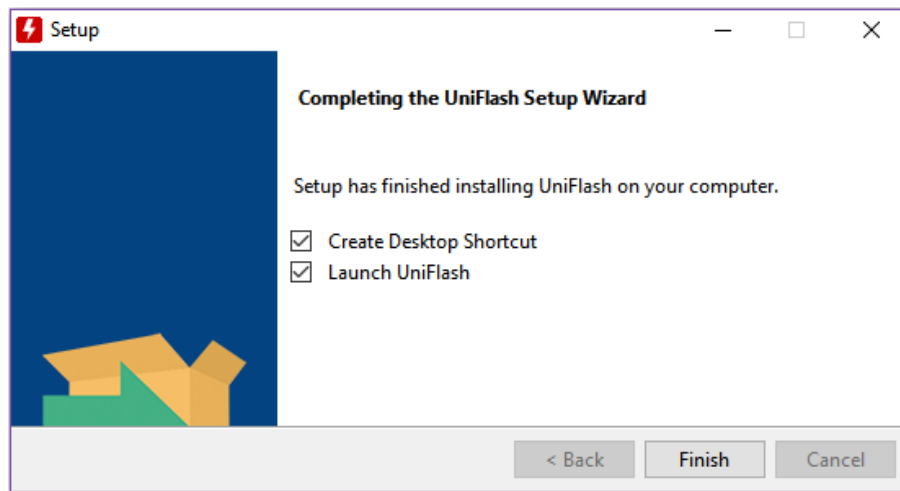

Figure 29. Setup Screen 17

When UniFlash installation is complete, click **Finish** to launch the UniFlash and program the LaunchPad.

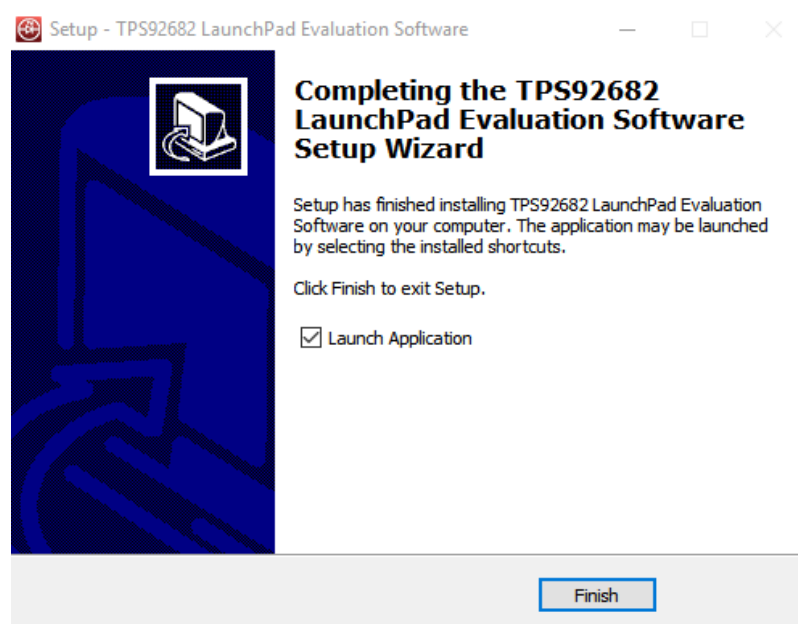

Figure 30. Setup Screen 18

Figure 30 shows the completion of the TPS92682-Q1 Evaluation Software . Un-check the **Launch Application** and click **Finish**.

7.2 Installation Error Recovery

If the screen shown in **Figure 31** appears, follow the steps below to install an unsigned driver one time.

1. Click **Start** and select **Settings**.
2. Click **Update and Security**.
3. Click **Recovery**.
4. Click **Restart Now** under **Advanced Startup**.
5. Click **Troubleshoot**.
6. Select **Advanced Options**.

7. Select **Startup Settings**.
8. Click **Restart**.
9. On the **Startup Settings** screen, press F7 during reboot to disable driver signature enforcement. The host computer restarts.
10. Repeat the entire reinstallation process.
11. A message appears informing that installing .NET failed. Close that window and continue.
12. Double-click **Install unsigned drivers**.

After restarting a second time, the host computer resets. The reset requires all drivers to be digitally signed the next time a default installation executes, unless these steps are repeated.



Figure 31. Setup Screen 9

7.3 Programming the MSP-EXP432E401Y LaunchPad Board

Use UniFlash to program the LaunchPad board before starting the GUI. Connect the included Micro-USB cable to the USB port of the PC and the LaunchPad as shown in [Figure 32](#). Connect a jumper between pin 3 and pin 4 of the connector JP1 as shown in [Figure 32](#).

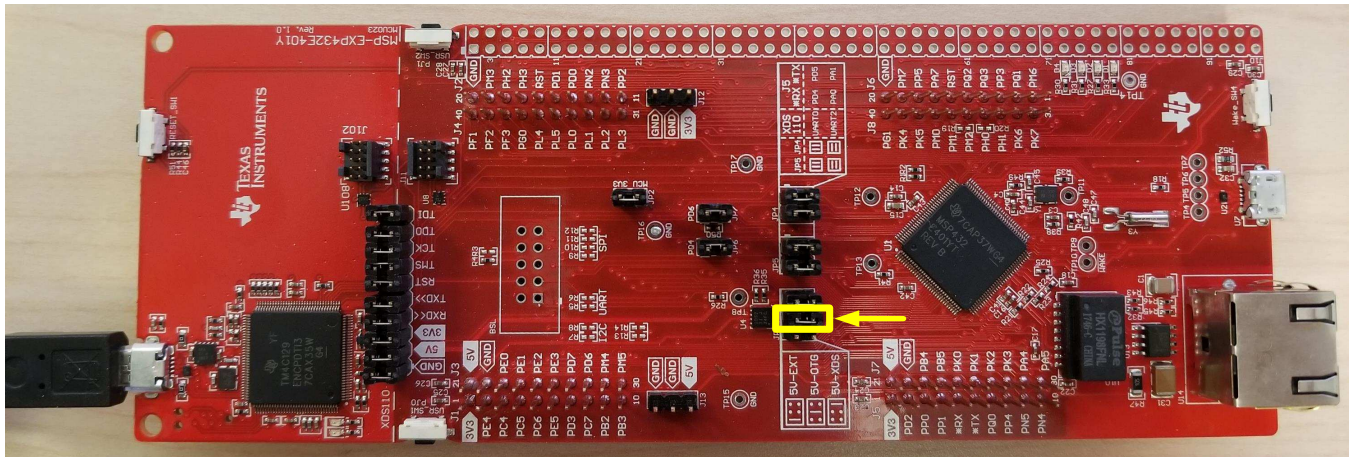

Figure 32. LaunchPad Connection for Programming

The installed UniFlash program should have been already opened at the end of the software setup shown in Figure 29. If the UniFlash program is not open, launch the program. The window in Figure 33 will be opened.

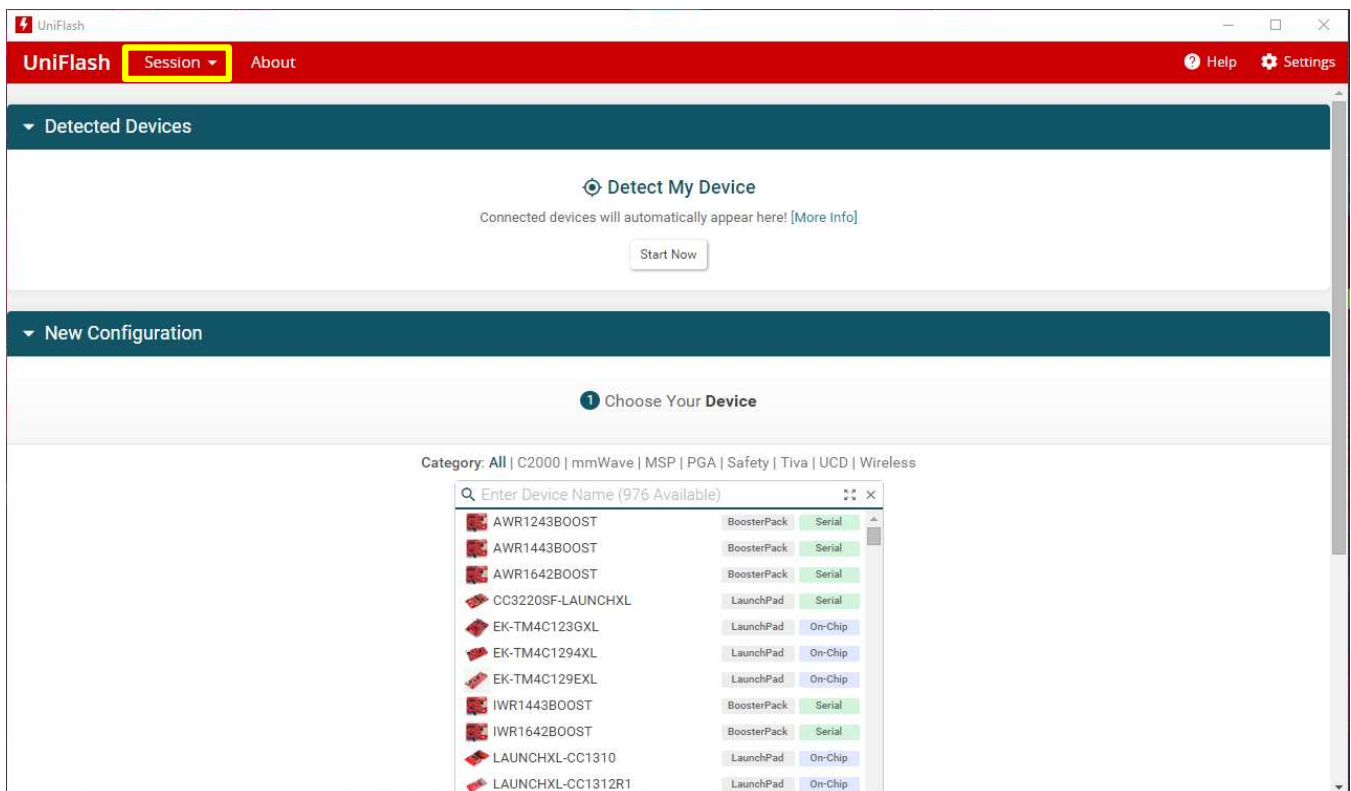

Figure 33. UniFlash Programming, Step 1

1. Click on **Session** as shown in Figure 33
2. Select **Load Session**

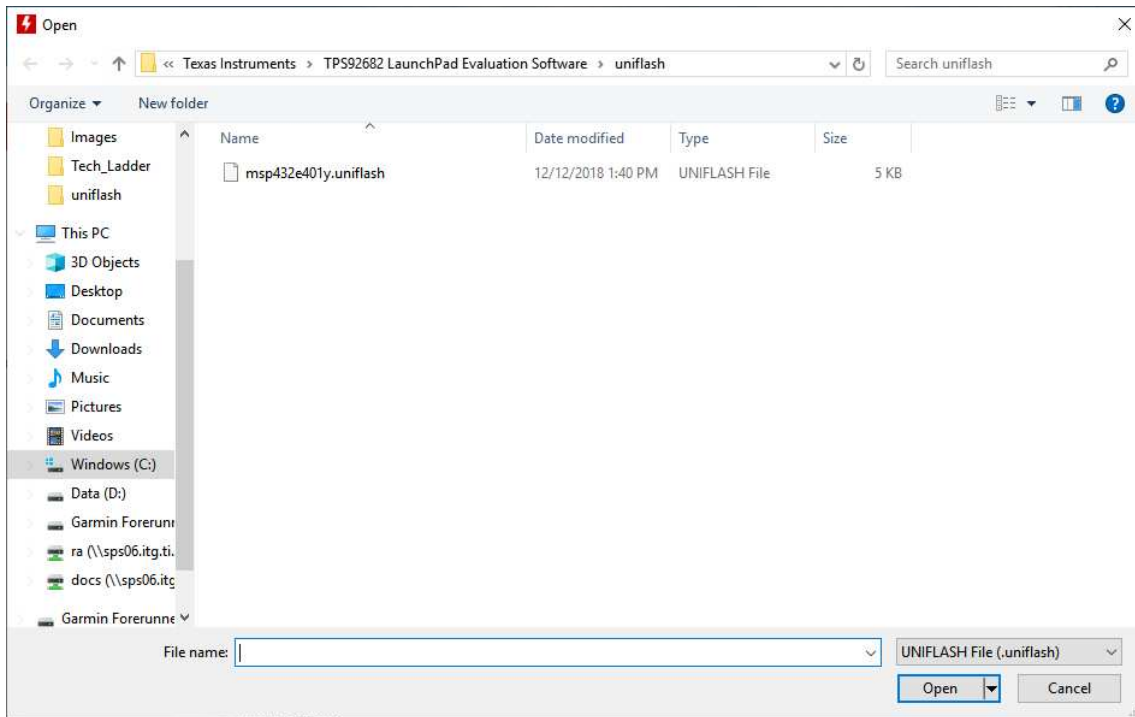

Figure 34. UniFlash Programming, Step 2

3. Navigate to "*:\Texas Instruments\TPS92682 LaunchPad Evaluation Software\uniflash*", as shown in [Figure 34](#),
4. Select the file **msp432e401y.uniflash**.

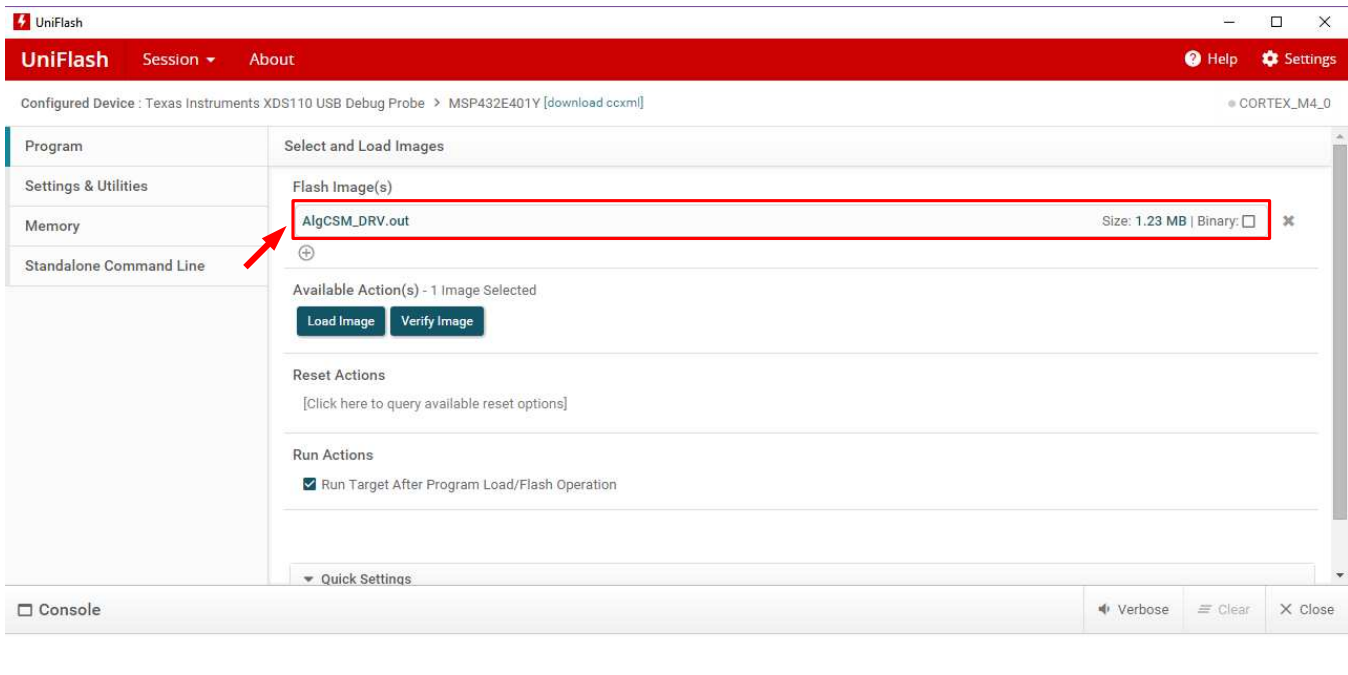

Figure 35. UniFlash Programming, Step 3

5. Click on the Flash Image file shown as the red box in [Figure 35](#).
6. Navigate to "*:\Texas Instruments\TPS92682 LaunchPad Evaluation Software\uniflash*"

7. Select the **AlgCSM_DRV.out** file as shown in [Figure 36](#)

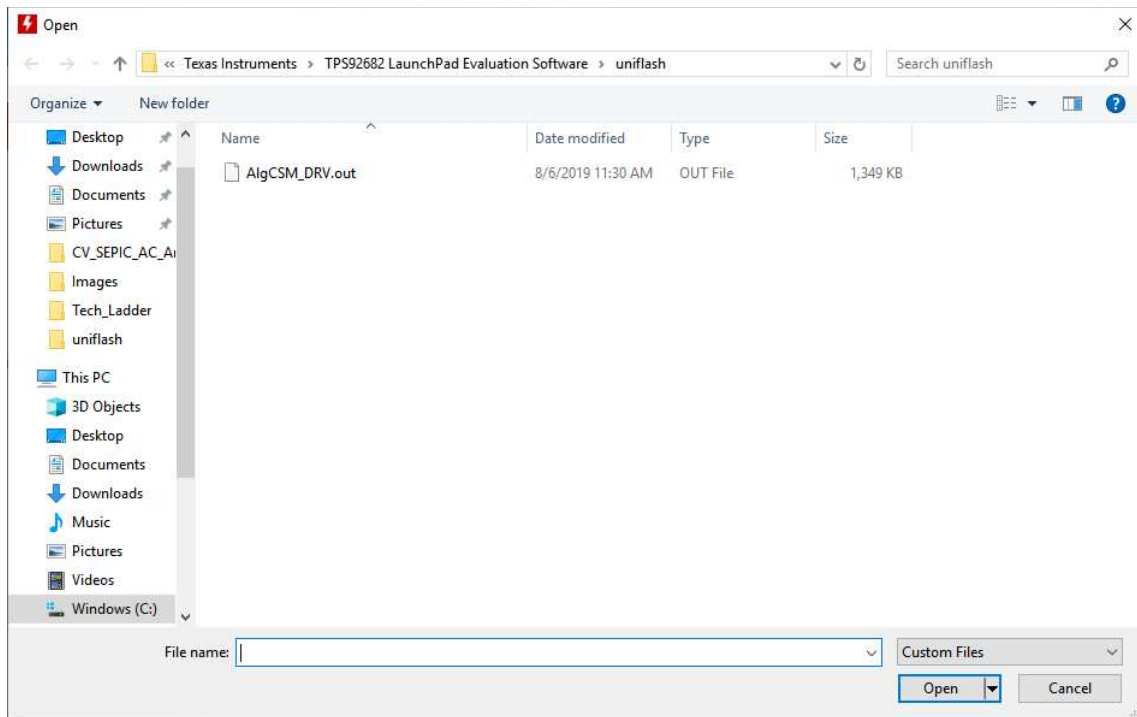

Figure 36. UniFlash Programming, Step 4

8. Click on **Load Image**. After the program loads into the LaunchPad, the *Program Load completed successfully* message appears in the Console, as shown in [Figure 37](#)

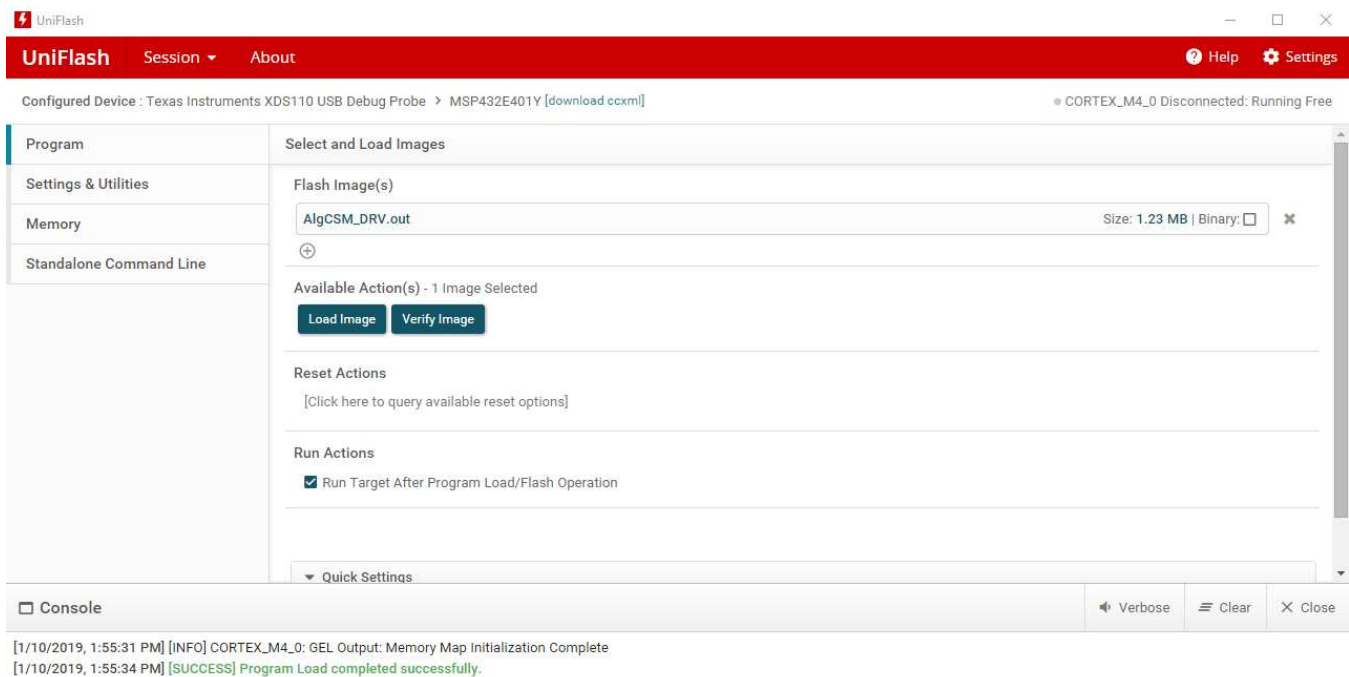

Figure 37. UniFlash Programming, Step 5

9. Close the UniFlash program, disconnect the Micro-USB from the LaunchPad and connect it to the USB port U7 on the other side of the LaunchPad, as shown in [Figure 38](#).

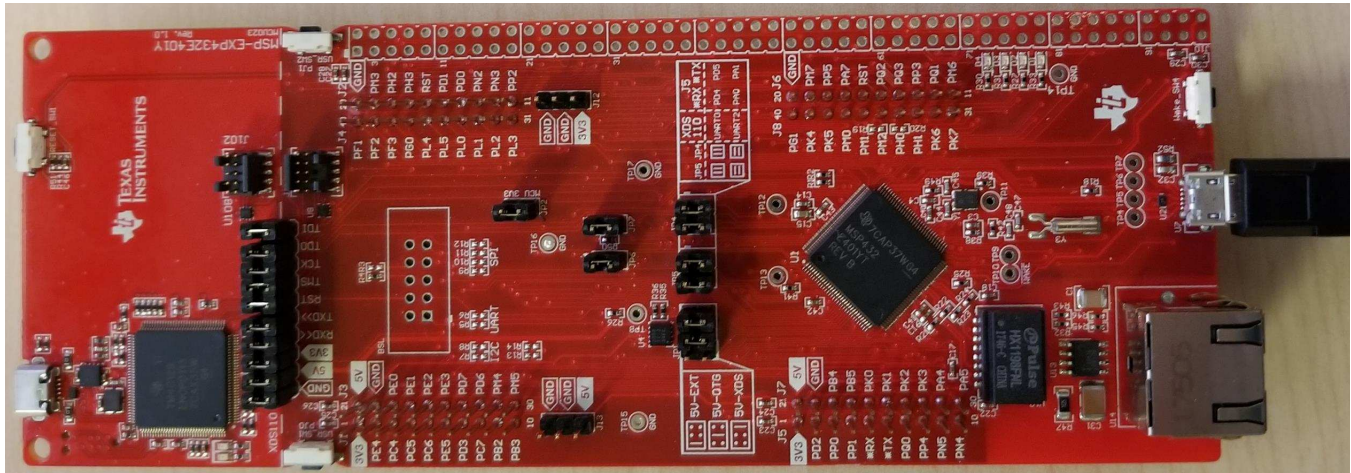

Figure 38. LaunchPad Connection for GUI Operation

8 TPS92682EVM-069 Power UP and Operation

To start the EVM operation, connect the header J5 on TPS92682EVM-069 to the header J2/J4 on the LaunchPad, and the header J7 to the header J1/J3, using two included ribbon cables as shown in Figure 39.

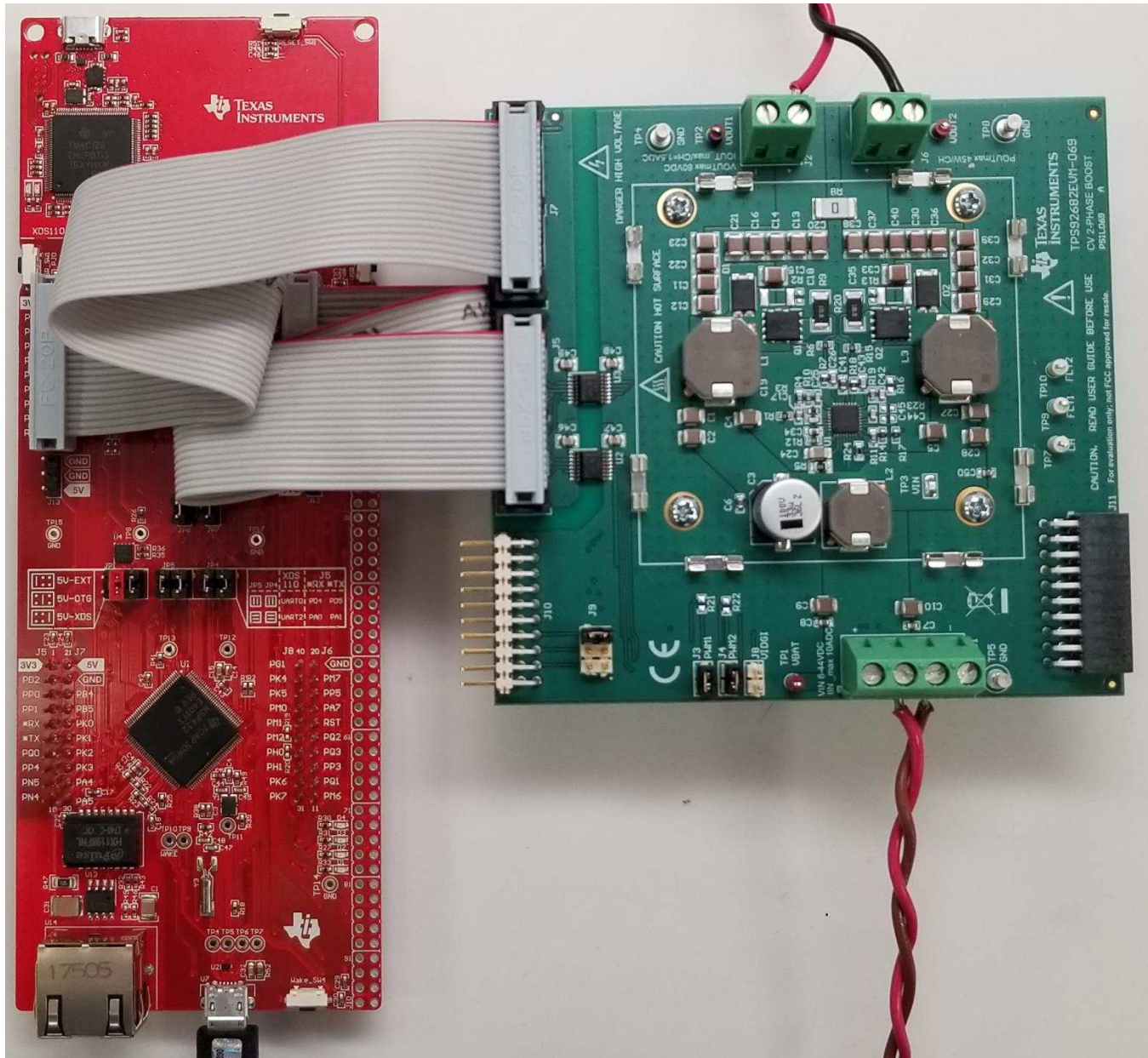

Figure 39. LaunchPad Connection to TPS92682EVM-069

Apply power (12 V) to the TPS92682EVM-069 board (terminal J1). Connect a resistive or a current sink load to the output of the EVM (terminal J2). The load should not exceed maximum output current of 1.5 A and the maximum output power of 90 W for 2-phase operation. The following steps then provide the necessary setup to enable and turn on the TPS92682EVM-069.

Run the program **LED_Controller_GUI_LP.exe**, located at the "*:\Texas Instruments\TPS92682 LaunchPad Evaluation Software*", to start the GUI. The window shown in Figure 40 opens.

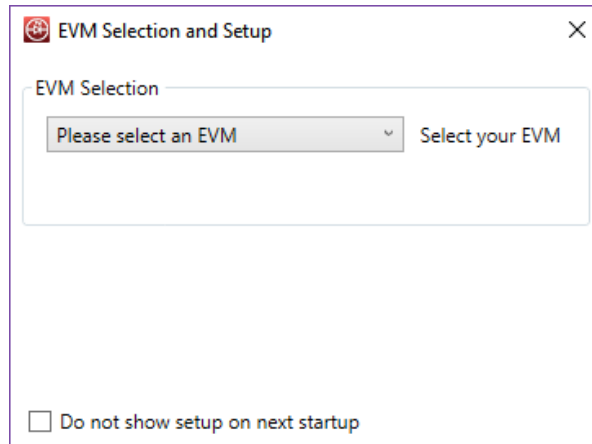

Figure 40. GUI Setup Screen 1

Click on the EVM selection option to select the TPS92682 CV - PSIL069.

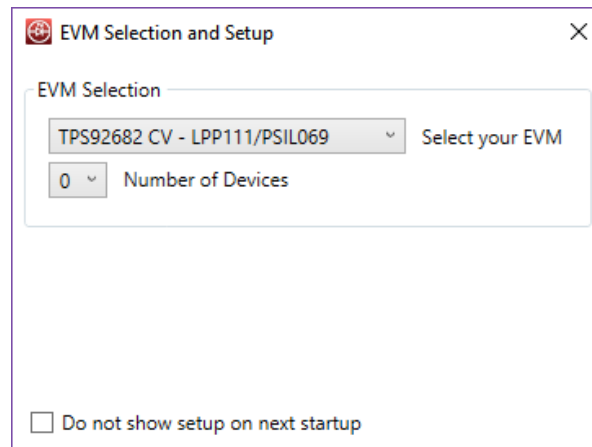

Figure 41. GUI Setup Screen 2

In [Figure 41](#), select 1 for Number of Devices. A new tab will be shown as in [Figure 42](#). Select 682 for Device Type and 0 for Desired Address. Click on Add Device.

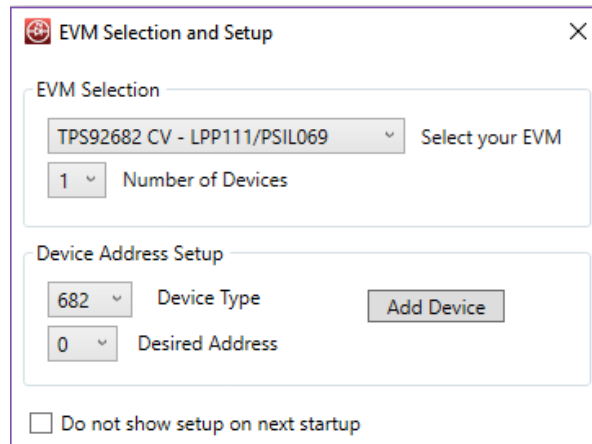

Figure 42. GUI Setup Screen 3

The main GUI window should now appear as shown in [Figure 43](#). This window include three sub-windows:

- MCU Control Box (1): is mostly used for Constant Current (CC) Mode EVM and is not used for the TPS92682EVM-069.
- SPI Command Box (2): is used to manually read from and write to the registers on the SPI BUS.
- Devices Box (3): this is the main GUI control window to configure the TPS92682-Q1 device.

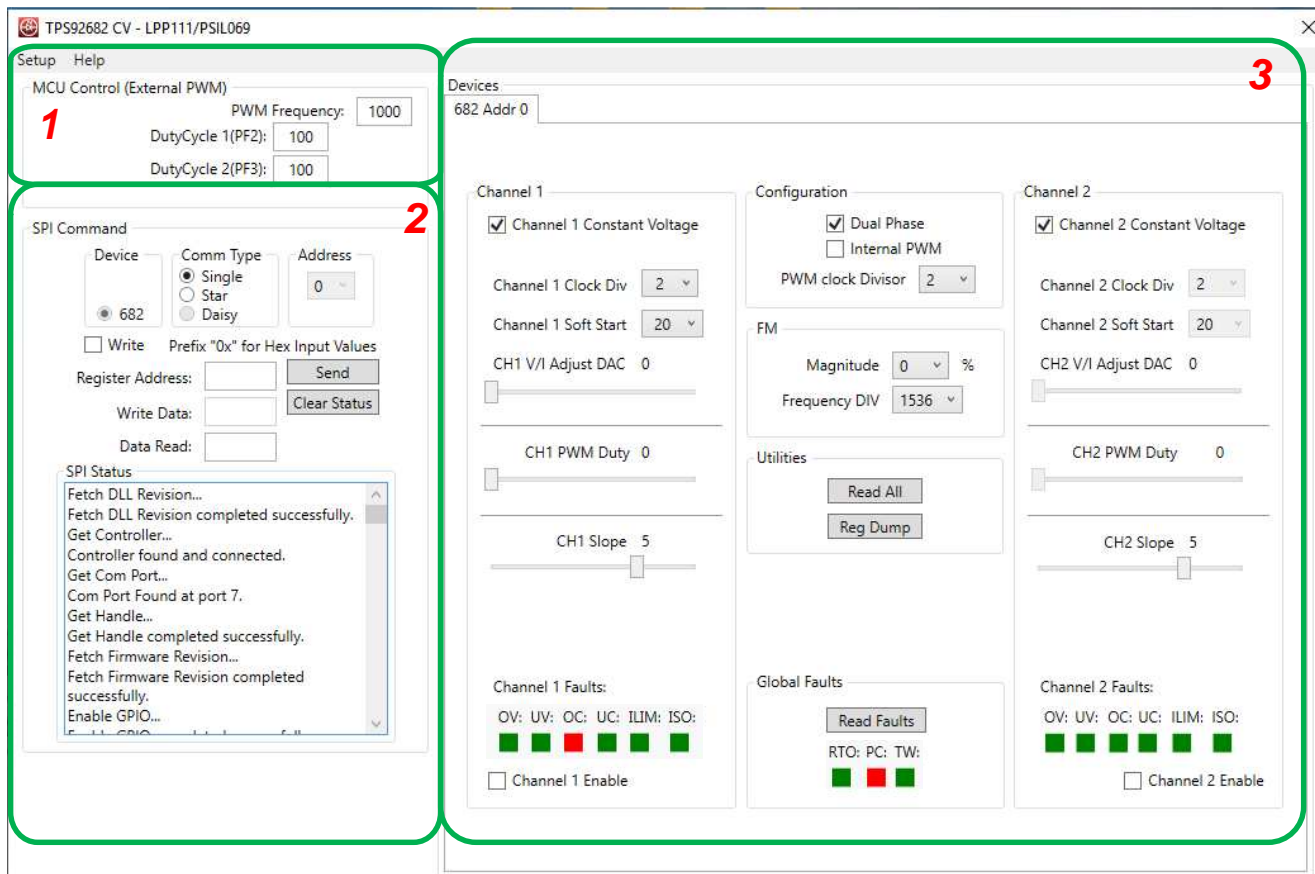

Figure 43. GUI, Main Window

8.1 SPI Command

The SPI command box allows register *read* and *write* actions.

To ensure a connection from the board to the TPS92682-Q1 exists, perform the following steps as shown in [Figure 44](#).

1. Write the register address zero in the *Register Address* box: 0x00.
2. Double-click **Send**.

The default value of 0x3C for the register 0 will be shown in the SPI Status window.

To write data to associated register address:

- Click the check box next to **Write**
- Write the desired data in the box next to **Write Data:** as shown in [Figure 44](#).
- Click **Send**.

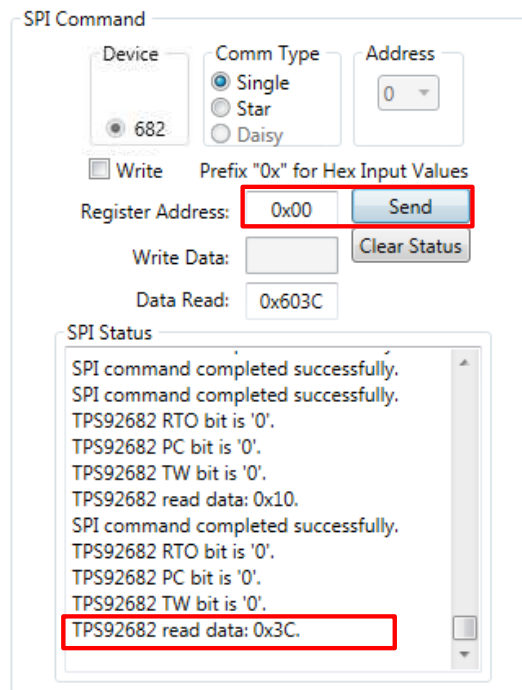
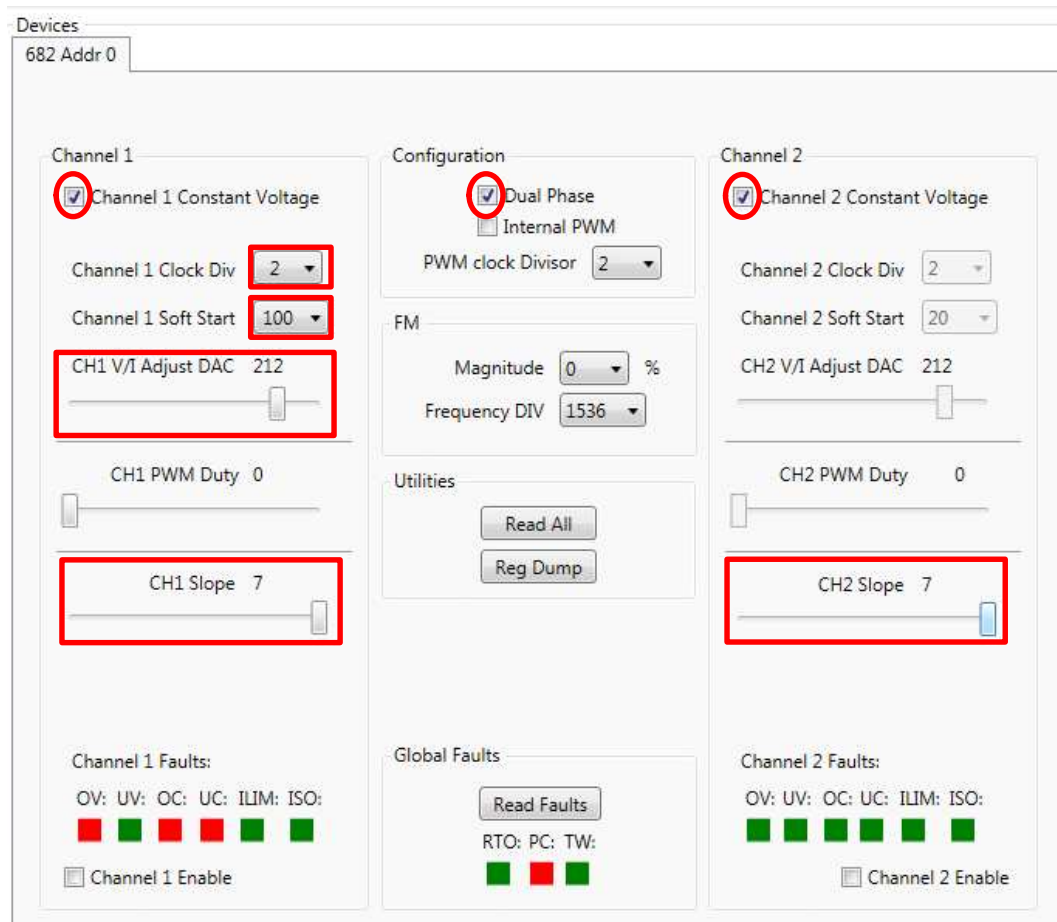

Figure 44. SPI Command Window

8.2 GUI Devices Window

Because TPS92682EVM-069 is configured as a 2-phase CV boost converter, ensure the settings shown in red in Figure 45 are correctly set to turn-on and regulate the output voltage.

The settings shown in Figure 43 are sent to the TPS92682-Q1 when the GUI is started. However, if the power to the TPS92682EVM-069 is off when the GUI is started, the settings are not applied after the power-on of the EVM. To make sure that all the required settings are applied, uncheck and re-check the check-boxes in the GUI control box shown in Figure 43 and Figure 45.

Figure 45. SPI Command Window

1. Set both channels 1 and 2 to constant voltage by clicking on the associated Check boxes
2. Set the configuration to 2-phase by setting the Dual Phase check box
3. By default, the Clock Div is set to “2”, which corresponds with switching frequency of $F_{sw}=200\text{kHz}$.
4. Set the channel-1 soft-start time to “100”. Two-phase mode does not require a soft-start time setting for channel-2. Channel-1 soft-start time is used for both channels in 2-phase mode
5. In 2-phase mode, the output voltage V_{OUT} is set by channel-1 V/I Adjust DAC. Set the DAC to 211 or 212 for $V_{OUT} \approx 50\text{ V}$. The feedback resistors are set on the TPS92682EVM-069, such that the maximum setting of V/IADJ-DAC corresponds to $V_{OUT} \approx 60\text{ V}$.

$$V_O = \left(1 + \frac{R_9}{R_6}\right) \times \frac{VIADJ \times 2.4}{255} \quad (1)$$

6. By default CHx-Slope is set to code “5”, which corresponds with 250mV of peak slope. For the TPS92682EVM-069, it is recommended to set the slopes for both channels to code “7” as shown in [Figure 45](#)

NOTE: The PWM settings in the main GUI window are for the internal PWM setting and are used in CC mode. These settings are not relevant for the TPS92682EVM-069. Do **NOT** select any PWM settings in the main GUI window

After the SPI settings are applied the fault status must be obtained. The GUI shows the fault status registers FLT1 (0x11) and FLT2 (0x12). Before enabling and turning on the output, the fault registers must be read (cleared). The power cycle (PC) bit must be cleared in order for the TPS92682-Q1 to turn on. The fault status can be obtained by clicking **Read Faults** (as shown in [Figure 46](#)).

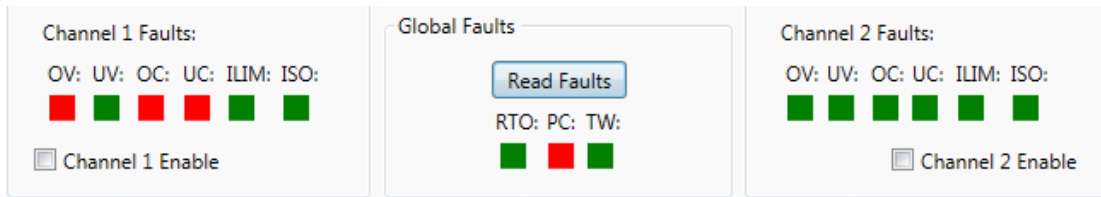

Figure 46. Fault Status after Pushing the Read Faults Once

The first time **Read Fault** is clicked, the previous status of the fault registers are shown and the faults are cleared. The second time **Read Fault** is clicked, the cleared faults change to green as shown in [Figure 47](#).

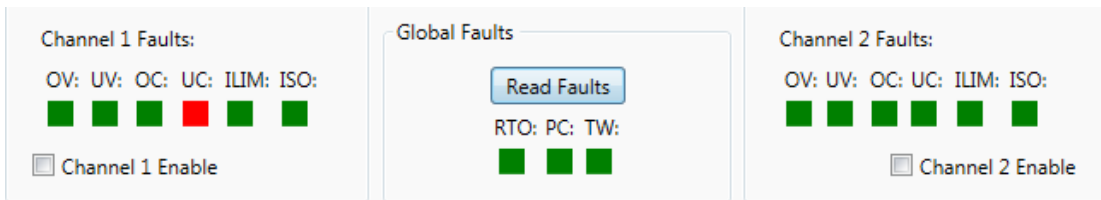

Figure 47. Fault Status after Pushing the Read Faults Twice

Some faults, (such as as undercurrent (UC) and overcurrent (OC))are related to the CC mode and are not relevant in CV mode. Clear the following faults (change status to green) before enabling the TPS92682EVM-069 2-phase CV BOOST.

- output overvoltage (OV)
- output undervoltage (UV)
- cycle-by-cycle current limit (ILIM)
- IS open (ISO)
- RT Open (RTO)
- power cycle (PC)
- thermal warning (TW)

Click the check box next to **Channel 1 Enable**,to turn on the TPS92682EVM-069 and to regulate the output to the desired voltage (50 V, in this example).

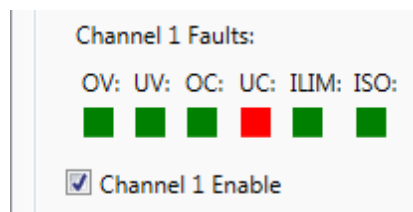

Figure 48. Enabling the EVM

To turn off the TPS92682EVM-069, click **Channel 1 Enable** again to deselect.

NOTE: If a power cycle occurs, all the registers reset to their default values. Be sure to apply all the preliminary steps listed in [Section 8](#) before re-enabling the converter.

Revision History

NOTE: Page numbers for previous revisions may differ from page numbers in the current version.

Changes from Original (March 2019) to A Revision	Page
• <i>Figures 13 to 15</i>	20
• Updated <i>Figure 18</i>	23
• Updated <i>Figures 21 to 25</i>	24
• Updated <i>Figure 30</i>	28
• Updated <i>Figure 34 and Figure 36</i>	31
• Updated <i>Figure 43 and Figure 44</i>	36

STANDARD TERMS FOR EVALUATION MODULES

1. *Delivery:* TI delivers TI evaluation boards, kits, or modules, including any accompanying demonstration software, components, and/or documentation which may be provided together or separately (collectively, an "EVM" or "EVMs") to the User ("User") in accordance with the terms set forth herein. User's acceptance of the EVM is expressly subject to the following terms.
 - 1.1 EVMs are intended solely for product or software developers for use in a research and development setting to facilitate feasibility evaluation, experimentation, or scientific analysis of TI semiconductors products. EVMs have no direct function and are not finished products. EVMs shall not be directly or indirectly assembled as a part or subassembly in any finished product. For clarification, any software or software tools provided with the EVM ("Software") shall not be subject to the terms and conditions set forth herein but rather shall be subject to the applicable terms that accompany such Software
 - 1.2 EVMs are not intended for consumer or household use. EVMs may not be sold, sublicensed, leased, rented, loaned, assigned, or otherwise distributed for commercial purposes by Users, in whole or in part, or used in any finished product or production system.
2. *Limited Warranty and Related Remedies/Disclaimers:*
 - 2.1 These terms do not apply to Software. The warranty, if any, for Software is covered in the applicable Software License Agreement.
 - 2.2 TI warrants that the TI EVM will conform to TI's published specifications for ninety (90) days after the date TI delivers such EVM to User. Notwithstanding the foregoing, TI shall not be liable for a nonconforming EVM if (a) the nonconformity was caused by neglect, misuse or mistreatment by an entity other than TI, including improper installation or testing, or for any EVMs that have been altered or modified in any way by an entity other than TI, (b) the nonconformity resulted from User's design, specifications or instructions for such EVMs or improper system design, or (c) User has not paid on time. Testing and other quality control techniques are used to the extent TI deems necessary. TI does not test all parameters of each EVM. User's claims against TI under this Section 2 are void if User fails to notify TI of any apparent defects in the EVMs within ten (10) business days after delivery, or of any hidden defects with ten (10) business days after the defect has been detected.
 - 2.3 TI's sole liability shall be at its option to repair or replace EVMs that fail to conform to the warranty set forth above, or credit User's account for such EVM. TI's liability under this warranty shall be limited to EVMs that are returned during the warranty period to the address designated by TI and that are determined by TI not to conform to such warranty. If TI elects to repair or replace such EVM, TI shall have a reasonable time to repair such EVM or provide replacements. Repaired EVMs shall be warranted for the remainder of the original warranty period. Replaced EVMs shall be warranted for a new full ninety (90) day warranty period.

WARNING

Evaluation Kits are intended solely for use by technically qualified, professional electronics experts who are familiar with the dangers and application risks associated with handling electrical mechanical components, systems, and subsystems.

User shall operate the Evaluation Kit within TI's recommended guidelines and any applicable legal or environmental requirements as well as reasonable and customary safeguards. Failure to set up and/or operate the Evaluation Kit within TI's recommended guidelines may result in personal injury or death or property damage. Proper set up entails following TI's instructions for electrical ratings of interface circuits such as input, output and electrical loads.

NOTE:

EXPOSURE TO ELECTROSTATIC DISCHARGE (ESD) MAY CAUSE DEGRADATION OR FAILURE OF THE EVALUATION KIT; TI RECOMMENDS STORAGE OF THE EVALUATION KIT IN A PROTECTIVE ESD BAG.

3 Regulatory Notices:

3.1 United States

3.1.1 Notice applicable to EVMs not FCC-Approved:

FCC NOTICE: This kit is designed to allow product developers to evaluate electronic components, circuitry, or software associated with the kit to determine whether to incorporate such items in a finished product and software developers to write software applications for use with the end product. This kit is not a finished product and when assembled may not be resold or otherwise marketed unless all required FCC equipment authorizations are first obtained. Operation is subject to the condition that this product not cause harmful interference to licensed radio stations and that this product accept harmful interference. Unless the assembled kit is designed to operate under part 15, part 18 or part 95 of this chapter, the operator of the kit must operate under the authority of an FCC license holder or must secure an experimental authorization under part 5 of this chapter.

3.1.2 For EVMs annotated as FCC – FEDERAL COMMUNICATIONS COMMISSION Part 15 Compliant:

CAUTION

This device complies with part 15 of the FCC Rules. Operation is subject to the following two conditions: (1) This device may not cause harmful interference, and (2) this device must accept any interference received, including interference that may cause undesired operation.

Changes or modifications not expressly approved by the party responsible for compliance could void the user's authority to operate the equipment.

FCC Interference Statement for Class A EVM devices

NOTE: This equipment has been tested and found to comply with the limits for a Class A digital device, pursuant to part 15 of the FCC Rules. These limits are designed to provide reasonable protection against harmful interference when the equipment is operated in a commercial environment. This equipment generates, uses, and can radiate radio frequency energy and, if not installed and used in accordance with the instruction manual, may cause harmful interference to radio communications. Operation of this equipment in a residential area is likely to cause harmful interference in which case the user will be required to correct the interference at his own expense.

FCC Interference Statement for Class B EVM devices

NOTE: This equipment has been tested and found to comply with the limits for a Class B digital device, pursuant to part 15 of the FCC Rules. These limits are designed to provide reasonable protection against harmful interference in a residential installation. This equipment generates, uses and can radiate radio frequency energy and, if not installed and used in accordance with the instructions, may cause harmful interference to radio communications. However, there is no guarantee that interference will not occur in a particular installation. If this equipment does cause harmful interference to radio or television reception, which can be determined by turning the equipment off and on, the user is encouraged to try to correct the interference by one or more of the following measures:

- Reorient or relocate the receiving antenna.
- Increase the separation between the equipment and receiver.
- Connect the equipment into an outlet on a circuit different from that to which the receiver is connected.
- Consult the dealer or an experienced radio/TV technician for help.

3.2 Canada

3.2.1 For EVMs issued with an Industry Canada Certificate of Conformance to RSS-210 or RSS-247

Concerning EVMs Including Radio Transmitters:

This device complies with Industry Canada license-exempt RSSs. Operation is subject to the following two conditions:

(1) this device may not cause interference, and (2) this device must accept any interference, including interference that may cause undesired operation of the device.

Concernant les EVMs avec appareils radio:

Le présent appareil est conforme aux CNR d'Industrie Canada applicables aux appareils radio exempts de licence. L'exploitation est autorisée aux deux conditions suivantes: (1) l'appareil ne doit pas produire de brouillage, et (2) l'utilisateur de l'appareil doit accepter tout brouillage radioélectrique subi, même si le brouillage est susceptible d'en compromettre le fonctionnement.

Concerning EVMs Including Detachable Antennas:

Under Industry Canada regulations, this radio transmitter may only operate using an antenna of a type and maximum (or lesser) gain approved for the transmitter by Industry Canada. To reduce potential radio interference to other users, the antenna type and its gain should be so chosen that the equivalent isotropically radiated power (e.i.r.p.) is not more than that necessary for successful communication. This radio transmitter has been approved by Industry Canada to operate with the antenna types listed in the user guide with the maximum permissible gain and required antenna impedance for each antenna type indicated. Antenna types not included in this list, having a gain greater than the maximum gain indicated for that type, are strictly prohibited for use with this device.

Concernant les EVMs avec antennes détachables

Conformément à la réglementation d'Industrie Canada, le présent émetteur radio peut fonctionner avec une antenne d'un type et d'un gain maximal (ou inférieur) approuvé pour l'émetteur par Industrie Canada. Dans le but de réduire les risques de brouillage radioélectrique à l'intention des autres utilisateurs, il faut choisir le type d'antenne et son gain de sorte que la puissance isotrope rayonnée équivalente (p.i.r.e.) ne dépasse pas l'intensité nécessaire à l'établissement d'une communication satisfaisante. Le présent émetteur radio a été approuvé par Industrie Canada pour fonctionner avec les types d'antenne énumérés dans le manuel d'usage et ayant un gain admissible maximal et l'impédance requise pour chaque type d'antenne. Les types d'antenne non inclus dans cette liste, ou dont le gain est supérieur au gain maximal indiqué, sont strictement interdits pour l'exploitation de l'émetteur.

3.3 Japan

3.3.1 *Notice for EVMs delivered in Japan:* Please see http://www.tij.co.jp/lstds/ti_ja/general/eStore/notice_01.page 日本国内に輸入される評価用キット、ボードについては、次のところをご覧ください。
http://www.tij.co.jp/lstds/ti_ja/general/eStore/notice_01.page

3.3.2 *Notice for Users of EVMs Considered "Radio Frequency Products" in Japan:* EVMs entering Japan may not be certified by TI as conforming to Technical Regulations of Radio Law of Japan.

If User uses EVMs in Japan, not certified to Technical Regulations of Radio Law of Japan, User is required to follow the instructions set forth by Radio Law of Japan, which includes, but is not limited to, the instructions below with respect to EVMs (which for the avoidance of doubt are stated strictly for convenience and should be verified by User):

1. Use EVMs in a shielded room or any other test facility as defined in the notification #173 issued by Ministry of Internal Affairs and Communications on March 28, 2006, based on Sub-section 1.1 of Article 6 of the Ministry's Rule for Enforcement of Radio Law of Japan,
2. Use EVMs only after User obtains the license of Test Radio Station as provided in Radio Law of Japan with respect to EVMs, or
3. Use of EVMs only after User obtains the Technical Regulations Conformity Certification as provided in Radio Law of Japan with respect to EVMs. Also, do not transfer EVMs, unless User gives the same notice above to the transferee. Please note that if User does not follow the instructions above, User will be subject to penalties of Radio Law of Japan.

【無線電波を送信する製品の開発キットをお使いになる際の注意事項】 開発キットの中には技術基準適合証明を受けていないものがあります。技術適合証明を受けていないものご使用に際しては、電波法遵守のため、以下のいずれかの措置を取っていただく必要がありますのでご注意ください。

1. 電波法施行規則第6条第1項第1号に基づく平成18年3月28日総務省告示第173号で定められた電波暗室等の試験設備でご使用いただく。
2. 実験局の免許を取得後ご使用いただく。
3. 技術基準適合証明を取得後ご使用いただく。

なお、本製品は、上記の「ご使用にあたっての注意」を譲渡先、移転先に通知しない限り、譲渡、移転できないものとします。

上記を遵守頂けない場合は、電波法の罰則が適用される可能性があることをご留意ください。日本テキサス・インスツルメンツ株式会社
東京都新宿区西新宿 6 丁目 2 4 番 1 号
西新宿三井ビル

3.3.3 *Notice for EVMs for Power Line Communication:* Please see http://www.tij.co.jp/lstds/ti_ja/general/eStore/notice_02.page 電力線搬送波通信についての開発キットをお使いになる際の注意事項については、次のところをご覧ください。
http://www.tij.co.jp/lstds/ti_ja/general/eStore/notice_02.page

3.4 European Union

3.4.1 *For EVMs subject to EU Directive 2014/30/EU (Electromagnetic Compatibility Directive):*

This is a class A product intended for use in environments other than domestic environments that are connected to a low-voltage power-supply network that supplies buildings used for domestic purposes. In a domestic environment this product may cause radio interference in which case the user may be required to take adequate measures.

-
- 4 *EVM Use Restrictions and Warnings:*
 - 4.1 EVMS ARE NOT FOR USE IN FUNCTIONAL SAFETY AND/OR SAFETY CRITICAL EVALUATIONS, INCLUDING BUT NOT LIMITED TO EVALUATIONS OF LIFE SUPPORT APPLICATIONS.
 - 4.2 User must read and apply the user guide and other available documentation provided by TI regarding the EVM prior to handling or using the EVM, including without limitation any warning or restriction notices. The notices contain important safety information related to, for example, temperatures and voltages.
 - 4.3 *Safety-Related Warnings and Restrictions:*
 - 4.3.1 User shall operate the EVM within TI's recommended specifications and environmental considerations stated in the user guide, other available documentation provided by TI, and any other applicable requirements and employ reasonable and customary safeguards. Exceeding the specified performance ratings and specifications (including but not limited to input and output voltage, current, power, and environmental ranges) for the EVM may cause personal injury or death, or property damage. If there are questions concerning performance ratings and specifications, User should contact a TI field representative prior to connecting interface electronics including input power and intended loads. Any loads applied outside of the specified output range may also result in unintended and/or inaccurate operation and/or possible permanent damage to the EVM and/or interface electronics. Please consult the EVM user guide prior to connecting any load to the EVM output. If there is uncertainty as to the load specification, please contact a TI field representative. During normal operation, even with the inputs and outputs kept within the specified allowable ranges, some circuit components may have elevated case temperatures. These components include but are not limited to linear regulators, switching transistors, pass transistors, current sense resistors, and heat sinks, which can be identified using the information in the associated documentation. When working with the EVM, please be aware that the EVM may become very warm.
 - 4.3.2 EVMs are intended solely for use by technically qualified, professional electronics experts who are familiar with the dangers and application risks associated with handling electrical mechanical components, systems, and subsystems. User assumes all responsibility and liability for proper and safe handling and use of the EVM by User or its employees, affiliates, contractors or designees. User assumes all responsibility and liability to ensure that any interfaces (electronic and/or mechanical) between the EVM and any human body are designed with suitable isolation and means to safely limit accessible leakage currents to minimize the risk of electrical shock hazard. User assumes all responsibility and liability for any improper or unsafe handling or use of the EVM by User or its employees, affiliates, contractors or designees.
 - 4.4 User assumes all responsibility and liability to determine whether the EVM is subject to any applicable international, federal, state, or local laws and regulations related to User's handling and use of the EVM and, if applicable, User assumes all responsibility and liability for compliance in all respects with such laws and regulations. User assumes all responsibility and liability for proper disposal and recycling of the EVM consistent with all applicable international, federal, state, and local requirements.
 5. *Accuracy of Information:* To the extent TI provides information on the availability and function of EVMs, TI attempts to be as accurate as possible. However, TI does not warrant the accuracy of EVM descriptions, EVM availability or other information on its websites as accurate, complete, reliable, current, or error-free.
 6. *Disclaimers:*
 - 6.1 EXCEPT AS SET FORTH ABOVE, EVMS AND ANY MATERIALS PROVIDED WITH THE EVM (INCLUDING, BUT NOT LIMITED TO, REFERENCE DESIGNS AND THE DESIGN OF THE EVM ITSELF) ARE PROVIDED "AS IS" AND "WITH ALL FAULTS." TI DISCLAIMS ALL OTHER WARRANTIES, EXPRESS OR IMPLIED, REGARDING SUCH ITEMS, INCLUDING BUT NOT LIMITED TO ANY EPIDEMIC FAILURE WARRANTY OR IMPLIED WARRANTIES OF MERCHANTABILITY OR FITNESS FOR A PARTICULAR PURPOSE OR NON-INFRINGEMENT OF ANY THIRD PARTY PATENTS, COPYRIGHTS, TRADE SECRETS OR OTHER INTELLECTUAL PROPERTY RIGHTS.
 - 6.2 EXCEPT FOR THE LIMITED RIGHT TO USE THE EVM SET FORTH HEREIN, NOTHING IN THESE TERMS SHALL BE CONSTRUED AS GRANTING OR CONFERRING ANY RIGHTS BY LICENSE, PATENT, OR ANY OTHER INDUSTRIAL OR INTELLECTUAL PROPERTY RIGHT OF TI, ITS SUPPLIERS/LICENSORS OR ANY OTHER THIRD PARTY, TO USE THE EVM IN ANY FINISHED END-USER OR READY-TO-USE FINAL PRODUCT, OR FOR ANY INVENTION, DISCOVERY OR IMPROVEMENT, REGARDLESS OF WHEN MADE, CONCEIVED OR ACQUIRED.
 7. *USER'S INDEMNITY OBLIGATIONS AND REPRESENTATIONS.* USER WILL DEFEND, INDEMNIFY AND HOLD TI, ITS LICENSORS AND THEIR REPRESENTATIVES HARMLESS FROM AND AGAINST ANY AND ALL CLAIMS, DAMAGES, LOSSES, EXPENSES, COSTS AND LIABILITIES (COLLECTIVELY, "CLAIMS") ARISING OUT OF OR IN CONNECTION WITH ANY HANDLING OR USE OF THE EVM THAT IS NOT IN ACCORDANCE WITH THESE TERMS. THIS OBLIGATION SHALL APPLY WHETHER CLAIMS ARISE UNDER STATUTE, REGULATION, OR THE LAW OF TORT, CONTRACT OR ANY OTHER LEGAL THEORY, AND EVEN IF THE EVM FAILS TO PERFORM AS DESCRIBED OR EXPECTED.

8. *Limitations on Damages and Liability:*

8.1 *General Limitations.* IN NO EVENT SHALL TI BE LIABLE FOR ANY SPECIAL, COLLATERAL, INDIRECT, PUNITIVE, INCIDENTAL, CONSEQUENTIAL, OR EXEMPLARY DAMAGES IN CONNECTION WITH OR ARISING OUT OF THESE TERMS OR THE USE OF THE EVMS , REGARDLESS OF WHETHER TI HAS BEEN ADVISED OF THE POSSIBILITY OF SUCH DAMAGES. EXCLUDED DAMAGES INCLUDE, BUT ARE NOT LIMITED TO, COST OF REMOVAL OR REINSTALLATION, ANCILLARY COSTS TO THE PROCUREMENT OF SUBSTITUTE GOODS OR SERVICES, RETESTING, OUTSIDE COMPUTER TIME, LABOR COSTS, LOSS OF GOODWILL, LOSS OF PROFITS, LOSS OF SAVINGS, LOSS OF USE, LOSS OF DATA, OR BUSINESS INTERRUPTION. NO CLAIM, SUIT OR ACTION SHALL BE BROUGHT AGAINST TI MORE THAN TWELVE (12) MONTHS AFTER THE EVENT THAT GAVE RISE TO THE CAUSE OF ACTION HAS OCCURRED.

8.2 *Specific Limitations.* IN NO EVENT SHALL TI'S AGGREGATE LIABILITY FROM ANY USE OF AN EVM PROVIDED HEREUNDER, INCLUDING FROM ANY WARRANTY, INDEMNITY OR OTHER OBLIGATION ARISING OUT OF OR IN CONNECTION WITH THESE TERMS, , EXCEED THE TOTAL AMOUNT PAID TO TI BY USER FOR THE PARTICULAR EVM(S) AT ISSUE DURING THE PRIOR TWELVE (12) MONTHS WITH RESPECT TO WHICH LOSSES OR DAMAGES ARE CLAIMED. THE EXISTENCE OF MORE THAN ONE CLAIM SHALL NOT ENLARGE OR EXTEND THIS LIMIT.

9. *Return Policy.* Except as otherwise provided, TI does not offer any refunds, returns, or exchanges. Furthermore, no return of EVM(s) will be accepted if the package has been opened and no return of the EVM(s) will be accepted if they are damaged or otherwise not in a resalable condition. If User feels it has been incorrectly charged for the EVM(s) it ordered or that delivery violates the applicable order, User should contact TI. All refunds will be made in full within thirty (30) working days from the return of the components(s), excluding any postage or packaging costs.

10. *Governing Law:* These terms and conditions shall be governed by and interpreted in accordance with the laws of the State of Texas, without reference to conflict-of-laws principles. User agrees that non-exclusive jurisdiction for any dispute arising out of or relating to these terms and conditions lies within courts located in the State of Texas and consents to venue in Dallas County, Texas. Notwithstanding the foregoing, any judgment may be enforced in any United States or foreign court, and TI may seek injunctive relief in any United States or foreign court.

Mailing Address: Texas Instruments, Post Office Box 655303, Dallas, Texas 75265
Copyright © 2019, Texas Instruments Incorporated

IMPORTANT NOTICE AND DISCLAIMER

TI PROVIDES TECHNICAL AND RELIABILITY DATA (INCLUDING DATASHEETS), DESIGN RESOURCES (INCLUDING REFERENCE DESIGNS), APPLICATION OR OTHER DESIGN ADVICE, WEB TOOLS, SAFETY INFORMATION, AND OTHER RESOURCES "AS IS" AND WITH ALL FAULTS, AND DISCLAIMS ALL WARRANTIES, EXPRESS AND IMPLIED, INCLUDING WITHOUT LIMITATION ANY IMPLIED WARRANTIES OF MERCHANTABILITY, FITNESS FOR A PARTICULAR PURPOSE OR NON-INFRINGEMENT OF THIRD PARTY INTELLECTUAL PROPERTY RIGHTS.

These resources are intended for skilled developers designing with TI products. You are solely responsible for (1) selecting the appropriate TI products for your application, (2) designing, validating and testing your application, and (3) ensuring your application meets applicable standards, and any other safety, security, or other requirements. These resources are subject to change without notice. TI grants you permission to use these resources only for development of an application that uses the TI products described in the resource. Other reproduction and display of these resources is prohibited. No license is granted to any other TI intellectual property right or to any third party intellectual property right. TI disclaims responsibility for, and you will fully indemnify TI and its representatives against, any claims, damages, costs, losses, and liabilities arising out of your use of these resources.

TI's products are provided subject to TI's Terms of Sale (www.ti.com/legal/termsofsale.html) or other applicable terms available either on ti.com or provided in conjunction with such TI products. TI's provision of these resources does not expand or otherwise alter TI's applicable warranties or warranty disclaimers for TI products.

Mailing Address: Texas Instruments, Post Office Box 655303, Dallas, Texas 75265
Copyright © 2019, Texas Instruments Incorporated