

PD30CTBR35BPxxIO - IO-Link



Photoelectric Background Suppression Long Range sensors with IO-Link communication



Description

The PD30CTBR35BPxxIO are a part of the latest generation of high performance photoelectric sensors designed to solve most detection tasks due to the new IO-Link features.

The sensors are implemented in the compact 10 x 20 x 30 mm ABS housing that are acknowledged world wide.

New implemented functions with weight on functionality, reliability, Predictive maintenance make these sensors ideal for Industry 4.0.

Benefits

- **Red Background suppression Long Range** sensor with IO-Link with a adjustable distance of 25 to 360 mm, either by trimmer or via IO-Link.
- **Application functions:** Pattern Recognition, Speed & Length, Divider function and Object & Gap Monitoring.
- **Neighbour Immunity**, selectable up to 3 sensors
- **Easy customization** to specific OEM requests by use of the build in IO-Link functionalities.
- **The output can be operated** either as a standard switching output or in IO-Link mode.
- **Fully configurable via output IO-Link v 1.1.** Electrical outputs can be configured as PNP / NPN / Push-Pull / External input, normally open or normally closed.
- **Timer functions** can be set, such as ON-delay, Off-delay, and one shots.
- **Logging functions:** Temperatures, detecting counter, power cycles and operating hours.
- **Detection modes** Single point, two point, windows and foreground suppression (FGS) mode.
- **Logic functions:** AND, OR, XOR and Gated SR-FF.
- **Analogue output:** In IO-Link mode the sensor will generate 16 bit analogue process data output representing various selectable process data such as received signal level.



Applications

Pattern Recognition: An easy way to verify that a product is manufactured to the specification e.g. Furniture production where tabs or holes has to be with a defined pattern.

Speed and Length: Monitor the speed and length of an object on a conveyour for e.g. sorting on size.

Divider function: A de-central counting function that gives a signal when a preset count level is reached e.g. when a certain items are packed in a carton box it ask for a new box.

Object and Gap Monitoring: Function that can sort out good objects and gaps between them so e.g. a packaging machine only receive objects with the correct size and gaps.

Main functions

- Detects presence or absence of objects that cut off the light from the emitter
- The detection distance is very independent of the colour of the object to detect.
- The sensor can be operated in IO-Link mode once connected to an IO-Link master or in standard I/O mode.



- Received sensing distance as process data.
- Neighbor inference protection.
- Sensing distance by potentiometer, teach by wire or by IO-link parameter.
- Quality of Run and Quality of Teach result.
- Temperature date for preventive maintenance.
- Front-end check for preventive maintenance.

Adjustable parameters via IO-Link interface:

- Sensing distance and hysteresis.
- Sensing modes: single point or two point or window mode.
- Timer functions, e.g.: On-delay, Off delay, One shot leading edge or trailing edge.
- Logic functions such as: AND, OR, X-OR and SR-FF.
- External input.
- Logging functions: Maximum temperatures, minimum temperatures, operating hours, operating cycles, power cycles, minutes above maximum temperature, minutes below minimum temperature, etc.
- Auto hysteresis
- Special functions: Pattern Recognition, Speed & Length, Divider function and Object & Gap Monitoring.

References

Product selection key

PD30CTBR35BP **IO**

Enter the code option instead of

| Code | Option | Description |
|--------------------------|--------|--|
| P | - | Sensing principle: Photoelectric sensor |
| D | - | Rectangular housing |
| 30 | - | Length of housing |
| C | - | Plastic housing |
| T | - | Top trimmer |
| B | - | Background suppression |
| R | - | Red light |
| 35 | - | Sensing distance: 350 mm |
| B | - | Selectable functions: NPN, PNP, Push-Pull, External Input (only pin 2) or External teach input (only pin 2) |
| P | - | Selectable: N.O. or N.C. |
| <input type="checkbox"/> | A2 | Cable, 2 m |
| | M5 | Connector M8 |
| IO | - | IO-Link version |

Type selection

| Connec-tion | Housing | Light type | Code |
|-------------|-----------------|------------|-------------------------|
| Cable | Plastic housing | Red | PD30CTBR35BPA2IO |
| Plug | Plastic housing | Red | PD30CTBR35BPM5IO |



Structure

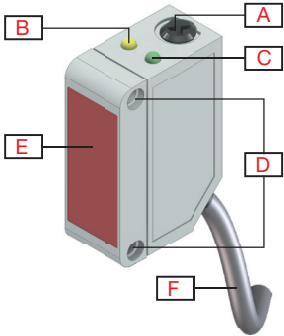

Fig. 1 Cable

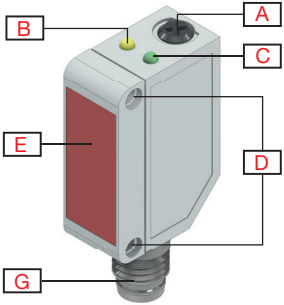

Fig. 2 Plug

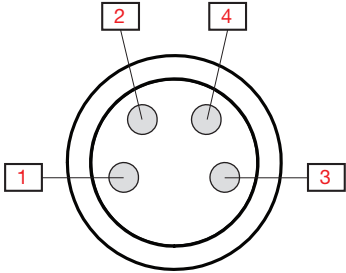

Fig. 3 "M8-plug" Pin numbers

| | | | |
|----------|--------------------------------------|----------|--------------------------|
| A | Sensitivity adjustment (Top trimmer) | G | M8, 4-pin male connector |
| B | Yellow LED | 1 | Brown |
| C | Green LED | 2 | White |
| D | M3 Fixing holes for sensor mounting | 3 | Blue |
| E | Sensing window | 4 | Black |
| F | 2 m, 4 wire PVC Ø 3.3 mm cable | | |



Sensing

Detection

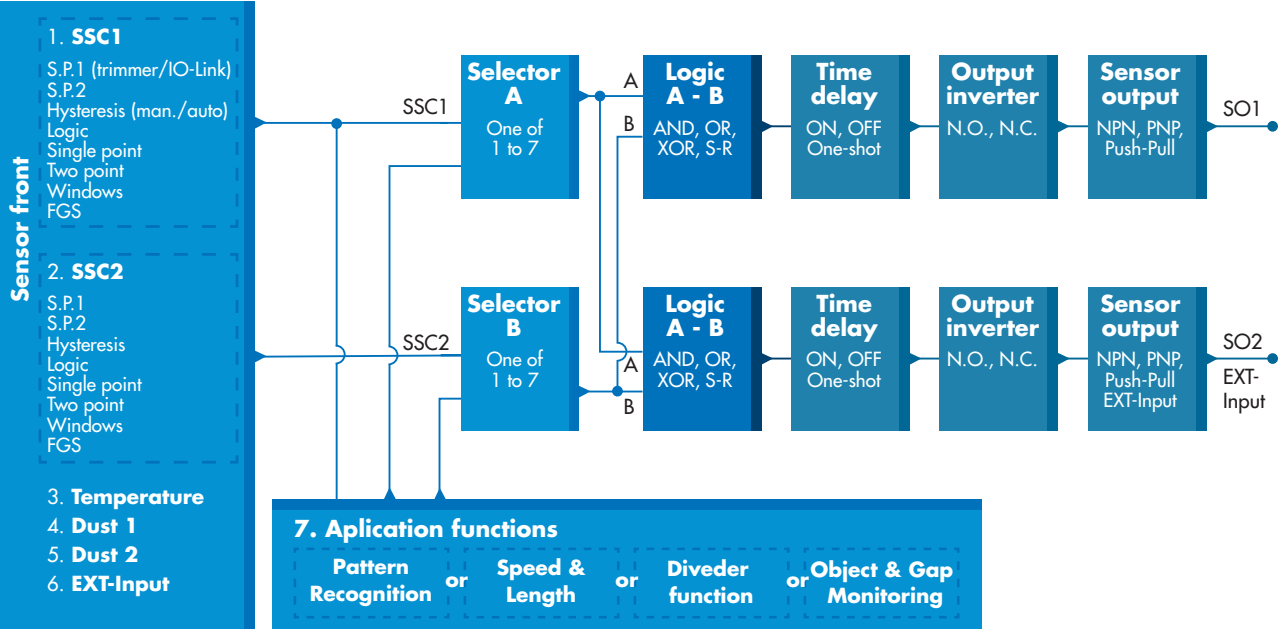



| | | |
|--|---|--|
| Sensor switching channel SSC1 and SSC2 | SSC1 <ul style="list-style-type: none"> • Enabled • Disabled Factory settings: Enabled | SSC2 <ul style="list-style-type: none"> • Enabled • Disabled Factory settings: Enabled |
| Set Point 1 (SP1) | <ul style="list-style-type: none"> • 20 ... 375 Factory settings: 350 (Approx. 350 mm @ Rererence target 90% reflection) | |
| Set Point 2 (SP2) | <ul style="list-style-type: none"> • 20 ... 375 Factory settings: 20 (Approx. 20 mm @ Rererence target 90% reflection) | |
| Switching logic | <ul style="list-style-type: none"> • High active • Low active Factory settings: High active | |
| Switching mode | SSC1 <ul style="list-style-type: none"> • Deactivated • Single point mode • Two point mode • Windows mode • FGS mode Factory settings: Single point mode | SSC2 <ul style="list-style-type: none"> • Deactivated • Single point mode • Two point mode • Windows mode • FGS mode Factory settings: Single point mode |
| Rated operating distance (S _n) | ≤ 350 mm | Reference target, white paper with 90 % reflectivity, Size 200x200 mm |
| Maximum detection distance | ≤ 350 mm | White object 90% reflection |
| | ≤ 350 mm | Grey object 18% reflection |
| | ≤ 350 mm | Black object 6% reflection |
| Cutoff distance | 20...400 mm Factory settings: 400 mm Measured distance beyond Cutoff distance, will be truncated to Cutoff distance. Cutoff distance value will also be used when an object cannot be detected. | |
| Sensitivity control (selectable between) | <ul style="list-style-type: none"> • IO-Link Adjustment (SSC1) • Trimmer Input (SSC1) • Teach by wire (SSC1) Factory settings: Trimmer Input | |
| Sensitivity adjustment | 23 mm ... 360 mm | Single-turn potentiometer |
| Blind zone | ≤ 10 mm | White object 90% reflection |
| | ≤ 12 mm | Grey object 18% reflection |
| | ≤ 14 mm | Black object 6% reflection |
| Light source / Light type | 620 nm / Red modulated | |
| Detection angle | ± 1.2° @ half sensing distance | @ 100 mm |
| Light spot size | Ø 6.8 mm | @ 100 mm |
| Emitter beam angle | ± 2.0° | @ 100 mm |
| Adjustable distance | 20 ... 375 mm Factory settings: SP1 350 and SP2 20 | White object 90% reflection |
| | 20 ... 375 mm Factory settings: SP1 350 and SP2 20 | Grey object 18% reflection |
| | 20 ... 375 mm Factory settings: SP1 350 and SP2 20 | Black object 6% reflection |
| Hysteresis (H) Manual Automatic | Adjustable by IO-Link <ul style="list-style-type: none"> • 2 mm ... 375 mm Factory settings: 24 mm | |
| Detection filter | This function can increase the immunity towards unstable targets and electromagnetic disturbances: Value can be set from 1 to 255. Factory settings: 1 (1 is max. operating frequency and 255 is min. operating frequency) | |



| | | |
|-------------------------------------|---|----------------------------------|
| Mutual Inteferece Protection | <ul style="list-style-type: none"> • MIP Off • One channel • 2 channels - CH A • 2 channels - CH B • 3 channels - CH A • 3 channels - CH B • 3 channels - CH C | Factory settings: MIP Off |
|-------------------------------------|---|----------------------------------|

Application functions

| | | |
|--|--|---|
| Selectable dedicated applications | <ul style="list-style-type: none"> • No application • Pattern Recognition • Speed and Length • Divider function • Object and Gap Monitoring | Factory settings: No application |
|--|--|---|

Pattern Recognition

| | | |
|-----------------------------|---|--|
| Function description | The Pattern recognition function detects a pattern (e.g. a row of holes or pins) and compare the order with a pre-taached reference pattern. | |
| Conditions | Two sensors (Main sensor and Trigger sensor) are needed for this function. | |
| Settings | <ul style="list-style-type: none"> • The Trigger sensor has to detect the full length of the body that contains the pattern. • The Main sensor has to be aimed at the e.g. holes or pins that constitute the pattern. | |

Speed and Length

| | | |
|-----------------------------|---|--|
| Function description | This function is designed to monitor the length of an object as well as the speed of a conveyour belt. The actual value if the length in [mm] and the speed in [mm/s] are directly available on the IO-Link master. | |
| Conditions | Two sensors (Main sensor and Trigger sensor) are needed for this function. | |
| Settings | Distance between sensors. | 25 ... 150 mm Factory settings: 100 mm |

Divider function

| | | |
|-----------------------------|---|--|
| Function description | This function can be used to e.g. monitor how many items that are packed into a carton box. Once the preset number is reached the sensor gives an output so the full box can be replaced. | |
| Conditions | Only one sensor is needed for this function. | |
| Settings | A counter value must be set in the sensor. | |
| | Counter limit. | 1...60 000 Factory settings: 5 |



Object and Gap Monitoring

| | | |
|-----------------------------|--|--|
| Function description | This function is designed to monitor, that the length of an object and the gap between the following object on a conveyer belt, are within certain limits. | |
| Conditions | Only one sensor is needed for this function. | |
| Settings | An acceptable minimum and maximum time [ms] must be set for both the object size a gap size between two objects represented by the time it takes to pass the sensor. | |
| | Object minimum time. | 10...60 000 ms Factory settings: 500 ms |
| | Object maximum time. | 10...60 000 ms Factory settings: 10 000 ms |
| | Gap minimum time. | 10...60 000 ms Factory settings: 500 ms |
| | Gap maximum time. | 10...60 000 ms Factory settings: 10 000 ms |
| Outputs | Output 1 is active when an object is outside the set limits. Output 2 is active when the gap between two objects is outside the set limits. | |

Alarm settings

| | | |
|--------------------------|--|--|
| Safe limits | SSC1 • 0 ... 100 % of actual SP Factory settings: 4% | SSC2 • 0 ... 100 % of actual SP Factory settings: 5% |
| Dust alarm | Safe limits are used for dust alarm level. | |
| Temperature alarm | <ul style="list-style-type: none"> • High threshold -50 ... +150 °C • Low threshold -50 ... +150 °C Factory settings: High value 70 °C Low value -20 °C | |

Detection diagram

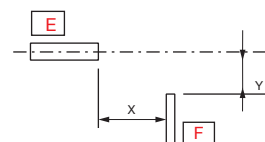
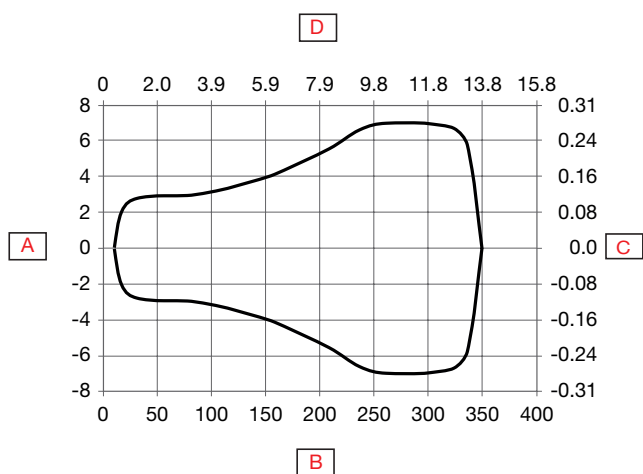

| | | | |
|----------|--------------------------|----------|------------------------------|
| A | Detection width (mm) | D | Sensing range (inches) |
| B | Sensing range (mm) | E | Sensor |
| C | Detection width (inches) | F | Object 25 x 25 mm, White 90% |



Accuracy

| | |
|-------------------|-----------|
| Temperature drift | ≤ 0.2%/°C |
|-------------------|-----------|

Sensing conditions

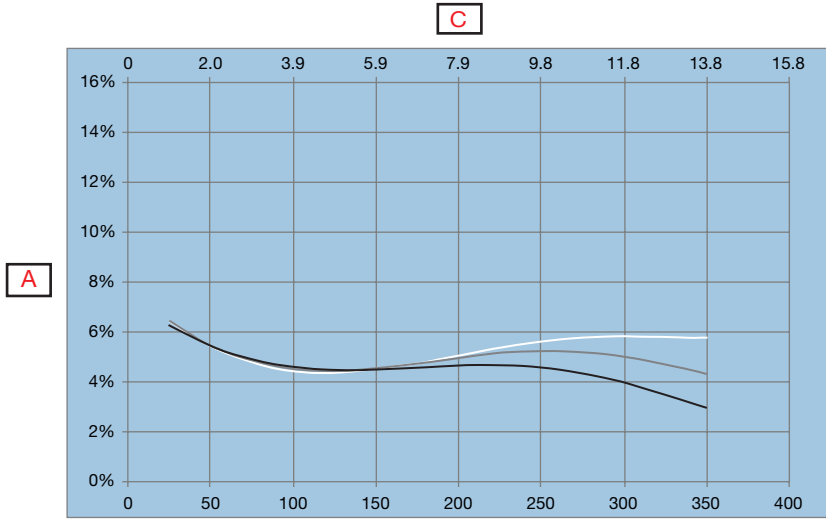

Fig. 4 PD30CTBR35BPxxIO

| | | | |
|----------|-------------------------------|--|--------------------------|
| A | Distance from background (%) | | (Black on white 6%/90%) |
| B | White background 90% (mm) | | (Grey on white 18%/90%) |
| C | White background 90% (inches] | | (White on white 90%/90%) |



Features

▶ Power Supply

| | |
|-------------------------------------|--|
| Rated operational voltage (U_B) | 10 ... 30 VDC (ripple included) |
| Ripple (U_{rpp}) | $\leq 10\%$ |
| No load supply current (I_o) | ≤ 45 mA @ U_B min. ≤ 20 mA @ U_B max. |
| Power-ON delay (t_v) | ≤ 150 ms |

▶ Input selector

| | | |
|----------------|--|--|
| Input selector | Channel A <ul style="list-style-type: none"> • Deactivated • SSC1 • SSC2 • Dust alarm 1 • Dust alarm 2 • Temperature alarm • External input • Application functions Factory settings: SSC1 | Channel B <ul style="list-style-type: none"> • Deactivated • SSC1 • SSC2 • Dust alarm 1 • Dust alarm 2 • Temperature alarm • External input • Application functions Factory settings: SSC1 |
|----------------|--|--|

▶ Logic functions

| | | |
|-----------------|---|---|
| Logic functions | Channel A + B for SO1 <ul style="list-style-type: none"> • Direct • AND • OR • X-OR • SR-FF Factory settings: Direct | Channel A + B for SO2 <ul style="list-style-type: none"> • Direct • AND • OR • X-OR • SR-FF Factory settings: Direct |
|-----------------|---|---|



Time delays

| | | |
|--------------------|---|---|
| Timer mode | For SO1 <ul style="list-style-type: none"> • Disabled • ON delay • OFF delay • ON delay and OFF delay • One-shot leading edge • One-shot trailing edge Factory settings: Disabled | For SO2 <ul style="list-style-type: none"> • Disabled • ON delay • OFF delay • ON delay and OFF delay • One-shot leading edge • One-shot trailing edge Factory settings: Disabled |
| Timer scale | For SO1 <ul style="list-style-type: none"> • [ms] • [s] • [min] Factory settings: ms | For SO2 <ul style="list-style-type: none"> • [ms] • [s] • [min] Factory settings: ms |
| Timer value | For SO1 <ul style="list-style-type: none"> • 0 ... 32 767 Factory settings: 0 | For SO2 <ul style="list-style-type: none"> • 0 ... 32 767 Factory settings: 0 |

Outputs

| | | |
|--|---|--|
| Sensor output | For SO1 Pin 4 Black wire <ul style="list-style-type: none"> • Disabled output • NPN • PNP • Push-Pull Factory settings: PNP | For SO2 Pin 2 White wire <ul style="list-style-type: none"> • Disabled output • NPN • PNP • Push-Pull • External input, active high • External input, active low • External teach • Mute input Factory settings: PNP |
| Output Inverter | For SO1 Pin 4 Black wire <ul style="list-style-type: none"> • N.O. • N.C. Factory settings: N.O. | For SO2 Pin 2 White wire <ul style="list-style-type: none"> • N.O. • N.C. Factory settings: N.C. |
| Rated operational current (I_o) | ≤ 100mA (continuous) pr. output 100 mA @ 100 nF Load (Short-time) pr. output | |
| OFF-state current (I_o) | ≤ 50 µA | |
| Minimum operational current (I_m) | > 0,5 mA | |
| Voltage drop (U_d) | ≤ 1.0 VDC @ 100 mA | |
| Protection | Short circuit, reverse polarity, transients | |
| Utilization category | DC-12 | Control of resistive loads and solid-state loads with optical isolation |
| | DC-13 | Control of electromagnets |
| Capacitive load | 100 nF @ 100 mA, 24 VDC | |

Operation diagram

For default factory sensor

T_v = Power-ON delay



| | | |
|---------------------|---------|--|
| Power supply | ON | |
| Target (Object) | Present | |
| Break output (N.C.) | ON | |
| Make output (N.O.) | ON | |

Response times

| | | |
|-------------------------|----------|----------------------------|
| Operating frequency (f) | ≤ 500 Hz | |
| Response times | ≤ 1 ms | OFF-ON (t _{ON}) |
| | ≤ 1 ms | ON-OFF (t _{OFF}) |

Indication

| Green LED | Yellow LED | Power | Function |
|--|--|-------|--|
| SIO and IO-Link mode | | | |
| ON | ON | ON | ON (stable)* SSC1 |
| ON | OFF | ON | OFF (stable)* SSC1 |
| OFF | OFF | OFF | OFF (Not stable) SSC1 |
| Flashing 1 Hz (10% or 90% duty-cycle) | - | ON | Connected via IO-Link |
| - | Flashing 10 Hz 50% duty-cycle | ON | Output short-circuit |
| - | Flashing 0.5...20 Hz 50% duty-cycle | ON | Timer triggered indication |
| SIO mode only | | | |
| - | Flashing 1 HZ ON 100 ms OFF 900 ms | ON | External teach by wire. Only for single point mode. |
| - | Flashing 1 HZ ON 900 ms OFF 100 ms | ON | Teach time window (3 - 6 sec). |
| - | Flashing 10 HZ ON 50 ms OFF 50 ms Flashing for 2 sec | ON | Teach time out (12 sec). |
| - | Flashing 2 HZ ON 250 ms OFF 250 ms Flashing for 2 sec | ON | Teach successful. |
| O-Link mode only | | | |
| Flashing 1 HZ ON 900 ms OFF 100 ms | - | ON | Sensor is in IO-Link mode. |
| Flashing 2 Hz 50% duty-cycle | | ON | Find my sensor |

*See operation diagram

LED indication

| | |
|---------------------------------|--|
| LED indication selection | <ul style="list-style-type: none"> • LED indication inactive • LED indication active • Find my sensor <p>Factory settings: LED indication active</p> |
|---------------------------------|--|

Environmental

| | | |
|---|--|-----------------------------|
| Ambient temperature | -25° ... +60°C (-13° ... +140°F) | Operating ¹⁾ |
| | -40° ... +85°C (-40° ... +185°F) | Storage ¹⁾ |
| Ambient humidity range | 35% ... 95% | Operating ²⁾ |
| | 35% ... 95% | Storage ²⁾ |
| Ambient light | ≤ 30 000 lux | @ 3000 ... 3200 °K |
| Vibration | 10 ... 150 Hz, 1.0 mm/15 g | EN 60068-2-6 |
| Shock | 30 g _n / 11 ms, 3 pos, 3 neg per axis | EN60068-2-27 |
| Drop test | 2 x 1 m and 100 x 0.5 m | EN 60068-2-31 |
| Rated insulation voltage (U_i) | 50 VDC | |
| Dielectric insulation voltage | ≥ 500 VAC rms | 50/60 Hz for 1 min. |
| Rated impulse withstand voltage | >1 kV (with 500 Ω) | 1.2/50 μs |
| Pollution degree | 3 | IEC60664, 60664A; EN60947-1 |
| Overvoltage category | III | IEC60664; EN60947-1 |
| Degree of protection | IP67 | IEC60539; EN60947-1 |
| NEMA Enclosure Types | 1 | NEMA 250 |

¹⁾ Do not bend the cable in temperatures below -10°C

²⁾ With no icing or condensation

EMC

| | | |
|---|--|--------------------------|
| Electrostatic discharge immunity test | ± 8 kV @ air discharge or ± 4 kV @ contact discharge | IEC 61000-4-2; EN60947-1 |
| Electromagnetic field immunity | 10 V/m | IEC 61000-4-3; EN60947-1 |
| Fast transient immunity | ±2 kV / 5 kHz | IEC 61000-4-4; EN60947-1 |
| Wire-conducted noise | 10 Vrms | IEC 61000-4-3; EN60947-1 |
| Power frequency magnetic field immunity test | Continuous: >30 A/m, 28 μ tesla Short-time: >300 A/m, 280 μ tesla | IEC 61000-4-8; EN60947-1 |



Diagnostic parameters

| Function | Unit | Range |
|---|---|---------------------|
| Sensor Diagnostics | | |
| Frontend Failure | 0 | 0 or 1 |
| Memory Failure | 0 | 0 or 1 |
| Temperature Diagnostics | | |
| Current temperature | [°C] | -50 ... +150 |
| Maximum temperature - All time high | [°C] | -50 ... +150 |
| Minimum temperature - All time low | [°C] | -50 ... +150 |
| Maximum temperature - Since last power-up | [°C] | -50 ... +150 |
| Minimum temperature - Since last power-up | [°C] | -50 ... +150 |
| Minutes above Maximum Temperature | [min] | 0 ... 2 147 483 647 |
| Minutes below Minimum Temperature | [min] | 0 ... 2 147 483 647 |
| Operating Diagnostic | | |
| Operating Hours | [h] | 0 ... 2 147 483 647 |
| Number of Power Cycles | [cycles] | 0 ... 2 147 483 647 |
| Detection counter SSC1 | [cycles] | 0 ... 2 147 483 647 |
| Maintenance event counter | [cycles] | 0 ... 2 147 483 647 |
| Download counter | [counts] | 0 ...65 536 |
| Quality of Teach | - | 0 ... 255% |
| Quality of Run | - | 0 ... 255% |
| Excess gain | | 0.00 ... 1 000.00 |
| Error Count | [counts] | 0 ...65 536 |
| Device Status | 0 = Device is operating properly 1 = Maintenance required 2 = Out-of-specification 3 = Functional-Check 4 = Failure Factory settings: 0 | |

Events Configuration

| Events | Factory default setting |
|-------------------------|-------------------------|
| Maintenance Event | Inactive |
| Temperature fault event | Inactive |
| Temperature over-run | Inactive |
| Temperature under-run | Inactive |
| Short circuit | Inactive |

Observation menu

| Process Data | Factory default setting |
|--------------------------------------|---|
| Analogue value | Analogue value Inactive |
| | Analogue value normal Factory settings |
| | Analogue value as Object Length |
| | Analogue value as Object Speed |
| | Analogue value as Counter value |
| Excess gain | Inactive |
| SO1, Switching output 1 | Active |
| SO2, Switching output 2 | Active |
| SSC1, Sensor switching channel 1 | Inactive |
| SSC2, Sensor switching channel 2 | Inactive |
| DA1, Dust alarm SSC1 | Inactive |
| DA2, Dust alarm SSC2 | Inactive |
| TA, Temperature alarm | Inactive |
| SC, Short circuit | Inactive |
| AFO1, Application functions output 1 | Inactive |

Process data structure

4 Bytes, Analogue value 16 ... 31 (16 bit)

| Byte | 31 | 30 | 29 | 28 | 27 | 26 | 25 | 24 |
|--------|-------------|----|-----------|-----------|------------|------------|-------------|-------------|
| Byte 0 | MSB | - | - | - | - | - | - | - |
| | | | | | | | | |
| Byte 1 | 23 | 22 | 21 | 20 | 19 | 18 | 17 | 16 |
| | - | - | - | - | - | - | - | LSB |
| Byte 2 | 15 | 14 | 13 | 12 | 11 | 10 | 9 | 8 |
| | - | - | SC | TA | DA2 | DA1 | SSC2 | SSC1 |
| Byte 3 | 7 | 6 | 5 | 4 | 3 | 2 | 1 | 0 |
| | AFO1 | - | - | - | - | - | SO2 | SO1 |

Mechanics/electronics

▶ Connection

| | |
|--------------|---|
| Cable | 2 m, 4-wire 4 x 0.14 mm ² , Ø = 3.3 mm, PVC, Black |
| Plug | M8, 4-pin, male |

▶ Wiring

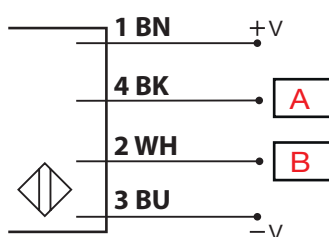

| BN | BK | WH | BU | A | B |
|-------|-------|-------|------|-------------|--------|
| Brown | Black | White | Blue | OUT/IO-Link | IN/OUT |

▶ Housing

| | | |
|----------------------|------------------|---------------|
| Body | ABS | |
| Front glass | PMMA, Red | |
| Trimmer shaft | POM, Grey | |
| Indication | TPU, Transparent | |
| Sealing | NBR70 | |
| Dimensions | 10 x 30 x 20 mm | |
| Weight | ≤ 50 g | Cable version |
| | ≤ 20 g | Plug version |



Dimensions

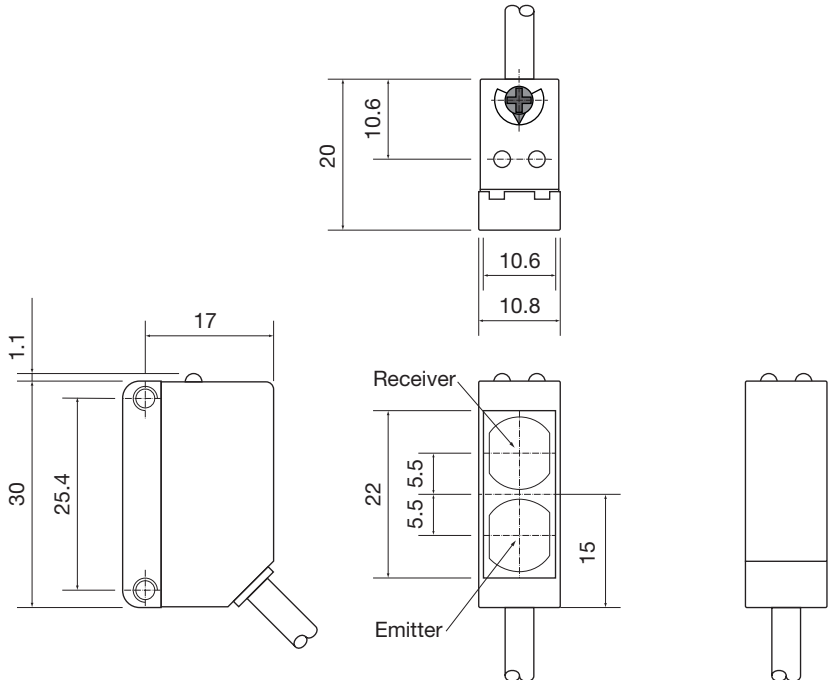

Fig. 5 Cable

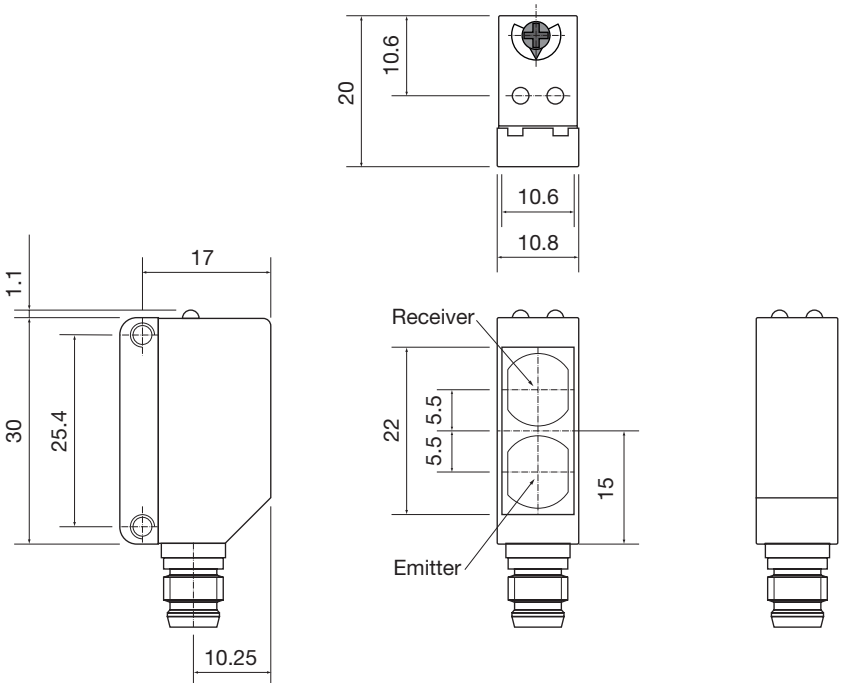



Fig. 6 Plug

Compatibility and conformity

Approvals and markings

| | | |
|--------------------------|---|--------------------------|
| General reference | Sensor designed according to EN60947-5-2 | |
| MTTF_d | 138.5 years | EN ISO 13849-1, SN 29500 |
| CE-marking |  | |
| Approvals |  | |

IO-Link

| | |
|-------------------------------|--|
| IO-Link revision | 1.1 |
| Transmission rate | COM2 (38.4 kbaud) |
| SDCI-Norm | IEC 61131-9 |
| Profile | Smart sensor profile 2nd edition, common profile |
| Min. cycle time | 5 ms |
| SIO mode | Yes |
| Min. master port class | A (4-pin) |
| Process data length | 32 bit |



Delivery contents and accessories



▶ Delivery contents

- Photoelectric switch: PD30CTBR35BPxxIO
- Screwdriver
- Packaging: Plastic bag

▶ Accessories

- Mounting bracket: APD30-MB1 or APD30-MB2 to be purchased separately
- Connector type: CO..54NF... series to be purchased separately

▶ Further information

| Information | Where to find it | QR |
|-------------------|---|---|
| IO-Link manual | http://cga.pub/?93ec5c |  |
| Mounting brackets | http://cga.pub/?6fa29a |  |
| Connectors | http://cga.pub/?0aae3e |  |



COPYRIGHT ©2021
 Content subject to change. Download the PDF: www.gavazziautomation.com