

Typical unit

**To Be Discontinued \***

**FEATURES**

- iLGA inspectable Land Grid Array
- Auto-compensation of feedback loop
- Wide 6.5-14 VDC input range
- Non-isolated output adjustable from 0.6 to 3.3 Volts up to 25 Amps
- Fast dynamic response
- Sync function
- Power good output signal
- Outstanding thermal performance and derating
- Input undervoltage shutdown
- Short circuit protection
- Negative On/Off enable control
- High efficiency at 94% (typ)
- Over temperature protection
- Remote sense
- Certified to UL/IEC 60950-1 safety approvals

**PRODUCT OVERVIEW**

The OKLF-T/25-W12N is a 90.75-Watt SMT non-isolated DC-DC converter for embedded applications featuring auto-compensation and the inspectable Land Grid Array (iLGA) format. The wide input range is 6.5 to 14Vdc. The maximum current is 25 Amps and the output is 0.6 to 3.3V, programmable via an external resistor.

This model features an ultra-fast dynamic response of 30µs (typical 3.3Vout). With auto-compensation, the converter automatically adjusts

the feedback loop to provide optimal transient response. It also makes adjustments to compensate for changes in output capacitance over time, as capacitors age.

Applications include powering CPUs, datacom/telecom systems, programmable logic, networking, telecommunications equipment, and intermediate regulated bus voltage applications.

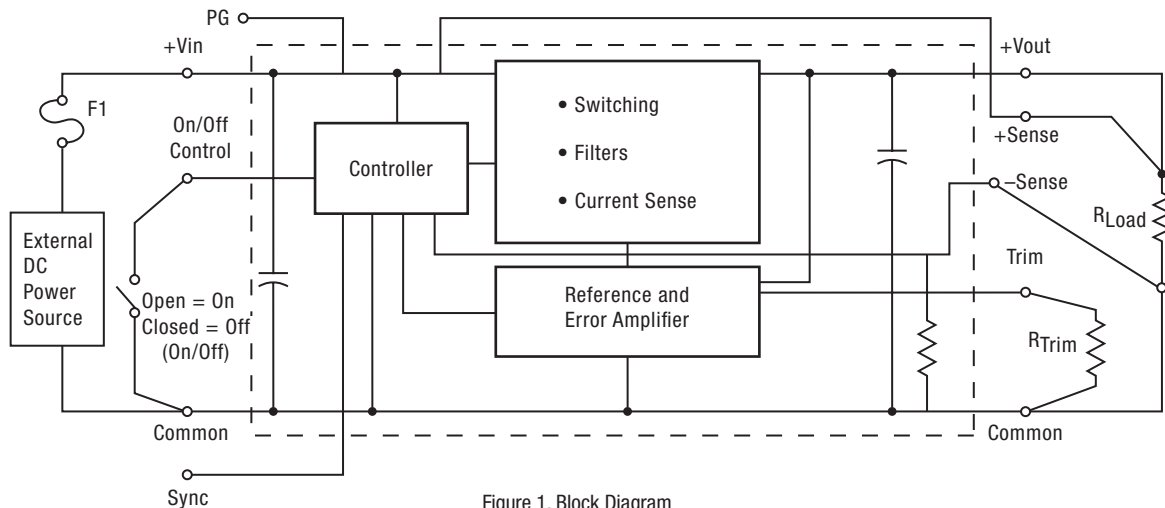

Figure 1. Block Diagram

Note: Murata Power Solutions strongly recommends an external input fuse, F1. See specifications.



**PERFORMANCE SPECIFICATIONS SUMMARY AND ORDERING GUIDE**

Model Number ①	Output					Input				Efficiency		Dimensions inches (mm)	
	Vout (Volts) ①	Iout (Amps, max.) ①	Power (Watts)	R/N (mV p-p) ②	Regulation (max.)		Vin nom. (Volts)	Range (Volts)	Iin, no load (mA)	Iin, full load (Amps)	Min. ③		Typ.
				Max.	Line	Load							
<b>OKLF-T/25-W12N-C</b>	0.6-3.3	25	90.75	25	±0.3%	±0.3%	12	6.5-14	120	8.045	92.5%	94%	1.3 x 0.53 x 0.48 (33x 13.5 x 12.2)

① All specifications are at nominal line voltage, Vout=nominal and full load, +25°C, unless otherwise noted. All models are tested and specified with external 1 µF paralleled with 10 µF ceramic output capacitors and a 22 µF external input capacitor. All capacitors are low ESR types.

② Ripple and Noise (R/N) is shown at Vout=1V. See specs for details.

③ Efficiency is shown for Vin nom, 3.3Vout.

**\* This product is To Be Discontinued. The Last Time Buy date is 3/31/2019. Please click [here](#) to view the Discontinuance Notice.**

**PART NUMBER STRUCTURE**

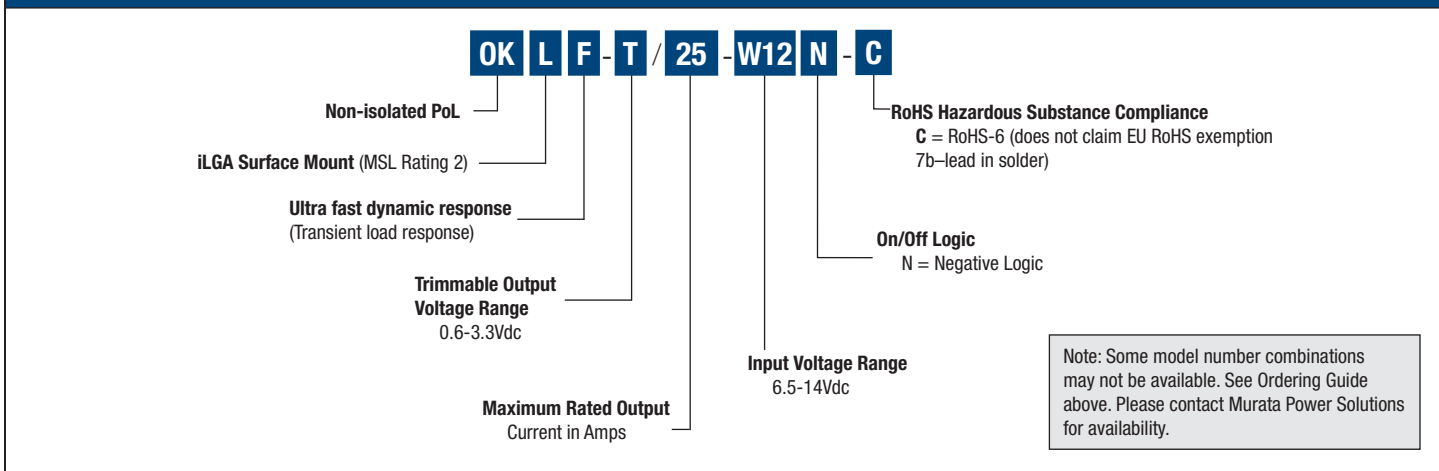

**Product Label**

Because of the small size of these products, the product label contains a character-reduced code to indicate the model number and manufacturing date code. Not all items on the label are always used. Please note that the label differs from the product photograph. Here is the layout of the label:

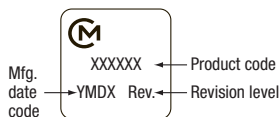

Figure 2. Label Artwork Layout

The label contains three rows of information:

- First row – Murata Power Solutions logo
- Second row – Model number product code (see table)
- Third row – Manufacturing date code and revision level

Model Number	Product Code
OKLF-T/25-W12N-C	F00125

The manufacturing date code is four characters:

- First character – Last digit of manufacturing year, example 2009
- Second character – Month code (1 through 9 = Jan-Sep; O, N, D = Oct, Nov, Dec)
- Third character – Day code (1 through 9 = 1 to 9, 10 = 0 and 11 through 31 = A through Z)
- Fourth character – Manufacturing information

**FUNCTIONAL SPECIFICATIONS**

ABSOLUTE MAXIMUM RATINGS		Conditions ①	Minimum	Typical/Nominal	Maximum	Units
Input voltage, continuous		Full power operation	0		16	Vdc
Input reverse polarity		None, install external fuse		None		Vdc
Output power			0		90.75	W
Output current		Current-limited, no damage, short-circuit protected	0		25	A
Storage temperature range		Vin = Zero (no power)	-55		125	°C
Absolute maximums are stress ratings. Exposure of devices to greater than any of these conditions may adversely affect long-term reliability. Proper operation under conditions other than those listed in the Performance/Functional Specifications Table is not implied nor recommended.						
INPUT		Conditions ① ③				
Operating voltage range			6.5	12	14	Vdc
Recommended external fuse		Fast blow			20	A
Turn on/start-up threshold		Rising input voltage	5.3	5.5	5.7	Vdc
Undervoltage shutdown			5	5.2	5.4	Vdc
Internal filter type				C-TYPE		
Input current						
Full load conditions		Vin = nominal (3.3Vout set)		8.045	8.257	A
Low line		Vin @ min, 3.3 Vout		13.719	15.163	A
Inrush transient				0.14		A <sup>2</sup> -Sec.
Short circuit input current				43		mA
No load input current		3.3Vout, Iout @ 0		120	150	mA
No load input current		0.6V, Iout @ 0		70	100	mA
Shut-down mode input current				30		mA
Reflected (back) ripple current ②		Measured at input with specified filter		37		mA, pk-pk
GENERAL and SAFETY						
Efficiency (12Vin @ 12A load current)		@ Vin nom, 3.3Vout	92.5	94		%
		@ Vin min, 3.3Vout	93	94.5		
		@ Vin nom, 2.5Vout	91.5	93		
		@Vin nom, 1.8Vout	89.5	91		
		@Vin nom, 1.5Vout	88	89.5		
		@Vin nom, 1.2Vout	86	87.5		
Safety		Certified to UL-60950-1, CSA-C22.2 No.60950-1, IEC/60950-1, 2nd edition		Yes		
Calculated MTBF ④		Per Telcordia SR332, issue 1 class 3, ground fixed, Tambient=+25°C		TBD		Hours x 10 <sup>6</sup>
DYNAMIC CHARACTERISTICS						
Switching frequency			475	500	525	KHz
Startup time		Power On to Vout regulated		120		mS
Startup time		Remote ON to 10% Vout		4.9		mS
Dynamic load response		50-100-50% load step, settling time to within ±2% of Vout di/dt = 1 A/μSec. (3.3Vout)		30	50	μSec
Dynamic load peak deviation		same as above		100	200	mV
FEATURES and OPTIONS						
Remote On/Off Control ⑤						
"N" suffix:						
Negative Logic, ON state		Pin open=ON	0		1	V
Negative Logic, OFF state			1.5		+Vin	V
Control Pin Shutdown Current		open collector/drain		0.33		mA
Power Good (standard)						
Vout Window for PGOOD: True		PGOOD, Open Drain Configuration, Sinking	-10		+10	%
Vout Window for PGOOD: False				0.05		V

OUTPUT	Conditions ①	Minimum	Typical/Nominal	Maximum	Units
<b>Total Output Power</b>		0	90.75	90.75	W
<b>Voltage</b>					
<b>Nominal Output Voltage Range</b>	See trim formula	0.6		3.3	Vdc
<b>Setting Accuracy</b>	At 50% load, except 0.6Vout	-1		1	% of Vnom.
<b>Output Voltage Overshoot - Startup</b>				1	%Vo nom
<b>Current</b>					
<b>Output Current Range</b>		0	25	25	A
<b>Minimum Load</b>			No minimum load		
<b>Current Limit Inception ⑥</b>	98% of Vnom., after warmup @3.3Vout	27.6	32.6	37.6	A
<b>Short Circuit</b>					
<b>Short Circuit Current ⑦</b>	Hiccup technique, autorecovery within ±1% of Vout		0.14		A
<b>Short Circuit Duration (remove short for recovery)</b>	Output shorted to ground, no damage		Continuous		
<b>Short circuit protection method</b>	Current limiting				
<b>Regulation</b>					
<b>Line Regulation</b>	Vin=min. to max. Vout=nom.			±0.3	%
<b>Load Regulation</b>	Iout=min. to max.			±0.3	%
<b>Ripple and Noise ⑧</b>	3.3Vo, 12Vin			65	mV pk-pk
	1.8Vo, 12Vin			40	mV pk-pk
	1Vo, 12Vin			25	mV pk-pk
<b>Temperature Coefficient</b>	At all outputs		±0.02		% of Vnom./°C
<b>Maximum Capacitive Loading</b>	ESR > 15mohm			5000	µF
	Low ESR		3000		µF
<b>MECHANICAL (Through Hole Models) Conditions ① ③</b>					
<b>Outline Dimensions</b>	LxWxH (Please refer to outline drawing)		1.3x0.53x0.48		Inches
			33x13.5x12.19		mm
<b>Weight</b>			0.0163		Ounces
			7.39		Grams
<b>ENVIRONMENTAL</b>					
<b>Operating Ambient Temperature Range</b>	full power, all output voltages; see derating curves	-40		85	°C
<b>Operating PCB Temperature</b>	No derating	-40		100	°C
<b>Storage Temperature</b>	Vin = Zero (no power)	-55		125	°C
<b>Thermal Protection/Shutdown</b>	Measured in center	130	130	135	°C

## Notes

- ① Specifications are typical at +25 deg.C, Vin=nominal (+12V), Vout=nominal (+3.3V), full load, external caps and natural convection unless otherwise indicated. Extended tests at higher power must supply substantial forced airflow.
- All models are tested and specified with external 1 µF paralleled with 10 µF ceramic output capacitors and a 22 µF external input capacitor. All capacitors are low ESR types. These capacitors are necessary to accommodate our test equipment and may not be required to achieve specified performance in your applications. However, Murata Power Solutions recommends installation of these capacitors. All models are stable and regulate within spec under no-load conditions.
- ② Input Back Ripple Current is tested and specified over a 5 Hz to 20 MHz bandwidth. Input filtering is Cin=2 x 100 µF tantalum, Cbus=1000 µF electrolytic, Lbus=1 µH.
- ③ Note that Maximum Power Derating curves indicate an average current at nominal input voltage. At higher temperatures and/or lower airflow, the DC/DC converter will tolerate brief full current outputs if the total RMS current over time does not exceed the Derating curve.

- ④ Mean Time Before Failure is calculated using the Telcordia (Belcore) SR-332 Method 1, Case 3, ISSUE 2, ground fixed controlled conditions, Tambient=+25 deg.C, full output load, natural air convection.
- ⑤ The On/Off Control Input should use either a switch or an open collector/open drain transistor referenced to -Input Common. A logic gate may also be used by applying appropriate external voltages which not exceed +Vin.
- ⑥ Short circuit shutdown begins when the output voltage degrades approximately 1% from the selected setting.
- ⑦ "Hiccup" overcurrent operation repeatedly attempts to restart the converter with a brief, full-current output. If the overcurrent condition still exists, the restart current will be removed and then tried again. This short current pulse prevents overheating and damaging the converter. Once the fault is removed, the converter immediately recovers normal operation.
- ⑧ Output noise may be further reduced by adding an external filter. At zero output current, the output may contain low frequency components which exceed the ripple specification. The output may be operated indefinitely with no load.

**TYPICAL PERFORMANCE DATA**

Efficiency vs. Line Voltage and Load Current @ +25°C. (Vout = 3.3V)

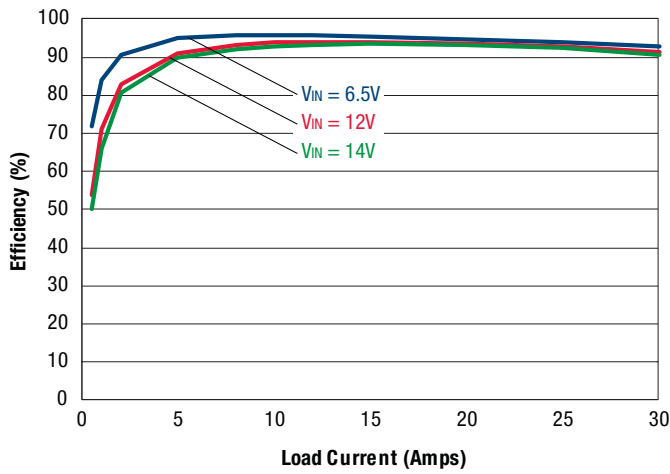

Efficiency vs. Line Voltage and Load Current @ +25°C. (Vout = 2.5V)

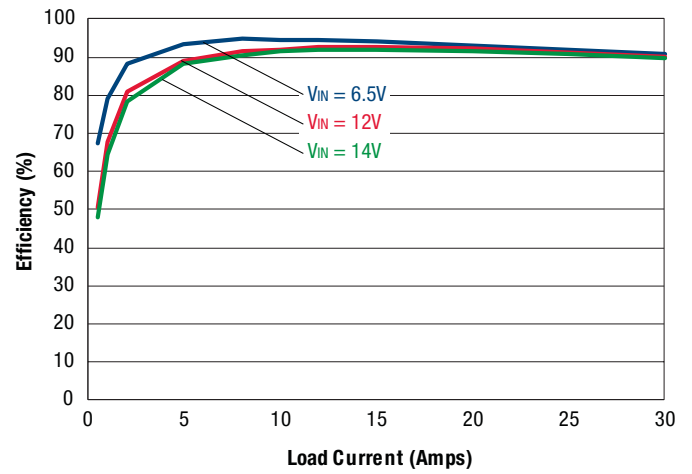

Efficiency vs. Line Voltage and Load Current @ +25°C. (Vout = 1.8V)

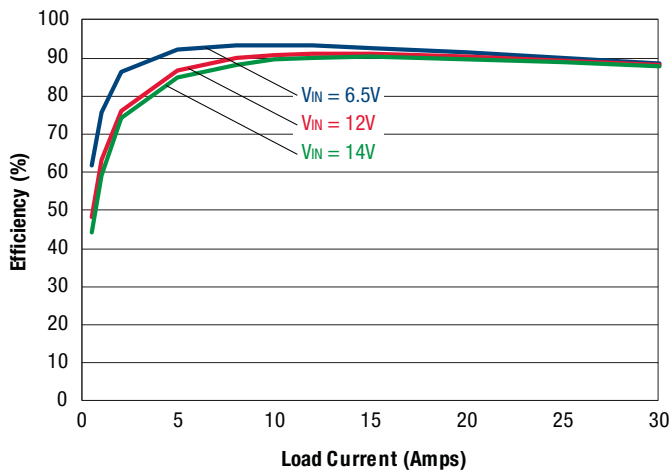

Efficiency vs. Line Voltage and Load Current @ +25°C. (Vout = 1.2V)

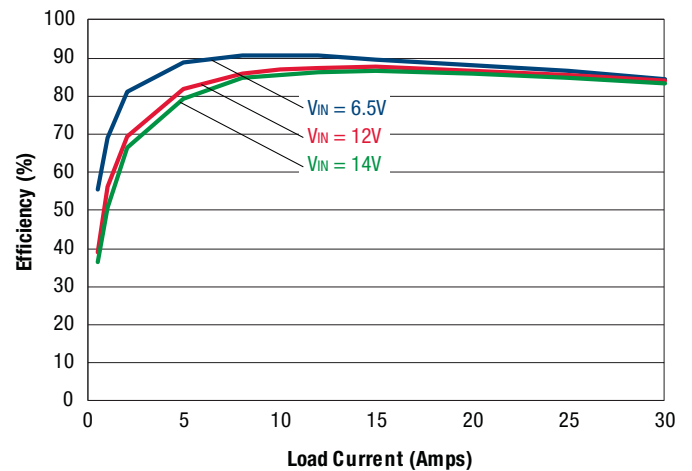

Efficiency vs. Line Voltage and Load Current @ +25°C. (Vout = 1.0V)

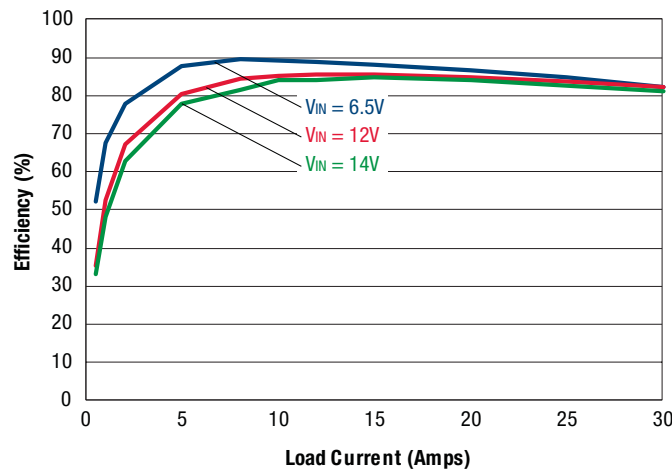

**TYPICAL PERFORMANCE DATA**

Maximum Current Temperature Derating at Sea Level (Vin=12V, Vout=3.3V)

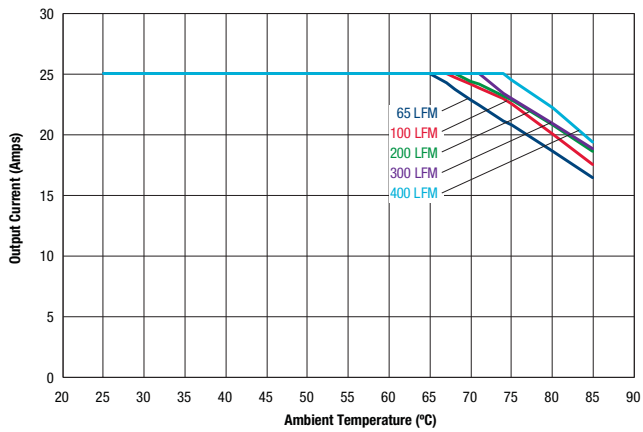

Maximum Current Temperature Derating at Sea Level (Vin=12V, Vout=2.5V)

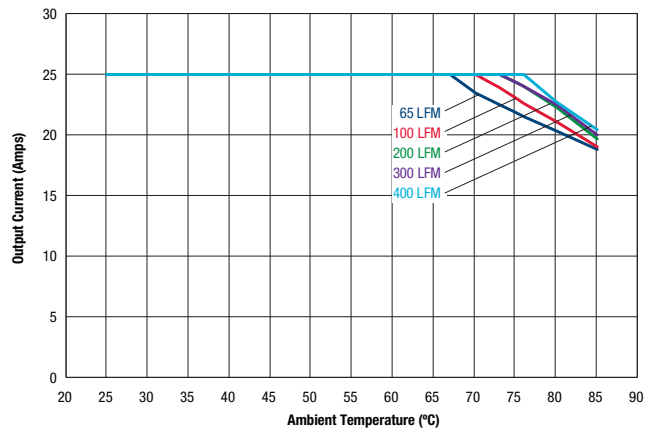

Maximum Current Temperature Derating at Sea Level (Vin=12V, Vout=1.8V)

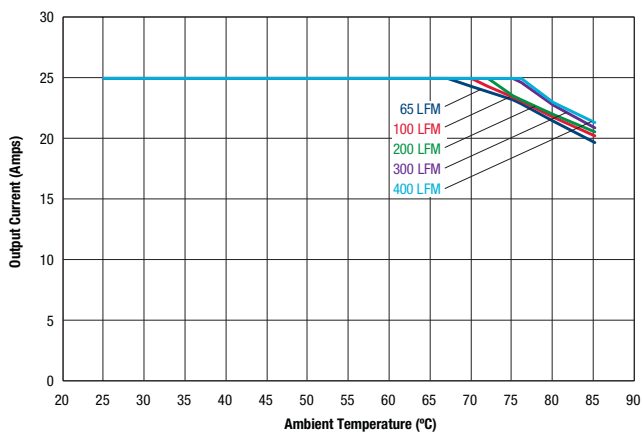

Maximum Current Temperature Derating at Sea Level (Vin=12V, Vout=1.2V)

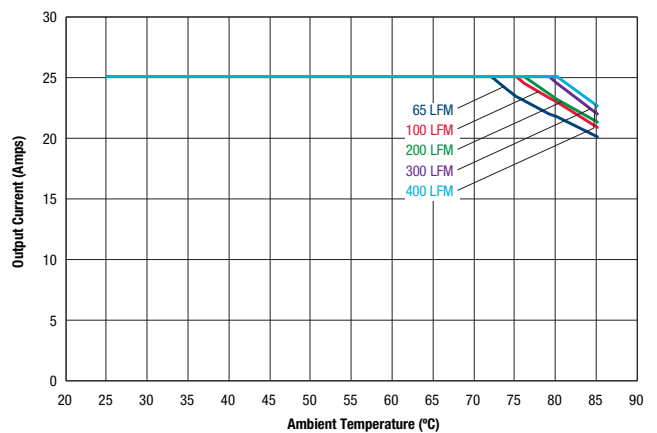

Maximum Current Temperature Derating at Sea Level (Vin=12V, Vout=1.0V)

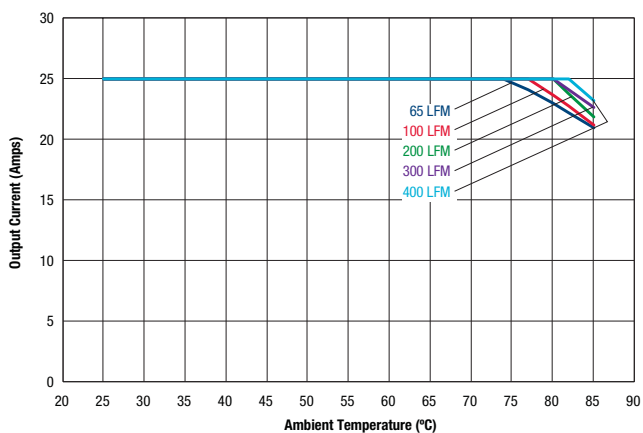

Maximum Current Temperature Derating at Sea Level (Vin=12V, Vout=0.6V)

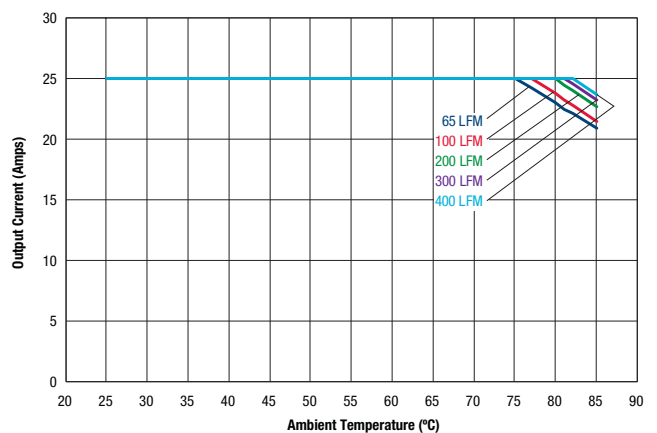

**TYPICAL PERFORMANCE DATA**

Remote On/Off Start up (Vin=12Vout, Iout=25A, Vout=3.3V, Cout=100µf, Ta=+25°C)  
Ch1=Enable, Ch2=PowGood, Ch3=Vout

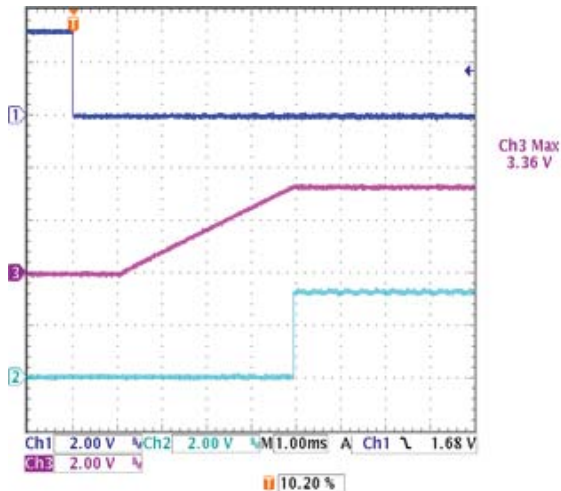

Remote On/Off Start up (Vin=12Vout, Iout=0A, Vout=3.3Vout, Cout=100µf, Ta=+25°C)  
Ch1=Enable, Ch2=PowGood, Ch3=Vout

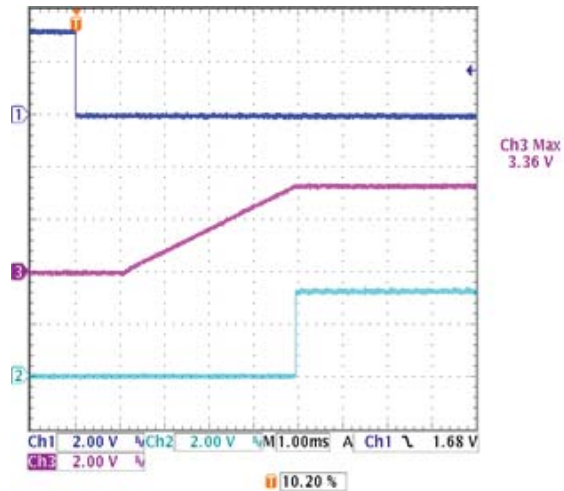

Remote On/Off Start up (Vin=12Vout, Iout=25A, Vout=0.6V, Cout=100µf, Ta=+25°C)  
Ch1=Enable, Ch2=PowGood, Ch3=Vout

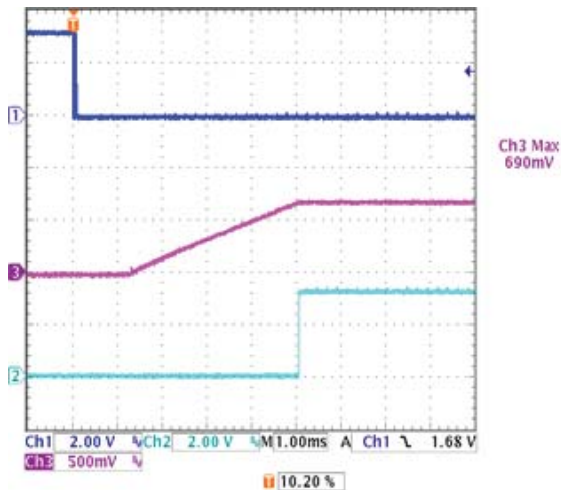

Remote On/Off Start up (Vin=12Vout, Iout=0A, Vout=0.6V, Cout=100µf, Ta=+25°C)  
Ch1=Enable, Ch2=PowGood, Ch3=Vout

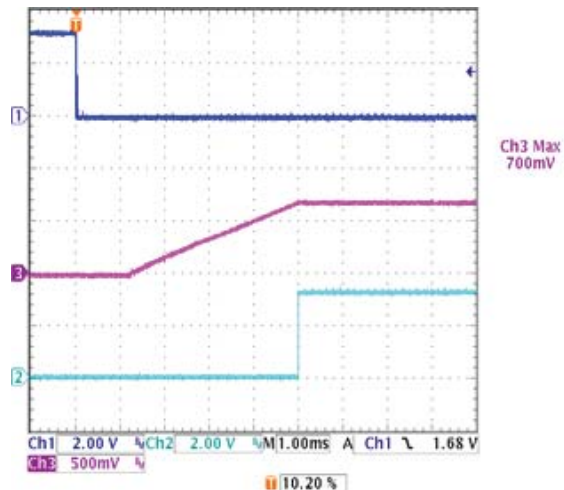

**TYPICAL PERFORMANCE DATA**

Start up Delay (Vin=12V, Vout=3.3V, Iout=25A, Cload=100µf, T+25°C)  
Ch1=Vin, Ch3=Vout

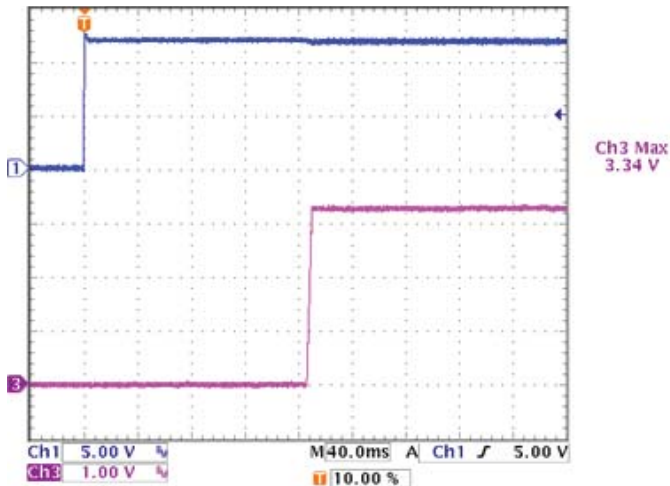

Start up Delay (Vin=12V, Vout=3.3V, Iout=0A, Cload=100µf, T+25°C)  
Ch1=Vin, Ch3=Vout

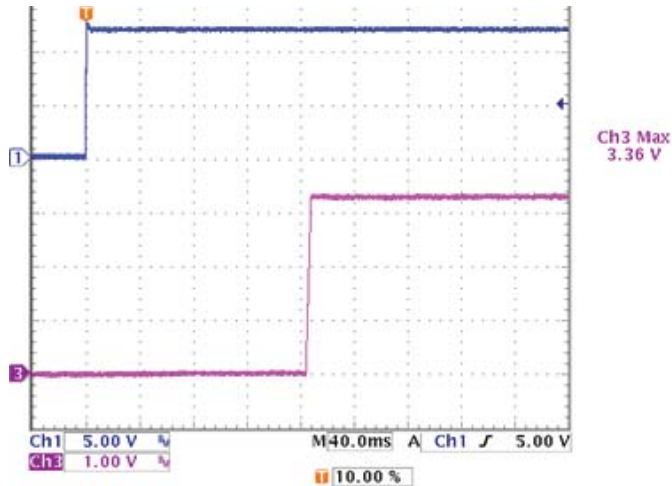

Start up Delay (Vin=12V, Vout=0.6V, Iout=25A, Cload=100µf, T+25°C)  
Ch1=Vin, Ch3=Vout

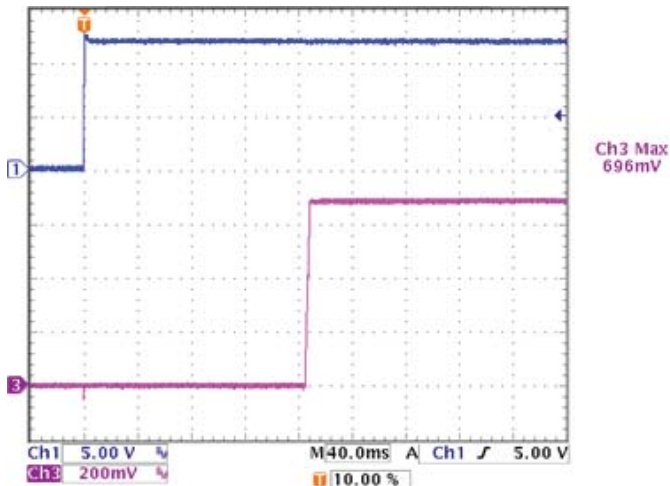

Start up Delay (Vin=12V, Vout=0.6V, Iout=0A, Cload=100µf, T+25°C)  
Ch1=Vin, Ch3=Vout

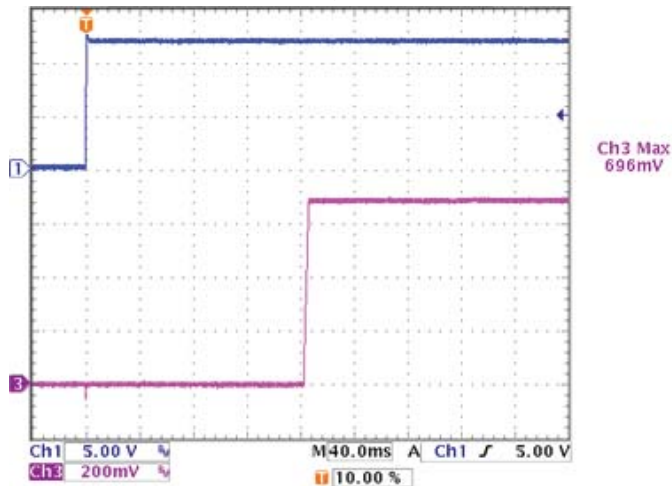



**TYPICAL PERFORMANCE DATA**

Step Load Transient Response (Vin = 12V, Vout = 3.3V, Cloud = 100µf, Iout = 0% to 50% of full load, Ta = +25°C) Ch1 = Vout, Ch3 = Iout

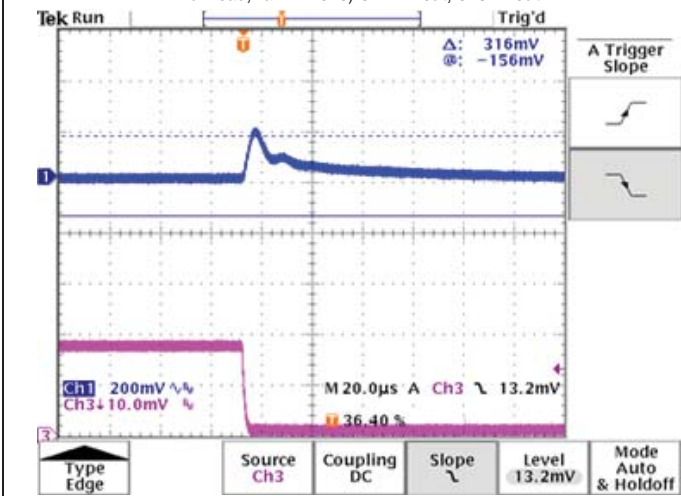

Step Load Transient Response (Vin = 12V, Vout = 3.3V, Cloud = 100µf, Iout = 50% to 0% of full load, Ta = +25°C) Ch1 = Vout, Ch3 = Iout

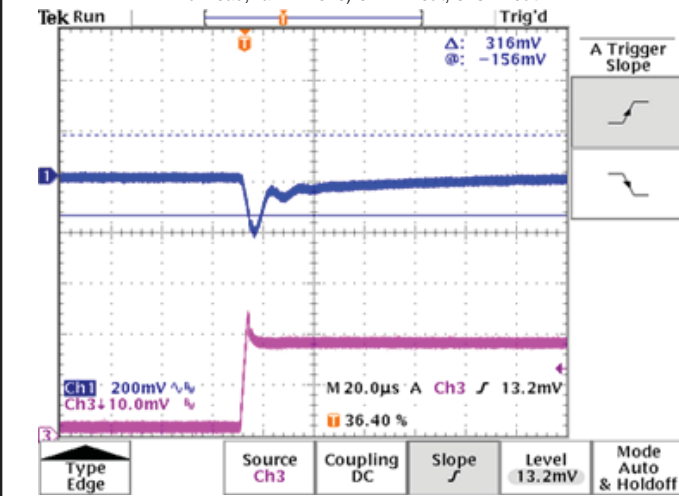

Step Load Transient Response (Vin = 12V, Vout = 3.3V, Cloud = 1000µf, Iout = 0% to 50% of full load, Ta = +25°C) Ch1 = Vout, Ch3 = Iout

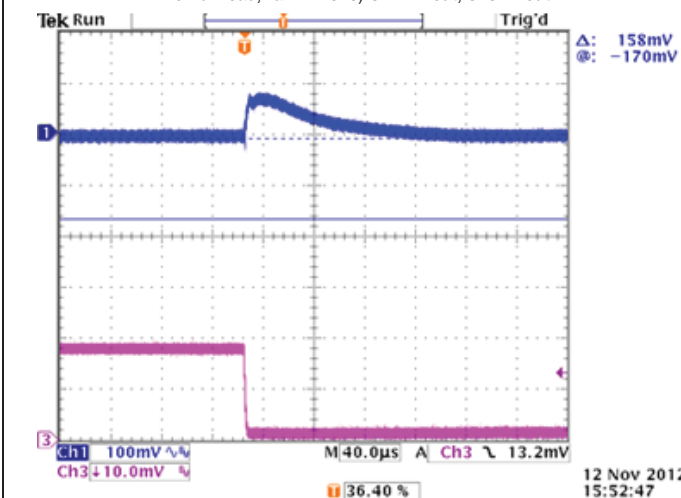

Step Load Transient Response (Vin = 12V, Vout = 3.3V, Cloud = 1000µf, Iout = 50% to 0% of full load, Ta = +25°C) Ch1 = Vout, Ch3 = Iout

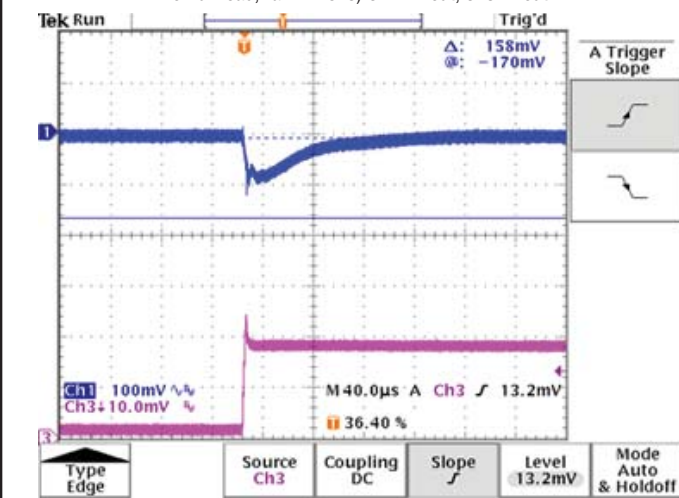

Step Load Transient Response (Vin = 12V, Vout = 3.3V, Cloud = 3000µf, Iout = 0% to 50% of full load, Ta = +25°C) Ch1 = Vout, Ch3 = Iout

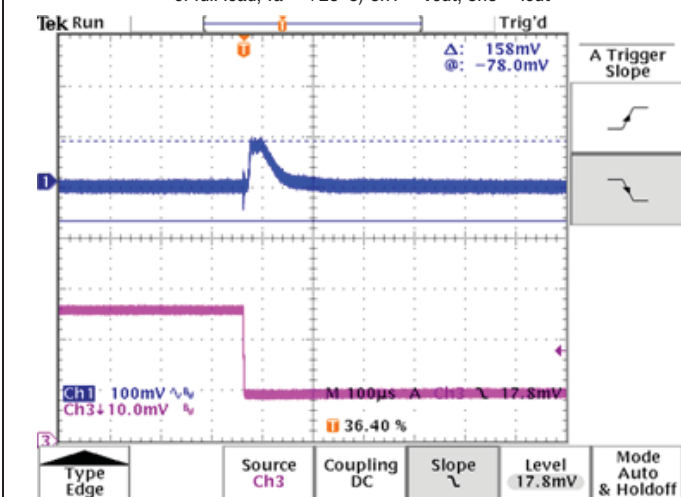

Step Load Transient Response (Vin = 12V, Vout = 3.3V, Cloud = 3000µf, Iout = 50% to 0% of full load, Ta = +25°C) Ch1 = Vout, Ch3 = Iout

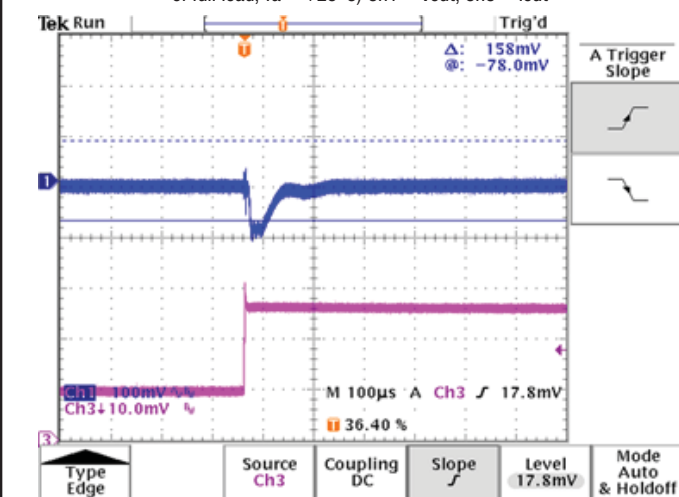

**TYPICAL PERFORMANCE DATA**

Step Load Transient Response ( $V_{in} = 12V, V_{out} = 0.6V, \text{Cloud} = 100\mu\text{f}, I_{out} = 50\% \text{ to } 0\% \text{ of full load}, T_a = +25^\circ\text{C}$ ) Ch1 = Vout, Ch3 = Iout

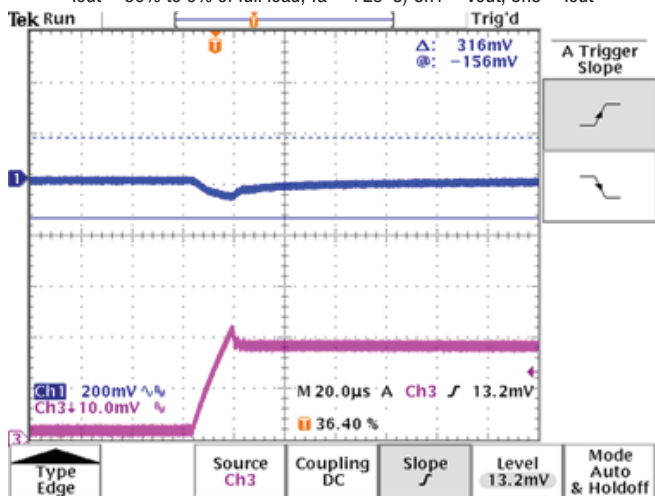

Step Load Transient Response ( $V_{in} = 12V, V_{out} = 0.6V, \text{Cloud} = 100\mu\text{f}, I_{out} = 0\% \text{ to } 50\% \text{ of full load}, T_a = +25^\circ\text{C}$ ) Ch1 = Vout, Ch3 = Iout

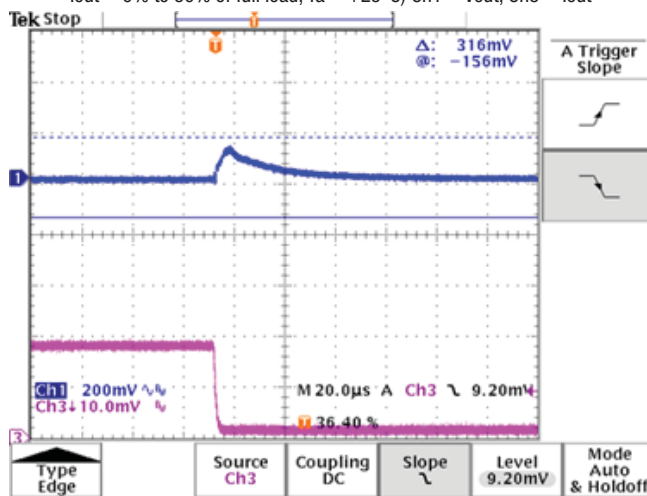

Step Load Transient Response ( $V_{in} = 12V, V_{out} = 0.6V, \text{Cloud} = 1000\mu\text{f}, I_{out} = 50\% \text{ to } 0\% \text{ of full load}, T_a = +25^\circ\text{C}$ ) Ch1 = Vout, Ch3 = Iout

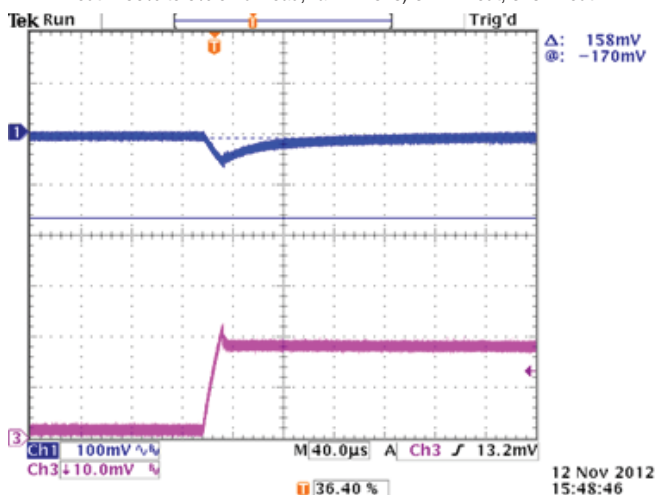

Step Load Transient Response ( $V_{in} = 12V, V_{out} = 0.6V, \text{Cloud} = 1000\mu\text{f}, I_{out} = 0\% \text{ to } 50\% \text{ of full load}, T_a = +25^\circ\text{C}$ ) Ch1 = Vout, Ch3 = Iout

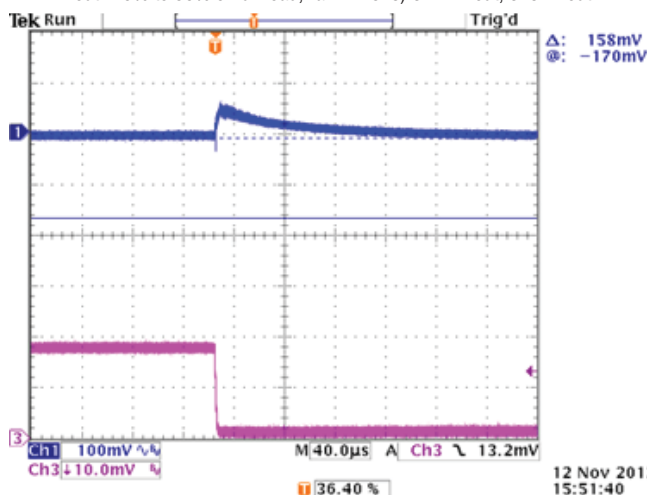

Step Load Transient Response ( $V_{in} = 12V, V_{out} = 0.6V, \text{Cloud} = 3000\mu\text{f}, I_{out} = 50\% \text{ to } 0\% \text{ of full load}, T_a = +25^\circ\text{C}$ ) Ch1 = Vout, Ch3 = Iout

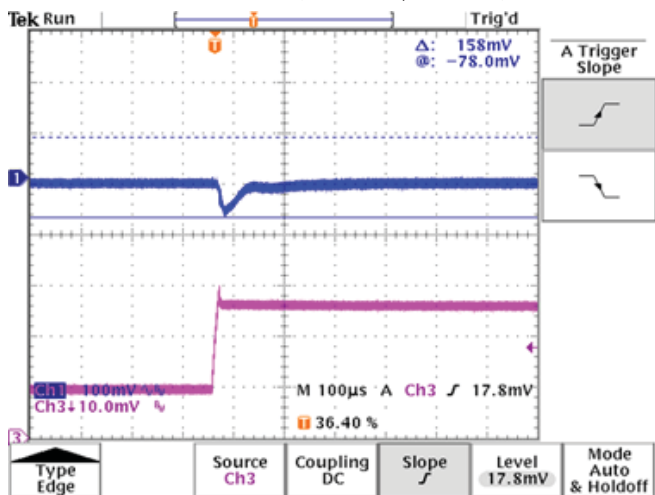

Step Load Transient Response ( $V_{in} = 12V, V_{out} = 0.6V, \text{Cloud} = 3000\mu\text{f}, I_{out} = 0\% \text{ to } 50\% \text{ of full load}, T_a = +25^\circ\text{C}$ ) Ch1 = Vout, Ch3 = Iout

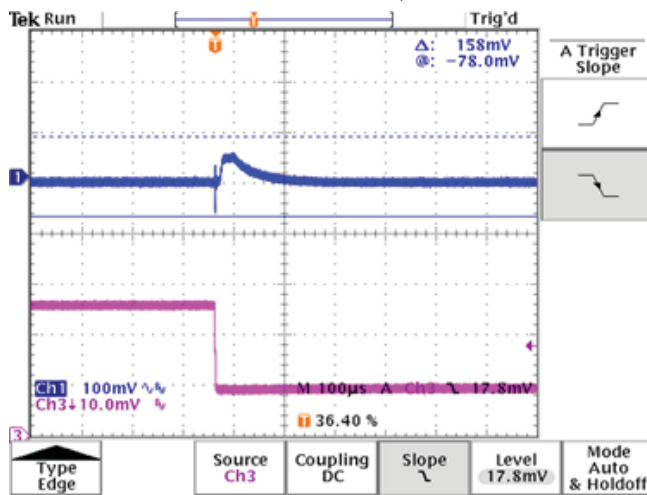

**TYPICAL PERFORMANCE DATA**

Output Ripple and Noise (Vin=12V, Vout=3.3V, Iout=25A, Cout=1µf, Ta=+25°C) Ch3=Vout

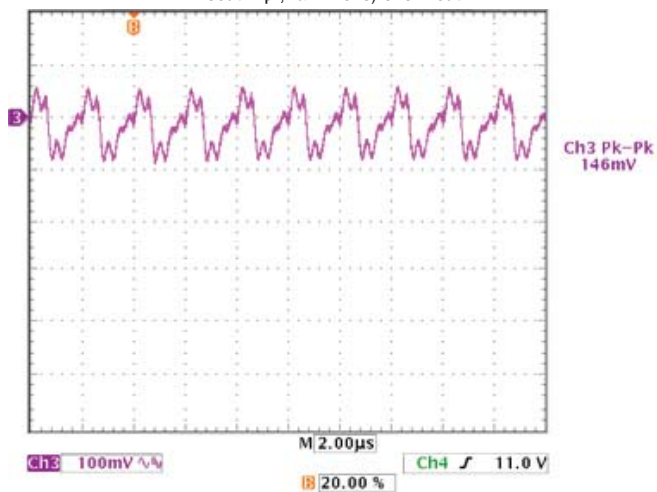

Output Ripple and Noise (Vin=12V, Vout=3.3V, Iout=0A, Cout=1µf, Ta=+25°C) Ch3=Vout

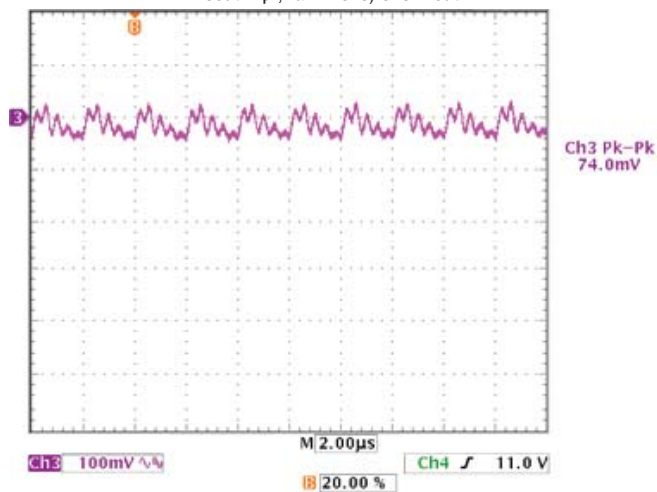

Output Ripple and Noise (Vin=12V, Vout=0.6V, Iout=25A, Cout=1µf, Ta=+25°C) Ch3=Vout

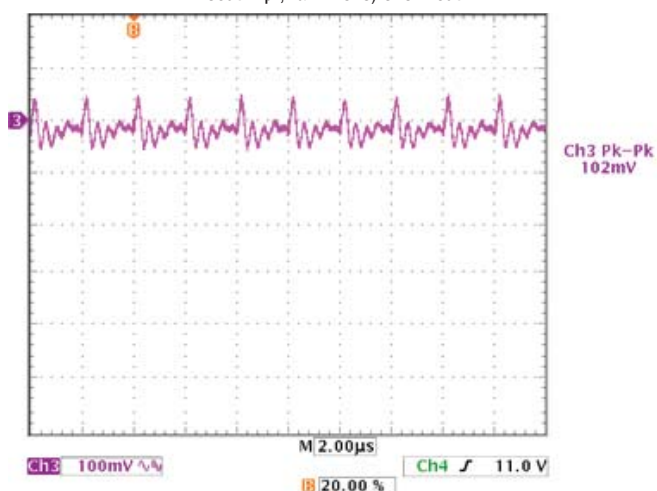

Output Ripple and Noise (Vin=12V, Vout=0.6V, Iout=0A, Cout=1µf, Ta=+25°C) Ch3=Vout

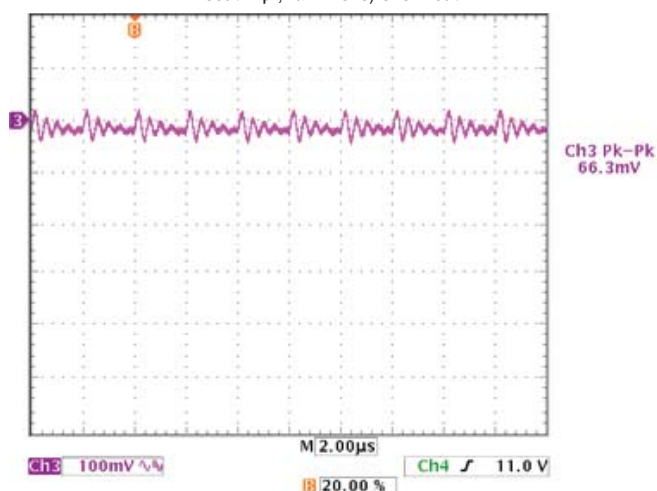

Output Ripple and Noise (Vin=12V, Vout=3.3V, Iout=25A, Cout=100µf, Ta=+25°C) Ch3=Vout

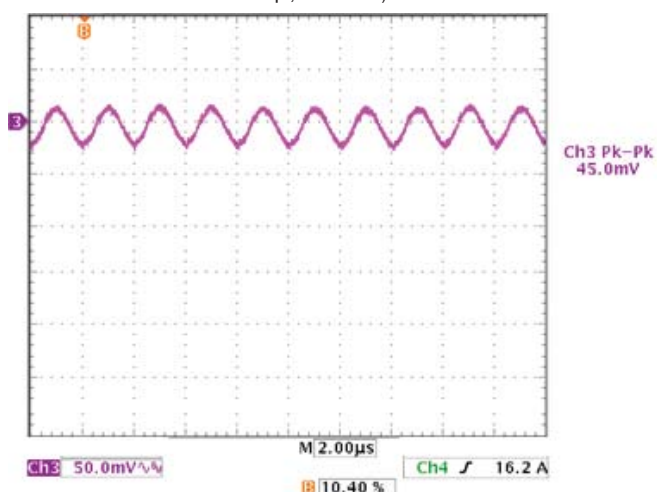

Output Ripple and Noise (Vin=12V, Vout=3.3V, Iout=0A, Cout=100µf, Ta=+25°C) Ch3=Vout

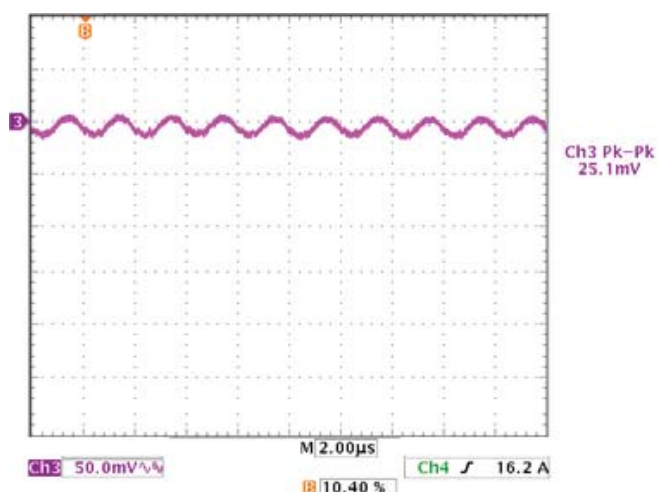

**MECHANICAL SPECIFICATIONS (MSL Rating 2)**

PIN #1 END INDICATOR

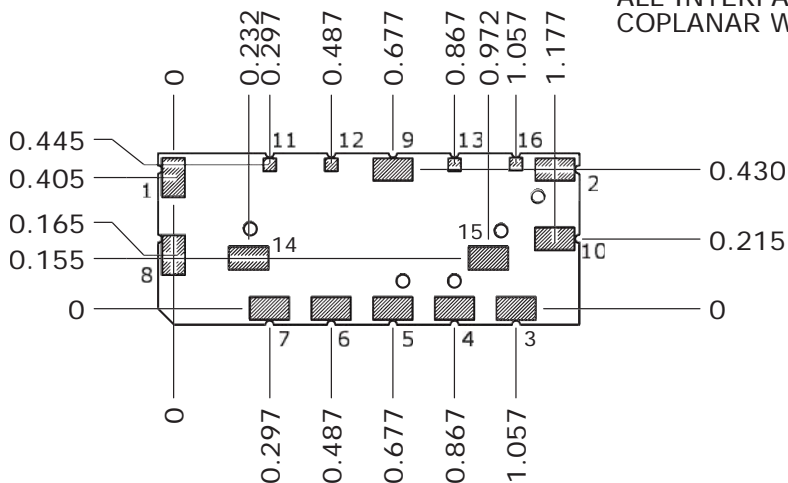
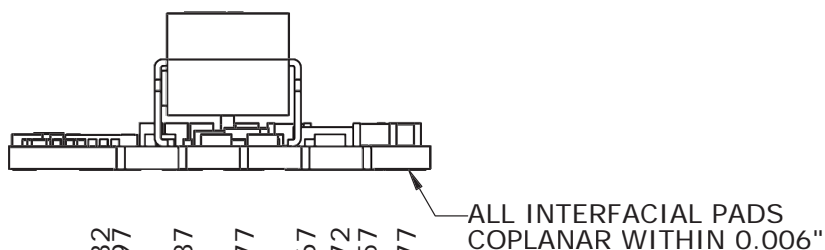
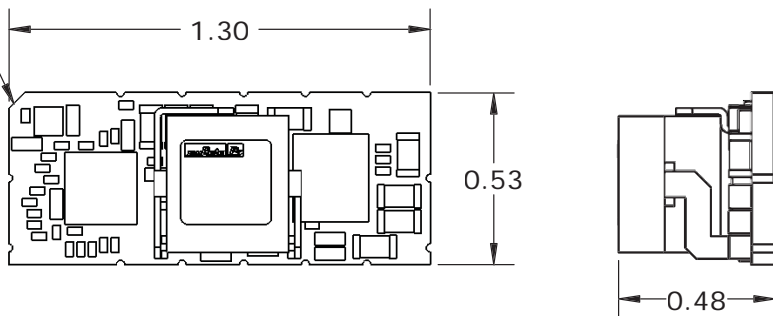

DIMENSIONS ARE IN INCHES [mm]

TOLERANCES:  
 2 PLACE  $\pm 0.02$       ANGLES:  $\pm 1^\circ$   
 3 PLACE  $\pm 0.010$

COMPONENTS SHOWN ARE FOR REFERENCE ONLY

MATERIAL:  
 PINS: COPPER ALLOY

FINISH: (ALL PINS)  
 GOLD (5u"MIN) OVER NICKEL (50u" MIN)

**INPUT/OUTPUT CONNECTIONS**

Pin	Function
1	On/Off
2	Vin
3	N/C
4	Ground
5	Vout
6	Trim
7	+Sense
8	-Sense
9	PG (PowerGood)
10	Sync
14	Gnd
15	Gnd
16	Gnd

Dimensions are in inches (mm shown for ref. only).

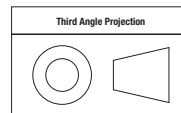

Tolerances (unless otherwise specified):  
 .XX  $\pm 0.02$  (0.5)  
 .XXX  $\pm 0.010$  (0.25)  
 Angles  $\pm 1^\circ$

Components are shown for reference only.

**RECOMMENDED FOOTPRINT**

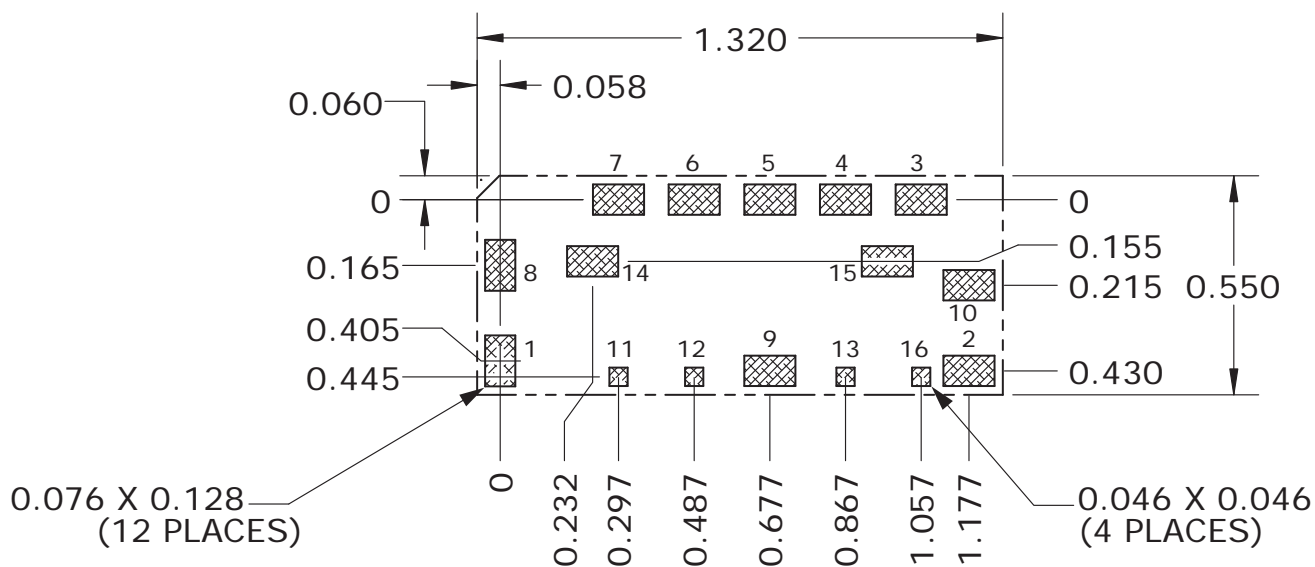

**TAPE AND REEL (MSL Rating 2)**

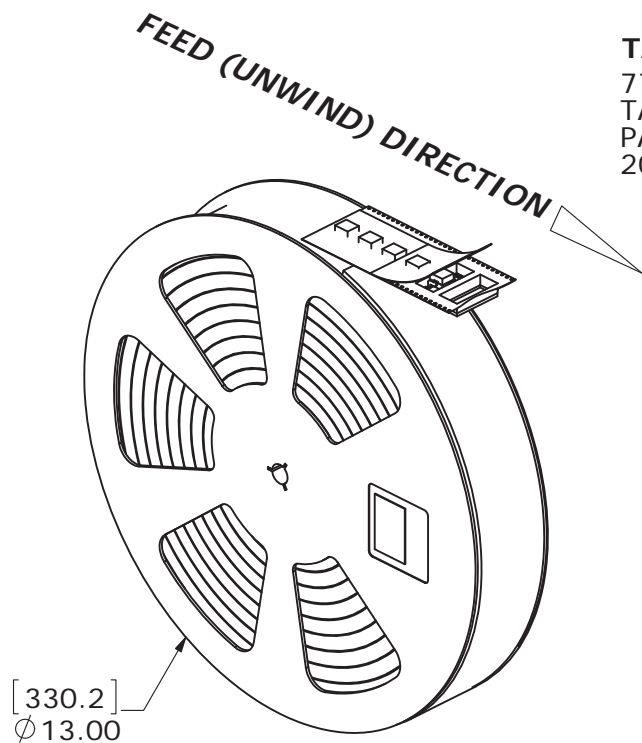

**TAPE AND REEL**  
7770233 SHIPPING KIT  
TAPE AND REEL WITH MSL2  
PACKAGING (NOT SHOWN)  
200 UNITS PER REEL

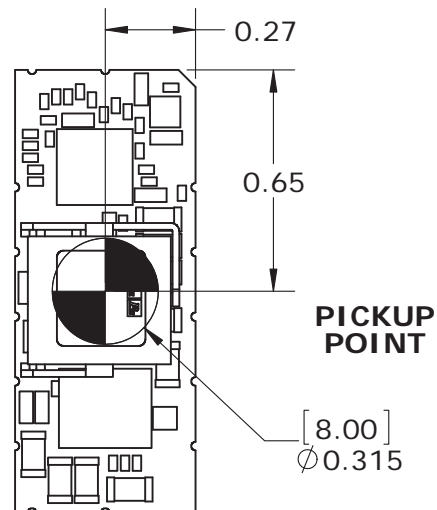

**FEED (UNWIND) DIRECTION**

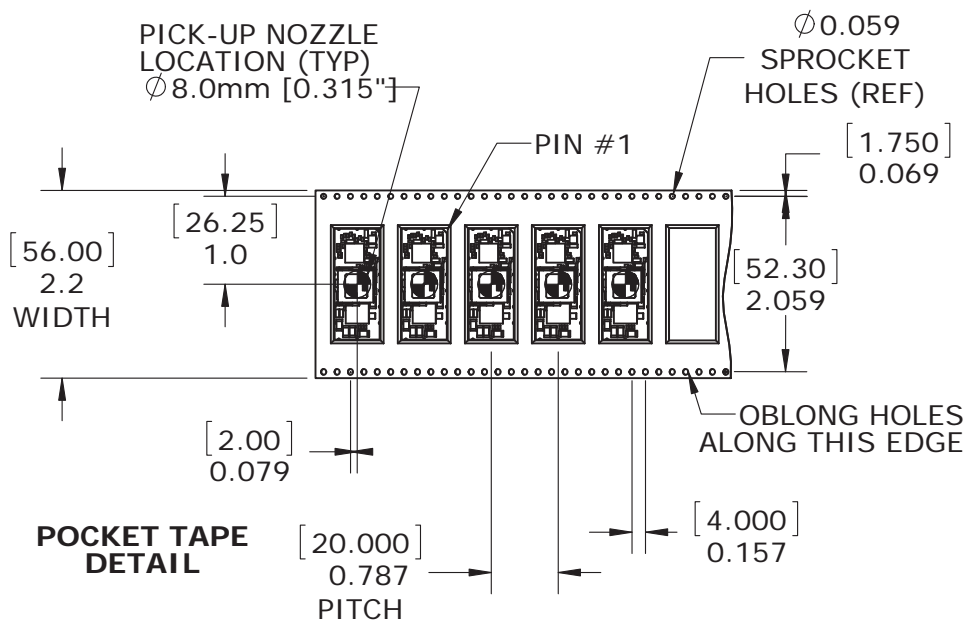

### TECHNICAL NOTES

#### Output Voltage Adjustment

The output voltage may be adjusted over a limited range by connecting an external trim resistor (Rtrim) between the Trim pin and Ground. The Rtrim is recommended to have a  $\pm 0.5\%$  accuracy (or better) with low temperature coefficient,  $\pm 100$  ppm/ $^{\circ}\text{C}$  or better. Mount the resistor close to the converter with very short leads or use a surface mount trim resistor.

In the tables below, the calculated resistance is given. Do not exceed the specified limits of the output voltage or the converter's maximum power rating when applying these resistors. Also, avoid high noise at the Trim input. However, to prevent instability, you should never connect any capacitors to Trim.

#### OKLF-T/25-W12N

Output Voltage	Calculated Rtrim (k $\Omega$ )
0.600 V	0 k $\Omega$
0.700 V	11.5 k $\Omega$
0.750 V	18.2 k $\Omega$
0.800 V	24.9 k $\Omega$
0.850 V	31.6 k $\Omega$
0.900 V	38.3 k $\Omega$
0.950 V	45.3 k $\Omega$
1.000 V	52.3 k $\Omega$
1.050 V	59.0 k $\Omega$
1.100 V	66.5 k $\Omega$
1.200 V	73.2 k $\Omega$
1.500 V	80.6 k $\Omega$
1.800 V	86.6 k $\Omega$
2.500 V	93.1 k $\Omega$
3.300 V	100 k $\Omega$

#### Input Fusing

Certain applications and/or safety agencies may require fuses at the inputs of power conversion components. Fuses should also be used when there is the possibility of sustained input voltage reversal which is not current-limited. For greatest safety, we recommend a fast blow fuse installed in the ungrounded input supply line.

The installer must observe all relevant safety standards and regulations. For safety agency approvals, install the converter in compliance with the end-user safety standard.

#### Input Under-Voltage Shutdown and Start-Up Threshold

Under normal start-up conditions, converters will not begin to regulate properly until the ramping-up input voltage exceeds and remains at the Start-Up Threshold Voltage (see Specifications). Once operating, converters will not turn off until the input voltage drops below the Under-Voltage Shutdown Limit. Subsequent restart will not occur until the input voltage rises again above the Start-Up Threshold. This built-in hysteresis prevents any unstable on/off operation at a single input voltage.

Users should be aware however of input sources near the Under-Voltage Shutdown whose voltage decays as input current is consumed (such as

capacitor inputs), the converter shuts off and then restarts as the external capacitor recharges. Such situations could oscillate. To prevent this, make sure the operating input voltage is well above the UV Shutdown voltage AT ALL TIMES.

#### Start-Up Time

Assuming that the output current is set at the rated maximum, the Vin to Vout Start-Up Time (see Specifications) is the time interval between the point when the ramping input voltage crosses the Start-Up Threshold and the fully loaded regulated output voltage enters and remains within its specified accuracy band. Actual measured times will vary with input source impedance, external input capacitance, input voltage slew rate and final value of the input voltage as it appears at the converter.

These converters include a soft start circuit to moderate the duty cycle of its PWM controller at power up, thereby limiting the input inrush current.

The On/Off Remote Control interval from On command to Vout regulated assumes that the converter already has its input voltage stabilized above the Start-Up Threshold before the On command. The interval is measured from the On command until the output enters and remains within its specified accuracy band. The specification assumes that the output is fully loaded at maximum rated current. Similar conditions apply to the On to Vout regulated specification such as external load capacitance and soft start circuitry.

#### Recommended Input Filtering

The user must assure that the input source has low AC impedance to provide dynamic stability and that the input supply has little or no inductive content, including long distributed wiring to a remote power supply. The converter will operate with no additional external capacitance if these conditions are met.

For best performance, we recommend installing a low-ESR capacitor immediately adjacent to the converter's input terminals. The capacitor should be a ceramic type such as the Murata Power Solutions GRM32 series or a polymer type. Initial suggested capacitor values are 10 to 22  $\mu\text{F}$ , rated at twice the expected maximum input voltage. Make sure that the input terminals do not go below the undervoltage shutdown voltage at all times. More input bulk capacitance may be added in parallel (either electrolytic or tantalum) if needed.

#### Recommended Output Filtering

The converter will achieve its rated output ripple and noise with no additional external capacitor. However, the user may install more external output capacitance to reduce the ripple even further or for improved dynamic response. Again, use low-ESR ceramic (Murata Power Solutions GRM32 series) or polymer capacitors. Initial values of 10 to 47  $\mu\text{F}$  may be tried, either single or multiple capacitors in parallel. Mount these close to the converter. Measure the output ripple under your load conditions.

Use only as much capacitance as required to achieve your ripple and noise objectives. Excessive capacitance can make step load recovery sluggish or possibly introduce instability. Do not exceed the maximum rated output capacitance listed in the specifications.

**Input Ripple Current and Output Noise**

All models in this converter series are tested and specified for input reflected ripple current and output noise using designated external input/output components, circuits and layout as shown in the figures below. The Cbus and Lbus components simulate a typical DC voltage bus. Please note that the values of Cin, Lbus and Cbus will vary according to the specific converter model. I

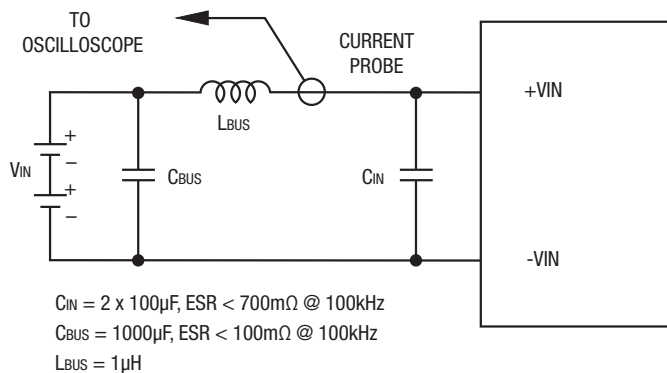

Figure 3. Measuring Input Ripple Current

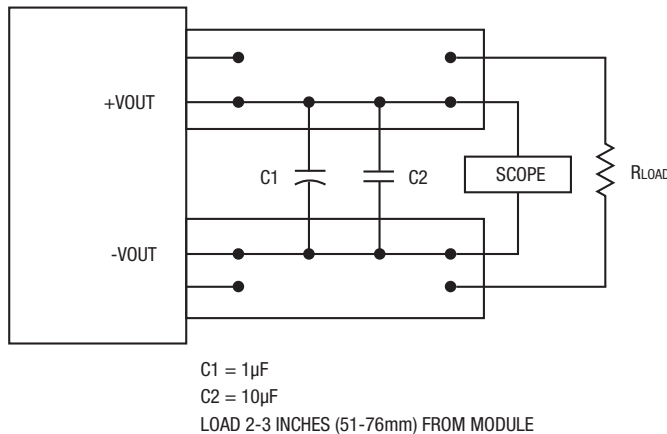

Figure 4. Measuring Output Ripple and Noise (PARD)

**Minimum Output Loading Requirements**

All models regulate within specification and are stable under no load to full load conditions. Operation under no load might however slightly increase output ripple and noise.

**Thermal Shutdown**

To prevent many over temperature problems and damage, these converters include thermal shutdown circuitry. If environmental conditions cause the temperature of the DC/DC's to rise above the Operating Temperature Range up to the shutdown temperature, an on-board electronic temperature sensor will power down the unit. When the temperature decreases below the turn-on threshold, the converter will automatically restart. There is a small amount of hysteresis to prevent rapid on/off cycling.

**CAUTION:** If you operate too close to the thermal limits, the converter may shut down suddenly without warning. Be sure to thoroughly test your application to avoid unplanned thermal shutdown.

**Temperature Derating Curves**

The graphs in this data sheet illustrate typical operation under a variety of conditions. The Derating curves show the maximum continuous ambient air temperature and decreasing maximum output current which is acceptable under increasing forced airflow measured in Linear Feet per Minute (“LFM”). Note that these are AVERAGE measurements. The converter will accept brief increases in current or reduced airflow as long as the average is not exceeded.

Note that the temperatures are of the ambient airflow, not the converter itself which is obviously running at higher temperature than the outside air. Also note that very low flow rates (below about 25 LFM) are similar to “natural convection,” that is, not using fan-forced airflow.

Murata Power Solutions makes Characterization measurements in a closed cycle wind tunnel with calibrated airflow. We use both thermocouples and an infrared camera system to observe thermal performance.

**CAUTION:** These graphs are all collected at slightly above Sea Level altitude. Be sure to reduce the derating for higher density altitude.

**Output Current Limiting**

Current limiting inception is defined as the point at which full power falls below the rated tolerance. See the Performance/Functional Specifications. Note particularly that the output current may briefly rise above its rated value in normal operation as long as the average output power is not exceeded. This enhances reliability and continued operation of your application. If the output current is too high, the converter will enter the short circuit condition.

**Output Short Circuit Condition**

When a converter is in current-limit mode, the output voltage will drop as the output current demand increases. If the output voltage drops too low (approximately 98% of nominal output voltage for most models), the magnetically coupled voltage used to develop primary side voltages will also drop, thereby shutting down the PWM controller. Following a time-out period, the PWM will restart, causing the output voltage to begin ramping up to its appropriate value. If the short-circuit condition persists, another shutdown cycle will initiate. This rapid on/off cycling is called “hiccup mode.” The hiccup cycling reduces the average output current, thereby preventing excessive internal temperatures and/or component damage. A short circuit can be tolerated indefinitely.

The “hiccup” system differs from older latching short circuit systems because you do not have to power down the converter to make it restart. The system will automatically restore operation as soon as the short circuit condition is removed.

**On/Off Control Pin**

The On/Off Control may be driven with external logic or by applying appropriate external voltages, which are referenced to -Input Common. The On/Off Control Input should use either an open collector/open drain transistor or logic gate that does not exceed +VIN.



**Power Good**

The Power Good output is TRUE at any time the output is within approximately ±10% of the voltage set point. Power Good basically indicates whether the converter is in regulation.

It is an Open-drain Power Good output that may be wired and connected with other devices. An external pull up resistor is needed.

**Sync**

Sync is used for frequency synchronization and phase alignment between devices. An external pull up resistor is needed. Synchronization provides a method where multiple slave devices are controlled by a single master device via open loop phase alignment of the PWM patterns.

**Output Capacitive Load**

These converters do not require external capacitance added to achieve rated specifications. Users should only consider adding capacitance to reduce switching noise and/or to handle spike current load steps. Install only enough capacitance to achieve noise objectives. Excess external capacitance may cause regulation problems, degraded transient response and possible oscillation or instability.

**Soldering Guidelines**

Murata Power Solutions recommends the specifications below when installing these converters. These specifications vary depending on the solder type. Exceeding these specifications may cause damage to the product. Your production environment may differ therefore please thoroughly review these guidelines with your process engineers.

Reflow Solder Operations for surface-mount products (SMT)	
<b>For Sn/Ag/Cu based solders:</b>	
Preheat Temperature	Less than 1 °C. per second
Time over Liquidus	45 to 75 seconds
Maximum Peak Temperature	260 °C.
Cooling Rate	Less than 3 °C. per second
<b>For Sn/Pb based solders:</b>	
Preheat Temperature	Less than 1 °C. per second
Time over Liquidus	60 to 75 seconds
Maximum Peak Temperature	235 °C.
Cooling Rate	Less than 3 °C. per second

**Recommended Lead-free Solder Reflow Profile**

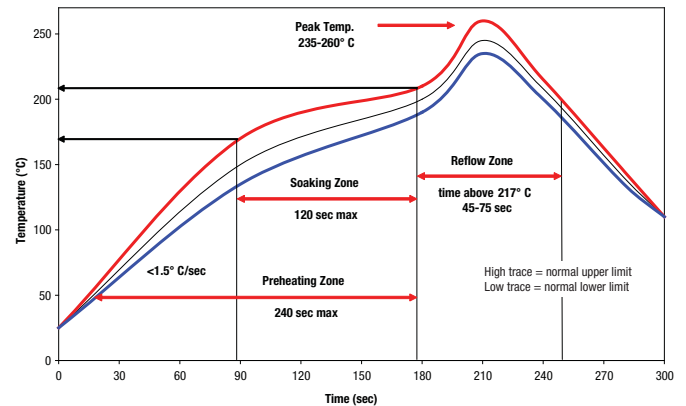

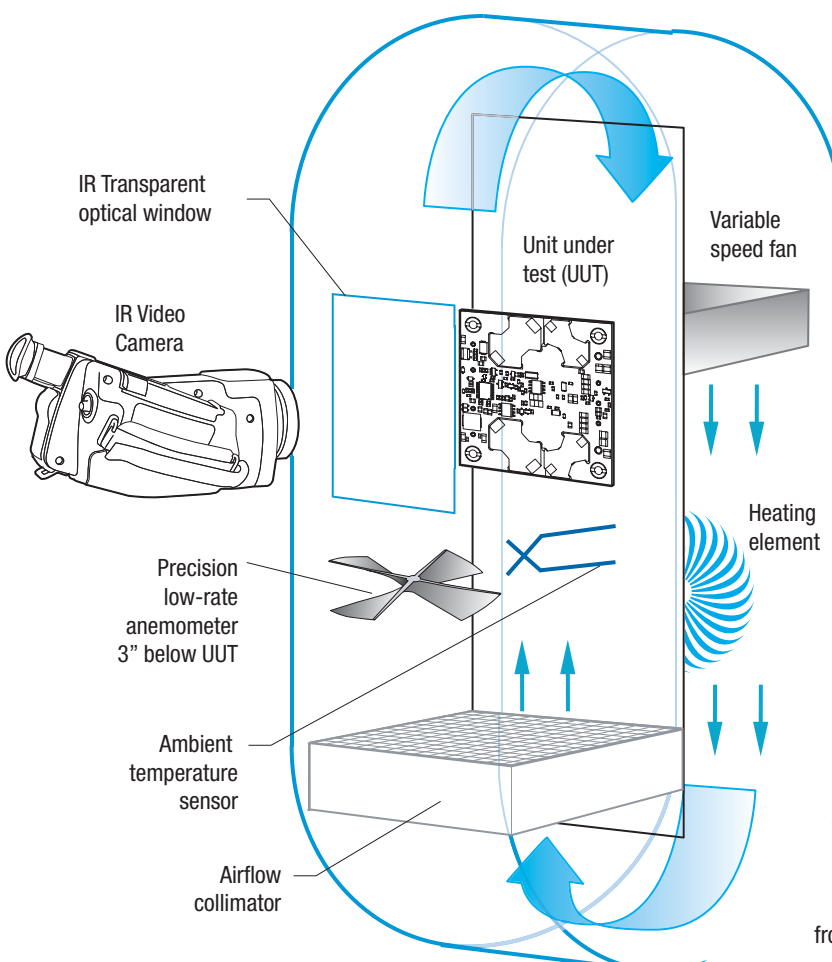

**Figure 5. Vertical Wind Tunnel**

**Vertical Wind Tunnel**

Murata Power Solutions employs a custom-designed enclosed vertical wind tunnel, infrared video camera system and test instrumentation for accurate airflow and heat dissipation analysis of power products. The system includes a precision low flow-rate anemometer, variable speed fan, power supply input and load controls, temperature gauges and adjustable heating element.

The IR camera can watch thermal characteristics of the Unit Under Test (UUT) with both dynamic loads and static steady-state conditions. A special optical port is used which is transparent to infrared wavelengths. The computer files from the IR camera can be studied for later analysis.

Both through-hole and surface mount converters are soldered down to a 10" x 10" host carrier board for realistic heat absorption and spreading. Both longitudinal and transverse airflow studies are possible by rotation of this carrier board since there are often significant differences in the heat dissipation in the two airflow directions. The combination of both adjustable airflow, adjustable ambient heat and adjustable Input/Output currents and voltages mean that a very wide range of measurement conditions can be studied.

The airflow collimator mixes the heat from the heating element to make uniform temperature distribution. The collimator also reduces the amount of turbulence adjacent to the UUT by restoring laminar airflow. Such turbulence can change the effective heat transfer characteristics and give false readings. Excess turbulence removes more heat from some surfaces and less heat from others, possibly causing uneven overheating.

Both sides of the UUT are studied since there are different thermal gradients on each side. The adjustable heating element and fan, built-in temperature gauges and no-contact IR camera mean that power supplies are tested in real-world conditions.

