

HDC 10B TSS 1M32 WMP

Weidmüller Interface GmbH & Co. KG

Klingenbergstraße 26
D-32758 Detmold
Germany

www.weidmueller.com

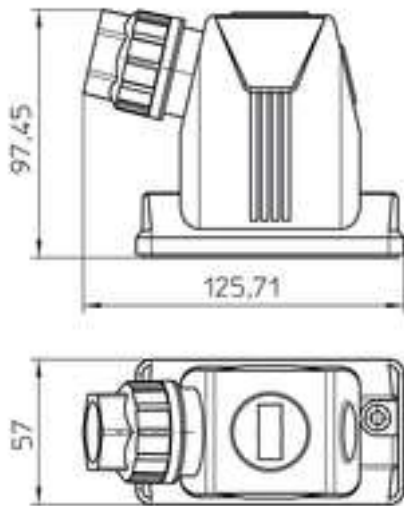

Our flange-mounted housings made of plastic have a built-in cable gland and a screw interlock. They seal directly onto the panel wall and can therefore be used without an attachment housing. The housings are impressive with their low weight and optimal protection against contamination, water and vibrations.

General ordering data

Version	HDC enclosures, Size: 4, Protection degree: IP66 (in plugged condition), IP67 plugged, Cable entry from side, Screw, , Size of cable entries: M 32
Order No.	2716760000
Type	HDC 10B TSS 1M32 WMP
GTIN (EAN)	4050118807134
Qty.	1 pc(s).

HDC 10B TSS 1M32 WMP

Weidmüller Interface GmbH & Co. KG
 Klingenbergstraße 26
 D-32758 Detmold
 Germany

www.weidmueller.com

Technical data

Dimensions and weights

Net weight	149 g
------------	-------

Cable Gland WMP

Cable diameter, min.	11 mm	Cable diameter, max.	21 mm
AF size	30 mm	Size of cable entries	M 32

Dimensions

Cable entry	w. cable glands
-------------	-----------------

General data

EMC housings	No	Housing main material	PA
Material of locking element	Stainless steel, rust-proof	Protection degree	IP66 (in plugged condition), IP67 plugged
Tightening torque	3 Nm	UL 94 flammability rating	V-0

Version

BG	4	Cable entry	w. cable glands
Colour (RAL)	RAL 9011	Design of housing	Cable entry from side
Design of locking system	Screw	Number of cable entry sideways	1
Number of cable glands	1	Sealing	NBR
Size	4	Size of cable entries	M 32
Suitable for ModuPlug®	Yes	Tightening torque	3 Nm
Top part/bottom part/lid	upper part		

Classifications

ETIM 6.0	EC000437	ETIM 7.0	EC000437
ETIM 8.0	EC000437	ECLASS 9.0	27-44-02-02
ECLASS 9.1	27-44-02-02	ECLASS 10.0	27-44-02-02
ECLASS 11.0	27-44-02-02	ECLASS 12.0	27-44-02-02

Approvals

ROHS	Conform
------	---------

Downloads

Approval/Certificate/Document of Conformity	Manufacturer's declaration
Engineering Data	CAD data – STEP
Catalogues	Catalogues in PDF-format

HDC 10B TSS 1M32 WMP

Weidmüller Interface GmbH & Co. KG
Klingenbergstraße 26
D-32758 Detmold
Germany

Drawings

www.weidmueller.com

