

# Dropper Type System Regulator ICs [Surface-mount 2-output] **SPF3006**

## Features

- Dual input and dual output (ch1: 5V/0.4A, ch2: 5V/0.2A)
- Power on reset function
- Watchdog timer
- Built-in drooping type overcurrent and thermal protection circuits (ch1)

## Absolute Maximum Ratings

(Ta=25°C)

Parameter	Symbol	Ratings	Unit	Remarks
DC input voltage	V <sub>IN1</sub>	-13 to 35	V	Reverse connection 1 min max.
	V <sub>IN2</sub>			
Vo1, Vo2 output control terminal voltage	EN	-0.3 to 35	V	
Vo2 output control terminal voltage	VC	-0.3 to 35	V	
Output current	CH1	I <sub>o1</sub>	0.4	A
	CH2	I <sub>o2</sub>	0.2	A
TC terminal input voltage	TC	-0.3 to 7	V	
CK terminal input voltage	CK			
W/D/C terminal input voltage	W/D/C			
Reset terminal output voltage	RESET			
Power dissipation	P <sub>D1</sub>	18.6	W	With an infinite heatsink mounted. *1
	P <sub>D2</sub>	2.97		
Junction temperature	T <sub>J</sub>	-40 to 150	°C	
Operating temperature	T <sub>op</sub>	-40 to 105	°C	
Storage temperature	T <sub>stg</sub>	-40 to 150	°C	
Thermal resistance (junction to case)	θ <sub>J-C</sub>	6.7	°C/W	With an infinite heatsink mounted.
Thermal resistance (junction to ambient air)	θ <sub>J-A</sub>	42	°C/W	*1

Notes: \*1: With glass epoxy + copper foil board (size 5.0 × 7.4cm; t: glass epoxy = 1.6mm / copper foil = 18μm)

## Electrical Characteristics

Parameter	Symbol	Ratings			Unit	Conditions
		min	typ	max		
Input voltage	V <sub>IN1, 2</sub>	Vo1+V <sub>DIF1</sub>		35	V	*2, 3
Output voltage	CH1	Vo1	4.85	5.15	V	V <sub>IN1</sub> =6 to 18V, I <sub>o</sub> =0 to 0.3A
	CH2	Vo2	4.85	5.15	V	V <sub>IN2</sub> =6 to 18V, I <sub>o</sub> =0 to 0.3A
Dropout voltage	CH1	V <sub>DIF1</sub>		0.5	V	
	CH2	V <sub>DIF2</sub>		0.5	V	
Ripple rejection	CH1	R <sub>REJ1</sub>	54		db	f = 100 to 120Hz
	CH2	R <sub>REJ2</sub>	54		db	
Quiescent circuit current	I <sub>q</sub>		10	50	μA	V <sub>IN1</sub> =16V, V <sub>EN</sub> =0V
			50	250	μA	V <sub>IN1</sub> =35V, V <sub>EN</sub> =0V
			5	10	mA	
GND current	I <sub>GND</sub>		70	100	mA	I <sub>o1</sub> =I <sub>o2</sub> =0.2A
Overcurrent protection starting current	CH1	I <sub>s11</sub>	0.402	1.8	A	Vo1=4.5V
	CH2	I <sub>s21</sub>	0.201	0.8	A	Vo2=4.5V
Residual current at a short	CH1	I <sub>s21</sub>	0.402	1.8	A	Vo1=0V
	CH2	I <sub>s22</sub>	0.201	0.8	A	Vo2=0V
EN output control voltage	V <sub>ENth</sub>		0.9	3.5	V	
EN output control current	ON	I <sub>ENH</sub>		50	μA	EN=5V
	OFF	I <sub>ENL</sub>	-1.0	1.0	μA	EN=0V
Reset terminal LOW voltage	V <sub>rSL</sub>			0.5	V	I <sub>sink</sub> =250μA (Pull-up resistance 20kΩ typ)
Reset terminal HI voltage	V <sub>rSH</sub>	Vo1-0.8V			V	I <sub>source</sub> =15μA *4
Reset detect voltage	CH	Vo1thH		Vo1+0.97	V	V <sub>rS</sub> >4.5V
		Vo1thL	4.05		V	V <sub>rS</sub> <0.8V
Power on reset delay time	t <sub>dly</sub>	1.18 • R <sub>tc</sub> • C <sub>tc</sub>	1.26 • R <sub>tc</sub> • C <sub>tc</sub>	1.35 • R <sub>tc</sub> • C <sub>tc</sub>	S	Min. set time: 6mS
W/D time	t <sub>wd</sub>	0.93 • R <sub>tc</sub> • C <sub>tc</sub>	1.03 • R <sub>tc</sub> • C <sub>tc</sub>	1.13 • R <sub>tc</sub> • C <sub>tc</sub>	S	Min. set time: 4mS
W/D pulse time	t <sub>wdp</sub>	0.07 • R <sub>tc</sub> • C <sub>tc</sub>	0.13 • R <sub>tc</sub> • C <sub>tc</sub>	0.19 • R <sub>tc</sub> • C <sub>tc</sub>	S	Min. set time: 400μS
CK terminal control voltage	V <sub>ckth</sub>		1.0	3.0	V	Min. clock pulse time: 5μs (Duty 50%)
CK terminal control current	ON	I <sub>ckH</sub>		200	μA	V <sub>ck</sub> =5V
	OFF	I <sub>ckL</sub>	-1.0	1.0	μA	V <sub>ck</sub> =0V
V <sub>c</sub> output control voltage	V <sub>cth</sub>		1.0	3.5	V	
V <sub>c</sub> output control current	I <sub>cl</sub>			300	μA	V <sub>c</sub> =5V
			-1.0	1.0	μA	V <sub>c</sub> =0V
W/D/C terminal control voltage	V <sub>w/d/cth</sub>		1.0	3.0	V	
W/D/C terminal control current	ON	I <sub>w/d/cH</sub>		200	μA	V <sub>w/d/c</sub> =5V
	OFF	I <sub>w/d/cL</sub>	-1.0	1.0	μA	V <sub>w/d/c</sub> =0V

Notes:

- \*2: Refer to Dropout Voltage.  
 \*3: Since P<sub>D(max)</sub> = (V<sub>IN</sub>-V<sub>O1</sub>) • I<sub>o1</sub> + (V<sub>IN2</sub>-V<sub>O2</sub>) • I<sub>o2</sub> + (V<sub>IN</sub> • I<sub>q</sub>) = 22W, V<sub>IN(max)</sub>, I<sub>o1(max)</sub> and I<sub>o2(max)</sub> may be limited depending on operating conditions.  
 \*4: The RESET terminal is pulled up in the IC; may be directly connected to logic circuits.  
 \*6: The thermal protection function is built in V<sub>O1</sub> (CH1 side) only. The design thermal protection starting temperature is 151°C (min.) and 165°C (typ). These values represent the design warranty.

## External Dimensions (unit: mm)

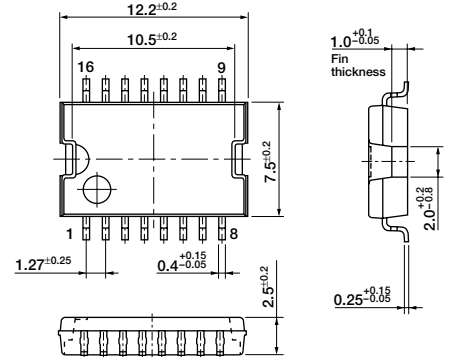

## Standard Connection Diagram

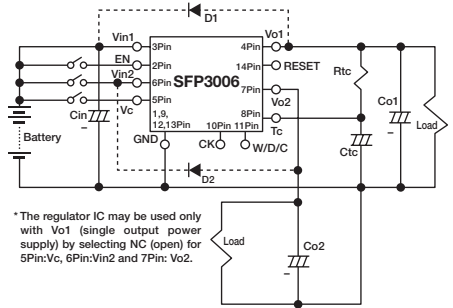

\* The regulator IC may be used only with Vo1 (single output power supply) by selecting NC (open) for 5Pin:Vc, 6Pin:Vin2 and 7Pin:Vo2.

Cin: Capacitor (39μF) for oscillation prevention  
 Co1: Output capacitor (39μF)  
 Co2: Output capacitor (39μF)  
 Tantalum capacitors are recommended particularly for low temperatures (tantalum capacitors of about 0.47μF in parallel).  
 D1, D2: Protection diodes.  
 Required for protection against reverse biasing between input and output (Recommended diode: SANKEN EU2Z).

## Circuit Block Diagram

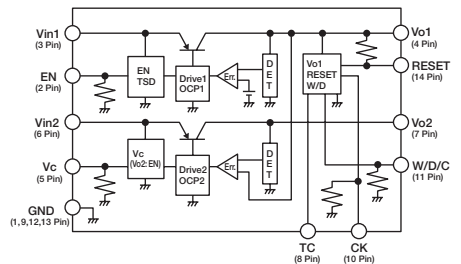

## Timing Chart

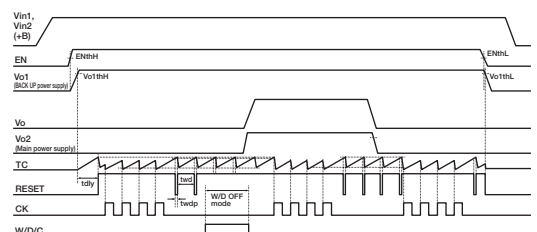

**Electrical Characteristics**

■ Rise Characteristics of Output Voltage (V<sub>O1</sub>)

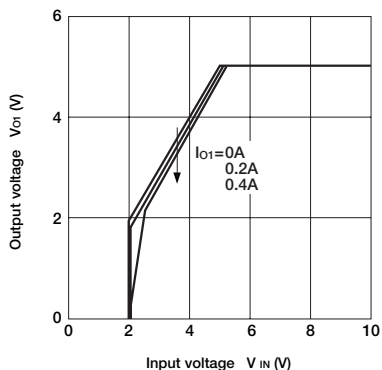

■ Rise Characteristics of Output Voltage (V<sub>O2</sub>)

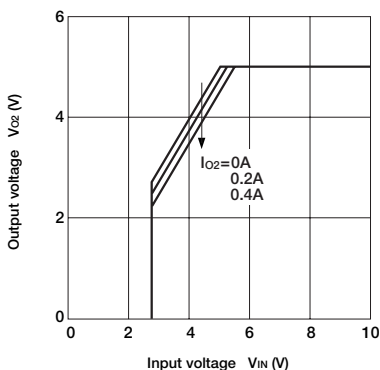

■ Line Regulation (V<sub>O1</sub>)

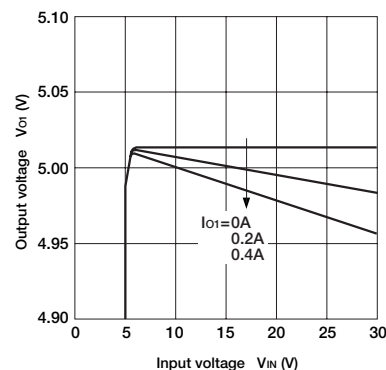

■ Line Regulation (V<sub>O2</sub>)

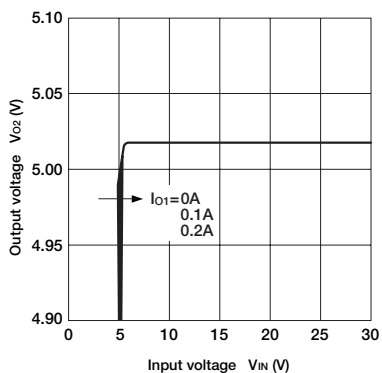

■ Load Regulation (V<sub>O1</sub>)

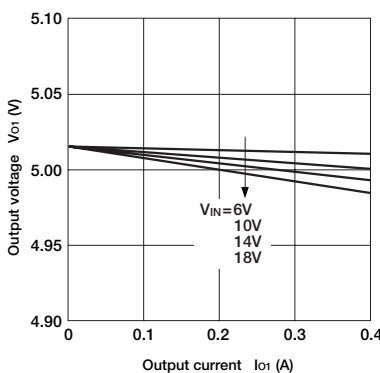

■ Load Regulation (V<sub>O2</sub>)

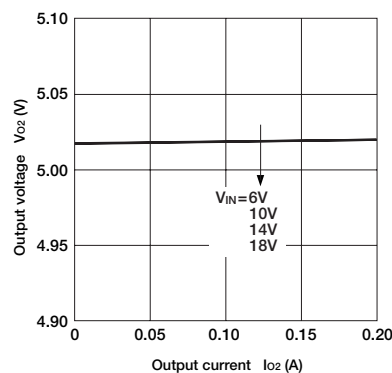

■ Dropout Voltage (V<sub>O1</sub>)

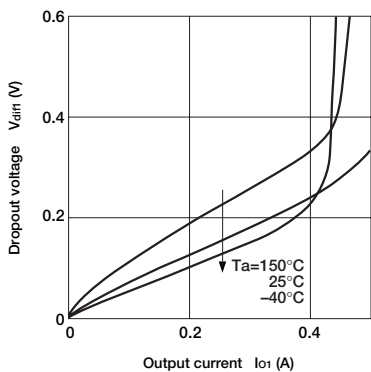

■ Dropout Voltage (V<sub>O2</sub>)

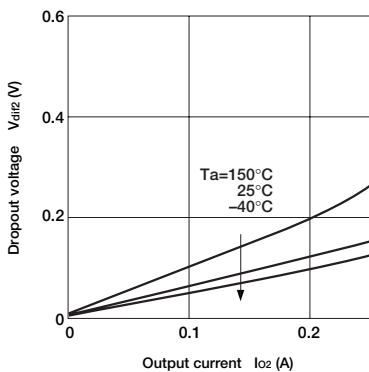

■ Overcurrent Protection Characteristics (V<sub>O1</sub>)

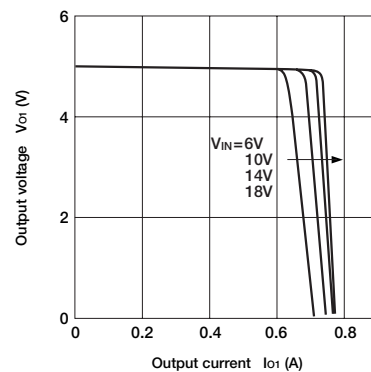

■ Overcurrent Protection Characteristics (V<sub>O2</sub>)

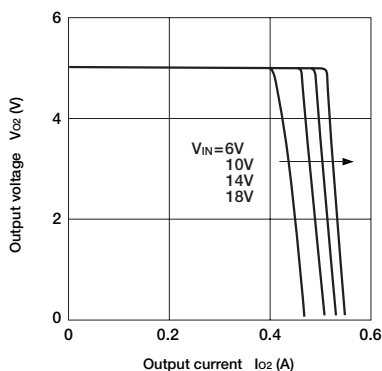

■ Thermal Protection Characteristics

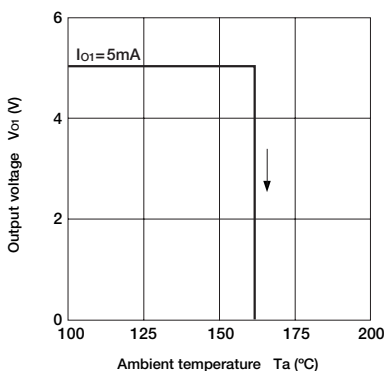

■ T<sub>a</sub>—P<sub>D</sub> Characteristics

