

SANMOTION

CLOSED LOOP STEPPING SYSTEMS

Model No.PB



Ver.10

SANYO DENKI

SANMOTION

CLOSED LOOP STEPPING SYSTEMS

Model No. PB



AC Input Set Models

Type R RS-485+Parallel I/O type
Type P Pulse train input type



DC Input Set Models

Type M Multi-input type



DC Input Drivers / Motors

Type P Multi-axis pulse train input type



DC Input Drivers / Motors

Type E Multi-axis EtherCAT interface



Contents

Features	p. 5
Lineup	p. 6
How to Read Model Numbers	p. 12
AC Input Set Models	
Type R	p. 14
System Configuration Diagram	p. 14
Set Model Configurations	p. 15
Driver Dimensions	p. 16
Driver Specifications	p. 16
Type P	p. 20
System Configuration Diagram	p. 20
Set Model Configurations	p. 21
Driver Dimensions	p. 22
Driver Specifications	p. 22
Specifications	p. 26
Motor Dimensions	p. 31
Motor Specifications	p. 33
DC Input Set Models	
Type M	p. 34
System Configuration Diagram	p. 34
Set Model Configurations	p. 35
Driver Dimensions	p. 36
Driver Specifications	p. 36
Specifications	p. 39
Motor Dimensions	p. 46
Motor Specifications	p. 49
DC Input Drivers / Motors	
Type P Multi-axis	p. 50
System Configuration Diagram	p. 50
Compatible Driver / Motor Combinations	p. 51
Driver Dimensions	p. 52
Driver Specifications	p. 52
Specifications	p. 55
Type E Multi-axis (EtherCAT interface)	p. 62
System Configuration Diagram	p. 62
Compatible Driver / Motor Combinations	p. 63
Driver Dimensions	p. 64
Driver Specifications	p. 64
Specifications	p. 67
Motor Dimensions	p. 79
Motor Specifications	p. 84
Options	p. 85
Safety Precautions	p. 94
Safety Information	p. 94

SANMOTION Model No.PB

CLOSED LOOP STEPPING SYSTEMS

The closed loop stepping system SANMOTION Model No.PB combines the ease-of use of stepping motors and the reliability of servo motors. Closed loop control based on feedback is made possible by the position-detecting encoder mounted on the stepping motor. This simple system delivers more reliable and highly efficient drive than open loop stepping systems.

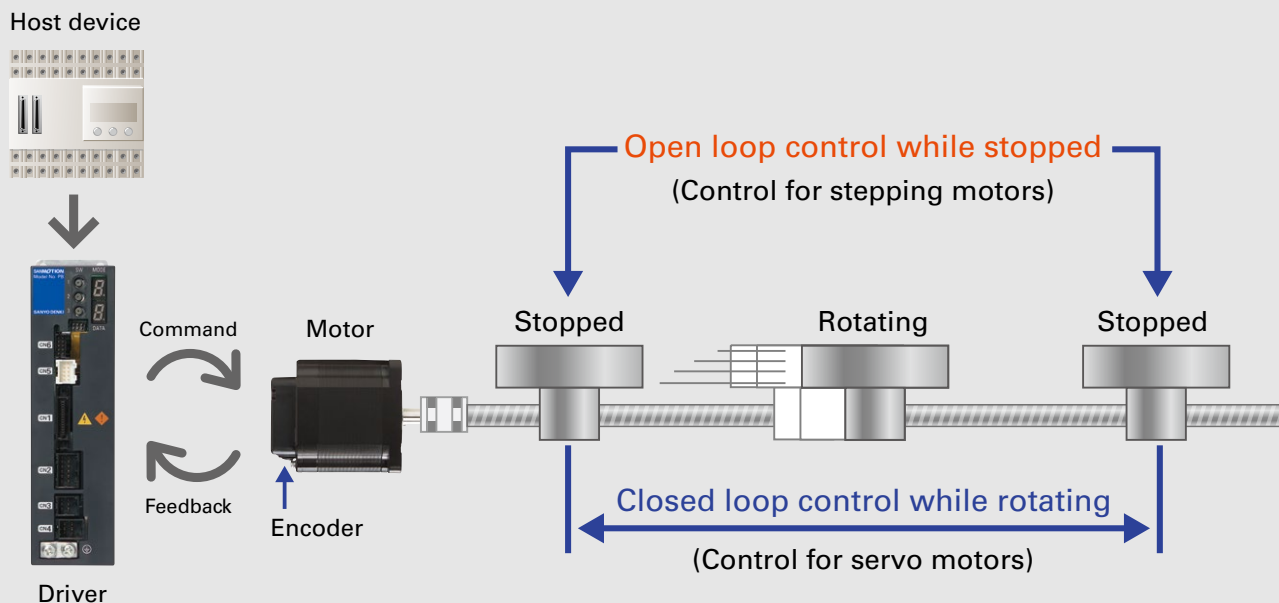

Application Examples

This system can be used in a wide variety of applications utilizing features such as low vibration, low heat generation, and stable stopping.

- Semiconductor manufacturing equipment, analytical and testing devices used in medical and environmental fields, monitoring cameras, and searchlights, etc.



Semiconductor manufacturing equipment
Reliable system achieved by eliminating step-out

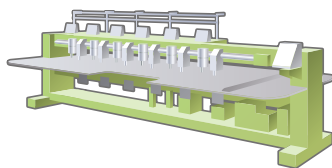

Embroidery machines
Reduced positioning time in short stroke movement



Monitoring cameras
Utilizes the stable stopping feature for camera oscillations



Crystal blank testing devices
A reliable low heat generating motor for the conveying mechanism

All the driver and motor products in this catalog—produced in and after October 2012—are compliant with the tolerances of restricted substances (cadmium, lead, mercury, hexavalent chromium, PBB, and PBDE) included in appendix II of the EU RoHS directive (2011/65/EU). Standard model drivers are compliant with CE (European Norm) and UL standards. The DC input Type P and Type E drivers also comply with the KC Mark standards.

The AC input model motors comply with CE (European Norm) and UL standards.



Features

Device reliability improved by eliminating step-out

Motors with an encoder provide closed loop control that eliminates step-out (displacement), a shortcoming of stepping motors. Device reliability is improved because the motor moves to the target position without step-out even with an increased load.

Also, the encoder constantly monitors the rotor position and various alarms can be issued in case of an error, providing the reliability of servo motors.

All motors are equipped with an encoder

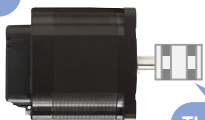

There is no need to worry about step-out even with an increased load

Energy saving

The current flowing to the motor is optimally controlled for the device, for reduced heat generation and highly efficient operation.

Stable stop

This system stops in a stable manner without the hunting (micro vibration) seen with servo motors thanks to holding torque, a feature of stepping motors.

Hunting

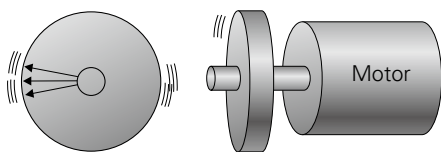

Push operations

Replacement of pneumatic systems is easy as pushing loads can be controlled. It is also suitable for mounters and testers, where driving in the z-axis is required.

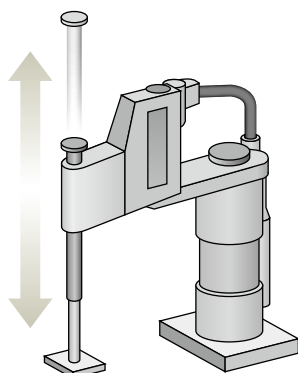

Reduces positioning time

A high torque can be obtained in a low speed area, which makes this system suitable for applications where moving a short distance with short quick steps is required. (Short stroke, high hit rate)

Motor torque can be utilized to the maximum when accelerating and decelerating, shortening positioning time.

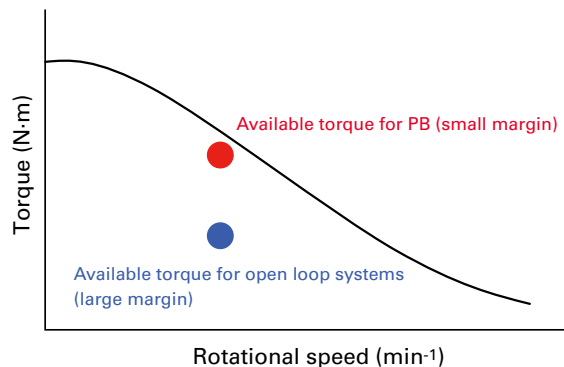

Low vibration

Actual motor speed is monitored and controlled, therefore fewer vibrations are produced compared with open loop stepping systems.

Device startup support and analysis function

Setup software (option) can be used to set parameters and monitor operation status from a PC.

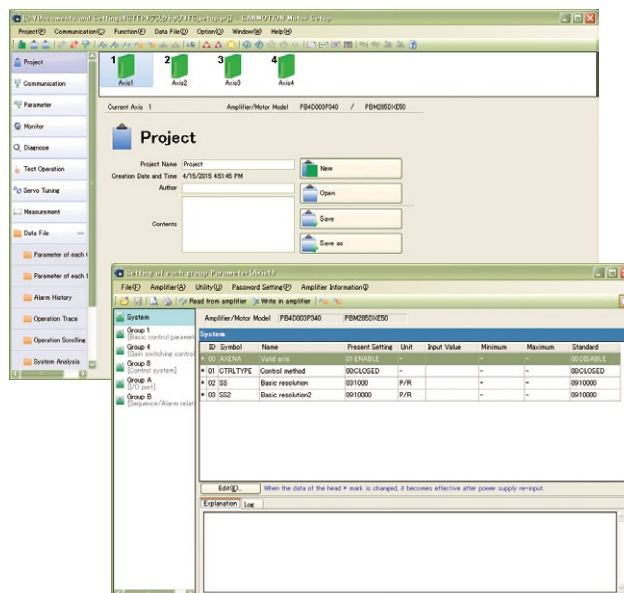

Examples of Monitor Functions

- Positional information...Command position, actual position
- Speed information...Command speed, actual speed
- I/O signal...Dedicated input, general-purpose input
- Alarm information...Current alarm status, logs



Lineup

AC Input

		Type R RS-485+Parallel I/O type	Type P Pulse train input type
Series			
Point command control with host devices such as PLC		✓	—
Network control with serial communication (RS-485)		✓	—
Control with pulse generator		—	✓
Input power supply		100 to 115 VAC or 200 to 230 VAC	100 to 115 VAC or 200 to 230 VAC
Command resolution		500 to 32000 P/R (8 levels)	500 to 32000 P/R (8 levels)
Max. stall torque (standard model)		0.35 to 6.1 N·m	0.35 to 6.1 N·m
Model types and corresponding motor sizes (with gear ratios in parentheses)	Standard model	42 mm sq./60 mm sq./86 mm sq.	42 mm sq./60 mm sq./86 mm sq.
	Low-backlash gear model	42 mm sq./60 mm sq. (1:3.6/1:7.2/1:10/1:20/1:30)	42 mm sq./60 mm sq. (1:3.6/1:7.2/1:10/1:20/1:30)
	Spur gear model	—	—
	Harmonic gear model	42 mm sq. (1:30/1:50/1:100) 60 mm sq. (1:50/1:100)	42 mm sq. (1:30/1:50/1:100) 60 mm sq. (1:50/1:100)
	Electromagnetic brake model	42 mm sq./60 mm sq.	42 mm sq./60 mm sq.
Set configuration items		Driver, Motor, Power cable, I/O signal cable	Driver, Motor, Power cable, I/O signal cable
Page	Driver / Motor specifications	pp. 16, 33	pp. 22, 33
	Specifications / Characteristics diagram	pp. 26 to 30	pp. 26 to 30

Interface

Point command control with host devices such as PLC

Type R, Type M

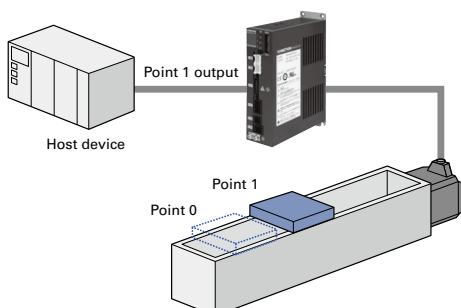

The system can be easily controlled by selecting pre-set point numbers or program numbers with the parallel I/O.

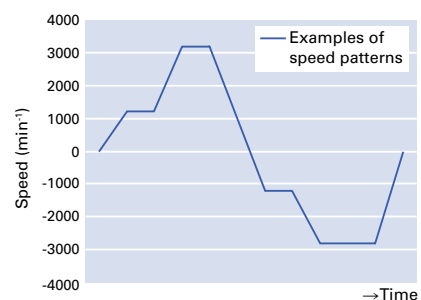

Pushing operation, point designation, programming, and homing mode functions are built in and can be enabled by a single command from the host controller. Complicated operations are easier to handle.



DC Input

	Type M Multi-input type (RS-485+Parallel I/O, Pulse train input selectable)	Type P Multi-axis Pulse train input type
Series		
Point command control with host devices such as PLC	✓	—
Network control with serial communication (RS-485)	✓	—
Control with pulse generator	✓	✓
Input power supply	24/48 VDC (Only 24 VDC is available for the following cases: when used with 28 mm sq. motors, and when single type driver is used with EM brake model motors.)	24/48 VDC
Command resolution	500 to 10000 P/R (6 levels)	200 to 51200 P/R (16 levels)
Max. stall torque (standard model)	0.055 to 1.9 N·m	0.055 to 1.85 N·m
Model types and corresponding motor sizes (with gear ratios in parentheses)	Standard model	28 mm sq./42 mm sq./60 mm sq.
	Low-backlash gear model	42 mm sq./60 mm sq. (1:3.6/1:7.2/1:10/1:20/1:30)
	Spur gear model	28 mm sq. (1:3.6/1:7.2/1:10/1:20/1:30/1:50)
	Harmonic gear model	28 mm sq. (1:50/1:100) 42 mm sq. (1:30/1:50/1:100) 60 mm sq. (1:50/1:100)
	Electromagnetic brake model	28 mm sq./42 mm sq./60 mm sq.
Set configuration items	Driver, Motor, Power cable, I/O signal cable	No set models
Page	Driver / Motor specifications	pp. 36, 49
	Specifications / Characteristics diagram	pp. 39 to 45
		pp. 52, 84
		pp. 55 to 61

Network control with serial communication (RS-485)

Type R, Type M

Uses serial data transmission for speed, acceleration/ deceleration speed, and displacement control

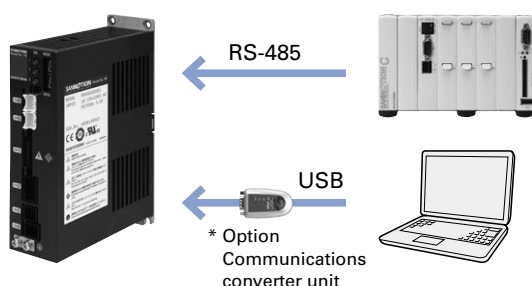

Control with pulse generator

Type P, Type M

Operates in response to the pulse input command from the host device

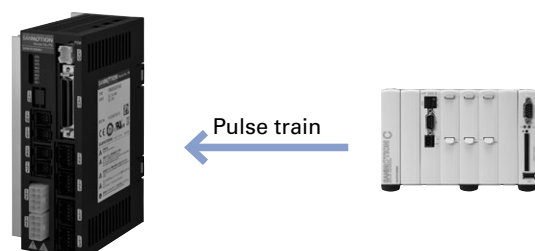



Compatible Driver / Motor / Option Combinations

Motor size	Driver model number		PB4A002R300 PB4A002R301	PB4A002P300 PB4A002P301	PB3D003M200 PB3D003M201	PB4D003P340	
	Number of control axes		1 axes			4 axes	
	Interface specifications		RS-485+Parallel I/O (Type R)	Pulse train (Type P)	RS-485+Parallel I/O, Pulse train (Type M)	Pulse train (Type P)	
	Encoder specifications		Optical incremental				
	Encoder resolution		16000 P/R	16000 P/R	2000 P/R	16000/2000 P/R	
28 mm sq.	Standard model		–	–	PBM282FXE20	PBM281DXE50	
			–	–	PBM284FXE20	PBM285DXE50	
	Spur gear model	1:3.6	–	–	PBM282FGAE20	PBM281DGAE50	
		1:7.2	–	–	PBM282FGBE20	PBM281DGBE50	
		1:10	–	–	PBM282FGEE20	PBM281DGEE50	
		1:20	–	–	PBM282FGGE20	PBM281DGGE50	
		1:30	–	–	PBM282FGJE20	PBM281DGJE50	
		1:50	–	–	PBM282FGLE20	PBM281DGLE50	
	Harmonic gear model	1:50	–	–	PBM282FHLE20	PBM281DHLE50	
		1:100	–	–	PBM282FHME20	PBM281DHME50	
Electromagnetic brake model		–	–	PBM282FCE20	PBM281DCE50		
		–	–	PBM284FCE20	PBM285DCE50		
42 mm sq.	Standard model		PBM423FXK30-M		PBM423FXE20	PBM423DXK50	
	Low-backlash gear model	1:3.6	PBM423FGAK30-M		PBM423FGAE20	PBM423DGAK50	
		1:7.2	PBM423FGBK30-M		PBM423FGBE20	PBM423DGBK50	
		1:10	PBM423FGEK30-M		PBM423FGEE20	PBM423DGEK50	
		1:20	PBM423FGGK30-M		PBM423FGGE20	PBM423DGGK50	
		1:30	PBM423FGJK30-M		PBM423FGJE20	PBM423DGJK50	
	Harmonic gear model	1:30	PBM423FHJK30-M		PBM423FHJE20	PBM423DHJK50	
		1:50	PBM423FHLLK30-M		PBM423FHLE20	PBM423DHLLK50	
		1:100	PBM423FHMK30-M		PBM423FHME20	PBM423DHMK50	
	Electromagnetic brake model		PBM423FCK30-M		PBM423FCE20	PBM423DCK50	
60 mm sq.	Standard model		PBM603FXK30-M		PBM603FXE20	PBM603DXK50	
			PBM604FXK30-M		PBM604FXE20	PBM604DXK50	
	Low-backlash gear model	1:3.6	PBM603FGAK30-M		PBM603FGAE20	PBM603DGAK50	
		1:7.2	PBM603FGBK30-M		PBM603FGBE20	PBM603DGBK50	
		1:10	PBM603FGEK30-M		PBM603FGEE20	PBM603DGEK50	
		1:20	PBM603FGGK30-M		PBM603FGGE20	PBM603DGGK50	
		1:30	PBM603FGJK30-M		PBM603FGJE20	PBM603DGJK50	
	Harmonic gear model	1:50	PBM603FHLLK30-M		PBM603FHLE20	PBM603DHLLK50	
		1:100	PBM603FHMK30-M		PBM603FHME20	PBM603DHMK50	
	Electromagnetic brake model		PBM603FCK30-M		PBM603FCE20	PBM603DCK50	
		PBM604FCK30-M		PBM604FCE20	PBM604DCK50		
86 mm sq.	Standard model		PBM861FXK30-M		–	–	
			PBM862FXK30-M		–	–	
Options	Power cable		PBC8P0010A (Set configuration items)		PBC6P0010A (Set configuration items)	PBC10P00□0A	
	Motor extension cable		PBC7M0030A		PBC6M0030A	PBC8M00□0A	
	Encoder extension cable		PBC7E0030A		PBC6E0030A	PBC7E00□0A	
	I/O signal cable		PBC5S0010A (unshielded) (Set configuration items)	PBC5S0010C (shielded) (Set configuration items)	PBC5S0010A (unshielded)	PBC8S0010C (shielded)	
			PBC5S0010C (shielded)		PBC5S0010C (shielded) (Set configuration items)		
	Communication cable *		PBC6C0003A		PBC6C0003A	–	
	Limit input cable		–		PBC7S0010A	–	
	Power cable (between drivers)		–		–	PBC10P0002B	
	PC interface software		SPBALL-01		SPBA1W-01	SANMOTION MOTOR SETUP SOFTWARE	
	Communications converter unit		PBFM-U6				
Regenerative unit		–		–	PBFE-02		

* Used when multiple-axis drivers are connected in a daisy chain configuration for communication.

Lineup

DC Input

Series		Type E Multi-axis EtherCAT integrated type	
			
Input power supply		24/48 VDC	
Encoder specifications		Optical incremental	Battery-less optical absolute
Command resolution		50 to 1,500,000 P/R	
Max. stall torque (standard model)		0.055 to 1.85 N·m	0.343 to 1.85 N·m
Model types and corresponding motor sizes (with gear ratios in parentheses)	Standard model	28 mm sq./42 mm sq./60 mm sq.	42 mm sq./60 mm sq.
	Low-backlash gear model	42 mm sq./60 mm sq. (1:3.6/1:7.2/1:10/1:20/1:30)	42 mm sq./60 mm sq. (1:3.6/1:7.2/1:10/1:20/1:30)
	Spur gear model	28 mm sq. (1:3.6/1:7.2/1:10/1:20/1:30/1:50)	—
	Harmonic gear model	28 mm sq. (1:50/1:100) 42 mm sq. (1:30/1:50/1:100) 60 mm sq. (1:50/1:100)	42 mm sq. (1:30/1:50/1:100) 60 mm sq. (1:50/1:100)
	Electromagnetic brake model	28 mm sq./42 mm sq./60 mm sq.	42 mm sq./60 mm sq.
Set configuration items		No set models	
Page	Driver / Motor specifications	pp. 64, 84	
	Specifications / Characteristics diagram	pp. 67 to 78	

Interface

EtherCAT interface

EtherCAT is a 100 Mbps high-speed fieldbus system. It contributes to the takt time reduction.

This has shortened the communication cycle time by 4 times* or more that of our current model**, achieving finer and smoother motion of the embedded device. This highly versatile EtherCAT is compatible with Ethernet, which makes it possible to build a system that co-exists with various devices.

Also, the EtherCAT conformance test certificate from a trusted third party has been acquired.



* When compared with our current model: PB4D003E2D0

** Minimum communication cycle time: 0.25 ms (1 ms for the below current model).

High-precision battery-less absolute encoder

In addition to an incremental encoder, a battery-less absolute encoder (Model no. HA035) is also available. This encoder doesn't require a battery change, thus the maintenance of devices can be simplified.

Compatible Driver / Motor / Option Combinations

Motor size	Driver model number		PB4D003E440	
	Number of control axes		4 axes	
	Interface specifications		EtherCAT	
	Encoder specifications		Optical incremental	Battery-less optical absolute
	Encoder resolution		16000/2000 P/R	Single-turn resolution 17 bit Multi-turn resolution 16 bit
28 mm sq.	Standard model		PBM281DXE50	–
			PBM285DXE50	–
	Spur gear model	1:3.6 1:7.2 1:10 1:20 1:30 1:50	PBM281DGAE50	–
			PBM281DGBE50	–
			PBM281DGEE50	–
			PBM281DGGE50	–
			PBM281DGJE50	–
			PBM281DGLE50	–
	Harmonic gear model	1:50 1:100	PBM281DHLE50	–
			PBM281DHME50	–
	Electromagnetic brake model		PBM281DCE50	–
PBM285DCE50			–	
42 mm sq.	Standard model		PBM423DXK50	PBM423DXR50
	Low-backlash gear model	1:3.6 1:7.2 1:10 1:20 1:30	PBM423DGAK50	PBM423DGAR50
			PBM423DGBK50	PBM423DGBR50
			PBM423DGEK50	PBM423DGER50
			PBM423DGGK50	PBM423DGGR50
			PBM423DGJK50	PBM423DGJR50
	Harmonic gear model	1:30 1:50 1:100	PBM423DHJK50	PBM423DHJR50
			PBM423DHLK50	PBM423DHLR50
			PBM423DHMK50	PBM423DHMR50
	Electromagnetic brake model		PBM423DCK50	PBM423DCR50
60 mm sq.	Standard model		PBM603DXK50	PBM603DXR50
			PBM604DXK50	PBM604DXR50
	Low-backlash gear model	1:3.6 1:7.2 1:10 1:20 1:30	PBM603DGAK50	PBM603DGAR50
			PBM603DGBK50	PBM603DGBR50
			PBM603DGEK50	PBM603DGER50
			PBM603DGGK50	PBM603DGGR50
			PBM603DGJK50	PBM603DGJR50
	Harmonic gear model	1:50 1:100	PBM603DHLK50	PBM603DHLR50
			PBM603DHMK50	PBM603DHMR50
	Electromagnetic brake model		PBM603DCK50	PBM603DCR50
			PBM604DCK50	PBM604DCR50
Options	Power cable		PBC10P00□0A	
	Connector set for power cable		PBC10P0000A	
	Power cable (between drivers)		PBC10P0002B	
	Motor extension cable		PBC8M00□0A	
	Connector set for motor cable		PBC8M0000A	
	Encoder extension cable		PBC7E00□0A	
	Connector set for encoder cable		PBC7E0000A	
	I/O signal cable		PBC9S0010C	
	Connector set for I/O signal cable		PBC9S0000C	
	PC communication cable		AL-00896515-0□	
	PC interface software		SANMOTION MOTOR SETUP SOFTWARE	
	Regenerative unit		PBFE-02	

How to Read Model Numbers

Note that not every combination of the following codes and characters is available.

Set model number

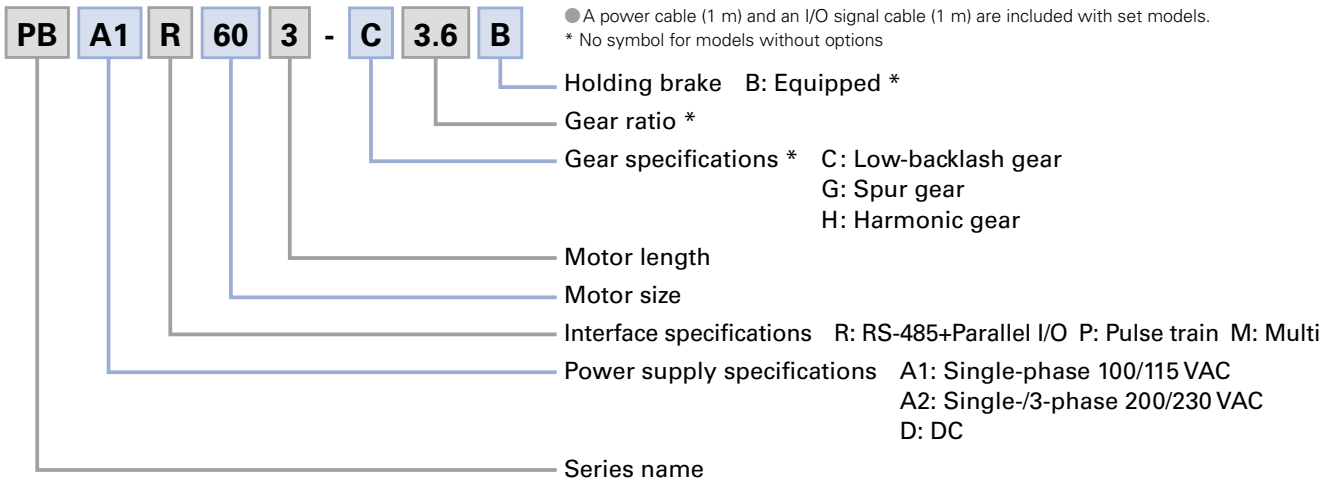

Driver model number

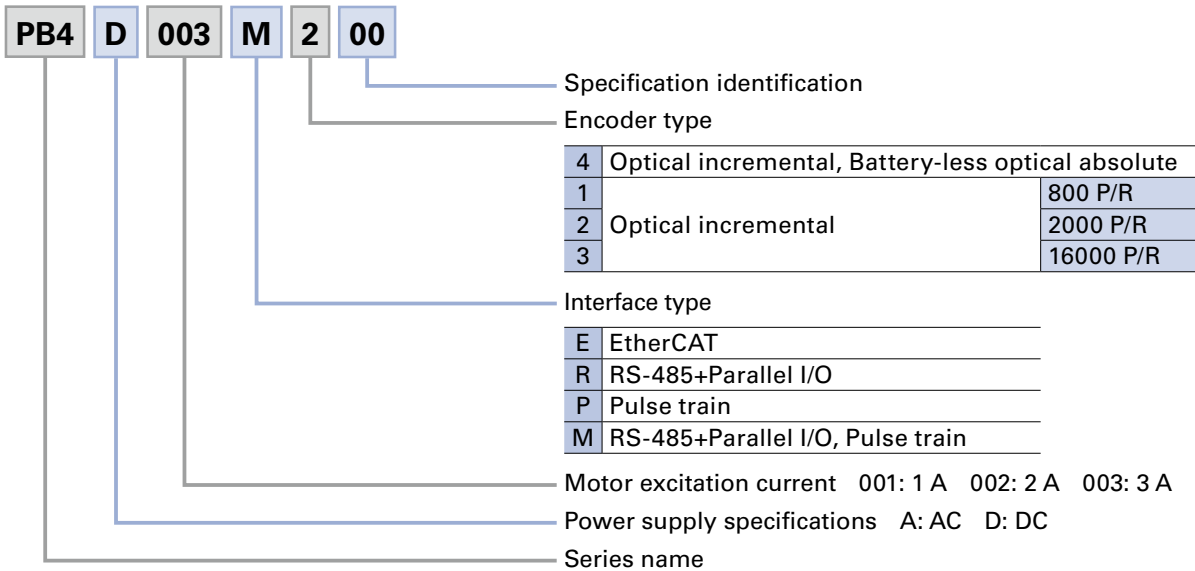

Motor model number

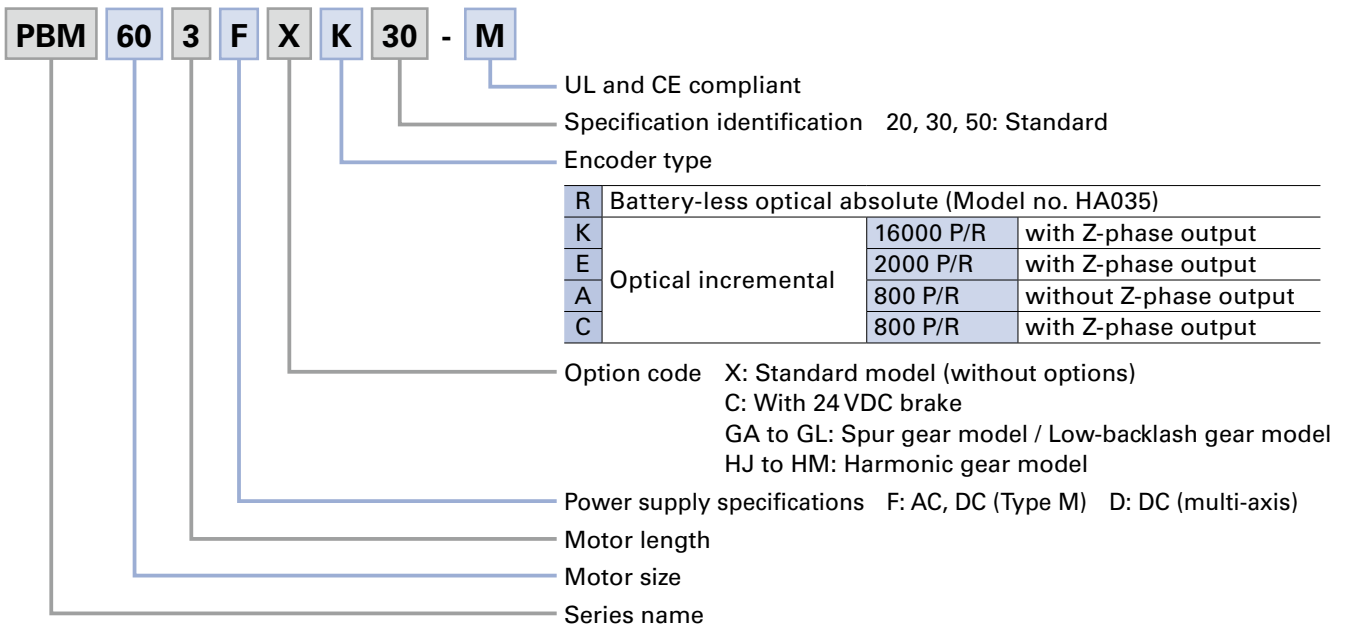

Cable model number

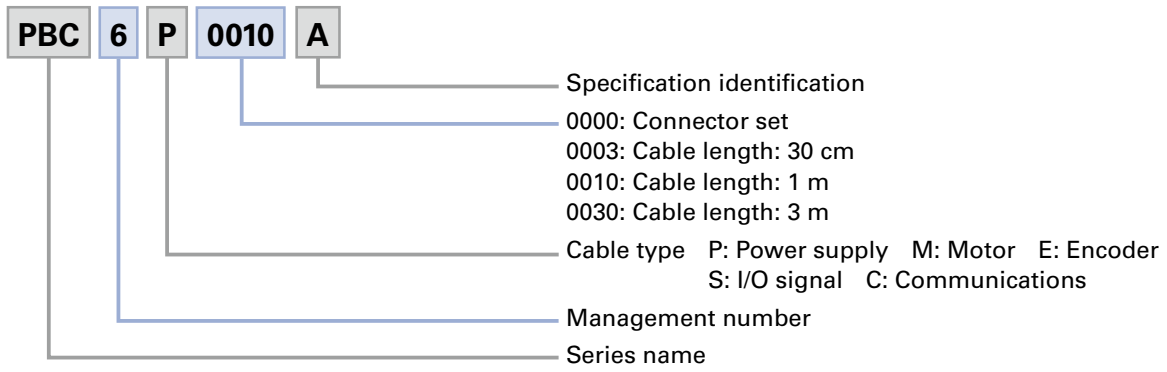

AC Input Set Models

Type R RS-485+Parallel I/O type



Set configuration items RoHS

Motor CE US

Motor size: 42 mm sq., 60 mm sq., 86 mm sq.

Driver CE US

Model number: PB4A002R300

Input power supply: Single-phase 100 to 115 VAC

Model number: PB4A002R301

Input power supply: Single-/3-phase 200 to 230 VAC

Cable

For power supply (1 m) Model number: PBC8P0010A

I/O signal cable (1 m, unshielded) Model number: PBC5S0010A

Set Model Configurations ▶ p. 15 Driver Dimensions ▶ p. 16
 Driver Specifications ▶ p. 16 Specifications / Characteristics Diagram ▶ pp. 26 to 30
 Motor Dimensions ▶ pp. 31 to 32 Motor Specifications ▶ p. 33

System Configuration Diagram

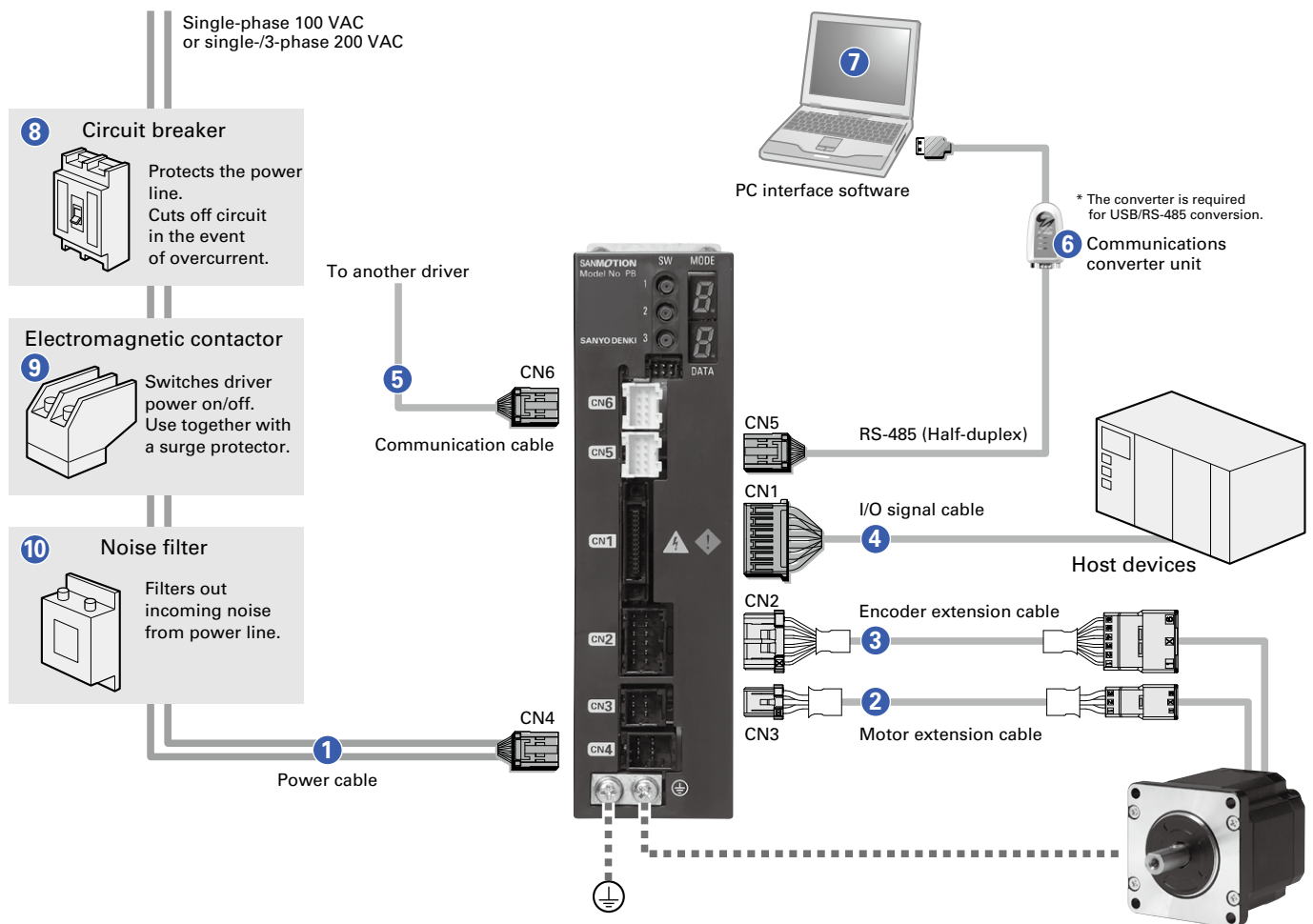

To be provided by the customer. 8 to 10

Set Model Configurations

Model	Motor external dimensions Flange size x Motor length (mm)	Max. stall torque (allowable torque* for models with gear) (N·m)	Allowable speed (min ⁻¹)	Gear ratio	Backlash (deg.)	Driver power supply specifications	Set model	Set configuration items			Page		
								Motor model number	Driver model number	Power cable, I/O signal cable	Specifications	Motor dimensions	
Standard model	42x42x55.9	0.35	—	—	—	Single-phase 100 to 115 VAC	PBA1R423	PBM423FXK30-M	PB4A002R300	Power cable (1 m): PBC8P0010A	p. 26	p. 31	
	42x42x55.9	0.35	—	—	—	Single-/3-phase 200 to 230 VAC	PBA2R423	PBM423FXK30-M	PB4A002R301		p. 26	p. 31	
	60x60x68.8	1.3	—	—	—	Single-phase 100 to 115 VAC	PBA1R603	PBM603FXK30-M	PB4A002R300		p. 26	p. 31	
	60x60x68.8	1.3	—	—	—	Single-/3-phase 200 to 230 VAC	PBA2R603	PBM603FXK30-M	PB4A002R301	I/O signal cable (1 m, unshielded): PBC5S0010A	p. 26	p. 31	
	60x60x100.8	1.9	—	—	—	Single-phase 100 to 115 VAC	PBA1R604	PBM604FXK30-M	PB4A002R300		p. 26	p. 31	
	60x60x100.8	1.9	—	—	—	Single-/3-phase 200 to 230 VAC	PBA2R604	PBM604FXK30-M	PB4A002R301		p. 26	p. 31	
	86x86x79.5	3.1	—	—	—	Single-phase 100 to 115 VAC	PBA1R861	PBM861FXK30-M	PB4A002R300	I/O signal cable (1 m, unshielded): PBC5S0010A	p. 26	p. 31	
	86x86x79.5	3.1	—	—	—	Single-/3-phase 200 to 230 VAC	PBA2R861	PBM861FXK30-M	PB4A002R301		p. 26	p. 31	
	86x86x110	6.1	—	—	—	Single-phase 100 to 115 VAC	PBA1R862	PBM862FXK30-M	PB4A002R300		p. 26	p. 31	
86x86x110	6.1	—	—	—	Single-/3-phase 200 to 230 VAC	PBA2R862	PBM862FXK30-M	PB4A002R301	p. 26	p. 31			
Low-backlash gear model	42x42x86.1	0.343	500	1:3.6	0.6	Single-phase 100 to 115 VAC	PBA1R423-C3.6	PBM423FGAK30-M	PB4A002R300	Power cable (1 m): PBC8P0010A	p. 27	p. 31	
	42x42x86.1	0.343	500	1:3.6	0.6	Single-/3-phase 200 to 230 VAC	PBA2R423-C3.6	PBM423FGAK30-M	PB4A002R301		p. 27	p. 31	
	42x42x86.1	0.686	250	1:7.2	0.4	Single-phase 100 to 115 VAC	PBA1R423-C7.2	PBM423FGBK30-M	PB4A002R300		I/O signal cable (1 m, unshielded): PBC5S0010A	p. 27	p. 31
	42x42x86.1	0.686	250	1:7.2	0.4	Single-/3-phase 200 to 230 VAC	PBA2R423-C7.2	PBM423FGBK30-M	PB4A002R301	p. 27		p. 31	
	42x42x86.1	0.98	180	1:1.0	0.35	Single-phase 100 to 115 VAC	PBA1R423-C10	PBM423FGK30-M	PB4A002R300	p. 27		p. 31	
	42x42x86.1	0.98	180	1:1.0	0.35	Single-/3-phase 200 to 230 VAC	PBA2R423-C10	PBM423FGK30-M	PB4A002R301	p. 27	p. 31		
	42x42x86.1	1.47	90	1:2.0	0.25	Single-phase 100 to 115 VAC	PBA1R423-C20	PBM423FGGK30-M	PB4A002R300	Power cable (1 m): PBC8P0010A	p. 27	p. 31	
	42x42x86.1	1.47	90	1:2.0	0.25	Single-/3-phase 200 to 230 VAC	PBA2R423-C20	PBM423FGGK30-M	PB4A002R301		p. 27	p. 31	
	42x42x86.1	1.47	60	1:3.0	0.25	Single-phase 100 to 115 VAC	PBA1R423-C30	PBM423FGJK30-M	PB4A002R300		p. 27	p. 31	
	42x42x86.1	1.47	60	1:3.0	0.25	Single-/3-phase 200 to 230 VAC	PBA2R423-C30	PBM423FGJK30-M	PB4A002R301	p. 27	p. 31		
	60x60x114.3	1.25	500	1:3.6	0.55	Single-phase 100 to 115 VAC	PBA1R603-C3.6	PBM603FGAK30-M	PB4A002R300	I/O signal cable (1 m, unshielded): PBC5S0010A	p. 28	p. 31	
	60x60x114.3	1.25	500	1:3.6	0.55	Single-/3-phase 200 to 230 VAC	PBA2R603-C3.6	PBM603FGAK30-M	PB4A002R301		p. 28	p. 31	
	60x60x114.3	2.5	250	1:7.2	0.25	Single-phase 100 to 115 VAC	PBA1R603-C7.2	PBM603FGBK30-M	PB4A002R300		p. 28	p. 31	
	60x60x114.3	2.5	250	1:7.2	0.25	Single-/3-phase 200 to 230 VAC	PBA2R603-C7.2	PBM603FGBK30-M	PB4A002R301	p. 28	p. 31		
	60x60x114.3	3	180	1:1.0	0.25	Single-phase 100 to 115 VAC	PBA1R603-C10	PBM603FGK30-M	PB4A002R300	Power cable (1 m): PBC8P0010A	p. 28	p. 31	
	60x60x114.3	3	180	1:1.0	0.25	Single-/3-phase 200 to 230 VAC	PBA2R603-C10	PBM603FGK30-M	PB4A002R301		p. 28	p. 31	
	60x60x114.3	3.5	90	1:2.0	0.17	Single-phase 100 to 115 VAC	PBA1R603-C20	PBM603FGGK30-M	PB4A002R300		p. 28	p. 31	
	60x60x114.3	3.5	90	1:2.0	0.17	Single-/3-phase 200 to 230 VAC	PBA2R603-C20	PBM603FGGK30-M	PB4A002R301	p. 28	p. 31		
	60x60x114.3	4	60	1:3.0	0.17	Single-phase 100 to 115 VAC	PBA1R603-C30	PBM603FGJK30-M	PB4A002R300	I/O signal cable (1 m, unshielded): PBC5S0010A	p. 28	p. 31	
	60x60x114.3	4	60	1:3.0	0.17	Single-/3-phase 200 to 230 VAC	PBA2R603-C30	PBM603FGJK30-M	PB4A002R301		p. 28	p. 31	
	42x42x95.1	2.2 (4.5)	116	1:3.0	—	—	Single-phase 100 to 115 VAC	PBA1R423-H30	PBM423FHJK30-M		PB4A002R300	p. 29	p. 32
	42x42x95.1	2.2 (4.5)	116	1:3.0	—	—	Single-/3-phase 200 to 230 VAC	PBA2R423-H30	PBM423FHJK30-M	PB4A002R301	Power cable (1 m): PBC8P0010A	p. 29	p. 32
	42x42x95.1	3.5 (8.3)	70	1:5.0	—	—	Single-phase 100 to 115 VAC	PBA1R423-H50	PBM423FHJK30-M	PB4A002R300		p. 29	p. 32
	42x42x95.1	3.5 (8.3)	70	1:5.0	—	—	Single-/3-phase 200 to 230 VAC	PBA2R423-H50	PBM423FHJK30-M	PB4A002R301		p. 29	p. 32
42x42x95.1	5 (11)	35	1:1.00	—	—	Single-phase 100 to 115 VAC	PBA1R423-H100	PBM423FHMK30-M	PB4A002R300	I/O signal cable (1 m, unshielded): PBC5S0010A	p. 29	p. 32	
42x42x95.1	5 (11)	35	1:1.00	—	—	Single-/3-phase 200 to 230 VAC	PBA2R423-H100	PBM423FHMK30-M	PB4A002R301		p. 29	p. 32	
60x60x135.8	5.5 (14)	70	1:5.0	—	—	Single-phase 100 to 115 VAC	PBA1R603-H50	PBM603FHJK30-M	PB4A002R300		p. 29	p. 32	
60x60x135.8	5.5 (14)	70	1:5.0	—	—	Single-/3-phase 200 to 230 VAC	PBA2R603-H50	PBM603FHJK30-M	PB4A002R301	p. 29	p. 32		
60x60x135.8	8 (20)	35	1:1.00	—	—	Single-phase 100 to 115 VAC	PBA1R603-H100	PBM603FHMK30-M	PB4A002R300	Power cable (1 m): PBC8P0010A	p. 29	p. 32	
60x60x135.8	8 (20)	35	1:1.00	—	—	Single-/3-phase 200 to 230 VAC	PBA2R603-H100	PBM603FHMK30-M	PB4A002R301		p. 29	p. 32	
42x42x88.3	0.35	—	—	—	—	Single-phase 100 to 115 VAC	PBA1R423-B	PBM423FCK30-M	PB4A002R300		I/O signal cable (1 m, unshielded): PBC5S0010A	p. 30	p. 32
42x42x88.3	0.35	—	—	—	—	Single-/3-phase 200 to 230 VAC	PBA2R423-B	PBM423FCK30-M	PB4A002R301	p. 30		p. 32	
60x60x108.1	1.3	—	—	—	—	Single-phase 100 to 115 VAC	PBA1R603-B	PBM603FCK30-M	PB4A002R300	p. 30		p. 32	
60x60x108.1	1.3	—	—	—	—	Single-/3-phase 200 to 230 VAC	PBA2R603-B	PBM603FCK30-M	PB4A002R301	p. 30	p. 32		
60x60x140.1	1.9	—	—	—	—	Single-phase 100 to 115 VAC	PBA1R604-B	PBM604FCK30-M	PB4A002R300	Power cable (1 m): PBC8P0010A	p. 30	p. 32	
60x60x140.1	1.9	—	—	—	—	Single-/3-phase 200 to 230 VAC	PBA2R604-B	PBM604FCK30-M	PB4A002R301		p. 30	p. 32	

* Numbers in parenthesis following allowable torques indicate allowable instantaneous torques.

Options and Peripherals

Product names	Standard model number (length)	Connector set model number	Extendable max. length	Remarks	Page
① Power cable	PBC8P0010A (1 m)	PBC8P0000A	3 m	—	p. 87
② Motor extension cable	PBC7M0030A (3 m)	PBC7M0000A	20 m	An extension cable is required when the distance between the motor and driver exceeds 50 cm.	p. 87
③ Encoder extension cable	PBC7E0030A (3 m)	PBC7E0000A	20 m	An extension cable is required when the distance between the motor and driver exceeds 50 cm.	p. 87
④ I/O signal cable (unshielded)	PBC5S0010A (1 m)	PBC5S0000A	2 m	Select the cable depending on peripheral noise.	p. 87
④ I/O signal cable (shielded)	PBC5S0010C (1 m)	PBC5S0000A	2 m	Select the cable depending on peripheral noise.	p. 88
⑤ Communication cable (between drivers)	PBC6C0003A (30 cm)	PBC6C0000A	100 m	Used when multiple axes are connected in a daisy chain configuration for communication.	p. 88
⑥ Communications converter unit	PBFM-U6	—	—	A set of a converter (USB/RS-485) and a cable	p. 86
⑦ PC interface software	SPBALL-01	—	—	Software for checking operation and parameter setting	p. 86

AC Input Set Models Type R

AC Input Set Models Type P

DC Input Set Models Type M

DC Input Drivers / Motors Type P Multi-axis

DC Input Drivers / Motors Type E Multi-axis EtherCAT interface

Driver Dimensions Unit: mm

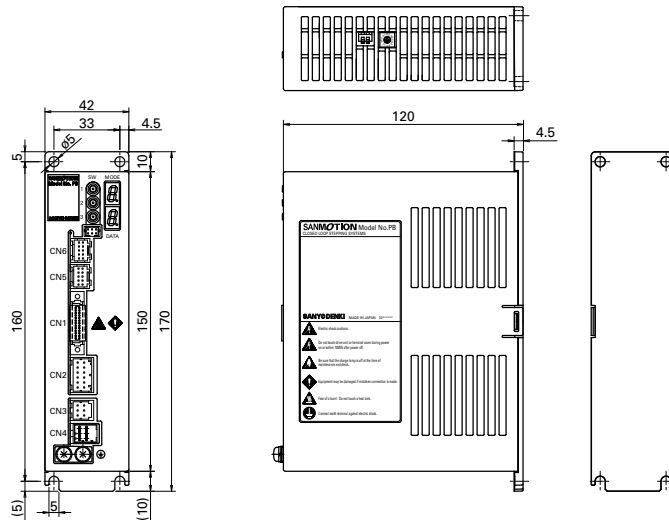

Driver Specifications

General specifications

	Model number	PB4A002R300	PB4A002R301	
Basic specifications	Interface	RS-485+Parallel I/O		
	Input power supply	Single-phase 100 to 115 VAC (-15%, +10%) 50/60 Hz	Single-phase 200 to 230 VAC (-15%, +10%) 50/60 Hz 3-phase 200 to 230 VAC (-15%, +10%) 50/60 Hz	
	Control method	PWM control: Sinusoidal drive method		
	Power supply current	6 A	2.5 A	
	Environment	Protection class	Class I	
		Operation environment	Installation category (overvoltage category): II, Pollution degree: 2	
		Operating ambient temperature	0 to +55°C	
		Storage temperature	-20 to +65°C	
		Operating ambient humidity	90% RH max. (non-condensing)	
		Storage humidity	90% RH max. (non-condensing)	
Operation altitude		1000 m or less above sea level		
Vibration resistance		Tested under the following conditions: Acceleration: 5 m/s ² , Frequency range: 10 to 55 Hz, Axes of vibration: X, Y, Z (2 hours each)		
Impact resistance		20 m/s ²		
Dielectric strength	No error observed when 1.5 kVAC is applied between power input terminal and frame for one minute.			
Insulation resistance	10 MΩ min. when measured with a 500 VDC megohmmeter between input terminal and frame.			
Functions	Mass	0.65 kg		
	Rotational speed	0 to 4500 min ⁻¹ (0 to 4000 min ⁻¹ for 86 mm sq. motors)		
	Command resolution (P/R)	500, 1000, 2000, 4000, 5000, 10000, 16000, 32000		
	Holding brake control function	Built in		
	Protection functions	Power voltage error, regenerative voltage error, driver overheat, motor overheat, overload stop, over-speed, servo error, homing mode error, deviation counter overflow, wrap around, push operation error, encoder disconnection, initialization error, overcurrent, nonvolatile memory error, CPU error		
	Display / Indication	7-segment LED display (2)		
	Digital operator	Resolution, applicable motor, forward direction definition, gain, Jog speed, Jog operation, node address, baud rate, holding brake control, teaching		
	Operating functions	Auto homing mode operation / Push (current control) operation / Relative motion command / Absolute motion command Module function, Jog operation		
	Communication specifications	Communications with controller	RS-485 Start / stop synchronization, half-duplex communication	Baud rate: 9600, 38400, 115200, 307200 bps
		PC interface	RS-485 Start / stop synchronization, half-duplex communication	Baud rate: 115200 bps
I/O signal	Input signal	Function	ALMCLR General-purpose input×8 (select from Point, STOP, EXE, SELECT, HOME sensor, Limit, Deviation clear, Pause, Jog, and Inter lock)	
		Electrical specifications	General-purpose input: Bidirectional input photocoupler 5 to 24 VDC	
	Output signal	Function	ALMCLR General-purpose output×7 (select from Point No, Ack, Busy, HOME END, Push END, ZONE, Input monitor, In-Position, and Bit Out)	
		Electrical specifications	General-purpose output: Open collector 30 VDC, 15 mA or less	

* A function that finely adjusts the unit step angle per pulse parameters. Setup software is required.

Safety standards

	Directives	Standard	
CE (TÜV)	Low-voltage directives	EN 61800-5-1	
	EMC directives	EN 61800-3	
		EN 61000-6-2	
UL	Acquired standards	Applicable standard	File no.
	UL	UL 508C	E179775
	cUL		

External Wiring Diagram

Single-phase 100 to 115 VAC Driver model number: PB4A002R300

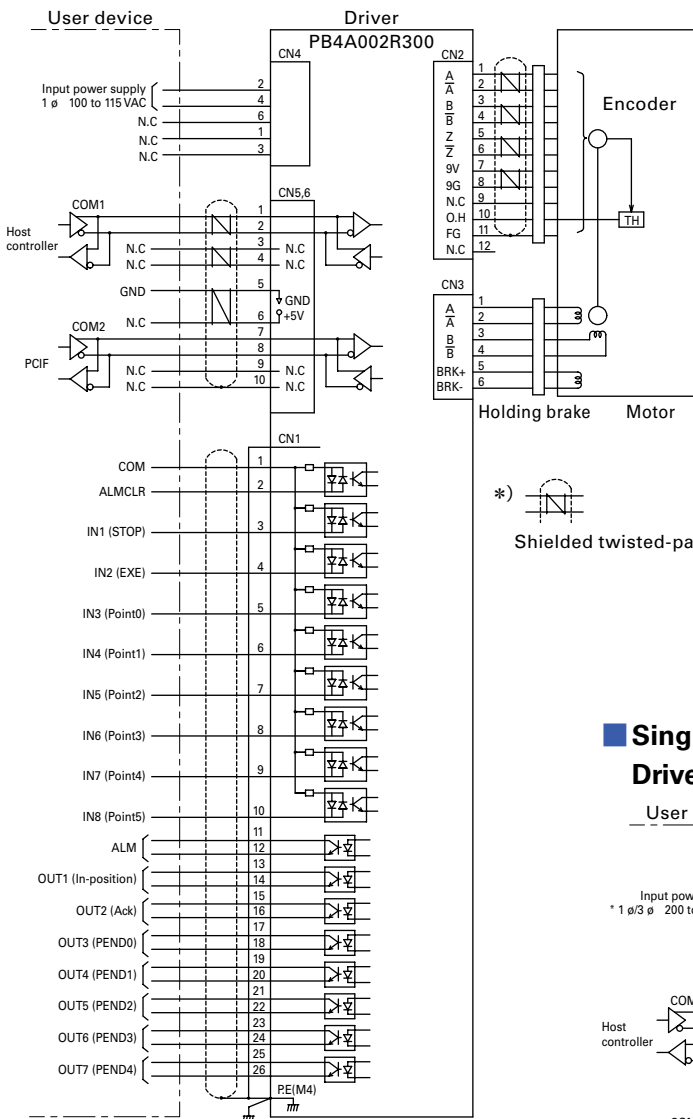

Single-/3-phase 200 to 230 VAC Driver model number: PB4A002R301

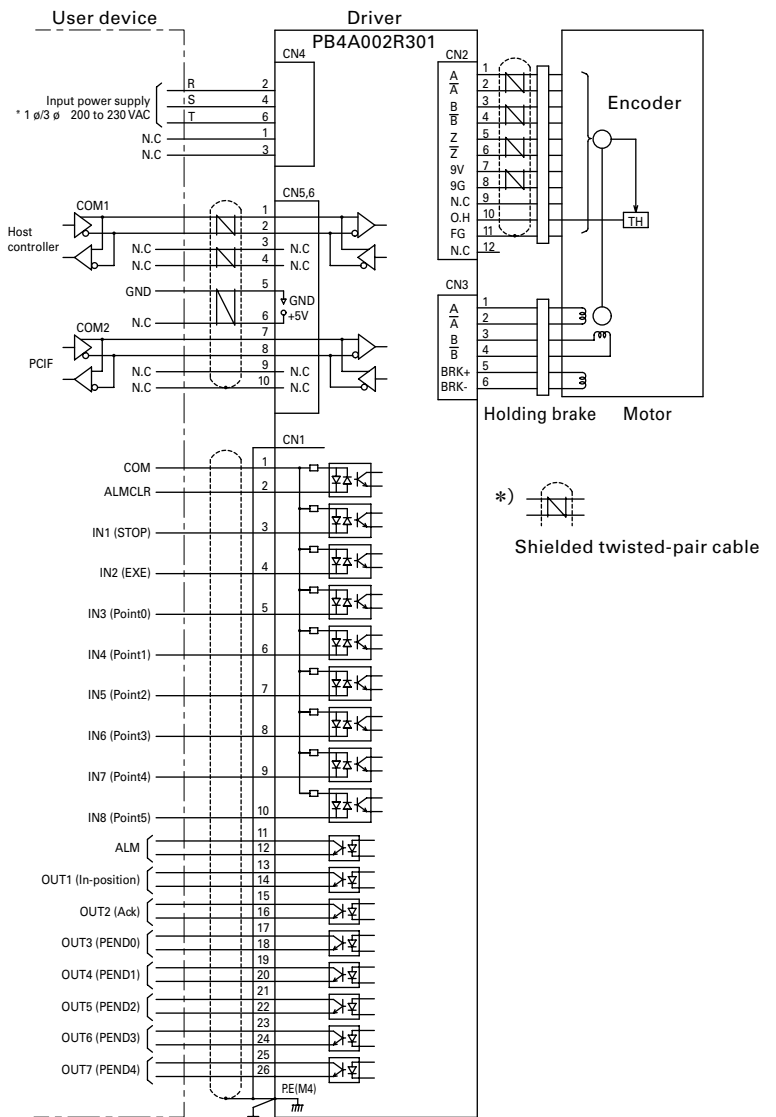

● () indicates factory settings.

* When using with single-phase power supply, wire to pins 2 and 4.

Wiring

Connector Models and Compatible Cables

Application	Connector no.	Description	Manufacturer model number	Compatible cables	Maximum extension length	Manufacturer
I/O signals	CN1	Plug (driver side)	8830E-026-170LD-F	AWG28 (7/0.127)	2 m	KEL CORPORATION
		Receptacle	8822E-026-171D			
Encoder	CN2	Tab header (driver side)	1-1827876-6	AWG22 to 28 Shielded twisted pair *The contact model number varies with diameter over outer shield.	20 m	Tyco Electronics Japan G.K.
		Receptacle housing	1-1827864-6			
		Receptacle contact	1827569-2 (AWG28 to 30) 1827570-2 (AWG22 to 28)			
		Tab housing (for relay)	1-1903130-6			
		Tab contact (for relay)	1903111-2 (AWG28 to 30) 1903112-2 (AWG22 to 28)			
		Motor	CN3			
Receptacle housing	1-1827864-3					
Receptacle contact	1827570-2 (AWG22 to 28) 1827572-2 (AWG18 to 22)					
Tab housing (for relay)	1-1903130-3					
Tab contact (for relay)	1903112-2 (AWG22 to 28) 1903114-2 (AWG18 to 22)					
Power supply	CN4	Tab header (driver side)		1376136-1	AWG18 Discrete line	2 m
Receptacle housing		1-1318119-3				
Receptacle contact		1318107-1 (single) 1318105-1 (linked)				
Communications	CN5	Post with base (driver side)	S10B-PADSS-1GW	AWG28 to 24 Shielded twisted pair	100 m	J.S.T.
	CN6	Housing	PADP-10V-1-S			
		Contact	SPH-002T-P0.5L			

- Refer to the manufacturer's catalog for detailed connector specifications.
- If the maximum extended length is exceeded, take necessary countermeasures to prevent malfunctions due to line noise.
- The relay connector is used to connect to the motor or encoder side connector when creating an extension cable.

Driver Components and functions

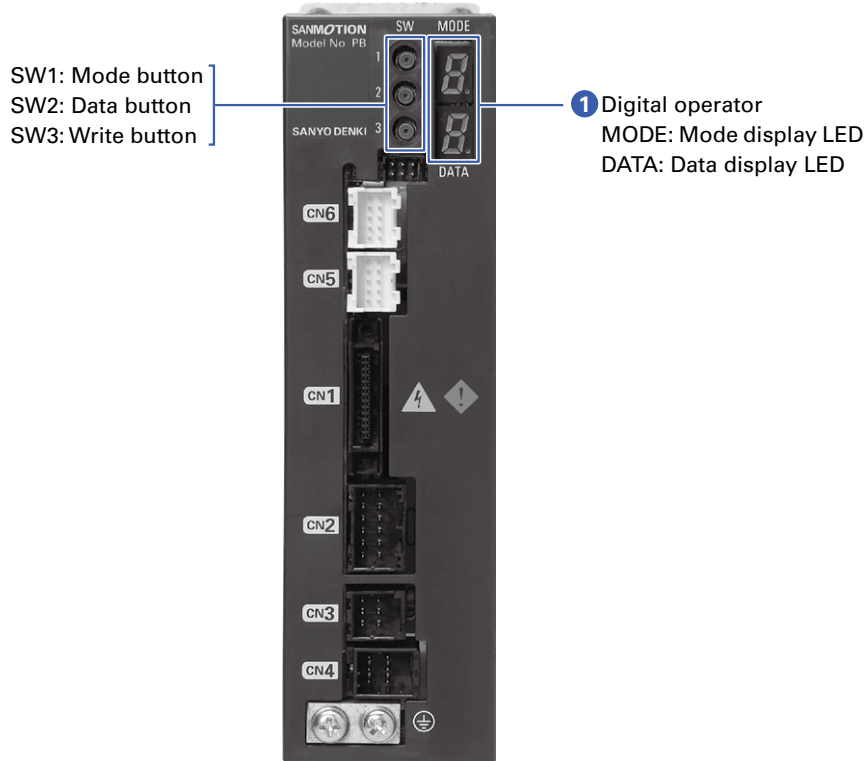

SW1: Mode button
SW2: Data button
SW3: Write button

1 Digital operator
MODE: Mode display LED
DATA: Data display LED

1 Digital operator
Used to set parameters and perform Jog operations.

Display

- **MODE (Mode display LED)**
Displays the current mode number.
- **DATA (Data display LED)**
Displays monitor and parameter setting values.
Blinks when the displayed parameter setting value is different from the current setting value.

Button

- **SW1 (Mode button)**
Mode numbers switch sequentially each time the button is pressed.
However, the mode number 9 is only displayed when the servo is ON.
- **SW2 (Data button)**
The function varies with mode number.
- **SW3 (Write button)**
The function varies with mode number.

Functions

MODE	Functions	Data range (DATA display)	SW2 Functions	SW3 Functions
0	Driver status display	(See table 1.)	Disabled	Disabled
1	Point teaching	0 to F (Point no.)	Selects point no.	Confirms at the current position
2	Motor selection	0 to 6 (See table 2.)	Switches set values	Writes set values
3	Resolution selection	0 to 7 (See table 3.)	Switches set values	Writes set values
4	Forward direction setting	0 = CW is forward, 1 = CCW is forward	Switches set values	Writes set values
5	Speed loop gain setting	0 to F	Switches set values	Writes set values
6	Holding brake operation	0 = Release; 1 = Hold	Switches set values	Writes set values
7	Node address setting	0 to F	Switches set values	Writes set values
8	Jog operation speed	1 to F (100 min ⁻¹ /LSB)	Switches set values	Writes set values
9	Jog operation	-	Forward direction operation	Reverse direction operation
A	Baud rate	0 = 9600 bps, 1 = 38400 bps, 2 = 115200 bps, 3 = 307200 bps	Switches set values	Writes set values

- Changed values for modes 2 to 4 are enabled upon restart.
- Changed values for modes 1, 5 to 8, and A are enabled immediately.

Table 1 Driver status and corresponding DATA parameters when MODE parameter is 0.

Displayed data	Driver status	Displayed data	Driver status
0	Servo OFF	9	Homing mode error
Figure-8 pattern	Servo ON	A	Deviation counter overflow
1	Low voltage error	b	Overcurrent (motor winding detection)
2	Overvoltage error	C	Wrap around
3	Regenerative voltage error	d	Push operation error
4	Driver overheat error	E	Encoder disconnection error
5	Motor overheat error	F	Initialization error
6	Overload stop error	H	Overcurrent (bus current detection)
7	Overspeed	L	Nonvolatile memory error
8	Servo error		

Table 2 Motor selection

Set value	Motor model number	Set value	Motor model number
0	PBM423	4	PBM604
1	PBM503	5	PBM861
2	PBM565	6	PBM862
3	PBM603		

Table 3 Resolution selection (P/R)

Set value	Resolution	Set value	Resolution
0	500	4	5000
1	1000	5	10000
2	2000	6	16000
3	4000	7	32000

AC Input Set Models

Type P Pulse Train Input type



Set configuration items RoHS

Motor CE US

Motor size: 42 mm sq., 60 mm sq., 86 mm sq.

Driver CE US

Model number: PB4A002P300

Input power supply: Single-phase 100 to 115 VAC

Model number: PB4A002P301

Input power supply: Single-/3-phase 200 to 230 VAC

Cable

For power supply (1 m) Model number: PBC8P0010A

I/O signal cable (1 m, shielded) Model number: PBC5S0010C

Set Model Configurations ▶ p. 21 Driver Dimensions ▶ p. 22

Driver Specifications ▶ p. 22 Specifications / Characteristics Diagram ▶ pp. 26 to 30

Motor Dimensions ▶ pp. 31 to 32 Motor Specifications ▶ p. 33

System Configuration Diagram

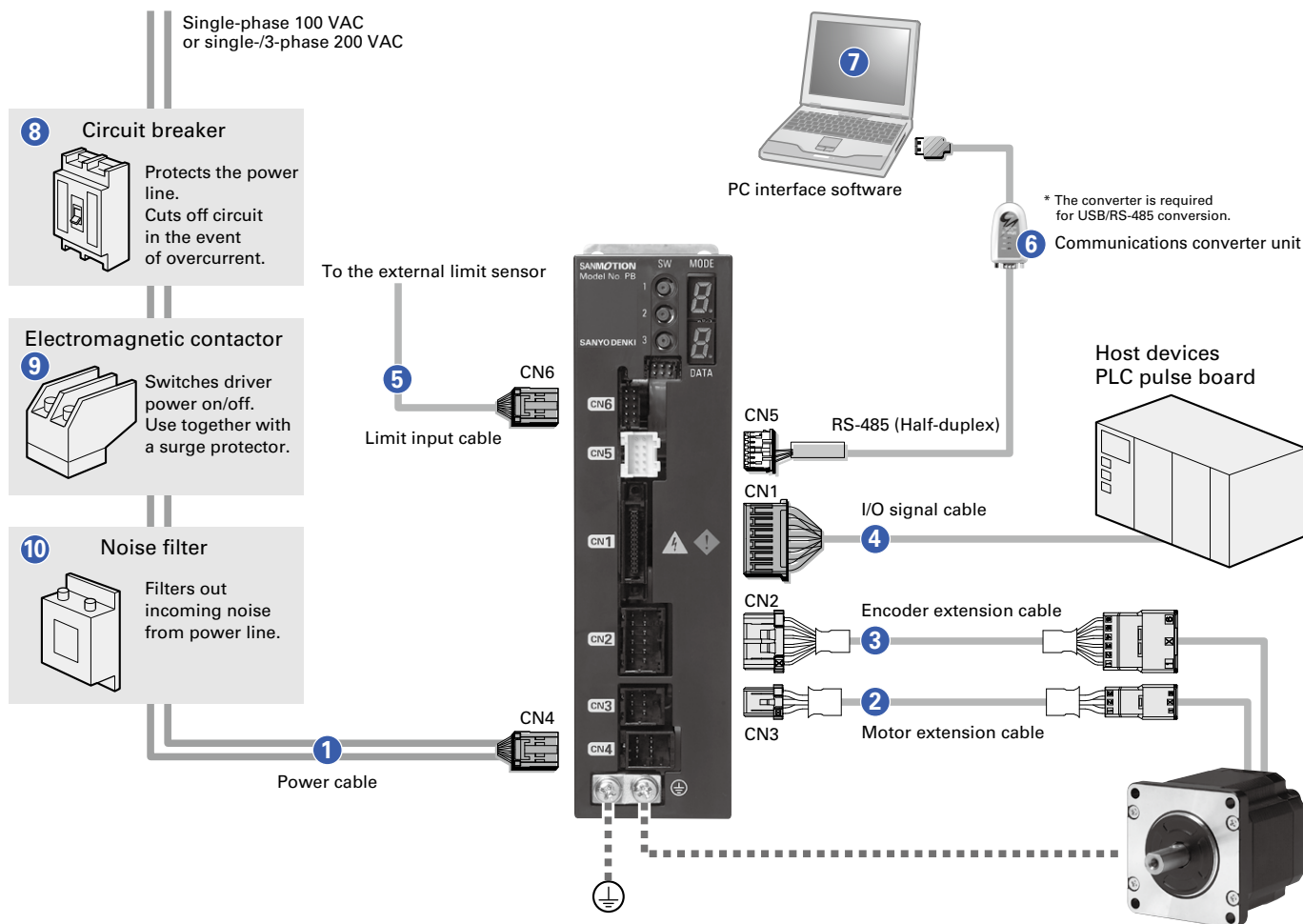

To be provided by the customer. 8 to 10

Set Model Configurations

Model	Motor external dimensions Flange size x Motor length (mm)	Max. stall torque (allowable torque* for models with gear) (N·m)	Allowable speed (min ⁻¹)	Gear ratio	Backlash (deg.)	Driver power supply specifications	Set model	Set configuration items			Page			
								Motor model number	Driver model number	Power cable, I/O signal cable	Specifications	Motor dimensions		
Standard model	42x42x55.9	0.35	—	—	—	Single-phase 100 to 115 VAC	PBA1P423	PBM423FXK30-M	PB4A002P300	Power cable (1 m): PBC8P0010A	p. 26	p. 31		
	42x42x55.9	0.35	—	—	—	Single-/3-phase 200 to 230 VAC	PBA2P423	PBM423FXK30-M	PB4A002P301		p. 26	p. 31		
	60x60x68.8	1.3	—	—	—	Single-phase 100 to 115 VAC	PBA1P603	PBM603FXK30-M	PB4A002P300		p. 26	p. 31		
	60x60x68.8	1.3	—	—	—	Single-/3-phase 200 to 230 VAC	PBA2P603	PBM603FXK30-M	PB4A002P301		p. 26	p. 31		
	60x60x100.8	1.9	—	—	—	Single-phase 100 to 115 VAC	PBA1P604	PBM604FXK30-M	PB4A002P300		p. 26	p. 31		
	60x60x100.8	1.9	—	—	—	Single-/3-phase 200 to 230 VAC	PBA2P604	PBM604FXK30-M	PB4A002P301		p. 26	p. 31		
	86x86x79.5	3.1	—	—	—	Single-phase 100 to 115 VAC	PBA1P861	PBM861FXK30-M	PB4A002P300		I/O Signal Cable (1 m, shielded): PBC5S0010C	p. 26	p. 31	
	86x86x79.5	3.1	—	—	—	Single-/3-phase 200 to 230 VAC	PBA2P861	PBM861FXK30-M	PB4A002P301			p. 26	p. 31	
86x86x110	6.1	—	—	—	Single-phase 100 to 115 VAC	PBA1P862	PBM862FXK30-M	PB4A002P300	p. 26	p. 31				
86x86x110	6.1	—	—	—	Single-/3-phase 200 to 230 VAC	PBA2P862	PBM862FXK30-M	PB4A002P301	p. 26	p. 31				
Low-backlash gear model	42x42x86.1	0.343	500	1:3.6	0.6	Single-phase 100 to 115 VAC	PBA1P423-C3.6	PBM423FGAK30-M	PB4A002P300	Power cable (1 m): PBC8P0010A	p. 27	p. 31		
	42x42x86.1	0.343	500	1:3.6	0.6	Single-/3-phase 200 to 230 VAC	PBA2P423-C3.6	PBM423FGAK30-M	PB4A002P301		p. 27	p. 31		
	42x42x86.1	0.686	250	1:7.2	0.4	Single-phase 100 to 115 VAC	PBA1P423-C7.2	PBM423FGBK30-M	PB4A002P300		p. 27	p. 31		
	42x42x86.1	0.686	250	1:7.2	0.4	Single-/3-phase 200 to 230 VAC	PBA2P423-C7.2	PBM423FGBK30-M	PB4A002P301		p. 27	p. 31		
	42x42x86.1	0.98	180	1:1.0	0.35	Single-phase 100 to 115 VAC	PBA1P423-C10	PBM423FGEK30-M	PB4A002P300		p. 27	p. 31		
	42x42x86.1	0.98	180	1:1.0	0.35	Single-/3-phase 200 to 230 VAC	PBA2P423-C10	PBM423FGEK30-M	PB4A002P301		p. 27	p. 31		
	42x42x86.1	1.47	90	1:2.0	0.25	Single-phase 100 to 115 VAC	PBA1P423-C20	PBM423FGGK30-M	PB4A002P300		p. 27	p. 31		
	42x42x86.1	1.47	90	1:2.0	0.25	Single-/3-phase 200 to 230 VAC	PBA2P423-C20	PBM423FGGK30-M	PB4A002P301		p. 27	p. 31		
	42x42x86.1	1.47	60	1:3.0	0.25	Single-phase 100 to 115 VAC	PBA1P423-C30	PBM423FGJK30-M	PB4A002P300		p. 27	p. 31		
	42x42x86.1	1.47	60	1:3.0	0.25	Single-/3-phase 200 to 230 VAC	PBA2P423-C30	PBM423FGJK30-M	PB4A002P301		p. 27	p. 31		
	60x60x114.3	1.25	500	1:3.6	0.55	Single-phase 100 to 115 VAC	PBA1P603-C3.6	PBM603FGAK30-M	PB4A002P300		I/O Signal Cable (1 m, shielded): PBC5S0010C	p. 28	p. 31	
	60x60x114.3	1.25	500	1:3.6	0.55	Single-/3-phase 200 to 230 VAC	PBA2P603-C3.6	PBM603FGAK30-M	PB4A002P301			p. 28	p. 31	
	60x60x114.3	2.5	250	1:7.2	0.25	Single-phase 100 to 115 VAC	PBA1P603-C7.2	PBM603FGBK30-M	PB4A002P300			p. 28	p. 31	
	60x60x114.3	2.5	250	1:7.2	0.25	Single-/3-phase 200 to 230 VAC	PBA2P603-C7.2	PBM603FGBK30-M	PB4A002P301			p. 28	p. 31	
	60x60x114.3	3	180	1:1.0	0.25	Single-phase 100 to 115 VAC	PBA1P603-C10	PBM603FGEK30-M	PB4A002P300			p. 28	p. 31	
	60x60x114.3	3	180	1:1.0	0.25	Single-/3-phase 200 to 230 VAC	PBA2P603-C10	PBM603FGEK30-M	PB4A002P301			p. 28	p. 31	
	60x60x114.3	3.5	90	1:2.0	0.17	Single-phase 100 to 115 VAC	PBA1P603-C20	PBM603FGGK30-M	PB4A002P300			p. 28	p. 31	
	60x60x114.3	3.5	90	1:2.0	0.17	Single-/3-phase 200 to 230 VAC	PBA2P603-C20	PBM603FGGK30-M	PB4A002P301			p. 28	p. 31	
	60x60x114.3	4	60	1:3.0	0.17	Single-phase 100 to 115 VAC	PBA1P603-C30	PBM603FGJK30-M	PB4A002P300			p. 28	p. 31	
	60x60x114.3	4	60	1:3.0	0.17	Single-/3-phase 200 to 230 VAC	PBA2P603-C30	PBM603FGJK30-M	PB4A002P301			p. 28	p. 31	
42x42x95.1	2.2 (4.5)	116	1:3.0	—	—	Single-phase 100 to 115 VAC	PBA1P423-H30	PBM423FHJK30-M	PB4A002P300	Power cable (1 m): PBC8P0010A		p. 29	p. 32	
42x42x95.1	2.2 (4.5)	116	1:3.0	—	—	Single-/3-phase 200 to 230 VAC	PBA2P423-H30	PBM423FHJK30-M	PB4A002P301			p. 29	p. 32	
42x42x95.1	3.5 (8.3)	70	1:5.0	—	—	Single-phase 100 to 115 VAC	PBA1P423-H50	PBM423FHJK30-M	PB4A002P300			p. 29	p. 32	
42x42x95.1	3.5 (8.3)	70	1:5.0	—	—	Single-/3-phase 200 to 230 VAC	PBA2P423-H50	PBM423FHJK30-M	PB4A002P301			p. 29	p. 32	
42x42x95.1	5 (11)	35	1:1.00	—	—	Single-phase 100 to 115 VAC	PBA1P423-H100	PBM423FHMK30-M	PB4A002P300			p. 29	p. 32	
42x42x95.1	5 (11)	35	1:1.00	—	—	Single-/3-phase 200 to 230 VAC	PBA2P423-H100	PBM423FHMK30-M	PB4A002P301			p. 29	p. 32	
60x60x135.8	5.5 (14)	70	1:5.0	—	—	Single-phase 100 to 115 VAC	PBA1P603-H50	PBM603FHJK30-M	PB4A002P300			I/O Signal Cable (1 m, shielded): PBC5S0010C	p. 29	p. 32
60x60x135.8	5.5 (14)	70	1:5.0	—	—	Single-/3-phase 200 to 230 VAC	PBA2P603-H50	PBM603FHJK30-M	PB4A002P301				p. 29	p. 32
60x60x135.8	8 (20)	35	1:1.00	—	—	Single-phase 100 to 115 VAC	PBA1P603-H100	PBM603FHMK30-M	PB4A002P300				p. 29	p. 32
60x60x135.8	8 (20)	35	1:1.00	—	—	Single-/3-phase 200 to 230 VAC	PBA2P603-H100	PBM603FHMK30-M	PB4A002P301				p. 29	p. 32
42x42x88.3	0.35	—	—	—	—	Single-phase 100 to 115 VAC	PBA1P423-B	PBM423FCK30-M	PB4A002P300		Power cable (1 m): PBC8P0010A		p. 30	p. 32
42x42x88.3	0.35	—	—	—	—	Single-/3-phase 200 to 230 VAC	PBA2P423-B	PBM423FCK30-M	PB4A002P301				p. 30	p. 32
60x60x108.1	1.3	—	—	—	—	Single-phase 100 to 115 VAC	PBA1P603-B	PBM603FCK30-M	PB4A002P300		I/O Signal Cable (1 m, shielded): PBC5S0010C		p. 30	p. 32
60x60x108.1	1.3	—	—	—	—	Single-/3-phase 200 to 230 VAC	PBA2P603-B	PBM603FCK30-M	PB4A002P301				p. 30	p. 32
60x60x140.1	1.9	—	—	—	—	Single-phase 100 to 115 VAC	PBA1P604-B	PBM604FCK30-M	PB4A002P300			p. 30	p. 32	
60x60x140.1	1.9	—	—	—	—	Single-/3-phase 200 to 230 VAC	PBA2P604-B	PBM604FCK30-M	PB4A002P301			p. 30	p. 32	

* Numbers in parenthesis following allowable torques indicate allowable instantaneous torques.

Options and Peripherals

Product names	Standard model number (length)	Connector set model number	Extendable max. length	Remarks	Page
① Power cable	PBC8P0010A (1 m)	PBC8P0000A	3 m	—	p. 87
② Motor extension cable	PBC7M0030A (3 m)	PBC7M0000A	20 m	An extension cable is required when the distance between the motor and driver exceeds 50 cm.	p. 87
③ Encoder extension cable	PBC7E0030A (3 m)	PBC7E0000A	20 m	An extension cable is required when the distance between the motor and driver exceeds 50 cm.	p. 87
④ I/O signal cable (shielded)	PBC5S0010C (1 m)	PBC5S0000A	2 m	—	p. 88
⑤ Limit input cable	PBC7S0010A (1 m)	PBC7S0000A	2 m	External limit sensor input	p. 88
⑥ Communications converter unit	PBFM-U6	—	—	A set of a converter (USB/RS-485) and a cable	p. 86
⑦ PC interface software	SPBALL-01	—	—	Software for checking operation and parameter setting	p. 86

AC Input Set Models
 Type R
 AC Input Set Models
 Type P
 DC Input Set Models
 Type M
 DC Input Drivers / Motors
 Type P Multi-axis
 DC Input Drivers / Motors
 Type E Multi-axis EtherCAT interface
 Options

Driver Dimensions Unit: mm

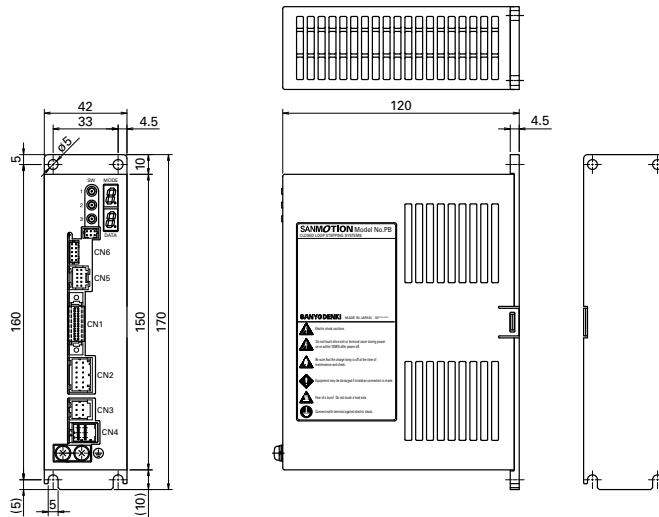

Driver Specifications

General specifications

		PB4A002P300	PB4A002P301	
Basic specifications	Model number	PB4A002P300	PB4A002P301	
	Interface	Pulse train input		
	Input power supply	Single-phase 100 to 115 VAC (-15%, +10%) 50/60 Hz Single-phase 200 to 230 VAC (-15%, +10%) 50/60 Hz 3-phase 200 to 230 VAC (-15%, +10%) 50/60 Hz		
	Control method	PWM control: Sinusoidal drive method		
	Power supply current	6 A	4.5 A	2.5 A
	Environment	Protection class	Class I	
		Operation environment	Installation category (overvoltage category): II, Pollution degree: 2	
		Operating ambient temperature	0 to +55°C	
		Storage temperature	-20 to +65°C	
		Operating ambient humidity	90% RH max. (non-condensing)	
		Storage humidity	90% RH max. (non-condensing)	
		Operation altitude	1000 m or less above sea level	
Vibration resistance		Tested under the following conditions: Acceleration: 5 m/s ² , Frequency range: 10 to 55 Hz, Axes of vibration: X, Y, Z (2 hours each)		
Impact resistance	20 m/s ²			
Dielectric strength	No error observed when 1.5 kVAC is applied between power input terminal and frame for one minute.			
Insulation resistance	10 MΩ min. when measured with a 500 VDC megohmmeter between input terminal and frame.			
Mass	0.65 kg			
Functions	Rotational speed	0 to 4500 min ⁻¹ (0 to 4000 min ⁻¹ for 86 mm sq. motors)		
	Command resolution (P/R)	500, 1000, 2000, 4000, 5000, 10000, 16000, 32000		
	Holding brake control function	Built in		
	Protection functions	Power voltage error, regenerative voltage error, driver overheat, motor overheat, overload stop, positional deviation error, servo error, homing mode error, command pulse error, overcurrent, wrap around, push operation error, encoder disconnection, initialization error, nonvolatile memory error		
	Display / Indication	7-segment LED display (2)		
	Digital operator	Resolution, pulse input type, applicable motor, forward direction definition, gain, FF gain, S-shape filter, Jog operation		
	Operating functions	Auto homing mode operation / Push (current control) operation / S-shape operation function		
PC interface	RS-485 Start / stop synchronization, half-duplex communication Baud rate: 115200 bps			
I/O signal	Input signal	Function	Pulse input, STOP, ALMCLR General-purpose input×2 (select from Deviation clear, HOME, Push, Brake control, and Counter reset)	
		Electrical specifications	Pulse input: Line receiver 1 or 2 input type General-purpose input: Bidirectional input photocoupler 5 to 24 VDC	
	Output signal	Function	Encoder signal (A/B/Z) ALM, In-Position General-purpose output×2 (select from HOME END, Push END, ZONE, and input monitor)	
		Electrical specifications	Pulse signal output: Line driver 4000 P/R * Z-phase / phase origin signal is only output at 200 mm ⁻¹ or less. General-purpose output: Open collector 30 VDC, 15 mA or less	

* A function that finely adjusts the unit step angle per pulse parameters. Setup software is required.

Safety standards

	Directives	Standard	
CE (TÜV)	Low-voltage directives	EN 61800-5-1	
	EMC directives	EN 61800-3 EN 61000-6-2	
	Acquired standards	Applicable standard	File no.
UL	UL	UL 508C	E179775
	cUL		

External Wiring Diagram

Single-phase 100 to 115 VAC Driver model number: PB4A002P300

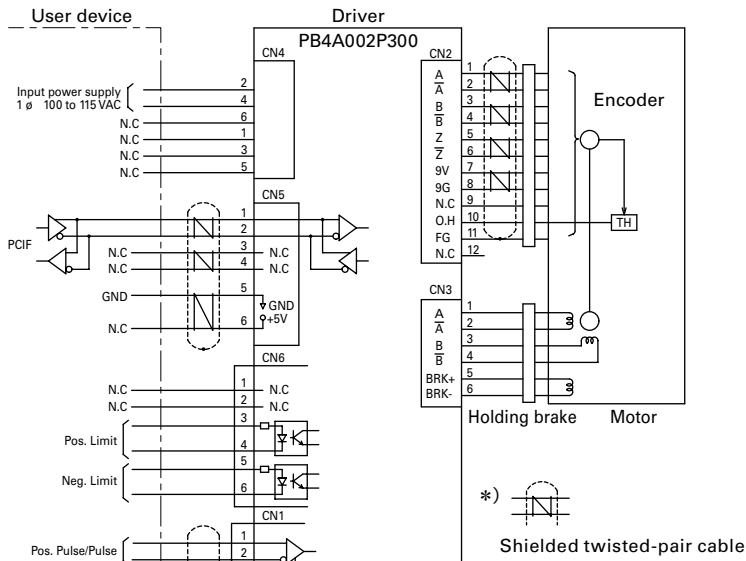

Single-/3-phase 200 to 230 VAC Driver model number: PB4A002P301

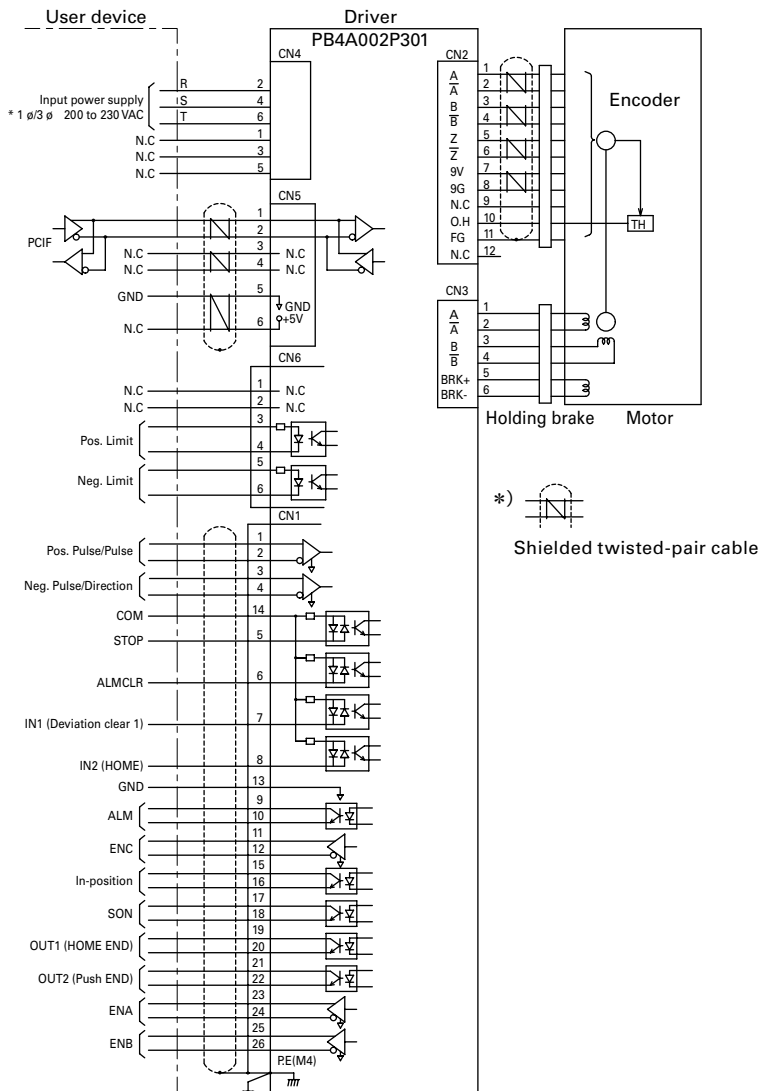

● Functions for IN1, IN2, OUT1, and OUT2 are assigned with PC interface.
 * When using with single-phase power supply, wire to pins 2 and 4.

Wiring

Connector Models and Compatible Cables

Application	Connector no.	Description	Manufacturer model number	Compatible cables	Maximum extension length	Manufacturer
I/O signals	CN1	Plug (driver side)	8830E-026-170LD-F	AWG28 (7/0.127)	2 m	KEL CORPORATION
		Receptacle	8822E-026-171D			
Encoder	CN2	Tab header (driver side)	1-1827876-6	AWG22 to 28 Shielded twisted pair *The contact model number varies with diameter over outer shield.	20 m	Tyco Electronics Japan G.K.
		Receptacle housing	1-1827864-6			
		Receptacle contact	1827569-2 (AWG28 to 30) 1827570-2 (AWG22 to 28)			
		Tab housing (for relay)	1-1903130-6			
		Tab contact (for relay)	1903111-2 (AWG28 to 30) 1903112-2 (AWG22 to 28)			
Motor	CN3	Tab header (driver side)	1-1827876-3	AWG18 to 22 Discrete line *The contact model number varies with diameter over outer shield.	20 m	Tyco Electronics Japan G.K.
		Receptacle housing	1-1827864-3			
		Receptacle contact	1827570-2 (AWG22 to 28) 1827572-2 (AWG18 to 22)			
		Tab housing (for relay)	1-1903130-3			
		Tab contact (for relay)	1903112-2 (AWG22 to 28) 1903114-2 (AWG18 to 22)			
Power supply	CN4	Tab header (driver side)	1376136-1	AWG18 Discrete line	2 m	Tyco Electronics Japan G.K.
		Receptacle housing	1-1318119-3			
		Receptacle contact	1318107-1 (single) 1318105-1 (linked)			
Communications	CN5	Post with base (driver side)	S10B-PADSS-1GW	AWG28 to 24 Shielded twisted pair	2 m	J.S.T.
		Housing	PADP-10V-1-S			
		Contact	SPH-002T-P0.5L			
Limit signal input	CN6	Pin header	DF11-10DP-2DS (52)	AWG22	2 m	Hirose Electric
		Socket	DF11-10DS-2C			
		Contact	DF11-22SCA (loose)			

- Refer to the manufacturer's catalog for detailed connector specifications.
- If the maximum extended length is exceeded, take necessary countermeasures to prevent malfunctions due to line noise.
- The relay connector is used to connect to the motor or encoder side connector when creating an extension cable.

Driver Components and Functions

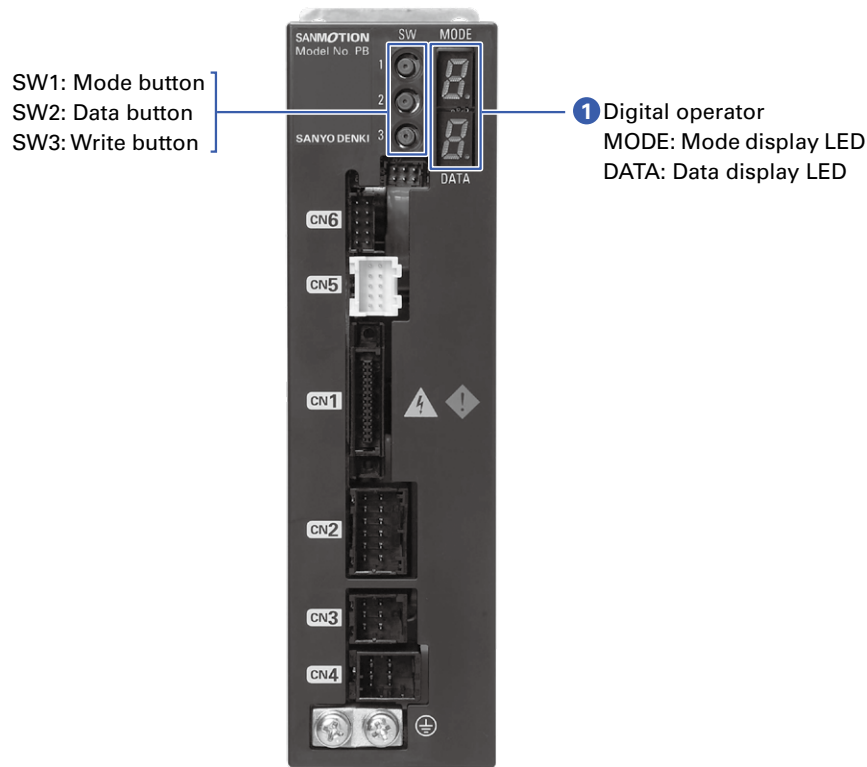

1 Digital operator
Used to set parameters and perform Jog operations.

■ Display

- **MODE (Mode display LED)**
Displays the current mode number.
- **DATA (Data display LED)**
Displays monitor and parameter setting values.
Blinks when the displayed parameter setting value is different from the current setting value.

■ Button

- **SW1 (Mode button)**
Mode numbers switch sequentially each time the button is pressed.
However, the mode number 9 is only displayed when the servo is ON.
- **SW2 (Data button)**
The function varies with mode number.
- **SW3 (Write button)**
The function varies with mode number.

■ Functions

MODE	Functions	Data range (DATA display)	SW2 Functions	SW3 Functions
0	Driver status display (See table 1.)		Disabled	Disabled
1	Pulse input method setting	0 = 2 input type, 1 = 1 input type	Switches set values	Writes set values
2	Motor selection	0 to 6 (See table 2.)	Switches set values	Writes set values
3	Resolution selection	0 to 7 (See table 3.)	Switches set values	Writes set values
4	Forward direction setting	0 = CW is forward, 1 = CCW is forward	Switches set values	Writes set values
5	Speed loop gain setting	0 to F	Switches set values	Writes set values
6	Feed forward gain setting	0 to F (10 h/LSB)	Switches set values	Writes set values
7	S-shape filter setting	0 to F	Switches set values	Writes set values
8	Jog operation speed	1 to F (100 min'/LSB)	Switches set values	Writes set values
9	Jog operation	-	Forward direction operation	Reverse direction operation

- Changed values for modes 1 to 4 are enabled upon restart.
- Changed values for modes 5 to 8 are enabled immediately.
- The mode number switches to 9 only when the servo is ON.

Table 1 Driver status and corresponding DATA parameters when MODE parameter is 0.

Displayed data	Driver status	Displayed data	Driver status
0	Servo OFF	9	Homing mode error
Figure-8 pattern	Servo ON	A	Command pulse error
1	Low voltage error	b	Overcurrent (motor winding detection)
2	Overvoltage error	C	Wrap around
3	Regenerative voltage error	d	Push operation error
4	Driver overheat error	E	Encoder disconnection error
5	Motor overheat error	F	Initialization error
6	Overload stop error	H	Overcurrent (bus current detection)
7	Positional deviation error	L	Nonvolatile memory error
8	Servo error		

Table 2 Motor selection

Set value	Motor model number	Set value	Motor model number
0	PBM423	4	PBM604
1	PBM503	5	PBM861
2	PBM565	6	PBM862
3	PBM603		

Table 3 Resolution selection (P/R)

Set value	Resolution	Set value	Resolution
0	500	4	5000
1	1000	5	10000
2	2000	6	16000
3	4000	7	32000

- Electronic gear ratios are set automatically.

Standard model

RoHS

Size	Motor size	42 mm sq.			60 mm sq.			86 mm sq.					
	Motor length	55.9 mm			68.8 mm			79.5 mm		110 mm			
Motor model number		PBM423FXK30-M			PBM603FXK30-M			PBM604FXK30-M		PBM861FXK30-M		PBM862FXK30-M	
Type R set model number		PBA1R423			PBA1R603			PBA1R604		PBA1R861		PBA1R862	
Compatible driver model number		PB4A002R300			PB4A002R300			PB4A002R300		PB4A002R300		PB4A002R300	
Type P set model number		PBA2R423			PBA2R603			PBA2R604		PBA2R861		PBA2R862	
Compatible driver model number		PB4A002R301			PB4A002R301			PB4A002R301		PB4A002R301		PB4A002R301	
Type P set model number		PBA1P423			PBA1P603			PBA1P604		PBA1P861		PBA1P862	
Compatible driver model number		PB4A002P300			PB4A002P300			PB4A002P300		PB4A002P300		PB4A002P300	
Type P set model number		PBA2P423			PBA2P603			PBA2P604		PBA2P861		PBA2P862	
Compatible driver model number		PB4A002P301			PB4A002P301			PB4A002P301		PB4A002P301		PB4A002P301	
Max. stall torque	N·m	0.35			1.3			1.9		3.1		6.1	
Rotor inertia	$\times 10^{-4}$ kg·m ²	0.056			0.4			0.84		1.48		3	
Allowable thrust load	N	9.8			14.7			14.7		60		60	
Allowable radial load *	N	47			190			190		200		200	
Motor mass	kg	0.35			0.85			1.42		1.9		3.1	
Characteristics diagram		①			②			③		④		⑤	

① Maintain motor surface temperature at 85°C or lower while in use.

* The load point is at the end of the output shaft.

Characteristics diagram

Torque 100 VAC/200 VAC — Power supply current Single-phase 100 VAC — Single-phase 200 VAC - - - 3-phase 200 VAC ·····

① Motor model number **PBM423FXK30-M**

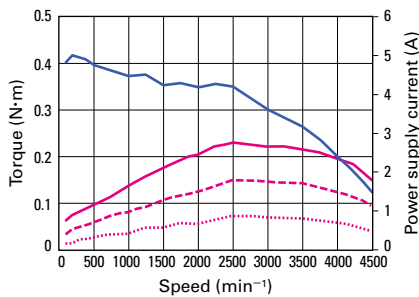

② Motor model number **PBM603FXK30-M**

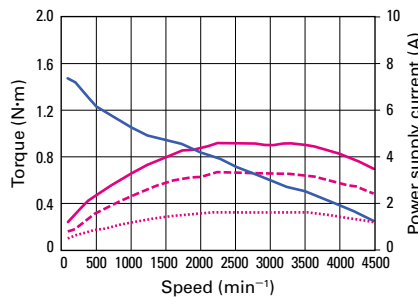

③ Motor model number **PBM604FXK30-M**

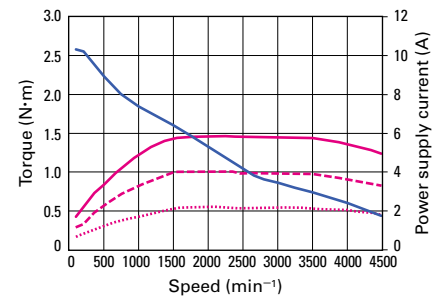

④ Motor model number **PBM861FXK30-M**

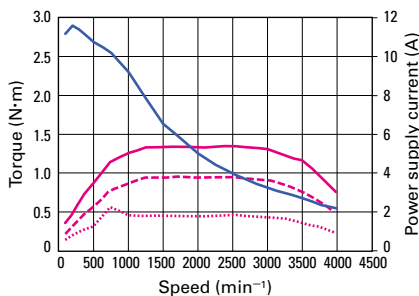

⑤ Motor model number **PBM862FXK30-M**

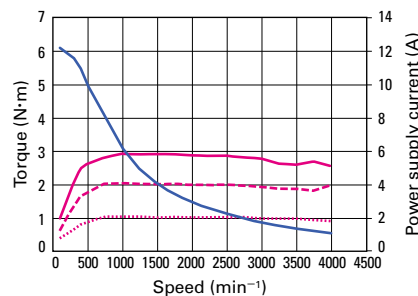

Size	Motor size	42 mm sq.				
	Motor + gear length	86.1 mm				
Motor model number		PBM423FGAK30-M	PBM423FGBK30-M	PBM423FGEK30-M	PBM423FGGK30-M	PBM423FGJK30-M
Type R set model number		PBA1R423-C3.6	PBA1R423-C7.2	PBA1R423-C10	PBA1R423-C20	PBA1R423-C30
Compatible driver model number		PB4A002R300	PB4A002R300	PB4A002R300	PB4A002R300	PB4A002R300
Type R set model number		PBA2R423-C3.6	PBA2R423-C7.2	PBA2R423-C10	PBA2R423-C20	PBA2R423-C30
Compatible driver model number		PB4A002R301	PB4A002R301	PB4A002R301	PB4A002R301	PB4A002R301
Type P set model number		PBA1P423-C3.6	PBA1P423-C7.2	PBA1P423-C10	PBA1P423-C20	PBA1P423-C30
Compatible driver model number		PB4A002P300	PB4A002P300	PB4A002P300	PB4A002P300	PB4A002P300
Type P set model number		PBA2P423-C3.6	PBA2P423-C7.2	PBA2P423-C10	PBA2P423-C20	PBA2P423-C30
Compatible driver model number		PB4A002P301	PB4A002P301	PB4A002P301	PB4A002P301	PB4A002P301
Allowable torque	N·m	0.343	0.686	0.98	1.47	1.47
Rotor inertia	$\times 10^{-4}$ kg·m ²	0.056	0.056	0.056	0.056	0.056
Gear ratio	—	1:3.6	1:7.2	1:10	1:20	1:30
Backlash	deg. or less	0.6	0.4	0.35	0.25	0.25
Allowable speed	min ⁻¹	500	250	180	90	60
Rotation direction	Relative to command direction	Forward	Forward	Forward	Reverse	Reverse
Allowable thrust load	N	15	15	15	15	15
Allowable radial load *	N	20	20	20	20	20
Motor mass	kg	0.48	0.48	0.48	0.48	0.48
Characteristics diagram		①	②	③	④	⑤

● Maintain motor surface temperature at 85°C or lower while in use.
 * When load is applied at 1/3 length from output shaft end.

Characteristics diagram

Allowable torque 100 VAC/200 VAC — Power supply current Single-phase 100 VAC — Single-phase 200 VAC - - - 3-phase 200 VAC ·····

① Motor model number **PBM423FGAK30-M**

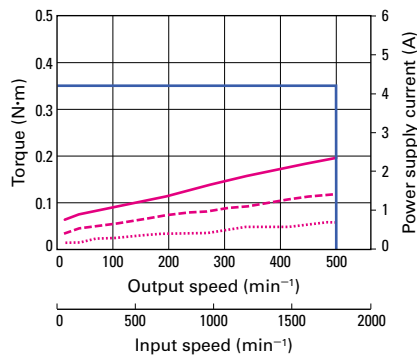

② Motor model number **PBM423FGBK30-M**

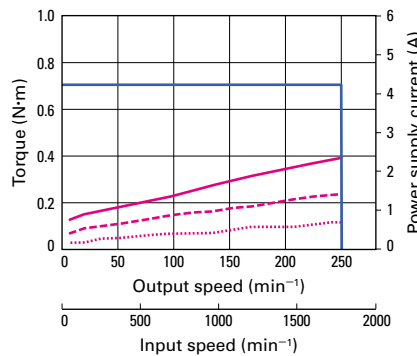

③ Motor model number **PBM423FGEK30-M**

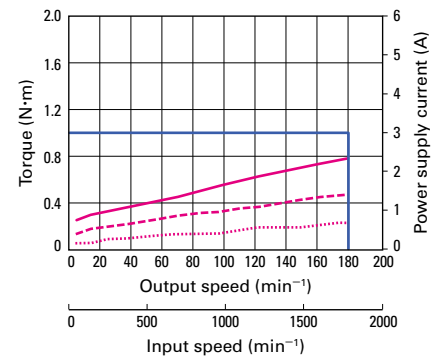

④ Motor model number **PBM423FGGK30-M**

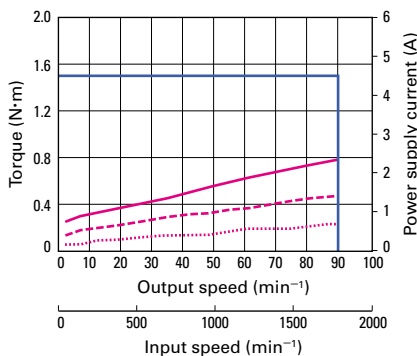

⑤ Motor model number **PBM423FGJK30-M**

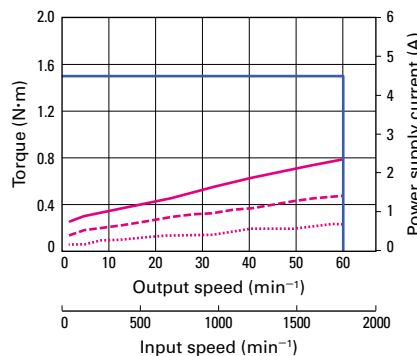

System Configuration Diagram ▶ pp. 14, 20 Set Model Configurations ▶ pp. 15, 21 Driver Dimensions ▶ pp. 16, 22 Motor Dimensions ▶ pp. 31 to 32

When using a motor with low-backlash gear, exceeding the allowable torque might damage the gear. Carefully select products so that the configured system can operate within the specified limit value.

● Data for the above characteristics is based on SANYO DENKI's internal measurement conditions. Depending on conditions such as machine precision, driving torque may vary as well.

Low-backlash gear model

RoHS

Size	Motor size	60 mm sq.				
	Motor + gear length	114.3 mm				
Motor model number		PBM603FGAK30-M	PBM603FGBK30-M	PBM603FGEK30-M	PBM603FGGK30-M	PBM603FGJK30-M
Type R set model number		PBA1R603-C3.6	PBA1R603-C7.2	PBA1R603-C10	PBA1R603-C20	PBA1R603-C30
Compatible driver model number		PB4A002R300	PB4A002R300	PB4A002R300	PB4A002R300	PB4A002R300
Type P set model number		PBA2R603-C3.6	PBA2R603-C7.2	PBA2R603-C10	PBA2R603-C20	PBA2R603-C30
Compatible driver model number		PB4A002R301	PB4A002R301	PB4A002R301	PB4A002R301	PB4A002R301
Type P set model number		PBA1P603-C3.6	PBA1P603-C7.2	PBA1P603-C10	PBA1P603-C20	PBA1P603-C30
Compatible driver model number		PB4A002P300	PB4A002P300	PB4A002P300	PB4A002P300	PB4A002P300
Type P set model number		PBA2P603-C3.6	PBA2P603-C7.2	PBA2P603-C10	PBA2P603-C20	PBA2P603-C30
Compatible driver model number		PB4A002P301	PB4A002P301	PB4A002P301	PB4A002P301	PB4A002P301
Allowable torque	N·m	1.25	2.5	3	3.5	4
Rotor inertia	$\times 10^{-4}$ kg·m ²	0.4	0.4	0.4	0.4	0.4
Gear ratio	—	1:3.6	1:7.2	1:10	1:20	1:30
Backlash	deg. or less	0.55	0.25	0.25	0.17	0.17
Allowable speed	min ⁻¹	500	250	180	90	60
Rotation direction	Relative to command direction	Forward	Forward	Reverse	Reverse	Reverse
Allowable thrust load	N	30	30	30	30	30
Allowable radial load *	N	100	100	100	100	100
Motor mass	kg	1.22	1.22	1.22	1.22	1.22
Characteristics diagram		①	②	③	④	⑤

● Maintain motor surface temperature at 85°C or lower while in use.
* When load is applied at 1/3 length from output shaft end.

Characteristics diagram

Allowable torque 100 VAC/200 VAC — Power supply current Single-phase 100 VAC — Single-phase 200 VAC - - - 3-phase 200 VAC ·····

① Motor model number **PBM603FGAK30-M**

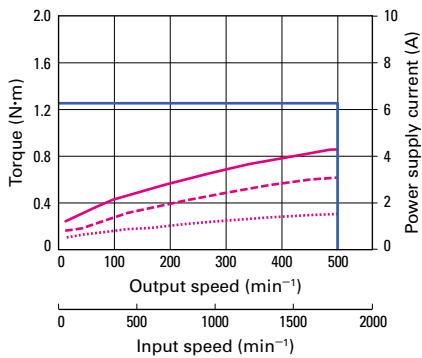

② Motor model number **PBM603FGBK30-M**

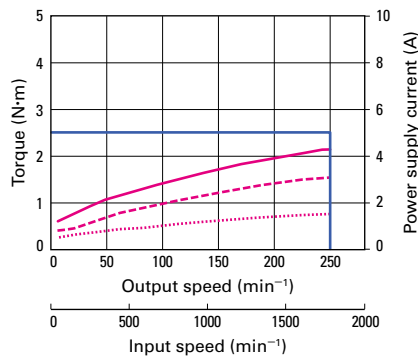

③ Motor model number **PBM603FGEK30-M**

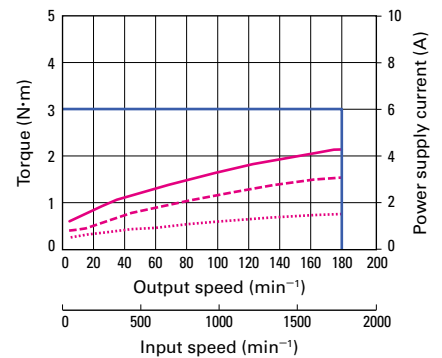

④ Motor model number **PBM603FGGK30-M**

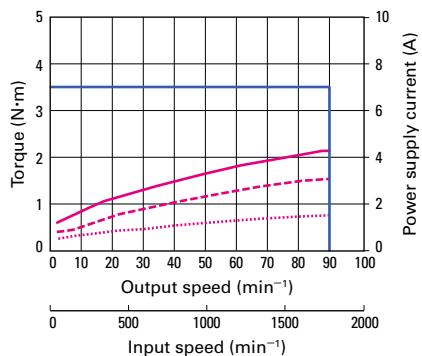

⑤ Motor model number **PBM603FGJK30-M**

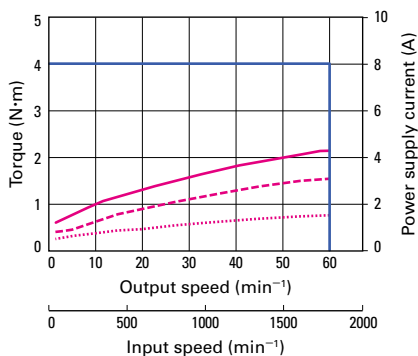

System Configuration Diagram ▶ pp. 14, 20 Set Model Configurations ▶ pp. 15, 21 Driver Dimensions ▶ pp. 16, 22 Motor Dimensions ▶ pp. 31 to 32

When using a motor with low-backlash gear, exceeding the allowable torque might damage the gear. Carefully select products so that the configured system can operate within the specified limit value.

● Data for the above characteristics is based on SANYO DENKI's internal measurement conditions. Depending on conditions such as machine precision, driving torque may vary as well.

Size	Motor size	42 mm sq.			60 mm sq.	
	Motor + gear length	95.1 mm			135.8 mm	
Motor model number		PBM423FHJK30-M	PBM423FHLK30-M	PBM423FHMK30-M	PBM603FHLK30-M	PBM603FHMK30-M
Type R set model number		PBA1R423-H30	PBA1R423-H50	PBA1R423-H100	PBA1R603-H50	PBA1R603-H100
Compatible driver model number		PB4A002R300	PB4A002R300	PB4A002R300	PB4A002R300	PB4A002R300
Type R set model number		PBA2R423-H30	PBA2R423-H50	PBA2R423-H100	PBA2R603-H50	PBA2R603-H100
Compatible driver model number		PB4A002R301	PB4A002R301	PB4A002R301	PB4A002R301	PB4A002R301
Type P set model number		PBA1P423-H30	PBA1P423-H50	PBA1P423-H100	PBA1P603-H50	PBA1P603-H100
Compatible driver model number		PB4A002P300	PB4A002P300	PB4A002P300	PB4A002P300	PB4A002P300
Type P set model number		PBA2P423-H30	PBA2P423-H50	PBA2P423-H100	PBA2P603-H50	PBA2P603-H100
Compatible driver model number		PB4A002P301	PB4A002P301	PB4A002P301	PB4A002P301	PB4A002P301
Allowable torque	N·m	2.2	3.5	5	5.5	8
Allowable instantaneous torque	N·m	4.5	8.3	11	14	20
Rotor inertia	×10 ⁻⁴ kg·m ²	0.068	0.068	0.068	0.435	0.435
Gear ratio	—	1:30	1:50	1:100	1:50	1:100
Hysteresis loss	Arc min or less	3.6	2.4	2.4	—	—
Lost motion	Arc min	—	—	—	0.4 to 3 (at ±0.28 N·m)	0.4 to 1.5 (at ±0.4 N·m)
Allowable speed	min ⁻¹	116	70	35	70	35
Rotation direction	Relative to command direction	Reverse	Reverse	Reverse	Reverse	Reverse
Allowable thrust load	N	1150	1150	1150	400	400
Allowable radial load *	N	275	275	275	360	360
Motor mass	kg	0.54	0.54	0.54	1.45	1.45
Characteristics diagram		①	②	③	④	⑤

● Maintain motor surface temperature at 85°C or lower while in use.
* When load is applied at 1/3 length from output shaft end.

Characteristics diagram

Allowable torque Single-phase 100 VAC, Single/3-phase 200 VAC ——— Allowable instantaneous torque Single-phase 100 VAC, Single/3-phase 200 VAC - - - - -
Power supply current Single-phase 100 VAC ——— Single-phase 200 VAC - - - - - 3-phase 200 VAC ······

① Motor model number **PBM423FHJK30-M**

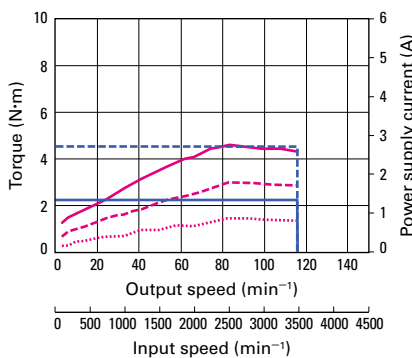

② Motor model number **PBM423FHLK30-M**

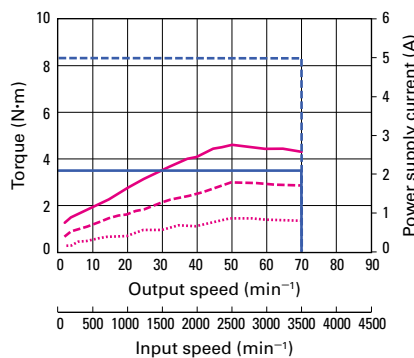

③ Motor model number **PBM423FHMK30-M**

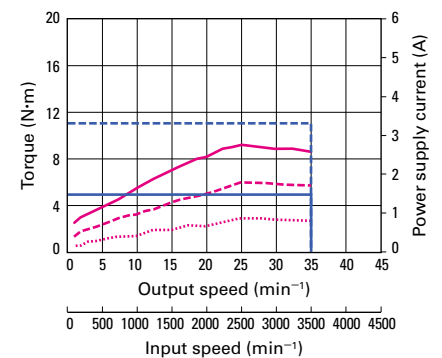

④ Motor model number **PBM603FHLK30-M**

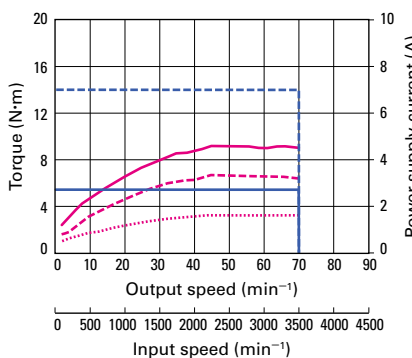

⑤ Motor model number **PBM603FHMK30-M**

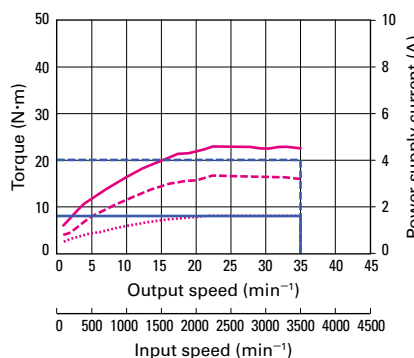

System Configuration Diagram ▶ pp. 14, 20 Set Model Configurations ▶ pp. 15, 21 Driver Dimensions ▶ pp. 16, 22 Motor Dimensions ▶ pp. 31 to 32

When using a motor with harmonic gear, exceeding the allowable instantaneous torque might damage the gear. Carefully select products so that the configured system can operate within the specified limit value.
● Data for the above characteristics is based on SANYO DENKI's internal measurement conditions. Depending on conditions such as machine precision, driving torque may vary as well.

Electromagnetic brake model

RoHS

Size	Motor size		42 mm sq.			60 mm sq.					
	Motor size	Motor + brake length	88.3 mm			108.1 mm			140.1 mm		
Motor model number			PBM423FCK30-M			PBM603FCK30-M			PBM604FCK30-M		
Type R set model number			PBA1R423-B			PBA1R603-B			PBA1R604-B		
Compatible driver model number			PB4A002R300			PB4A002R300			PB4A002R300		
Type R set model number			PBA2R423-B			PBA2R603-B			PBA2R604-B		
Compatible driver model number			PB4A002R301			PB4A002R301			PB4A002R301		
Type P set model number			PBA1P423-B			PBA1P603-B			PBA1P604-B		
Compatible driver model number			PB4A002P300			PB4A002P300			PB4A002P300		
Type P set model number			PBA2P423-B			PBA2P603-B			PBA2P604-B		
Compatible driver model number			PB4A002P301			PB4A002P301			PB4A002P301		
Max. stall torque	N·m		0.35			1.3			1.9		
Rotor inertia	$\times 10^{-4}$ kg·m ²		0.071			0.559			1.0		
Allowable thrust load	N		9.8			14.7			14.7		
Allowable radial load *	N		47			190			190		
Motor mass	kg		0.5			1.19			1.76		
Electromagnetic brake	Brake type	—	No excitation actuating type			No excitation actuating type			No excitation actuating type		
	Power supply voltage	V	24 VDC \pm 5%			24 VDC \pm 5%			24 VDC \pm 5%		
	Excitation current	A	0.1			0.25			0.25		
	Power consumption	W	2.4 (at 75°C)			6 (at 75°C)			6 (at 75°C)		
	Static friction torque	N·m or over	0.3			0.8			0.8		
	Brake operating time	ms or less	20			20			20		
Brake release time	ms or less	30			30			30			
Characteristics diagram			①			②			③		

● Maintain motor surface temperature at 85°C or lower while in use.

* The load point is at the end of the output shaft.

Characteristics diagram

Torque 100 VAC/200 VAC — Power supply current Single-phase 100 VAC — Single-phase 200 VAC - - - 3-phase 200 VAC ·····

① Motor model number **PBM423FCK30-M**

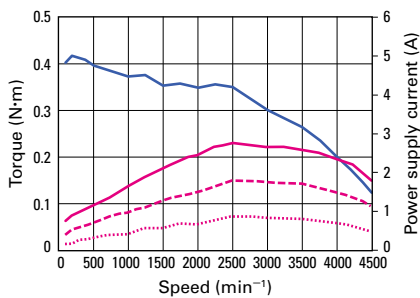

② Motor model number **PBM603FCK30-M**

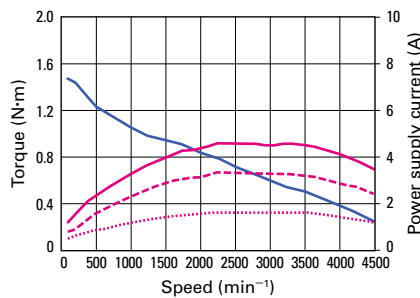

③ Motor model number **PBM604FCK30-M**

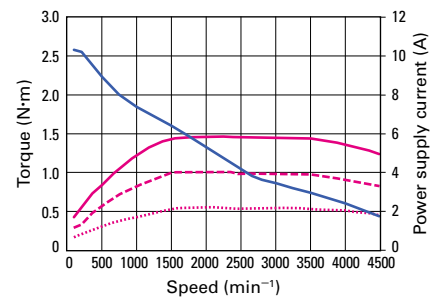

System Configuration Diagram ▶ pp. 14, 20 Set Model Configurations ▶ pp. 15, 21 Driver Dimensions ▶ pp. 16, 22 Motor Dimensions ▶ pp. 31 to 32

The electromagnetic brake only works when the motor is stopped, and cannot be used for braking.

● Data for the above characteristics is based on SANYO DENKI's internal measurement conditions. Depending on conditions such as machine precision, driving torque may vary as well.

Motor Dimensions Unit: mm

Standard model

42 mm sq.

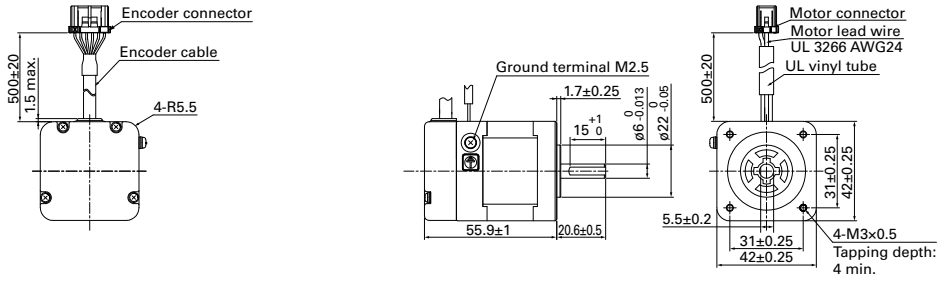

60 mm sq.

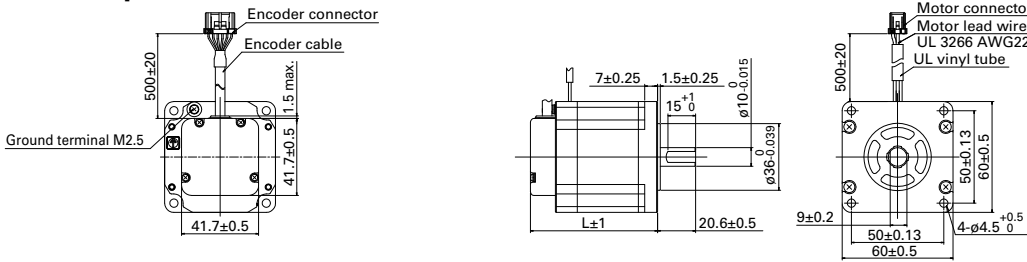

Motor model number	Motor length (L)
PBM603FXK30-M	68.8
PBM604FXK30-M	100.8

86 mm sq.

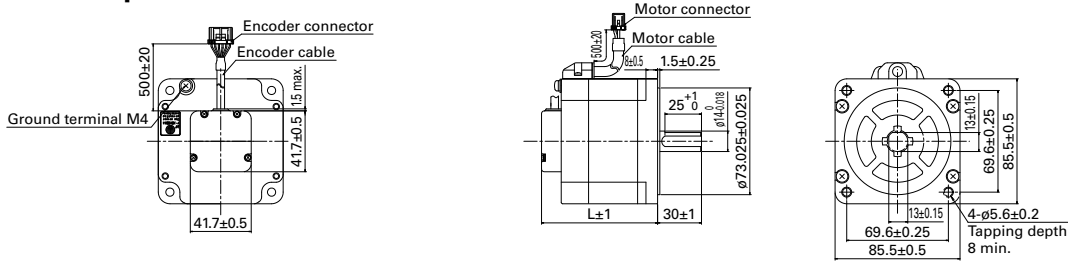

Motor model number	Motor length (L)
PBM861FXK30-M	79.5
PBM862FXK30-M	110

Low-backlash gear model

42 mm sq.

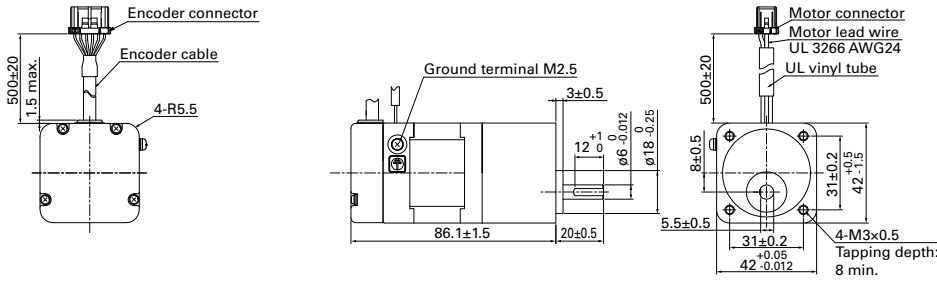

60 mm sq.

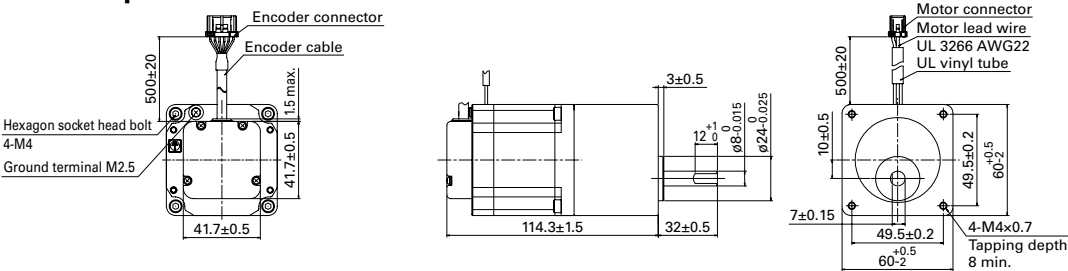

Motor Dimensions Unit: mm

Harmonic gear model

42 mm sq.

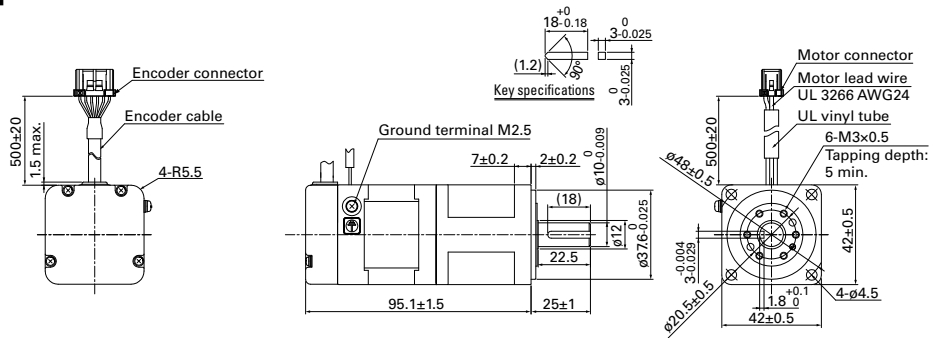

60 mm sq.

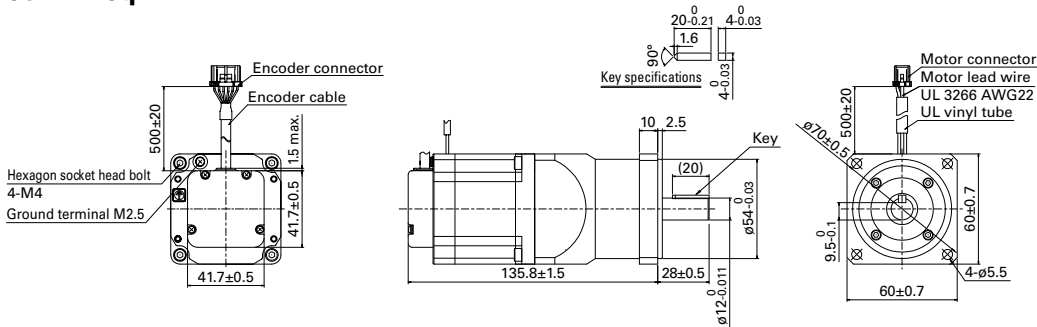

Electromagnetic brake model

42 mm sq.

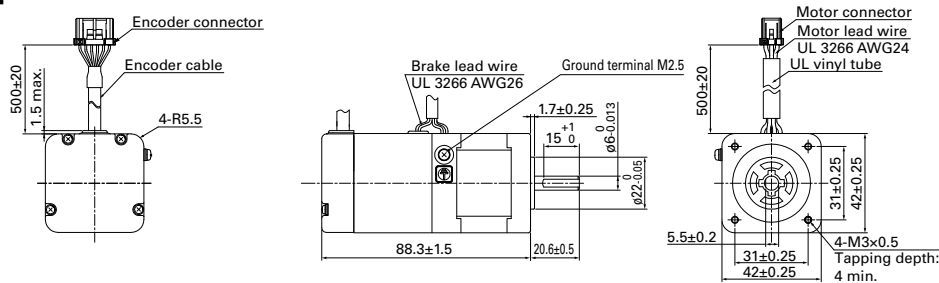

60 mm sq.

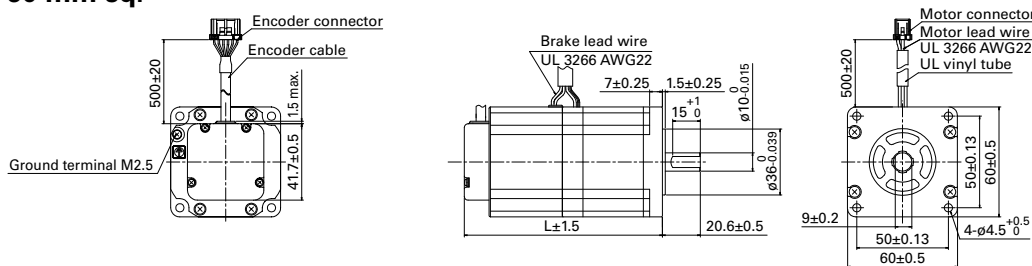

Motor model number	Motor length (L)
PBM603FCK30-M	108.1
PBM604FCK30-M	140.1

Connector specifications

Encoder connector

Housing: 1827864-6
Terminal: 1827569-2
Manufacturer: Tyco Electronics Japan G.K.

Motor connector

Housing: 1827864-3
Terminal: 1827570-2
Manufacturer: Tyco Electronics Japan G.K.

Motor Specifications

General specifications

Motor model number	PBM423F□K	PBM60□F□K	PBM86□F□K
Type	S1 (continuous operation)		
Operating ambient temperature	-10 to +40°C (0 to +40°C for harmonic gear model)		
Storage ambient temperature	-20 to +60°C		
Operating ambient humidity	95% RH max.: Under 40°C		
Storage ambient humidity	95% RH max.: Under 40°C, 57% RH max.: Under 50°C, 35% RH max.: Under 60°C (non-condensing)		
Operation altitude	1000 m or less above sea level		
Vibration resistance	Tested with frequency 10 to 500 Hz, total amplitude 1.52 mm (10 to 70 Hz), acceleration 150 m/s ² (70 to 500 Hz), sweep time 15 min/cycle, 12 sweeps in each X, Y and Z direction.		
Impact resistance	Tested with 500 m/s ² of acceleration for 11 ms with half-sine wave applying three times for X, Y and Z axes each, 18 times in total.		
Thermal class	B (+130°C) (UL: A)	F (+155°C)	
Dielectric strength	At normal temperature and humidity, no failure with 1500 VAC at 50/60 Hz applied for one minute between motor winding and frame.		
Insulation resistance	At normal temperature and humidity, not less than 100 MΩ when measured with a 500 VDC megohmmeter between motor winding and frame.		
Protection grade	IP40		
Thrust play *	0.075 mm max. (load: 5 N)	0.075 mm max. (load: 10 N)	
Radial play **	0.025 mm max. (load: 5 N)		
Shaft runout	0.025 mm		
Concentricity of mounting pilot relative to shaft	ø0.075 mm		
Perpendicularity of mounting surface relative to shaft	0.1 mm	0.15 mm	
Motor mounting orientation	Can be mounted vertically or horizontally		
Encoder	Resolution	4000×4=16000 P/R	
	Number of channels	3 CH ***	
	Output method	Line driver (C-MOS)	
	Max. response frequency	300 kHz	
	Power supply voltage	8 to 10 VDC	
	Current consumption	70 mA max.	

● The user should not test the insulation resistance or insulation withstand voltage because capacitors are inserted into the encoder output ground line and the frame line to prevent noise.

● Take radiation and drive conditions into consideration to maintain motor surface temperature at 85°C or lower while in use.

* Thrust play: Displacement in shaft position in the axial direction when a load is applied to the motor shaft in the axial direction.

** Radial play: Displacement in shaft position in the radial direction when a load is applied in the vertical direction to the mounting surface of shaft at point 1/3 the shaft length from the end of the motor shaft.

*** The Z channel outputs 51 pulses. It is designed for use with drivers listed in this catalog.

Safety standards

CE (TÜV)	Directives	Applicable standard	
	Low-voltage directives (2006/95/EC)	EN 60034-1, EN 60034-5	
UL	Acquired standards	Applicable standard	File no.
	UL	UL 1004-1, UL 1004-6	E179832 (PRHZ2)
	cUL	CSA C22.2 No. 100	E179832 (PRHZ8)

DC Input Set Models

Type M Multi-input type (RS-485+Parallel I/O, Pulse Train Input selectable)



Set configuration items RoHS

Motor

Motor size: 28 mm sq., 42 mm sq., 60 mm sq.

Driver / Cable

Driver / cable set model number: PB3D003M200-S□

Set Model Configuration

Driver Model number: PB3D003M200-□ CE RoHS UL

Power cable (1 m) Model number: PBC6P0010A

I/O signal cable (1 m, shielded) Model number: PBC5S0010C

● DIP switches are used to select between RS-485+Parallel I/O and pulse train (Type M).

Set Model Configurations ▶ p. 35 Driver Dimensions ▶ p. 36

Driver Specifications ▶ p. 36 Specifications / Characteristics Diagram ▶ pp. 39 to 45

Motor Dimensions ▶ pp. 46 to 48 Motor Specifications ▶ p. 49

System Configuration Diagram

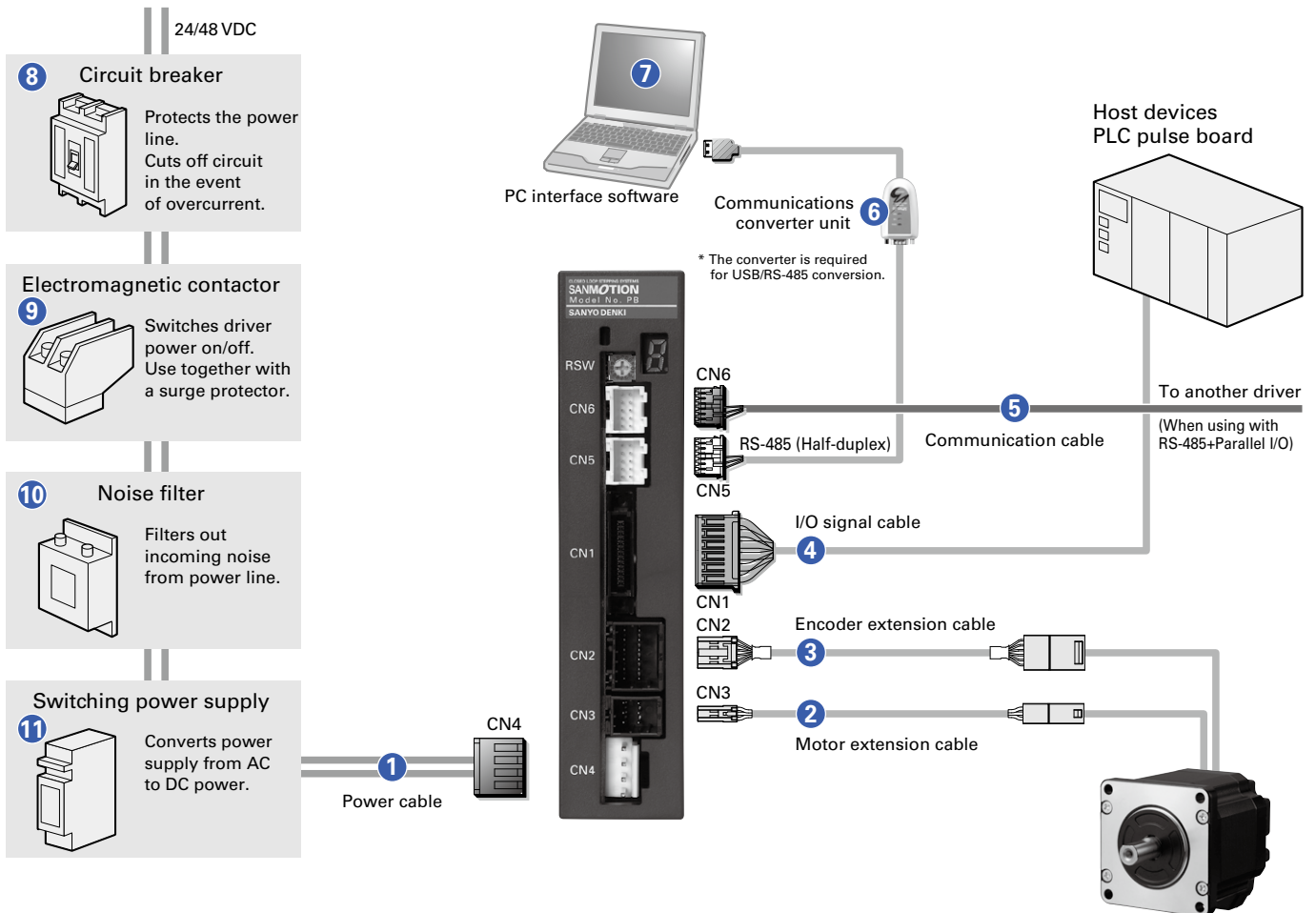

To be provided by the customer. 8 to 11

Set Model Configurations

Model	Motor external dimensions Flange size x Motor length (mm)	Max. stall torque (Allowable torque* for models with gear) (N·m)	Allowable speed (min ⁻¹)	Gear ratio	Backlash (deg.)	Set model	Set configuration items		Page	
							Motor model number	Driver / cable set model number A driver, power cable, and I/ O signal cable are included.	Specifications	Motor dimensions
Standard model	28×28×58.5	0.055	–	–	–	PBDM282	PBM282FXE20	PB3D003M200-S0	p. 39	p. 46
	28×28×77.8	0.155	–	–	–	PBDM284	PBM284FXE20	PB3D003M200-S1	p. 39	p. 46
	42×42×57.6	0.39	–	–	–	PBDM423	PBM423FXE20	PB3D003M200-S2	p. 39	p. 46
	60×60×70.3	1.3	–	–	–	PBDM603	PBM603FXE20	PB3D003M200-S3	p. 39	p. 46
	60×60×102.3	1.9	–	–	–	PBDM604	PBM604FXE20	PB3D003M200-S4	p. 39	p. 46
Low-backlash gear model	42×42×87.9	0.343	500	1:3.6	0.6	PBDM423-C3.6	PBM423FGAE20	PB3D003M200-S2	p. 40	p. 46
	42×42×87.9	0.686	250	1:7.2	0.4	PBDM423-C7.2	PBM423FGBE20	PB3D003M200-S2	p. 40	p. 46
	42×42×87.9	0.98	180	1:10	0.35	PBDM423-C10	PBM423FGEE20	PB3D003M200-S2	p. 40	p. 46
	42×42×87.9	1.47	90	1:20	0.25	PBDM423-C20	PBM423FGGE20	PB3D003M200-S2	p. 40	p. 46
	42×42×87.9	1.47	60	1:30	0.25	PBDM423-C30	PBM423FGJE20	PB3D003M200-S2	p. 40	p. 46
	60×60×115.8	1.25	500	1:3.6	0.55	PBDM603-C3.6	PBM603FGAE20	PB3D003M200-S3	p. 41	p. 46
	60×60×115.8	2.5	250	1:7.2	0.25	PBDM603-C7.2	PBM603FGBE20	PB3D003M200-S3	p. 41	p. 46
	60×60×115.8	3	180	1:10	0.25	PBDM603-C10	PBM603FGEE20	PB3D003M200-S3	p. 41	p. 46
	60×60×115.8	3.5	90	1:20	0.17	PBDM603-C20	PBM603FGGE20	PB3D003M200-S3	p. 41	p. 46
	60×60×115.8	4	60	1:30	0.17	PBDM603-C30	PBM603FGJE20	PB3D003M200-S3	p. 41	p. 46
Spur gear model	28×28×87.8	0.1	800	1:3.6	2	PBDM282-G3.6	PBM282FGAE20	PB3D003M200-S0	p. 42	p. 47
	28×28×87.8	0.15	400	1:7.2	2	PBDM282-G7.2	PBM282FGBE20	PB3D003M200-S0	p. 42	p. 47
	28×28×87.8	0.2	300	1:10	2	PBDM282-G10	PBM282FGEE20	PB3D003M200-S0	p. 42	p. 47
	28×28×87.8	0.35	150	1:20	1.5	PBDM282-G20	PBM282FGGE20	PB3D003M200-S0	p. 42	p. 47
	28×28×87.8	0.5	100	1:30	1.5	PBDM282-G30	PBM282FGJE20	PB3D003M200-S0	p. 42	p. 47
	28×28×87.8	0.5	60	1:50	1.5	PBDM282-G50	PBM282FGLE20	PB3D003M200-S0	p. 42	p. 47
	28×28×97	1.5 (2.7)	70	1:50	–	PBDM282-H50	PBM282FHLE20	PB3D003M200-S0	p. 43	p. 47
Harmonic gear model	28×28×97	2 (3.6)	35	1:100	–	PBDM282-H100	PBM282FHME20	PB3D003M200-S0	p. 43	p. 47
	42×42×97	2.2 (4.5)	116	1:30	–	PBDM423-H30	PBM423FHJE20	PB3D003M200-S2	p. 43	p. 47
	42×42×97	3.5 (8.3)	70	1:50	–	PBDM423-H50	PBM423FHLE20	PB3D003M200-S2	p. 43	p. 47
	42×42×97	5 (11)	35	1:100	–	PBDM423-H100	PBM423FHME20	PB3D003M200-S2	p. 43	p. 47
	60×60×137.3	5.5 (14)	70	1:50	–	PBDM603-H50	PBM603FHLE20	PB3D003M200-S3	p. 44	p. 47
	60×60×137.3	8 (20)	35	1:100	–	PBDM603-H100	PBM603FHME20	PB3D003M200-S3	p. 44	p. 47
	28×28×97.8	0.055	–	–	–	PBDM282-B	PBM282FCE20	PB3D003M200-S0	p. 45	p. 48
Electromagnetic brake model	28×28×117.1	0.115	–	–	–	PBDM284-B	PBM284FCE20	PB3D003M200-S1	p. 45	p. 48
	42×42×90	0.39	–	–	–	PBDM423-B	PBM423FCE20	PB3D003M200-S2	p. 45	p. 48
	60×60×113.6	1.3	–	–	–	PBDM603-B	PBM603FCE20	PB3D003M200-S3	p. 45	p. 48
	60×60×145.6	1.9	–	–	–	PBDM604-B	PBM604FCE20	PB3D003M200-S4	p. 45	p. 48

● The following items are included in the driver / cable set models.

Driver Model number: PB3D003M200-□

Power cable (1 m) Model number: PBC6P0010A

I/O signal cable (1 m, shielded) Model number: PBC5S0010C

* Numbers in parenthesis following allowable torques indicate allowable instantaneous torques.

Options and Peripherals

Product names	Standard model number (length)	Connector set model number	Extendable max. length	Remarks	Page
① Power cable	PBC6P0010A (1 m)	PBC6P0000A	3 m	–	p. 89
② Motor extension cable	PBC6M0030A (3 m)	PBC6M0000A	20 m	An extension cable is required when the distance between the motor and driver exceeds 50 cm.	p. 89
③ Encoder extension cable	PBC6E0030A (3 m)	PBC6E0000A	20 m	An extension cable is required when the distance between the motor and driver exceeds 50 cm.	p. 89
④ I/O signal cable (unshielded)	PBC5S0010A (1 m)	PBC5S0000A	2 m	Select the cable depending on peripheral noise.	p. 89
④ I/O signal cable (shielded)	PBC5S0010C (1 m)	PBC5S0000A	2 m	Used for pulse input	p. 90
⑤ Communication cable (between drivers)	PBC6C0003A (30 cm)	PBC6C0000A	100 m	Used when multiple axes are connected in a daisy chain configuration for communication. Not for use with pulse train input.	p. 90
⑥ Communications converter unit	PBFM-U6	–	–	A set of a converter (USB/RS-485) and a cable	p. 86
⑦ PC interface software	SPBA1W-01	–	–	Software for checking operation and parameter setting	p. 86

Driver Dimensions

Unit: mm

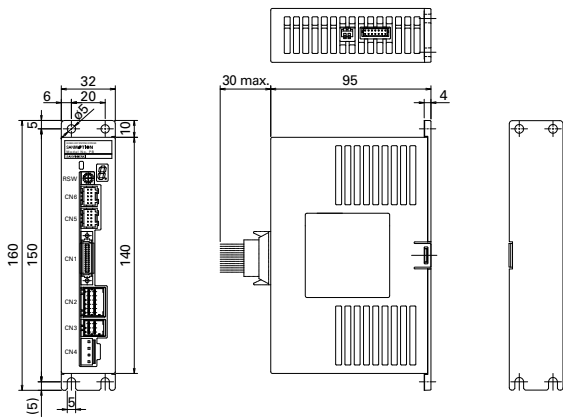

Driver types and main circuit power voltage variation

In addition to the set model driver PB3D003M200, the “dual power supply type” driver PB3D003M201—has two separated power supplies in main and control circuits—is also available for sale individually.

Note that 48 VDC main circuit supply are not available for some driver and motor combinations as in the table below.

	PB3D003M200 (Single power supply type) Sold either in a set model or individually	PB3D003M201 (Dual power supply type) Sold individually
28 mm sq. sized motor (of all models)	[Main circuit power supply] Only 24VDC power supply can be used	[Main circuit power supply] Only 24 VDC power supply can be used
Electromagnetic (EM) brake model motor	[Main circuit power supply] Only 24VDC power supply can be used	[Main circuit power supply] Either 24 or 48 VDC power supply can be used

Driver Specifications

General specifications

Model number		PB3D003M200 (Single power supply type), PB3D003M201 (Dual power supply type)		
Interface		RS-485+Parallel I/O (DIP switch SW1=ON)	Pulse train input (DIP switch SW1=OFF)	
Input power supply	Main circuit power supply	Single power supply type: 24/48 VDC ±10% (28 mm sq. motors and EM brake model motors can only be used with 24 VDC main circuit power supply. To power EM brake model motors by 48 VDC, please purchase dual power type driver.)		
	Control circuit power supply	Dual power supply type: (Main circuit power supply) 24/48 VDC ±10% (Only 24VDC available when used with 28 mm sq. motors) (Control circuit power supply) 24 VDC ±10%		
Control method		PWM control: Sinusoidal drive method		
Power supply current		Main circuit input current: 3 A Control circuit input current: 0.5 A (for EM brake model motors), 0.2 A (for the rest)		
Basic specifications	Protection class	Class III		
	Operation environment	Pollution degree: 2		
	Operating ambient temperature	0 to +55°C		
	Storage temperature	-20 to +70°C		
	Operating ambient humidity	90% RH max. (non-condensing)		
	Storage humidity	90% RH max. (non-condensing)		
	Operation altitude	1000 m or less above sea level		
	Vibration resistance	Tested under the following conditions: Acceleration: 5 m/s ² , Frequency range: 10 to 55 Hz, Axes of vibration: X, Y, Z (2 hours each)		
	Impact resistance	20 m/s ²		
Dielectric strength		No error observed when 1.1 kVAC is applied between power input terminal and frame for one minute.		
Insulation resistance		5 MΩ min. when measured with a 500 VDC megohmmeter between input terminal and frame.		
Mass		0.35 kg		
Rotational speed		0 to 4500 min ⁻¹		
Command resolution (P/R)		500, 1000, 2000, 4000, 5000, 10000		
Holding brake control function		Built in (however, can not be used for the single power supply type with 48VDC input)		
Protection functions		Power voltage error, regenerative voltage error, overspeed, encoder disconnection, CPU error, overload stop, excessive positional deviation, homing mode error, nonvolatile memory error, initialization error (power line disconnection)		
Display / Indication		7-segment LED display (1)		
Functions	Operating functions	Normal drive (relative motion, absolute motion), Homing mode operation, module operation, push operation, teaching function Point function: 128 Point Program function: 1 PRG×1024 Line 32 PRG×32 Line 128 PRG×8 Line	Normal drive, Homing mode operation	
	Rotary switch	Node address setting (0 to F)	Gain setting	
	DIP switch		SW1: Interface selection (ON=RS-485, OFF=Pulse) SW2: Terminating resistor setting (ON=with terminating resistor)	
	I/O signal	Function	(Normal Mode) ALMCLR General-purpose input×8 (select from Point, SELECT, EXE, ST, HOME, Limit, Pause, Inter Lock, Jog, and STOP) (Teaching Mode) STOP, JOG, Point, PWR	Pulse input, STOP, ALMCLR, Limit General-purpose input×5 (select from Gain selection, Deviation clear, HOME, Brake release, and Current limitation)
Electrical specifications		Input signal: 5 to 24 VDC	Pulse input: Photocoupler 3 to 5VDC (input resistance 270 Ω) Input signal: 5 to 24 VDC	
Function		(Normal Mode) ALM General-purpose output×9 (select from END, Ack, Busy, STEND, END, HEND, SON monitor, ZONE, MSTOP, Input monitor, Encoder output, In-Position, MODE monitor) (Teaching Mode) PEND, HEND, Jog MON, Mode MON, SON MON	ALM, In-Position, Homing mode operation complete, Encoder output, SON monitor, STOP monitor	
Electrical specifications		Output signal: Open collector 5 to 24VDC, 30 mA or less *The encoder Z-phase signal is only output at 200 min ⁻¹ or less.	Output signal: Open collector 5 to 24VDC, 30 mA or less *The encoder Z-phase signal is only output at 200 min ⁻¹ or less.	
Communication specifications		RS-485 Start / stop synchronization, half-duplex communication		
Baud rate		9600, 38400, 115200, 128000 bps		

Safety standards

	Directives	Standard	
CE (TÜV)	Low-voltage directives	EN 61010-1	
	EMC directives	EN 55011, EN 61000-6-2, EN 61000-6-4	
UL	Acquired standards	Applicable standard	File no.
	UL	UL 508C	
	cUL		E179775

External Wiring Diagram

RS-485+Parallel I/O DIP switch SW1=ON

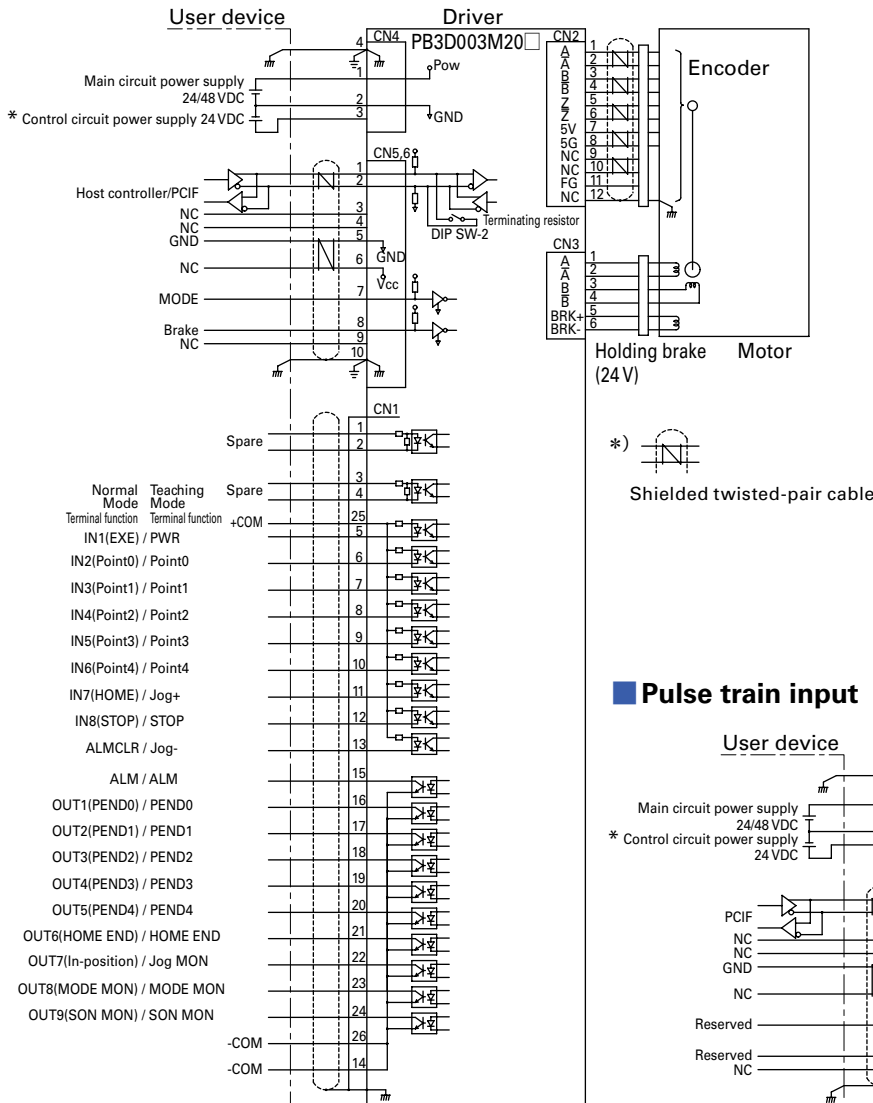

Pulse train input DIP switch SW1=OFF

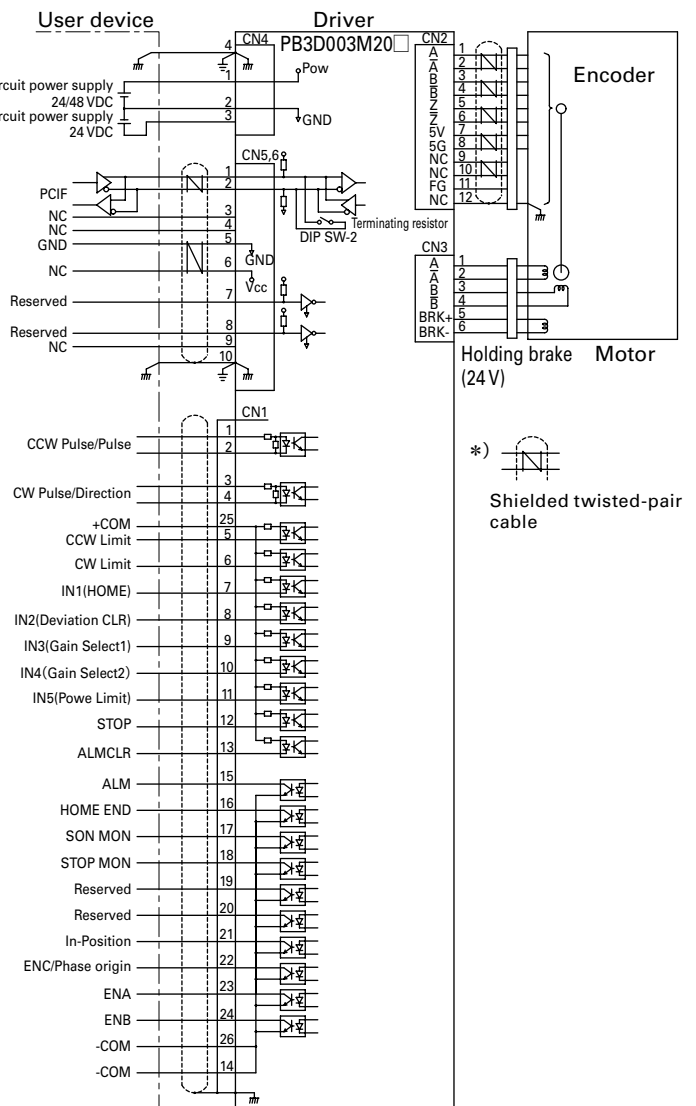

* Only with driver model PB3D003M201 (dual power type), connect to 24 VDC control circuit supply connector.

Wiring

Connector Models and Compatible Cables

Application	Connector no.	Description	Manufacturer model number	Compatible cables	Maximum extension length	Manufacturer
I/O signals	CN1	Plug (driver side) Receptacle	8830E-026-170LD 8822E-026-171D	AWG28 (7/0.127)	2 m	KEL CORPORATION
Encoder	CN2	Tab header (driver side)	1376020-1	AWG24, 26 Shielded twisted pair	20 m	Tyco Electronics Japan G.K.
		Receptacle housing	1-1318118-6			
		Receptacle contact	1318108-1 (single) 1318106-1 (linked)			
		Tab housing (for relay)	1-1318115-6			
		Tab contact (for relay)	1318112-1 (single) 1318110-1 (linked)			
Motor	CN3	Tab header (driver side)	1376136-1	AWG18 to 22 Discrete line	20 m	Tyco Electronics Japan G.K.
		Receptacle housing	1-1318119-3			
		Receptacle contact	1318107-1 (single) 1318105-1 (linked)			
		Tab housing (for relay)	1-1318115-3			
		Tab contact (for relay)	1318111-1 (single) 1318109-1 (linked)			
Power supply	CN4	Tab header (driver side)	B4PS-VH	AWG16 to 18 Discrete line	2 m	J.S.T.
		Receptacle housing	VHR-4N			
		Receptacle contact	SVH-21T-P1.1			
Communications	CN5	Post with base (driver side)	S10B-PADSS-1GW	AWG28 to 24 Shielded twisted pair	100 m	J.S.T.
	CN6	Housing	PADP-10V-1-S			
		Contact	SPH-002T-P0.5L			

- Refer to the manufacturer's catalog for detailed connector specifications.
- If the maximum extended length is exceeded, take necessary countermeasures to prevent malfunctions due to line noise.
- The relay connector is used to connect to the motor or encoder side connector when creating an extension cable.

Driver Components and Functions

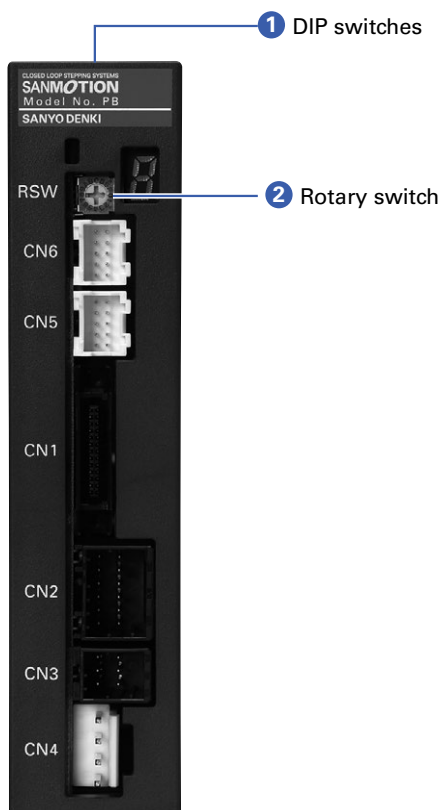

1 DIP switches
Switches for two functions: for selecting interface type, and for setting terminating resistor status.
Change switch settings while the power supply is off.
Settings cannot be changed while the power is on.

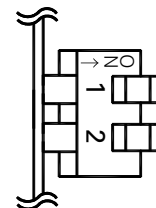

DSW No	Factory setting	Function	ON	OFF
1	ON	Interface type	RS-485+Parallel I/O	Pulse train input
2	ON	Terminating resistor setting	With terminating resistor	No terminating resistor

· When the DSW1 is ON (RS-485+Parallel I/O is selected) and you want to connect multiple nodes in daisy chain configuration, set ON only for the endpoint node and OFF for the rest. (When the pulse train input is selected, set all the nodes to ON.)

2 Rotary switch
Two types of parameters can be set, where the types depend on DSW1 setting (interface types).

DSW1 Setting	Rotary switch Function
ON (RS-485+Parallel I/O)	Node address setting (setting range: 0 to F) * Sets the node address for when multiple axes are connected.
OFF (pulse train input)	Speed loop gain setting (setting range: 0 to F)

· The factory setting is 0.

Size	Motor size	28 mm sq.		42 mm sq.	60 mm sq.	
	Motor length	58.5 mm	77.8 mm	57.6 mm	70.3 mm	102.3 mm
Motor model number		PBM282FXE20	PBM284FXE20	PBM423FXE20	PBM603FXE20	PBM604FXE20
Set model number		PBDM282	PBDM284	PBDM423	PBDM603	PBDM604
Compatible driver model number		PB3D003M200	PB3D003M200	PB3D003M200	PB3D003M200	PB3D003M200
Max. stall torque	N·m	0.055	0.155	0.39	1.3	1.9
Rotor inertia	×10 ⁻⁴ kg·m ²	0.008	0.016	0.056	0.4	0.84
Allowable thrust load	N	9.8	9.8	9.8	14.7	14.7
Allowable radial load *	N	33	33	49	167	167
Motor mass	kg	0.16	0.23	0.35	0.85	1.42
Characteristics diagram		①	②	③	④	⑤

● Maintain motor surface temperature at 85°C or lower while in use.
 * When load is applied at 1/3 length from output shaft end.

Characteristics diagram

Torque 24VDC — 48VDC — Power supply current 24VDC - - - 48VDC - - -

① Motor model number **PBM282FXE20**

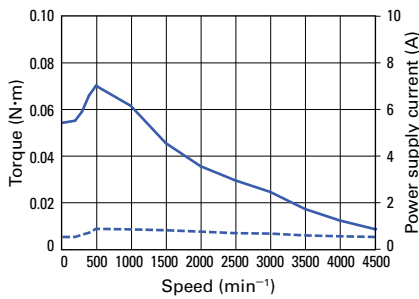

② Motor model number **PBM284FXE20**

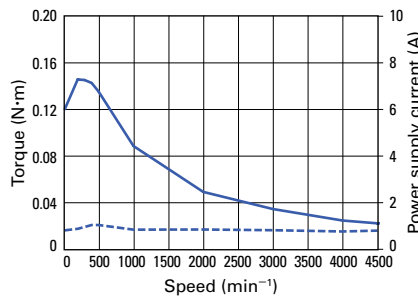

③ Motor model number **PBM423FXE20**

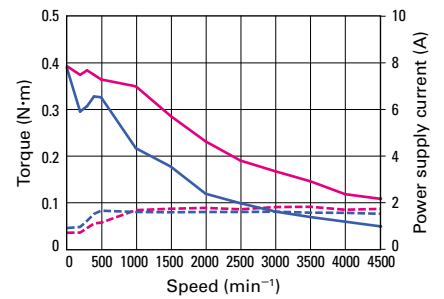

④ Motor model number **PBM603FXE20**

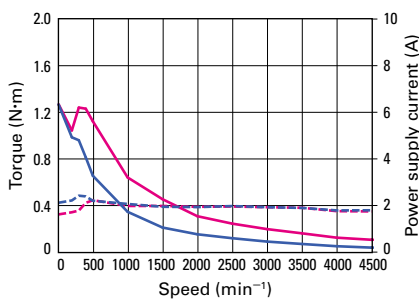

⑤ Motor model number **PBM604FXE20**

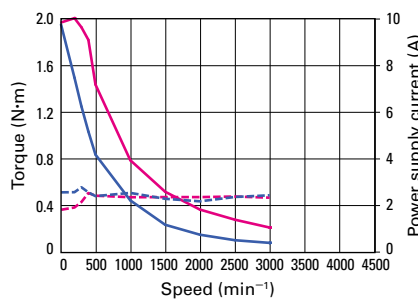

Low-backlash gear model

RoHS

Size	Motor size	42 mm sq.				
	Motor + gear length	87.9 mm				
Motor model number		PBM423FGAE20	PBM423FGBE20	PBM423FGEE20	PBM423FGGE20	PBM423FGJE20
Set model number		PBDM423-C3.6	PBDM423-C7.2	PBDM423-C10	PBDM423-C20	PBDM423-C30
Compatible driver model number		PB3D003M200	PB3D003M200	PB3D003M200	PB3D003M200	PB3D003M200
Allowable torque	N·m	0.343	0.686	0.98	1.47	1.47
Rotor inertia	$\times 10^{-4}$ kg·m ²	0.056	0.056	0.056	0.056	0.056
Gear ratio	—	1:3.6	1:7.2	1:10	1:20	1:30
Backlash	deg. or less	0.6	0.4	0.35	0.25	0.25
Allowable speed	min ⁻¹	500	250	180	90	60
Rotation direction	Relative to command direction	Forward	Forward	Forward	Reverse	Reverse
Allowable thrust load	N	15	15	15	15	15
Allowable radial load *	N	20	20	20	20	20
Motor mass	kg	0.48	0.48	0.48	0.48	0.48
Characteristics diagram		①	②	③	④	⑤

● Maintain motor surface temperature at 85°C or lower while in use.
* When load is applied at 1/3 length from output shaft end.

Characteristics diagram

Allowable torque 24 VDC — 48 VDC — 24 VDC/48 VDC — Power supply current 24 VDC - - - 48 VDC - - -

① Motor model number **PBM423FGAE20**

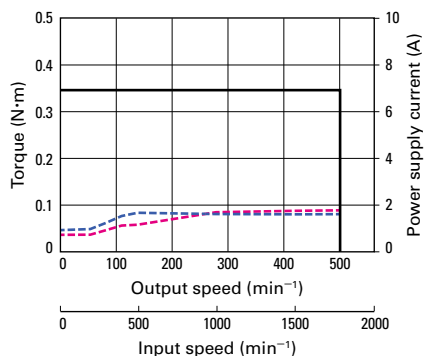

② Motor model number **PBM423FGBE20**

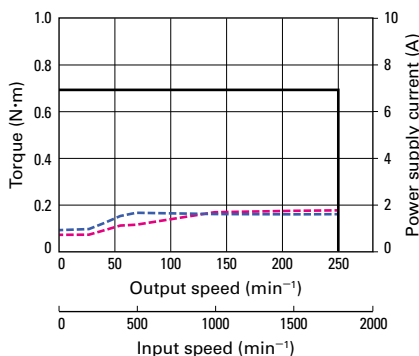

③ Motor model number **PBM423FGEE20**

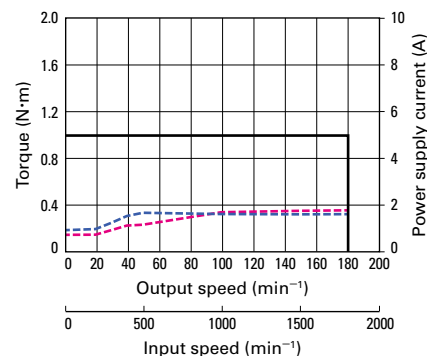

④ Motor model number **PBM423FGGE20**

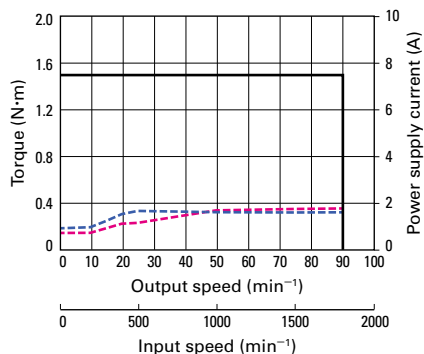

⑤ Motor model number **PBM423FGJE20**

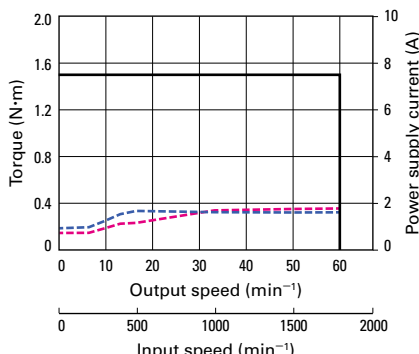

System Configuration Diagram ▶ p. 34 Set Model Configurations ▶ p. 35 Driver Dimensions ▶ p. 36 Motor Dimensions ▶ pp. 46 to 48

When using a motor with low-backlash gear, exceeding the allowable torque might damage the gear. Carefully select products so that the configured system can operate within the specified limit value.

● Data for the above characteristics is based on SANYO DENKI's internal measurement conditions. Depending on conditions such as machine precision, driving torque may vary as well.

Size	Motor size	60 mm sq.				
	Motor + gear length	115.8 mm				
Motor model number		PBM603FGAE20	PBM603FGBE20	PBM603FGEE20	PBM603FGGE20	PBM603FGJE20
Set model number		PBDM603-C3.6	PBDM603-C7.2	PBDM603-C10	PBDM603-C20	PBDM603-C30
Compatible driver model number		PB3D003M200	PB3D003M200	PB3D003M200	PB3D003M200	PB3D003M200
Allowable torque	N·m	1.25	2.5	3	3.5	4
Rotor inertia	$\times 10^{-4}$ kg·m ²	0.4	0.4	0.4	0.4	0.4
Gear ratio	—	1:3.6	1:7.2	1:10	1:20	1:30
Backlash	deg. or less	0.55	0.25	0.25	0.17	0.17
Allowable speed	min ⁻¹	500	250	180	90	60
Rotation direction	Relative to command direction	Forward	Forward	Reverse	Reverse	Reverse
Allowable thrust load	N	30	30	30	30	30
Allowable radial load *	N	100	100	100	100	100
Motor mass	kg	1.22	1.22	1.22	1.22	1.22
Characteristics diagram		①	②	③	④	⑤

● Maintain motor surface temperature at 85°C or lower while in use.
 * When load is applied at 1/3 length from output shaft end.

Characteristics diagram

Allowable torque 24 VDC — 48 VDC — 24 VDC/48 VDC — Power supply current 24 VDC - - - 48 VDC - - -

① Motor model number **PBM603FGAE20**

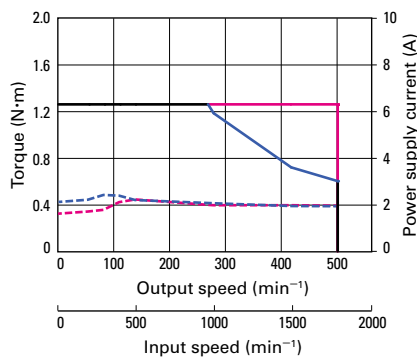

② Motor model number **PBM603FGBE20**

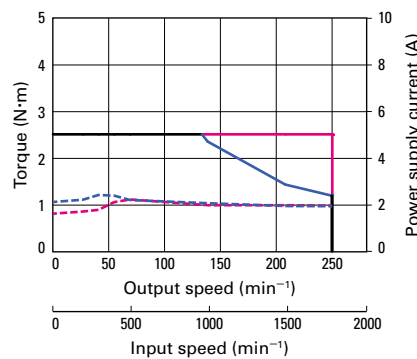

③ Motor model number **PBM603FGEE20**

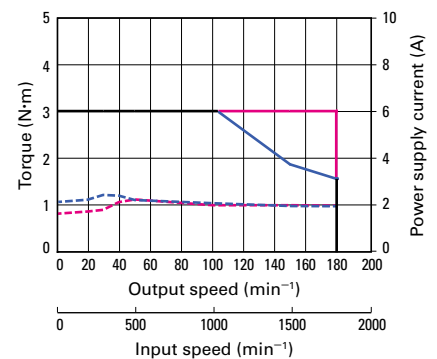

④ Motor model number **PBM603FGGE20**

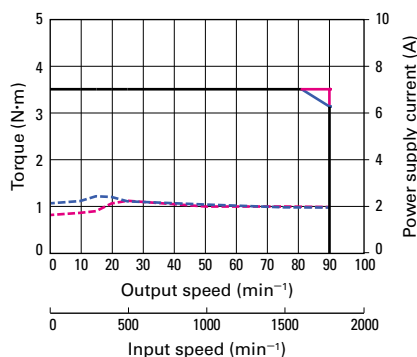

⑤ Motor model number **PBM603FGJE20**

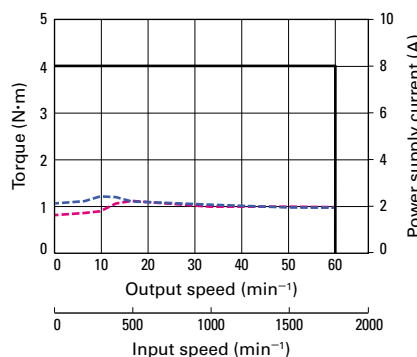

Spur gear model

RoHS

Size	Motor size	28 mm sq.					
	Motor + gear length	87.8 mm					
Motor model number		PBM282FGAE20	PBM282FGBE20	PBM282FGEE20	PBM282FGGE20	PBM282FGJE20	PBM282FGLE20
Set model number		PBDM282-G3.6	PBDM282-G7.2	PBDM282-G10	PBDM282-G20	PBDM282-G30	PBDM282-G50
Compatible driver model number		PB3D003M200	PB3D003M200	PB3D003M200	PB3D003M200	PB3D003M200	PB3D003M200
Allowable torque	N·m	0.1	0.15	0.2	0.35	0.5	0.5
Rotor inertia	$\times 10^{-4}$ kg·m ²	0.009	0.009	0.009	0.009	0.009	0.009
Gear ratio	—	1:3.6	1:7.2	1:10	1:20	1:30	1:50
Backlash	deg. or less	2	2	2	1.5	1.5	1.5
Allowable speed	min ⁻¹	800	400	300	150	100	60
Rotation direction	Relative to command direction	Forward	Forward	Reverse	Forward	Forward	Forward
Allowable thrust load	N	10	10	10	10	10	10
Allowable radial load *	N	15	15	15	15	15	15
Motor mass	kg	0.22	0.22	0.22	0.22	0.22	0.22
Characteristics diagram		①	②	③	④	⑤	⑥

● Maintain motor surface temperature at 85°C or lower while in use.
* When load is applied at 1/3 length from output shaft end.

Characteristics diagram

Allowable torque 24 VDC — 48 VDC — 24 VDC/48 VDC — Power supply current 24 VDC - - - 48 VDC - - -

① Motor model number **PBM282FGAE20**

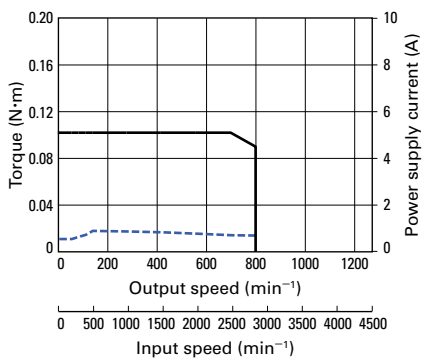

② Motor model number **PBM282FGBE20**

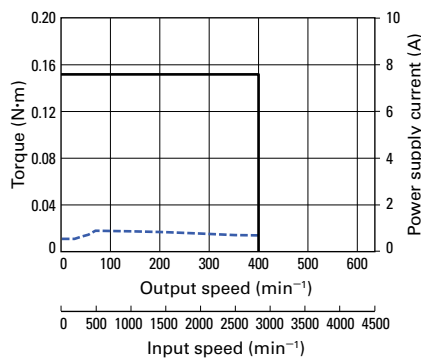

③ Motor model number **PBM282FGEE20**

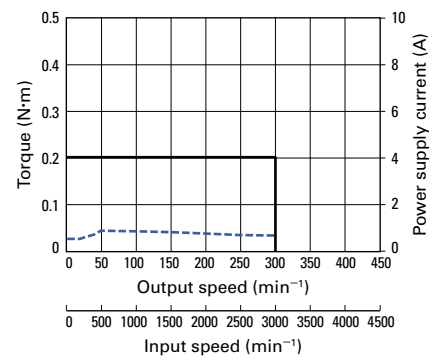

④ Motor model number **PBM282FGGE20**

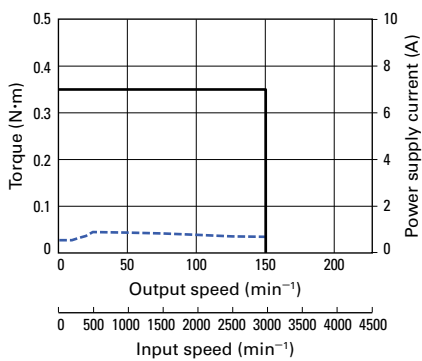

⑤ Motor model number **PBM282FGJE20**

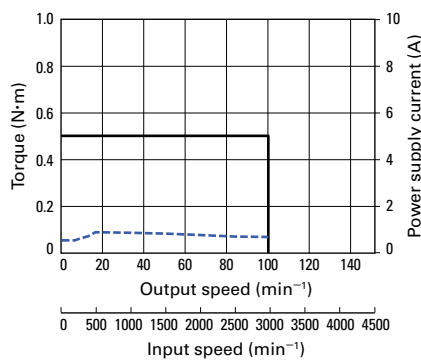

⑥ Motor model number **PBM282FGLE20**

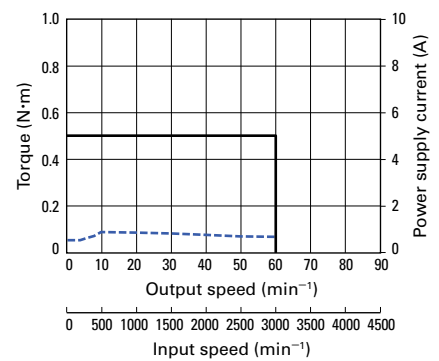

System Configuration Diagram ▶ p. 34 Set Model Configurations ▶ p. 35 Driver Dimensions ▶ p. 36 Motor Dimensions ▶ pp. 46 to 48

When using a motor with spur gear, exceeding the allowable torque might damage the gear. Carefully select products so that the configured system can operate within the specified limit value.
● Data for the above characteristics is based on SANYO DENKI's internal measurement conditions. Depending on conditions such as machine precision, driving torque may vary as well.

Size	Motor size	28 mm sq. (angular dimension 33 mm sq.)		42 mm sq.		
	Motor + gear length	97 mm		97 mm		
Motor model number		PBM282FHLE20	PBM282FHME20	PBM423FHJE20	PBM423FHLE20	PBM423FHME20
Set model number		PBDM282-H50	PBDM282-H100	PBDM423-H30	PBDM423-H50	PBDM423-H100
Compatible driver model number		PB3D003M200	PB3D003M200	PB3D003M200	PB3D003M200	PB3D003M200
Allowable torque	N·m	1.5	2	2.2	3.5	5
Allowable instantaneous torque	N·m	2.7	3.6	4.5	8.3	11
Rotor inertia	$\times 10^{-4}$ kg·m ²	0.012	0.012	0.068	0.068	0.068
Gear ratio	—	1:50	1:100	1:30	1:50	1:100
Hysteresis loss	Arc min or less	—	—	3.6	2.4	2.4
Lost motion	Arc min	0.4 to 3 (at ± 0.06 N·m)	0.4 to 3 (at ± 0.08 N·m)	—	—	—
Allowable speed	min ⁻¹	70	35	116	70	35
Rotation direction	Relative to command direction	Reverse	Reverse	Reverse	Reverse	Reverse
Allowable thrust load	N	100	100	1150	1150	1150
Allowable radial load *	N	160	160	275	275	275
Motor mass	kg	0.27	0.27	0.54	0.54	0.54
Characteristics diagram		①	②	③	④	⑤

● Maintain motor surface temperature at 85°C or lower while in use.

* When load is applied at 1/3 length from output shaft end.

Characteristics diagram

Allowable torque 24 VDC — 48 VDC — 24 VDC/48 VDC —
 Allowable instantaneous torque 24 VDC - - - 48 VDC - - - 24 VDC/48 VDC - - - Power supply current 24 VDC 48 VDC

① Motor model number **PBM282FHLE20**

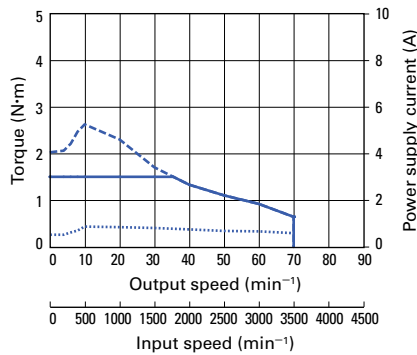

② Motor model number **PBM282FHME20**

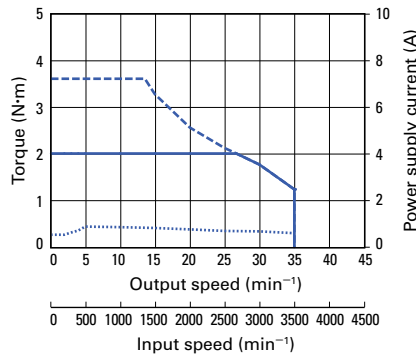

③ Motor model number **PBM423FHJE20**

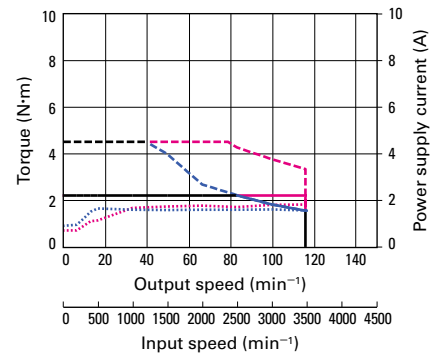

④ Motor model number **PBM423FHLE20**

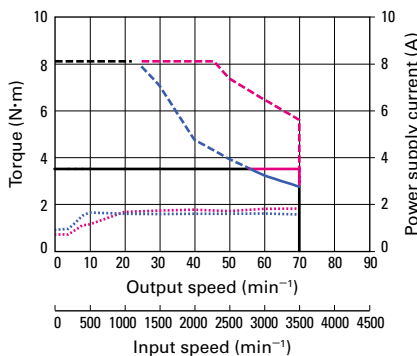

⑤ Motor model number **PBM423FHME20**

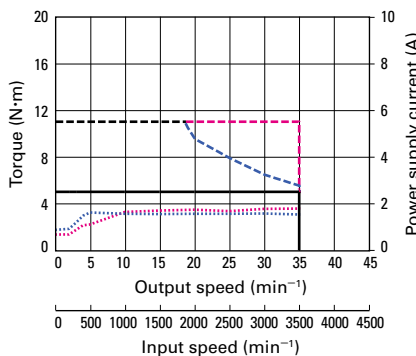

System Configuration Diagram ▶ p. 34 Set Model Configurations ▶ p. 35 Driver Dimensions ▶ p. 36 Motor Dimensions ▶ pp. 46 to 48

When using a motor with harmonic gear, exceeding the allowable instantaneous torque might damage the gear. Carefully select products so that the configured system can operate within the specified limit value.

● Data for the above characteristics is based on SANYO DENKI's internal measurement conditions. Depending on conditions such as machine precision, driving torque may vary as well.

Harmonic gear model

Size		60 mm sq. 137.3 mm	
Motor size	Motor + gear length		
Motor model number		PBM603FHLE20	PBM603FHME20
Set model number		PBDM603-H50	PBDM603-H100
Compatible driver model number		PB3D003M200	PB3D003M200
Allowable torque	N·m	5.5	8
Allowable instantaneous torque	N·m	14	20
Rotor inertia	$\times 10^{-4}$ kg·m ²	0.435	0.435
Gear ratio	—	1:50	1:100
Hysteresis loss	Arc min or less	—	—
Lost motion	Arc min	0.4 to 3 (at ± 0.28 N·m)	0.4 to 1.5 (at ± 0.4 N·m)
Allowable speed	min ⁻¹	70	35
Rotation direction	Relative to command direction	Reverse	Reverse
Allowable thrust load	N	400	400
Allowable radial load *	N	360	360
Motor mass	kg	1.45	1.45
Characteristics diagram		①	②

● Maintain motor surface temperature at 85°C or lower while in use.

* When load is applied at 1/3 length from output shaft end.

Characteristics diagram

Allowable torque 24 VDC — 48 VDC — 24 VDC/48 VDC —
 Allowable instantaneous torque 24 VDC - - - 48 VDC - - - 24 VDC/48 VDC - - - Power supply current 24 VDC 48 VDC

① Motor model number **PBM603FHLE20**

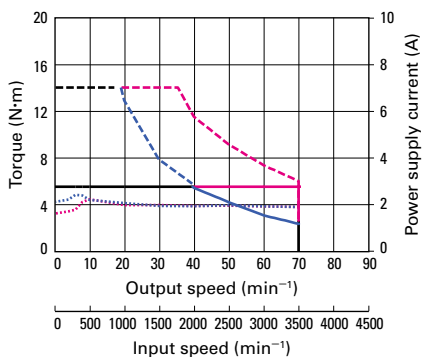

② Motor model number **PBM603FHME20**

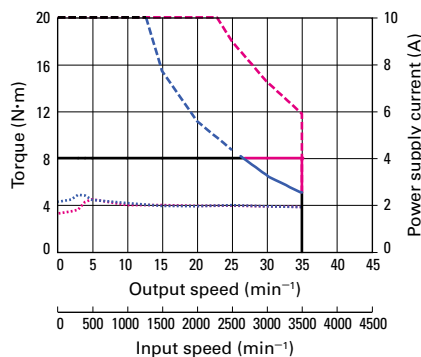

System Configuration Diagram ▶ p. 34 Set Model Configurations ▶ p. 35 Driver Dimensions ▶ p. 36 Motor Dimensions ▶ pp. 46 to 48

When using a motor with harmonic gear, exceeding the allowable instantaneous torque might damage the gear. Carefully select products so that the configured system can operate within the specified limit value.

● Data for the above characteristics is based on SANYO DENKI's internal measurement conditions. Depending on conditions such as machine precision, driving torque may vary as well.

Size	Motor size		28 mm sq.		42 mm sq.	60 mm sq.		
	Motor + brake length		97.8 mm	117.1 mm	90 mm	113.6 mm	145.6 mm	
Motor model number			PBM282FCE20	PBM284FCE20	PBM423FCE20	PBM603FCE20	PBM604FCE20	
Set model number			PBDM282-B	PBDM284-B	PBDM423-B	PBDM603-B	PBDM604-B	
Compatible driver model number			PB3D003M200	PB3D003M200	PB3D003M200	PB3D003M200	PB3D003M200	
Max. stall torque		N·m	0.055	0.115	0.39	1.3	1.9	
Rotor inertia		$\times 10^{-4} \text{kg}\cdot\text{m}^2$	0.0091	0.0171	0.071	0.559	1.0	
Allowable thrust load		N	9.8	9.8	9.8	14.7	14.7	
Allowable radial load *		N	33	33	49	167	167	
Motor mass		kg	0.28	0.35	0.5	1.19	1.76	
Electromagnetic brake	Brake type		No excitation actuating type		No excitation actuating type		No excitation actuating type	
	Power supply voltage		24 VDC \pm 5%		24 VDC \pm 5%		24 VDC \pm 5%	
	Excitation current		0.15		0.1		0.25	
	Power consumption		3.6		2.4		6	
	Static friction torque		N·m or over		0.049		0.78	
	Brake operating time		ms or less		20		20	
	Brake release time		ms or less		20		30	
Characteristics diagram			①	②	③	④	⑤	

Set model motors (of EM brake model) can't be powered by 48 VDC main circuit power supply. If you would like, please purchase "dual power supply type" driver PB3D003M201, instead.

● Maintain motor surface temperature at 85°C or lower while in use.

* When load is applied at 1/3 length from output shaft end.

Characteristics diagram

Torque 24VDC — Power supply current 24VDC - - - - -

① Motor model number **PBM282FCE20**

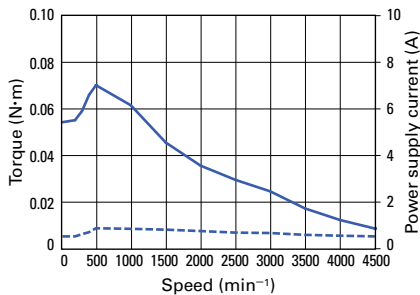

② Motor model number **PBM284FCE20**

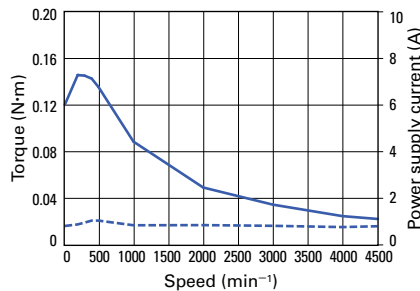

③ Motor model number **PBM423FCE20**

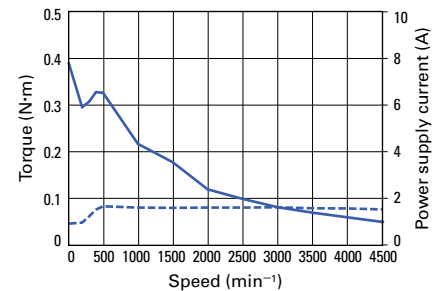

④ Motor model number **PBM603FCE20**

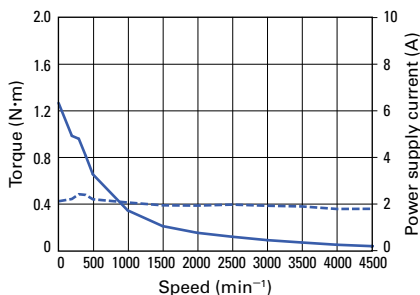

⑤ Motor model number **PBM604FCE20**

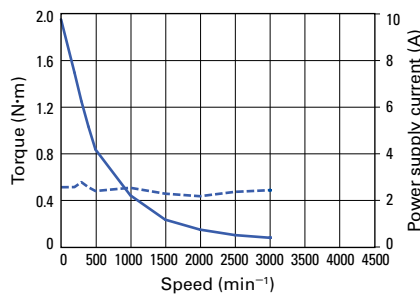

Motor Dimensions Unit: mm

Standard model

28 mm sq.

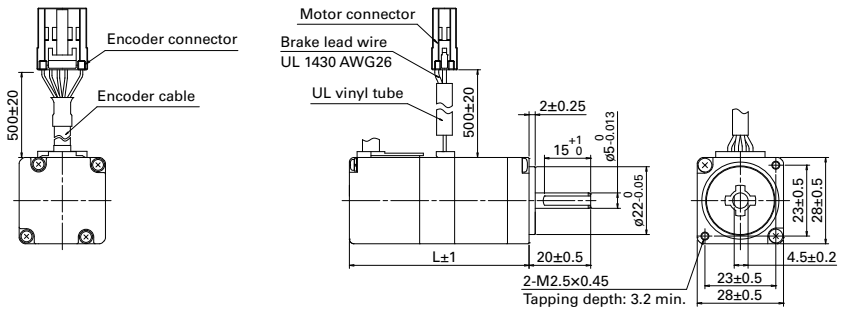

Motor model number	Motor length (L)
PBM282FXE20	58.5
PBM284FXE20	77.8

42 mm sq.

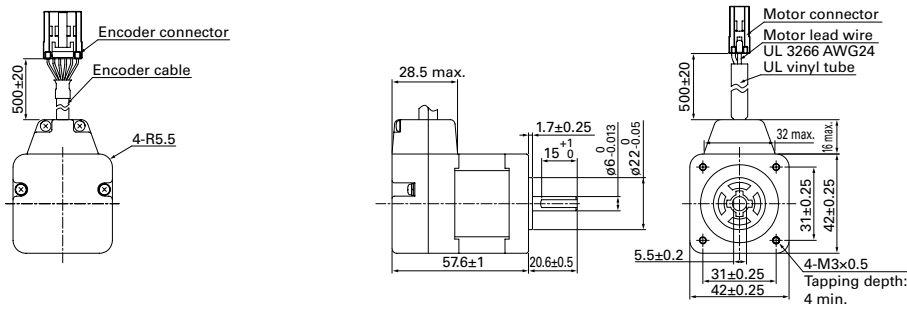

60 mm sq.

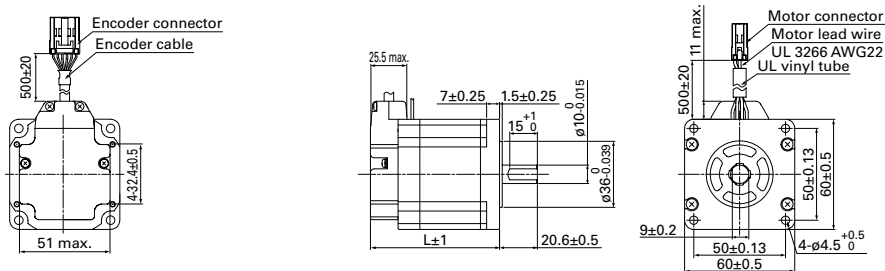

Motor model number	Motor length (L)
PBM603FXE20	70.3
PBM604FXE20	102.3

Low-backlash gear model

42 mm sq.

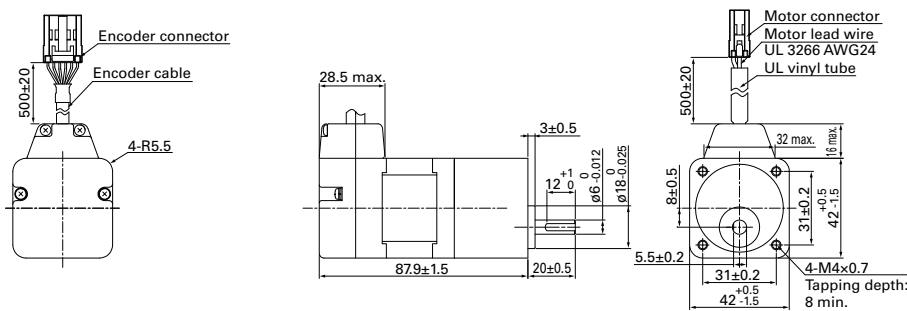

60 mm sq.

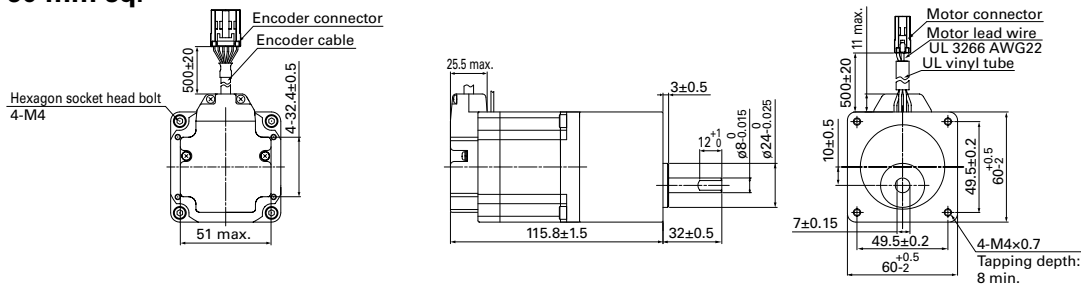

Spur gear model

28 mm sq.

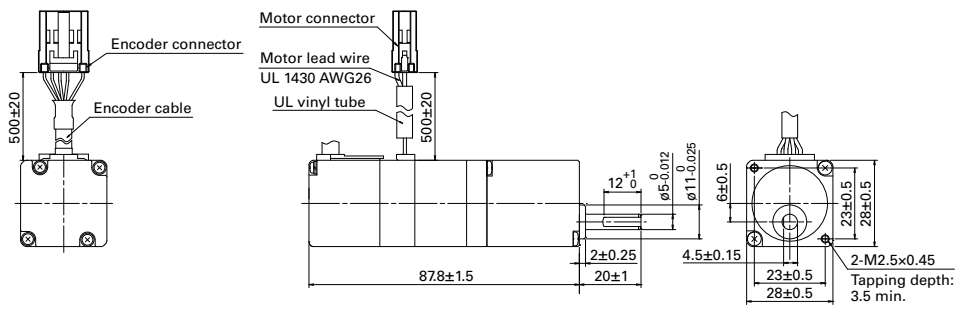

Harmonic gear model

28 mm sq.

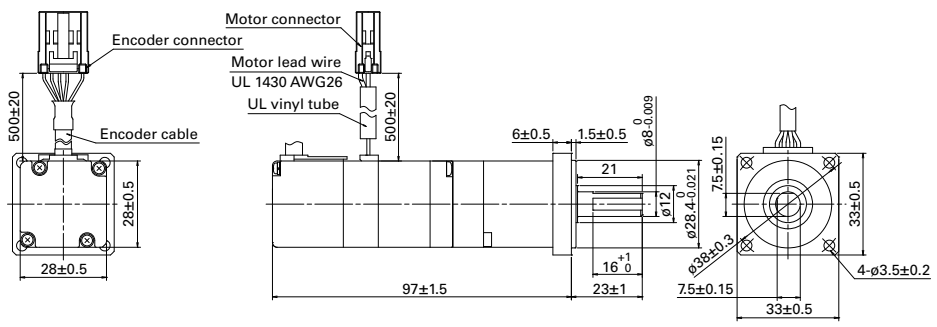

42 mm sq.

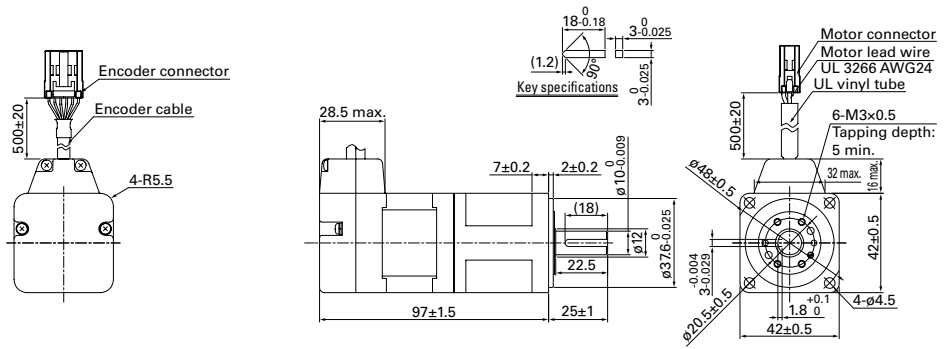

60 mm sq.

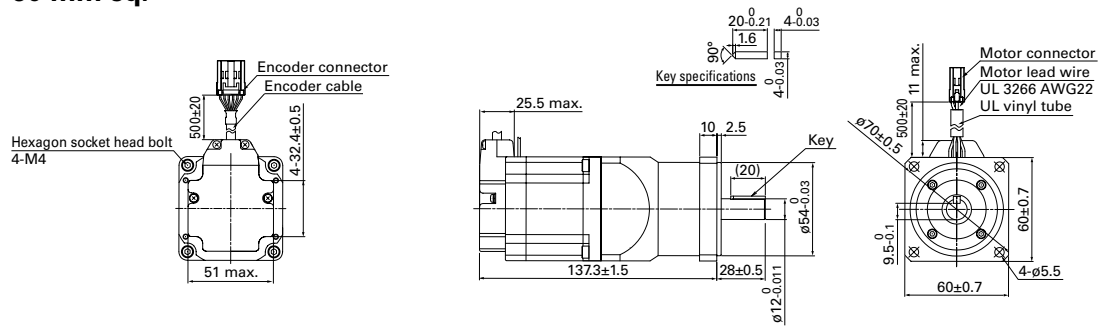

Motor Dimensions Unit: mm

Electromagnetic brake model

28 mm sq.

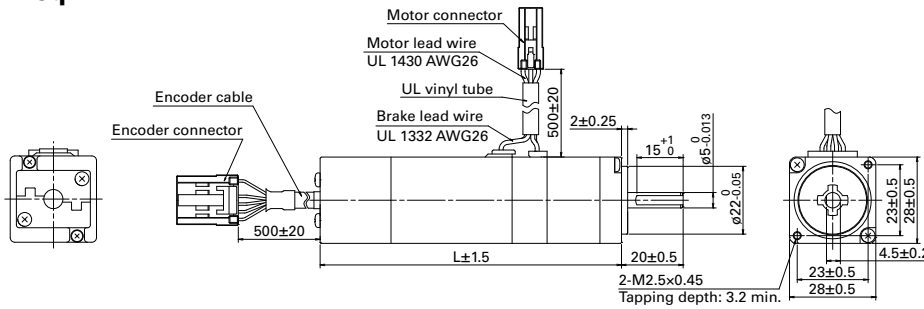

Motor model number	Motor length (L)
PBM282FCE20	97.8
PBM284FCE20	117.1

42 mm sq.

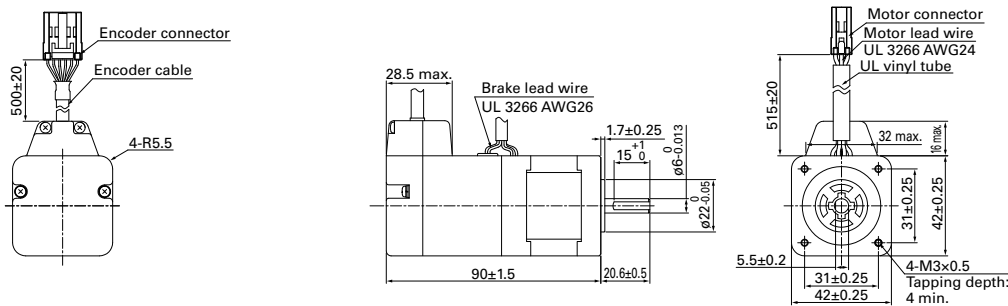

60 mm sq.

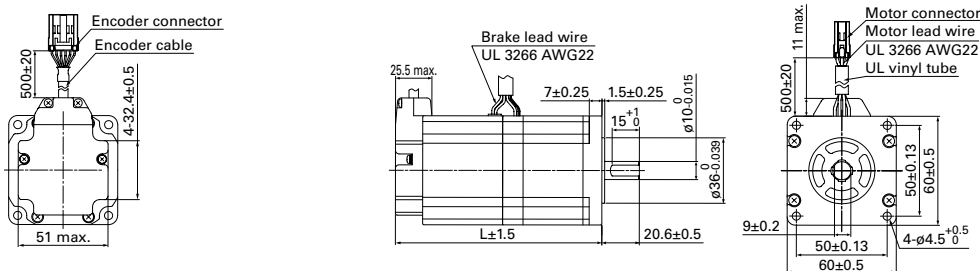

Motor model number	Motor length (L)
PBM603FCE20	113.6
PBM604FCE20	145.6

Connector specifications

Encoder connector

Housing: 1-1318118-6
Terminal: 1318106-1
Manufacturer: Tyco Electronics Japan G.K.

Motor connector

Housing: 1-1318119-3
Terminal: 1318105-1
Manufacturer: Tyco Electronics Japan G.K.

Connections of encoder side connectors

Pin no.	Lead wire color	Signal name
A1	Blue	CHANNEL A
B1	Brown	CHANNEL \bar{A}
A2	Green	CHANNEL B
B2	Purple	CHANNEL \bar{B}
A3	White	CHANNEL Z
B3	Yellow	CHANNEL \bar{Z}
A4	Red	+5V
B4	Black	0V
A5	N.C.	—
B5	Orange	OVER HEAT
A6	Black	Shielded
B6	N.C.	—

Encoder cable: UL20276

Connections of motor side connectors

Standard model, Low-backlash gear model, Spur gear model, Harmonic gear model

Pin no.	Lead wire color	Signal name
A1	Blue	Motor lead wire
B1	Orange	Motor lead wire
A2	Red	Motor lead wire
B2	Yellow	Motor lead wire
A3	N.C.	—
B3	N.C.	—

Electromagnetic brake model

Pin no.	Lead wire color	Signal name
A1	Blue	Motor lead wire
B1	Orange	Motor lead wire
A2	Red	Motor lead wire
B2	Yellow	Motor lead wire
A3	28 mm sq.: Brown 42 mm sq.: Brown 60 mm sq.: White	Brake lead wire
B3	28 mm sq.: Brown 42 mm sq.: White 60 mm sq.: Black	Brake lead wire

Motor Specifications

General specifications

Motor model number	PBM28□F□E	PBM423F□E	PBM60□F□E
Type	S1 (continuous operation)		
Operating ambient temperature	-10 to +40°C (0 to +40°C for harmonic gear model)		
Storage ambient temperature	-20 to +60°C		
Operating ambient humidity	20 to 90% RH		
Storage ambient humidity	5 to 95% RH		
Operation altitude	1000 m or less above sea level		
Vibration resistance	Tested with frequency 10 to 500 Hz, total amplitude 1.52 mm (10 to 70 Hz), acceleration 150 m/s ² (70 to 500 Hz), sweep time 15 min/cycle, 12 sweeps in each X, Y and Z direction.		
Impact resistance	Tested with 500 m/s ² of acceleration for 11 ms with half-sine wave applying three times for X, Y and Z axes each, 18 times in total.		
Thermal class	B (+130°C)		
Dielectric strength	At normal temperature and humidity, no failure with 500 VAC at 50/60 Hz applied for one minute between motor winding and frame.	At normal temperature and humidity, no failure with 1500 VAC at 50/60 Hz applied for one minute between motor winding and frame.	
Insulation resistance	At normal temperature and humidity, not less than 100 MΩ when measured with a 500 VDC megohmmeter between motor winding and frame.		
Protection grade	IP40		
Thrust play *	0.075 mm max. (load: 1.5 N)	0.075 mm max. (load: 5 N)	0.075 mm max. (load: 10 N)
Radial play **	0.025 mm max. (load: 5 N)		
Shaft runout	0.025 mm		
Concentricity of mounting pilot relative to shaft	ø0.075 mm		
Perpendicularity of mounting surface relative to shaft	0.1 mm		
Motor mounting orientation	Can be freely mounted vertically or horizontally		
Encoder	Resolution	500×4=2000 P/R	
	Number of channels	3 CH ***	
	Output method	Line driver	
	Max. response frequency	37.5 kHz	
	Power supply voltage	5 VDC ±5%	
	Current consumption	140 mA max.	

● The user should not test the insulation resistance or insulation withstand voltage because capacitors are inserted into the encoder output ground line and the frame line to prevent noise.

● Take radiation and drive conditions into consideration to maintain motor surface temperature at 85°C or lower while in use.

* Thrust play: Displacement in shaft position in the axial direction when a load is applied to the motor shaft in the axial direction.

** Radial play: Displacement in shaft position in the radial direction when a load is applied in the vertical direction to the mounting surface of shaft at point 1/3 the shaft length from the end of the motor shaft.

*** The Z channel outputs 51 pulses. It is designed for use with drivers listed in this catalog.

DC Input Drivers / Motors

Type P Multi-axis Pulse Train Input type



Lineup **RoHS**

Motor

Motor size: 28 mm sq., 42 mm sq., 60 mm sq.

Driver **CE** **RoHS** **cULus**

Model number: PB4D003P340 Input power supply: 24/48 VDC
Number of control axes: 4

Compatible Driver / Motor Combinations ▶ p. 51 Driver Dimensions ▶ p. 52
Driver Specifications ▶ p. 52 Specifications / Characteristics Diagram ▶ pp. 55 to 61
Motor Dimensions ▶ pp. 79 to 83 Motor Specifications ▶ p. 84

System Configuration Diagram

24/48 VDC

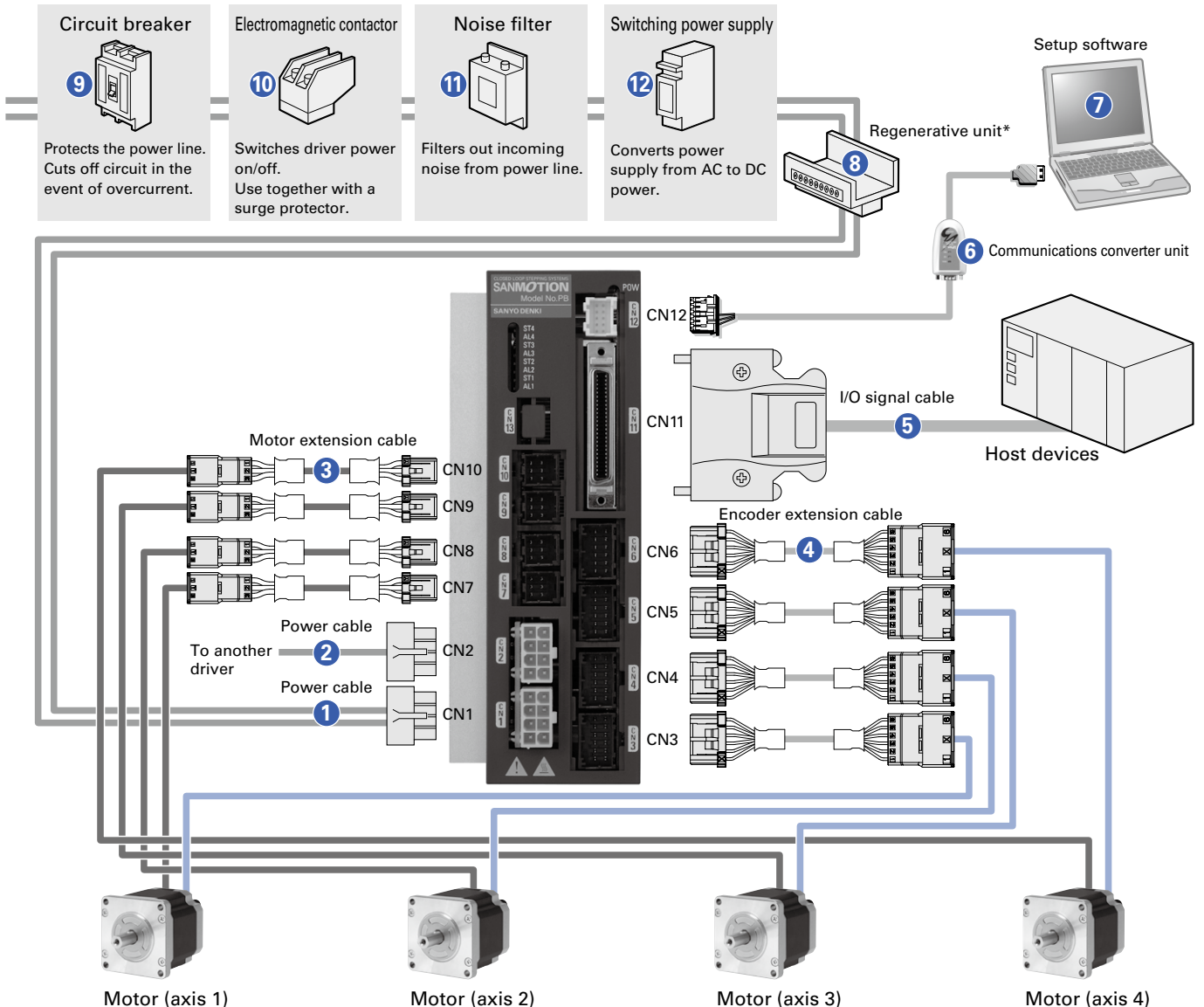

* Connect the regenerative unit when a 60 mm sq. motor is used. Check the voltage while in operation. To be provided by the customer. **9** to **12**

Compatible Driver / Motor Combinations

No set models are available with this driver. Since this driver is capable of controlling multiple axes, order the necessary number of motors.

Model	Motor external dimensions Flange size × Motor length (mm)	Max. stall torque (allowable torque* for models with gear) (N·m)	Allowable speed (min ⁻¹)	Gear ratio	Backlash (deg.)	Motor model number	Driver model number	Page		
								Specifications	Motor dimensions	
Standard model	28×28×59.2	0.055	–	–	–	PBM281DXE50	PB4D003P340	p. 55	p. 79	
	28×28×78.5	0.115	–	–	–	PBM285DXE50	PB4D003P340	p. 55	p. 79	
	42×42×55.9	0.39	–	–	–	PBM423DXK50	PB4D003P340	p. 55	p. 79	
	60×60×68.8	1.05	–	–	–	PBM603DXK50	PB4D003P340	p. 55	p. 79	
	60×60×100.8	1.85	–	–	–	PBM604DXK50	PB4D003P340	p. 55	p. 79	
Low-backlash gear model	42×42×86.1	0.343	500	1:3.6	0.6	PBM423DGAK50	PB4D003P340	p. 56	p. 79	
	42×42×86.1	0.686	250	1:7.2	0.4	PBM423DGBK50	PB4D003P340	p. 56	p. 79	
	42×42×86.1	0.98	180	1:10	0.35	PBM423DGEK50	PB4D003P340	p. 56	p. 79	
	42×42×86.1	1.47	90	1:20	0.25	PBM423DGGK50	PB4D003P340	p. 56	p. 79	
	42×42×86.1	1.47	60	1:30	0.25	PBM423DGJK50	PB4D003P340	p. 56	p. 79	
	60×60×114.3	1.25	500	1:3.6	0.55	PBM603DGAK50	PB4D003P340	p. 57	p. 79	
	60×60×114.3	2.5	250	1:7.2	0.25	PBM603DGBK50	PB4D003P340	p. 57	p. 79	
	60×60×114.3	3	180	1:10	0.25	PBM603DGEK50	PB4D003P340	p. 57	p. 79	
	60×60×114.3	3.5	90	1:20	0.17	PBM603DGGK50	PB4D003P340	p. 57	p. 79	
	60×60×114.3	4	60	1:30	0.17	PBM603DGJK50	PB4D003P340	p. 57	p. 79	
	Spur gear model	28×28×88.6	0.1	800	1:3.6	2	PBM281DGAE50	PB4D003P340	p. 58	p. 80
		28×28×88.6	0.15	400	1:7.2	2	PBM281DGBE50	PB4D003P340	p. 58	p. 80
28×28×88.6		0.2	300	1:10	2	PBM281DGEE50	PB4D003P340	p. 58	p. 80	
28×28×88.6		0.35	150	1:20	1.5	PBM281DGE50	PB4D003P340	p. 58	p. 80	
28×28×88.6		0.5	100	1:30	1.5	PBM281DGJE50	PB4D003P340	p. 58	p. 80	
28×28×88.6		0.5	60	1:50	1.5	PBM281DGLE50	PB4D003P340	p. 58	p. 80	
Harmonic gear model	28×28×97.7	1.5 (2.6)	70	1:50	–	PBM281DHLE50	PB4D003P340	p. 59	p. 80	
	28×28×97.7	2 (3.6)	35	1:100	–	PBM281DHME50	PB4D003P340	p. 59	p. 80	
	42×42×95.1	2.2 (4.5)	116	1:30	–	PBM423DHJK50	PB4D003P340	p. 59	p. 80	
	42×42×95.1	3.5 (8.3)	70	1:50	–	PBM423DHLK50	PB4D003P340	p. 59	p. 80	
	42×42×95.1	5 (11)	35	1:100	–	PBM423DHMK50	PB4D003P340	p. 59	p. 80	
	60×60×135.8	5.5 (14)	70	1:50	–	PBM603DHLK50	PB4D003P340	p. 60	p. 80	
Electromagnetic brake model	60×60×135.8	8 (20)	35	1:100	–	PBM603DHMK50	PB4D003P340	p. 60	p. 80	
	28×28×98.5	0.055	–	–	–	PBM281DCE50	PB4D003P340	p. 61	p. 81	
	28×28×117.8	0.115	–	–	–	PBM285DCE50	PB4D003P340	p. 61	p. 81	
	42×42×88.3	0.39	–	–	–	PBM423DCK50	PB4D003P340	p. 61	p. 81	
	60×60×108.1	1.05	–	–	–	PBM603DCK50	PB4D003P340	p. 61	p. 81	
	60×60×140.1	1.85	–	–	–	PBM604DCK50	PB4D003P340	p. 61	p. 81	

* Numbers in parenthesis following allowable torques indicate allowable instantaneous torques.

Options and Peripherals

Product names	Standard model number (length)	Connector set model number	Extendable max. length	Remarks	Page
① Power cable	PBC10P0010A (1 m)	PBC10P0000A	2 m **	–	p. 90
	PBC10P0020A (2 m)				
② Power cable (between drivers)	PBC10P0002B (0.2 m)	PBC10P0000A	2 m **	Used when multiple axes are connected in a daisy chain configuration for communication.	p. 90
③ Motor extension cable	PBC8M0010A (1 m)	PBC8M0000A	20 m	An extension cable is required when the distance between the motor and driver exceeds 50 cm.	p. 91
	PBC8M0030A (3 m)				
	PBC8M0050A (5 m)				
④ Encoder extension cable	PBC7E0010A (1 m)	PBC7E0000A	20 m	An extension cable is required when the distance between the motor and driver exceeds 50 cm.	p. 91
	PBC7E0030A (3 m)				
	PBC7E0050A (5 m)				
⑤ I/O signal cable	PBC8S0010C (1 m)	PBC8S0000C	2 m	–	p. 92
⑥ Communications converter unit	PBFM-U6	–	–	A set of a converter (USB/RS-485) and a cable	p. 86
⑦ Setup software	SANMOTION MOTOR SETUP SOFTWARE	–	–	Software for checking operation and parameter setting	p. 85
⑧ Regenerative unit	PBFE-02	–	–	–	p. 92

** The total extended length to the furthest driver from the power supply should not exceed this length.

Driver Dimensions Unit: mm

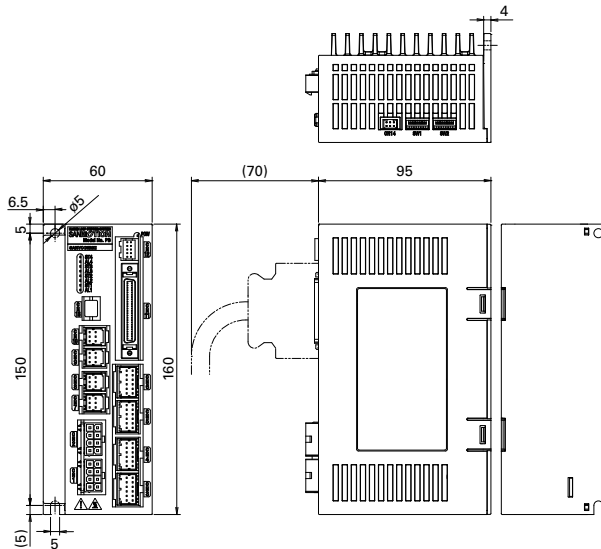

Driver Specifications

General specifications

Basic specifications	Model number	PB4D003P340		
	Interface	Pulse train input		
	Input power supply	Main circuit power supply: 24/48 VDC ±10% Control circuit power supply: 24 VDC ±10%		
	Number of control axes	4 axes		
	Power supply current	14 A		
	Environment	Protection class	Class III	
		Operation environment	Pollution degree: 2	
		Operating ambient temperature	0 to +55°C	
		Storage temperature	-20 to +65°C	
		Operating ambient humidity	90% RH max. (non-condensing)	
Storage humidity		90% RH max. (non-condensing)		
Operation altitude		1000 m or less above sea level		
Vibration resistance		Tested under the following conditions: Acceleration: 5 m/s ² , Frequency range: 10 to 55 Hz, Axes of vibration: X, Y, Z (2 hours each)		
Functions	Impact resistance	20 m/s ²		
	Dielectric strength	No error observed when 1.1 kVAC is applied between power input terminal and frame for one minute.		
	Insulation resistance	10 MΩ min. when measured with a 500 VDC megohmmeter between input terminal and frame.		
	Mass	0.7 kg		
	Max. rotational speed	4500 min ⁻¹ , 3000 min ⁻¹ for 60 mm sq. motors		
	Command resolution (P/R)	200, 400, 800, 1000, 1600, 2000, 3200, 5000, 6400, 10000, 12800, 20000, 25000, 25600, 50000, 51200 Can be used together with electronic gear function*		
	Holding brake control function	Built in		
	Protection functions	Main circuit overcurrent, overload error, initialization error, driver overheat, main circuit overvoltage, regeneration error, main circuit low voltage, control circuit low voltage, encoder disconnection, overspeed error, position deviation error, wrap around, memory error, CPU peripheral circuit error		
	Display / Indication	LED Indicators		
	Operating functions	Auto homing mode operation / Push (current control) operation / S-shape operation function		
I/O signal	DIP switch	SW1: Setting of 1 and 2 motor axes SW2: Setting of 3 and 4 motor axes		
	PC interface	RS-485 Start / stop synchronization, half-duplex communication Baud rate: 57600 bps		
	Pulse input signal	Photocoupler input method, input resistance: 200 Ω Input signal voltage: "H": 3.0 to 5.5 VDC; "L": 0 to 0.5 VDC Maximum input frequency: 400 kpulse/s		
	Input signal	Photocoupler input method, input resistance: 2.2 kΩ Input signal voltage: "H": 4.0 to 26.4 VDC; "L": 0 to 1.0 VDC Number of inputs: 13		
Output signal	Open collector output by photocoupler Output signal standard: Vce=4.75 to 26.4 V, Ic=10 mA max. Number of outputs: 13			

*A function that finely adjusts the unit step angle per pulse parameters. Setup software is required.

Safety standards

CE (TÜV)	Directives	Standard	
	Low-voltage directives	EN 61800-5-1	
	EMC directives	EN 61000-6-2, EN 61800-3, EN 61000-6-4	
UL	Acquired standards	Applicable standard	File no.
	UL	UL 508C	E179775
	cUL		
KC Mark (Korea Certification Mark)	Standard	KN 61000-6-2, KN 61000-6-4	

External Wiring Diagram

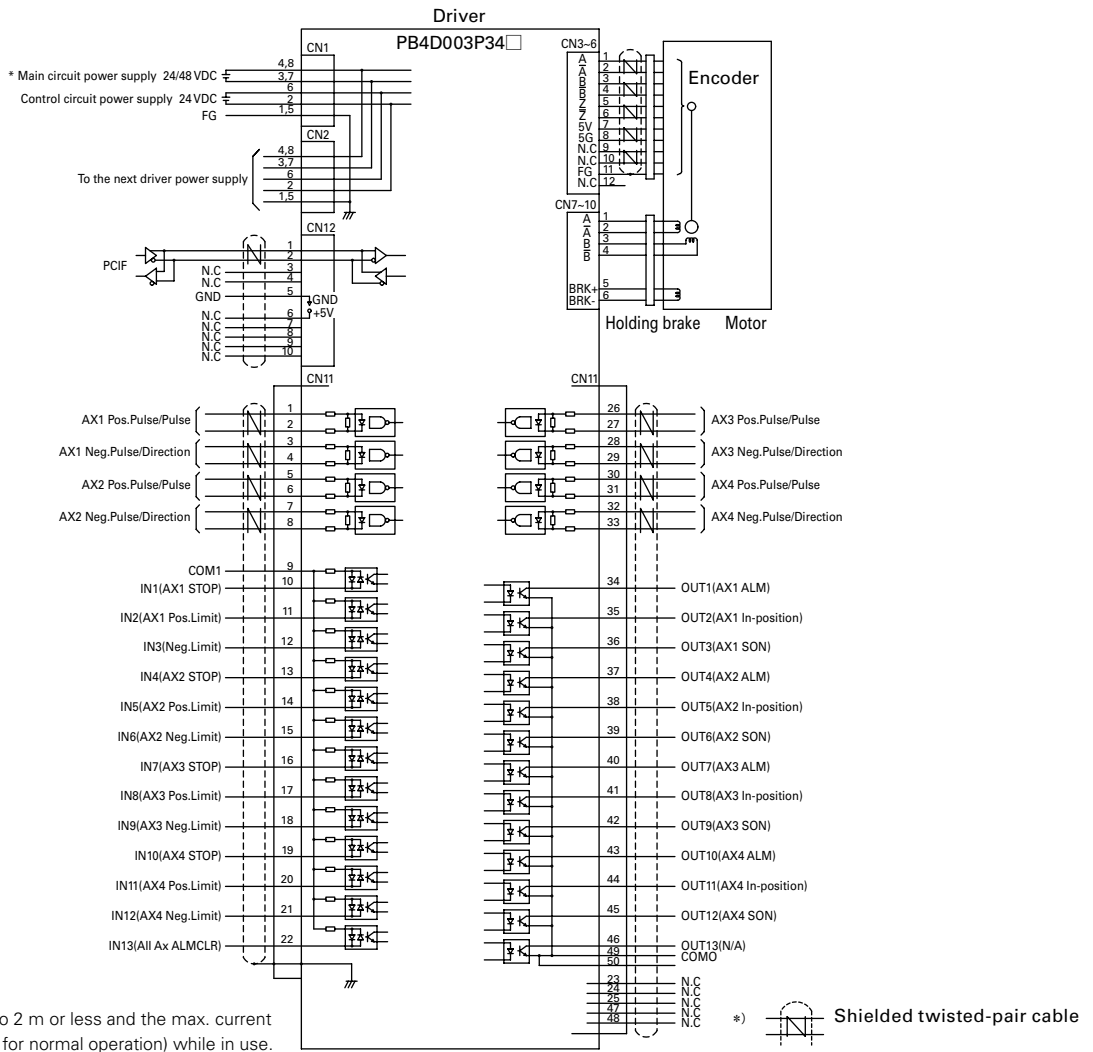

* Keep the max. extended length to 2 m or less and the max. current consumption to 14 A or less (7 A for normal operation) while in use.

Wiring

Connector Models and Compatible Cables

Application	Connector no.	Description	Manufacturer model number	Compatible cables	Maximum extension length	Manufacturer
Power supply	CN1 CN2	Header (driver side)	5569-08A2	AWG16 to 24 Discrete line	2 m	Molex Japan Co., Ltd.
		Housing	5557-08R-210			
		Terminal	5556T3 (AWG16 linked)			
			5556T3L (AWG16 single)			
			5556T (AWG18 to 24 linked)			
Motor	CN7 to CN10	Tab header (driver side)	2-1827876-3	AWG18 to 22 Discrete line	20 m	Tyco Electronics Japan G.K.
		Receptacle housing	2-1827864-3			
		Receptacle contact	1827572-2 (AWG18 to 22)			
		Tab housing (for relay)	2-1903130-3			
		Tab contact (for relay)	1903114-2 (AWG18 to 22)			
Encoder	CN3 to CN6	Tab header (driver side)	1-1827876-6	AWG22 to 28 Shielded twisted pair	20 m	Tyco Electronics Japan G.K.
		Receptacle housing	1-1827864-6			
		Receptacle contact	1827570-2 (AWG22 to 28)			
		Tab housing (for relay)	1-1903130-6			
		Tab contact (for relay)	1903112-2 (AWG22 to 28)			
I/O signals	CN11	Receptacle (driver side)	DF02R050NA1	AWG24 to 30 Shielded discrete line	2 m	Japan Aviation Electronics Industry, Ltd.
		Shell kit	10350-52A0-008			3M Japan Limited
		Plug	10150-3000PE			
Communications	CN12	Post with base (driver side)	S10B-PADSS-1GW	AWG24 to 28 Shielded twisted pair	2 m	J.S.T.
		Housing	PADP-10V-1-S			
		Contact	SPH-002GW-P0.5S			

- Refer to the manufacturer's catalog for detailed connector specifications.
- If the maximum extended length is exceeded, take necessary countermeasures to prevent malfunctions due to line noise.
- The relay connector is used to connect to the motor or encoder side connector when creating an extension cable.

Driver Components and Functions

(Driver upper section)

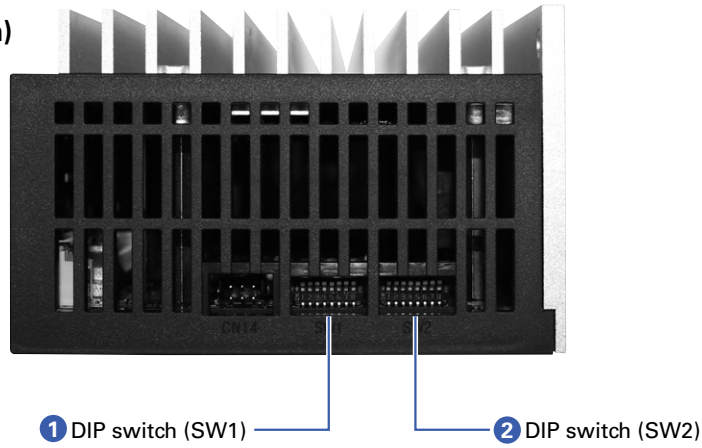

1 DIP switch (SW1)

Allows motors to be used for the 1st and 2nd axes.

SW No.	1	2	3	4	5	6	7	8
Code	M.SEL1-1	M.SEL1-2	M.SEL1-3	M.SEL1-4	M.SEL2-1	M.SEL2-2	M.SEL2-3	M.SEL2-4
Function	Allows motors to be used for the 1st axis.				Allows motors to be used for the 2nd axis.			

2 DIP switch (SW2)

Allows motors to be used for the 3rd and 4th axes.

SW No.	1	2	3	4	5	6	7	8
Code	M.SEL3-1	M.SEL3-2	M.SEL3-3	M.SEL3-4	M.SEL4-1	M.SEL4-2	M.SEL4-3	M.SEL4-4
Function	Allows motors to be used for the 3rd axis.				Allows motors to be used for the 4th axis.			

Switch ON/OFF combinations for each motor model

M.SELx-1	M.SELx-2	M.SELx-3	M.SELx-4	Motor model number
OFF	OFF	OFF	OFF	PBM281DXE50
ON	OFF	OFF	OFF	PBM285DXE50
OFF	ON	OFF	OFF	Setting prohibited
ON	ON	OFF	OFF	Reserved
OFF	OFF	ON	OFF	Setting prohibited
ON	OFF	ON	OFF	Setting prohibited
OFF	ON	ON	OFF	Reserved
ON	ON	ON	OFF	Reserved
OFF	OFF	OFF	ON	Setting prohibited
ON	OFF	OFF	ON	Setting prohibited
OFF	ON	OFF	ON	Setting prohibited
ON	ON	OFF	ON	PBM423DXK50
OFF	OFF	ON	ON	Setting prohibited
ON	OFF	ON	ON	Setting prohibited
OFF	ON	ON	ON	PBM603DXK50
ON	ON	ON	ON	PBM604DXK50

- The factory settings are OFF for all switches. (Setting for PBM281DXE50)
- Change switch settings while the power supply is off.
- Settings cannot be changed while the power is on.



Size	Motor size	28 mm sq.		42 mm sq.	60 mm sq.	
	Motor length	59.2 mm	78.5 mm	55.9 mm	68.8 mm	100.8 mm
Motor model number		PBM281DXE50	PBM285DXE50	PBM423DXK50	PBM603DXK50	PBM604DXK50
Compatible driver model number		PB4D003P340	PB4D003P340	PB4D003P340	PB4D003P340	PB4D003P340
Max. stall torque	N·m	0.055	0.115	0.39	1.05	1.85
Rotor inertia	$\times 10^{-4} \text{kg}\cdot\text{m}^2$	0.01	0.022	0.056	0.4	0.84
Allowable thrust load	N	10	10	9.8	14.7	14.7
Allowable radial load *	N	26	26	48	120	120
Motor mass	kg	0.16	0.26	0.35	0.85	1.42
Characteristics diagram		①	②	③	④	⑤

● Maintain motor surface temperature at 85°C or lower while in use.
 * The load point is at the end of the output shaft.

Characteristics diagram

Torque 24VDC — 48VDC — Power supply current 24VDC - - - 48VDC - - -

① Motor model number **PBM281DXE50**

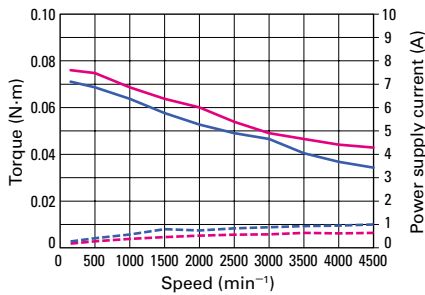

② Motor model number **PBM285DXE50**

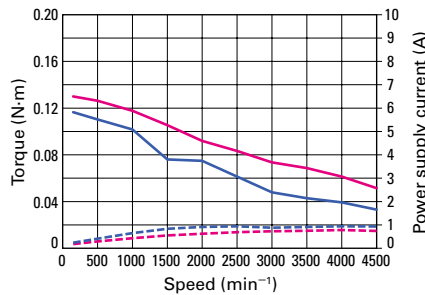

③ Motor model number **PBM423DXK50**

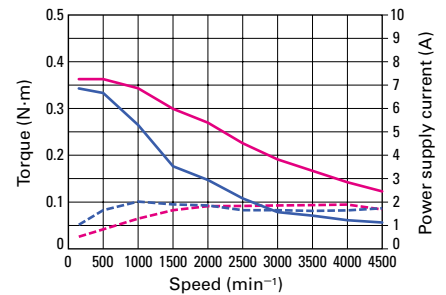

④ Motor model number **PBM603DXK50**

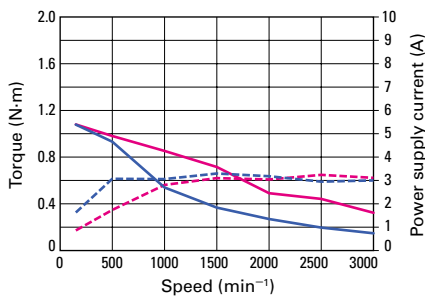

⑤ Motor model number **PBM604DXK50**

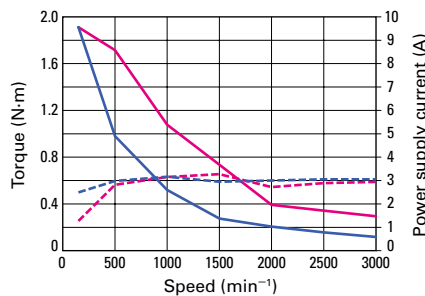

Low-backlash gear model

RoHS

Size	Motor size	42 mm sq.				
	Motor + gear length	86.1 mm				
Motor model number		PBM423DGAk50	PBM423DGBk50	PBM423DGEk50	PBM423DGGk50	PBM423DGJK50
Compatible driver model number		PB4D003P340	PB4D003P340	PB4D003P340	PB4D003P340	PB4D003P340
Allowable torque	N·m	0.343	0.686	0.98	1.47	1.47
Rotor inertia	$\times 10^{-4}$ kg·m ²	0.056	0.056	0.056	0.056	0.056
Gear ratio	—	1:3.6	1:7.2	1:10	1:20	1:30
Backlash	deg. or less	0.6	0.4	0.35	0.25	0.25
Allowable speed	min ⁻¹	500	250	180	90	60
Rotation direction	Relative to command direction	Forward	Forward	Forward	Reverse	Reverse
Allowable thrust load	N	15	15	15	15	15
Allowable radial load *	N	20	20	20	20	20
Motor mass	kg	0.48	0.48	0.48	0.48	0.48
Characteristics diagram		①	②	③	④	⑤

● Maintain motor surface temperature at 85°C or lower while in use.
 * When load is applied at 1/3 length from output shaft end.

Characteristics diagram

Allowable torque 24 VDC — 48 VDC — 24 VDC/48 VDC — Power supply current 24 VDC 48 VDC

① Motor model number **PBM423DGAk50**

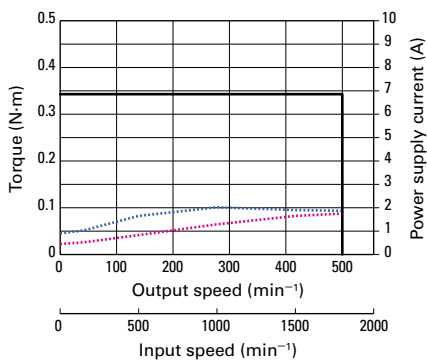

② Motor model number **PBM423DGBk50**

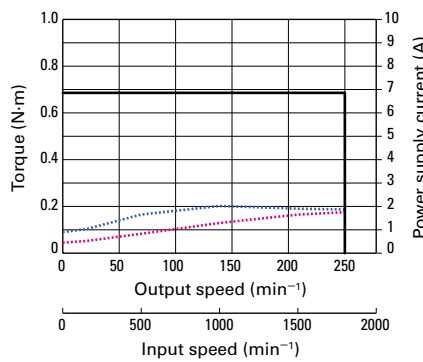

③ Motor model number **PBM423DGEk50**

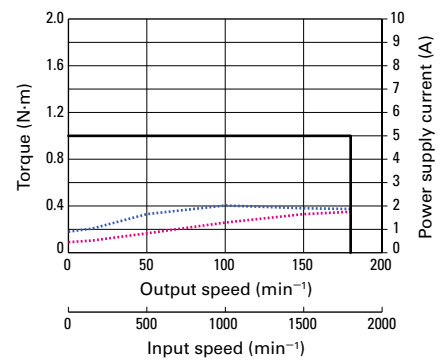

④ Motor model number **PBM423DGGk50**

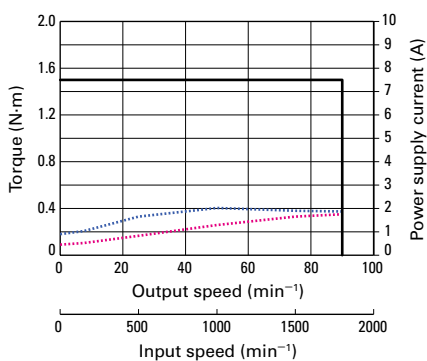

⑤ Motor model number **PBM423DGJK50**

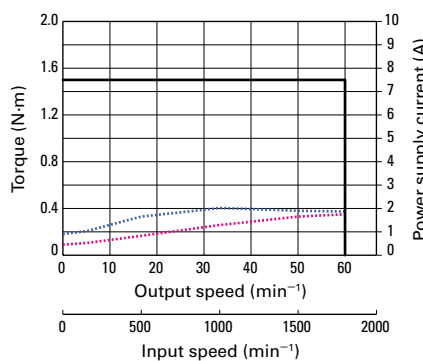

System Configuration Diagram ▶ p. 50 Compatible Driver / Motor Combinations ▶ p. 51 Driver Dimensions ▶ p. 52 Motor Dimensions ▶ pp. 79 to 81

When using a motor with low-backlash gear, exceeding the allowable torque might damage the gear. Carefully select products so that the configured system can operate within the specified limit value.

● Data for the above characteristics is based on SANYO DENKI's internal measurement conditions. Depending on conditions such as machine precision, driving torque may vary as well.

Size	Motor size	60 mm sq.				
	Motor + gear length	114.3 mm				
Motor model number		PBM603DGAK50	PBM603DGBK50	PBM603DGEK50	PBM603DGGK50	PBM603DGJK50
Compatible driver model number		PB4D003P340	PB4D003P340	PB4D003P340	PB4D003P340	PB4D003P340
Allowable torque	N·m	1.25	2.5	3	3.5	4
Rotor inertia	$\times 10^{-4} \text{kg}\cdot\text{m}^2$	0.4	0.4	0.4	0.4	0.4
Gear ratio	—	1:3.6	1:7.2	1:10	1:20	1:30
Backlash	deg. or less	0.55	0.25	0.25	0.17	0.17
Allowable speed	min^{-1}	500	250	180	90	60
Rotation direction	Relative to command direction	Forward	Forward	Reverse	Reverse	Reverse
Allowable thrust load	N	30	30	30	30	30
Allowable radial load *	N	100	100	100	100	100
Motor mass	kg	1.22	1.22	1.22	1.22	1.22
Characteristics diagram		①	②	③	④	⑤

● Maintain motor surface temperature at 85°C or lower while in use.
 * When load is applied at 1/3 length from output shaft end.

Characteristics diagram

Allowable torque 24 VDC — 48 VDC — 24 VDC/48 VDC — Power supply current 24 VDC 48 VDC

① Motor model number **PBM603DGAK50**

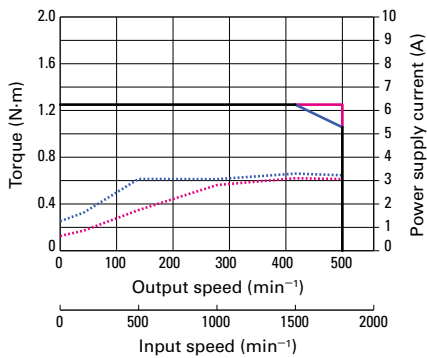

② Motor model number **PBM603DGBK50**

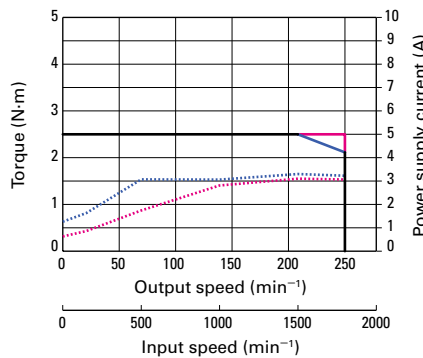

③ Motor model number **PBM603DGEK50**

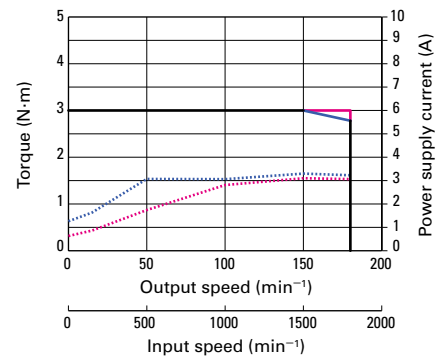

④ Motor model number **PBM603DGGK50**

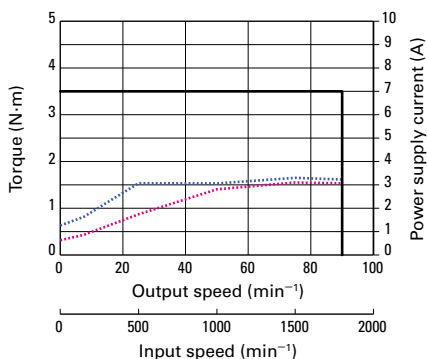

⑤ Motor model number **PBM603DGJK50**

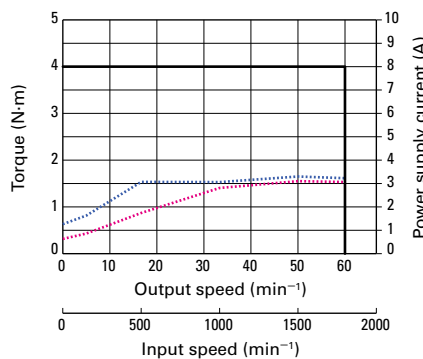

Spur gear model

Size	Motor size	28 mm sq.					
	Motor + gear length	88.6 mm					
Motor model number		PBM281DGAE50	PBM281DGBE50	PBM281DGEE50	PBM281DGGE50	PBM281DGJE50	PBM281DGLE50
Compatible driver model number		PB4D003P340	PB4D003P340	PB4D003P340	PB4D003P340	PB4D003P340	PB4D003P340
Allowable torque	N·m	0.1	0.15	0.2	0.35	0.5	0.5
Rotor inertia	$\times 10^{-4}$ kg·m ²	0.01	0.01	0.01	0.01	0.01	0.01
Gear ratio	—	1:3.6	1:7.2	1:10	1:20	1:30	1:50
Backlash	deg. or less	2	2	2	1.5	1.5	1.5
Allowable speed	min ⁻¹	800	400	300	150	100	60
Rotation direction	Relative to command direction	Forward	Forward	Reverse	Forward	Forward	Forward
Allowable thrust load	N	10	10	10	10	10	10
Allowable radial load *	N	15	15	15	15	15	15
Motor mass	kg	0.22	0.22	0.22	0.22	0.22	0.22
Characteristics diagram		①	②	③	④	⑤	⑥

● Maintain motor surface temperature at 85°C or lower while in use.
 * When load is applied at 1/3 length from output shaft end.

Characteristics diagram

Allowable torque 24VDC/48VDC ——— Power supply current 24VDC 48VDC

① Motor model number **PBM281DGAE50**

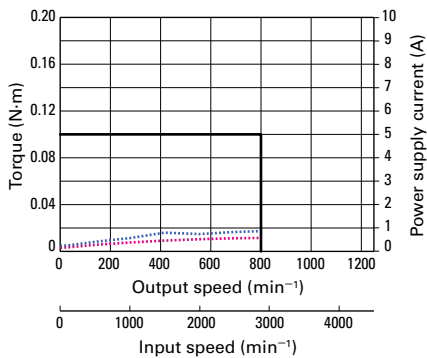

② Motor model number **PBM281DGBE50**

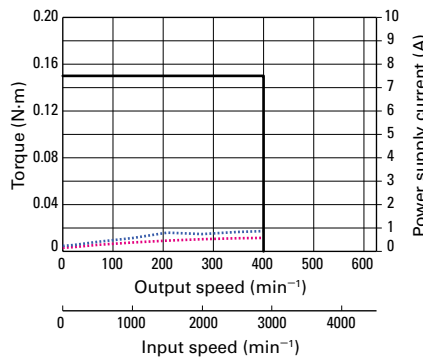

③ Motor model number **PBM281DGEE50**

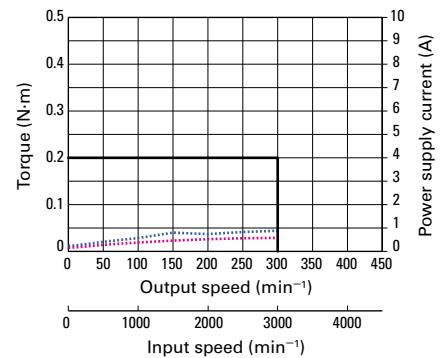

④ Motor model number **PBM281DGGE50**

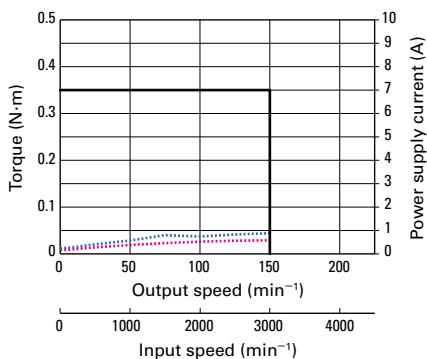

⑤ Motor model number **PBM281DGJE50**

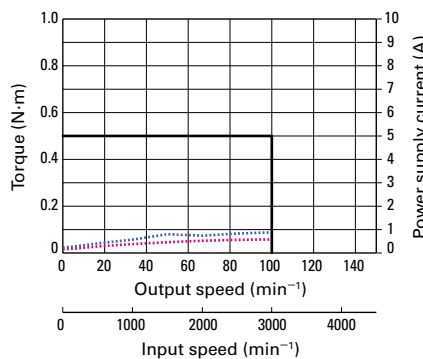

⑥ Motor model number **PBM281DGLE50**

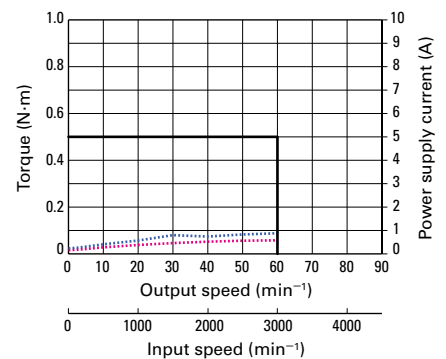

Size	Motor size	28 mm sq.		42 mm sq.		
	Motor + gear length	97.7 mm		95.1 mm		
Motor model number		PBM281DHLE50	PBM281DHME50	PBM423DHJK50	PBM423DHLK50	PBM423DHMK50
Compatible driver model number		PB4D003P340	PB4D003P340	PB4D003P340	PB4D003P340	PB4D003P340
Allowable torque	N·m	1.5	2	2.2	3.5	5
Allowable instantaneous torque	N·m	2.6	3.6	4.5	8.3	11
Rotor inertia	×10 ⁻⁴ kg·m ²	0.013	0.013	0.068	0.068	0.068
Gear ratio	—	1:50	1:100	1:30	1:50	1:100
Hysteresis loss	Arc min or less	—	—	3.6	2.4	2.4
Lost motion	Arc min	0.4 to 3 (at ±0.06 N·m)	0.4 to 3 (at ±0.08 N·m)	—	—	—
Allowable speed	min ⁻¹	70	35	116	70	35
Rotation direction	Relative to command direction	Reverse	Reverse	Reverse	Reverse	Reverse
Allowable thrust load	N	100	100	1150	1150	1150
Allowable radial load *	N	160	160	275	275	275
Motor mass	kg	0.27	0.27	0.54	0.54	0.54
Characteristics diagram		①	②	③	④	⑤

● Maintain motor surface temperature at 85°C or lower while in use.
* When load is applied at 1/3 length from output shaft end.

Characteristics diagram

Allowable torque 24 VDC — 48 VDC — 24 VDC/48 VDC —
 Allowable instantaneous torque 24 VDC - - - 48 VDC - - - 24 VDC/48 VDC - - -
 Power supply current 24 VDC 48 VDC

① Motor model number **PBM281DHLE50**

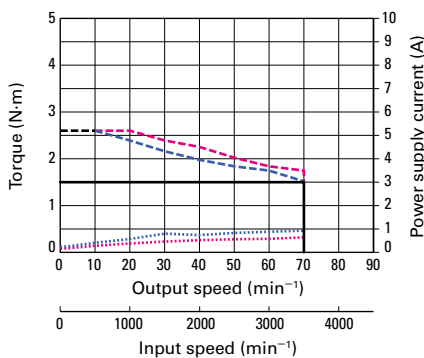

② Motor model number **PBM281DHME50**

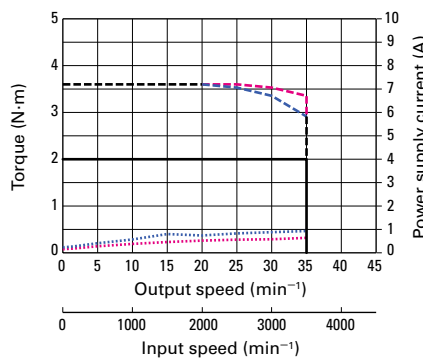

③ Motor model number **PBM423DHJK50**

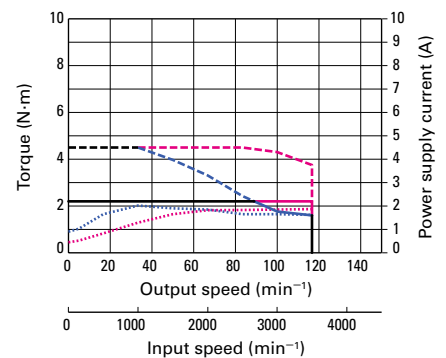

④ Motor model number **PBM423DHLK50**

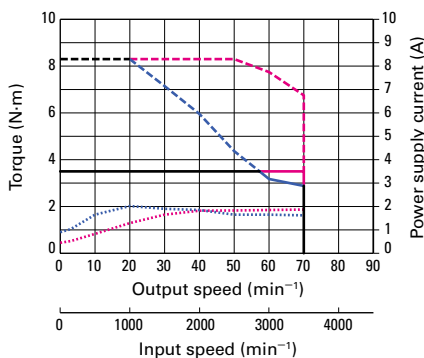

⑤ Motor model number **PBM423DHMK50**

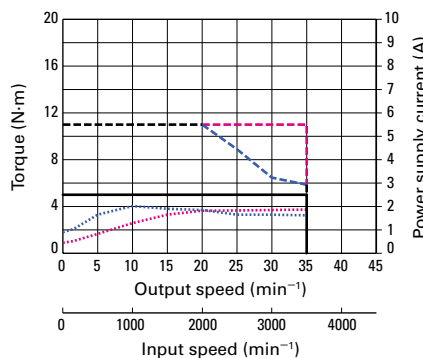

System Configuration Diagram ▶ p. 50 Compatible Driver / Motor Combinations ▶ p. 51 Driver Dimensions ▶ p. 52 Motor Dimensions ▶ pp. 79 to 81

When using a motor with harmonic gear, exceeding the allowable instantaneous torque might damage the gear. Carefully select products so that the configured system can operate within the specified limit value.

● Data for the above characteristics is based on SANYO DENKI's internal measurement conditions. Depending on conditions such as machine precision, driving torque may vary as well.

Harmonic gear model

RoHS

Size	Motor size	60 mm sq.	
	Motor + gear length	135.8 mm	
Motor model number		PBM603DHLK50	PBM603DHMK50
Compatible driver model number		PB4D003P340	PB4D003P340
Allowable torque	N·m	5.5	8
Allowable instantaneous torque	N·m	14	20
Rotor inertia	×10 ⁻⁴ kg·m ²	0.435	0.435
Gear ratio	—	1:50	1:100
Hysteresis loss	Arc min or less	—	—
Lost motion	Arc min	0.4 to 3 (at ±0.28 N·m)	0.4 to 1.5 (at ±0.4 N·m)
Allowable speed	min ⁻¹	70	35
Rotation direction	Relative to command direction	Reverse	Reverse
Allowable thrust load	N	400	400
Allowable radial load *	N	360	360
Motor mass	kg	1.45	1.45
Characteristics diagram		①	②

● Maintain motor surface temperature at 85°C or lower while in use.
* When load is applied at 1/3 length from output shaft end.

Characteristics diagram

Allowable torque 24 VDC — 48 VDC — 24 VDC/48 VDC —
Allowable instantaneous torque 24 VDC - - - 48 VDC - - - 24 VDC/48 VDC - - - Power supply current 24 VDC 48 VDC

① Motor model number **PBM603DHLK50**

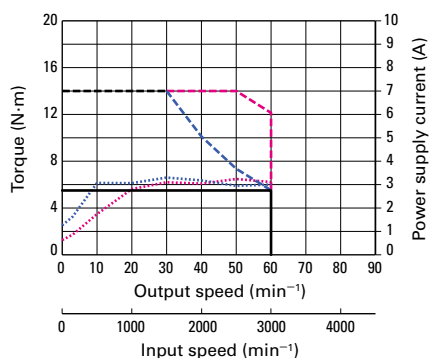

② Motor model number **PBM603DHMK50**

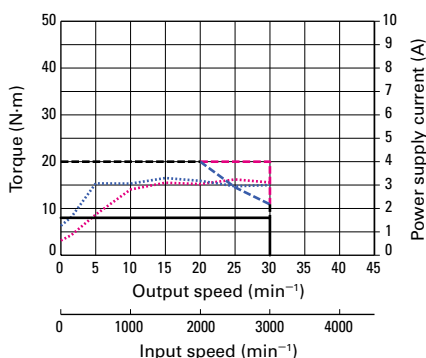

System Configuration Diagram ▶ p. 50 Compatible Driver / Motor Combinations ▶ p. 51 Driver Dimensions ▶ p. 52 Motor Dimensions ▶ pp. 79 to 81

When using a motor with harmonic gear, exceeding the allowable instantaneous torque might damage the gear. Carefully select products so that the configured system can operate within the specified limit value.

● Data for the above characteristics is based on SANYO DENKI's internal measurement conditions. Depending on conditions such as machine precision, driving torque may vary as well.

Size	Motor size		28 mm sq.		42 mm sq.	60 mm sq.		
	Motor + brake length		98.5 mm	117.8 mm	88.3 mm	108.1 mm	140.1 mm	
Motor model number			PBM281DCE50	PBM285DCE50	PBM423DCK50	PBM603DCK50	PBM604DCK50	
Compatible driver model number			PB4D003P340	PB4D003P340	PB4D003P340	PB4D003P340	PB4D003P340	
Max. stall torque		N·m	0.055	0.115	0.39	1.05	1.85	
Rotor inertia		$\times 10^{-4} \text{kg}\cdot\text{m}^2$	0.011	0.023	0.071	0.559	1.0	
Allowable thrust load		N	9.8	9.8	9.8	14.7	14.7	
Allowable radial load *		N	26	26	48	120	120	
Motor mass		kg	0.28	0.35	0.5	1.19	1.76	
Electromagnetic brake	Brake type		No excitation actuating type		No excitation actuating type		No excitation actuating type	
	Power supply voltage		24 VDC \pm 5%		24 VDC \pm 5%		24 VDC \pm 5%	
	Power consumption		3.6 (at 20°C)		2.4 (at 75°C)		6 (at 75°C)	
	Static friction torque		N·m or over		0.3		0.8	
	Brake operating time		ms or less		20		20	
Brake release time		ms or less		20		30		
Characteristics diagram			①	②	③	④	⑤	

● Maintain motor surface temperature at 85°C or lower while in use.
 * The load point is at the end of the output shaft.

Characteristics diagram

Torque 24 VDC — 48 VDC — Power supply current 24 VDC - - - 48 VDC - - -

① Motor model number **PBM281DCE50**

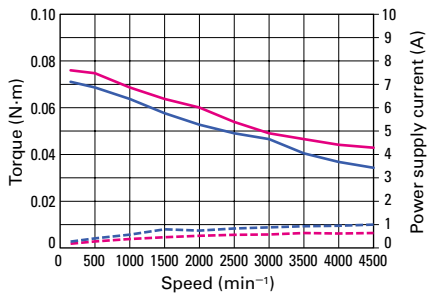

② Motor model number **PBM285DCE50**

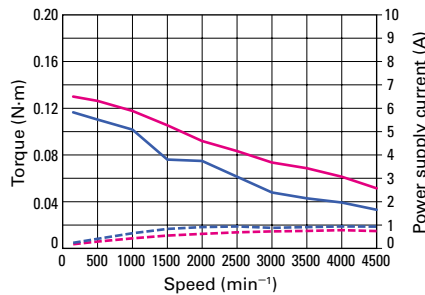

③ Motor model number **PBM423DCK50**

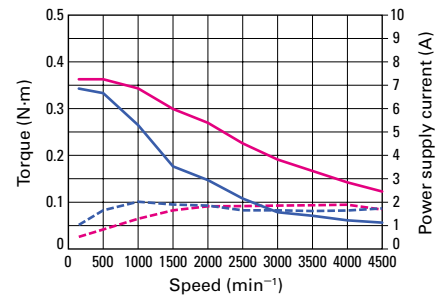

④ Motor model number **PBM603DCK50**

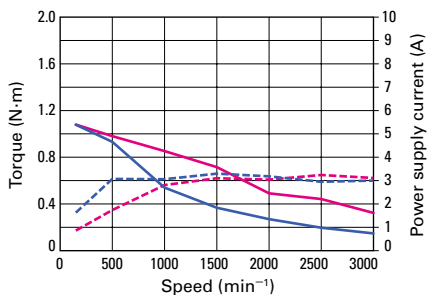

⑤ Motor model number **PBM604DCK50**

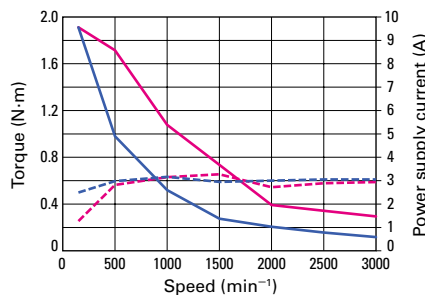

DC Input Drivers / Motors

Type E Multi-axis EtherCAT interface



Lineup **RoHS**

Motor

Motor size: 28 mm sq., 42 mm sq., 60 mm sq.

Driver **CE** **RoHS** **cULus** **UL**

Model number: PB4D003E440
 Input power supply: 24/48 VDC
 Number of control axes: 4

Compatible Driver / Motor Combinations ▶ p. 63 Driver Dimensions ▶ p. 64
 Driver Specifications ▶ p. 64 Specifications / Characteristics Diagram ▶ pp. 67 to 78
 Motor Dimensions ▶ pp. 79 to 83 Motor Specifications ▶ p. 84

System Configuration Diagram

24/48 VDC

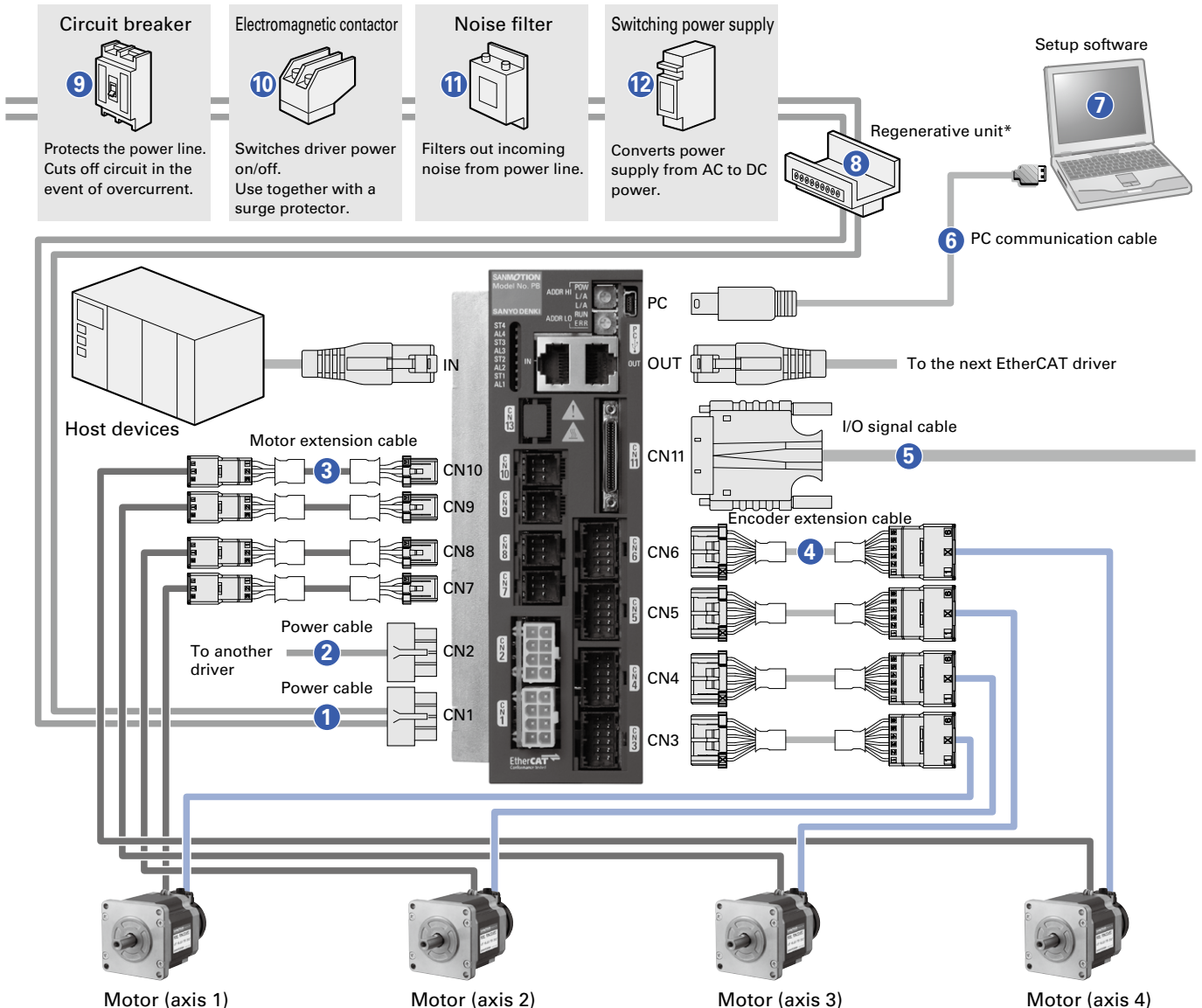

* Connect the regenerative unit when a 60 mm sq. motor is used. Check the voltage while in operation. To be provided by the customer. 9 to 12

Compatible Driver / Motor Combinations

No set models are available with this driver. Since this driver is capable of controlling multiple axes, order the necessary number of motors.

Model	Motor external dimensions Flange size × Motor length (mm)		Max. stall torque (allowable torque* for models with gear) (N·m)	Allowable speed (min ⁻¹)	Gear ratio	Backlash (deg.)	Motor model number		Driver model number	Page	
	Optical incremental encoder	Battery-less optical absolute encoder					Optical incremental encoder	Battery-less optical absolute encoder		Specifications	Motor dimensions
Standard model	28×28×59.2	—	0.055	—	—	—	PBM281DXE50	—	PB4D003E440	p. 67	p. 79
	28×28×78.5	—	0.115	—	—	—	PBM285DXE50	—		p. 67	p. 79
	42×42×55.9	42×42×74.7	0.39	—	—	—	PBM423DXK50	PBM423DXR50		pp. 67, 74	pp. 79, 82
	60×60×68.8	60×60×87.6	1.05	—	—	—	PBM603DXK50	PBM603DXR50		pp. 67, 74	pp. 79, 82
	60×60×100.8	60×60×119.6	1.85	—	—	—	PBM604DXK50	PBM604DXR50		pp. 67, 74	pp. 79, 82
Low-backlash gear model	42×42×86.1	42×42×104.9	0.343	500	1:3.6	0.6	PBM423DGAK50	PBM423DGAR50		pp. 68, 75	pp. 79, 82
	42×42×86.1	42×42×104.9	0.686	250	1:7.2	0.4	PBM423DGBK50	PBM423DGBR50		pp. 68, 75	pp. 79, 82
	42×42×86.1	42×42×104.9	0.98	180	1:10	0.35	PBM423DGK50	PBM423DGER50		pp. 68, 75	pp. 79, 82
	42×42×86.1	42×42×104.9	1.47	90	1:20	0.25	PBM423DGGK50	PBM423DGGR50		pp. 68, 75	pp. 79, 82
	42×42×86.1	42×42×104.9	1.47	60	1:30	0.25	PBM423DGJK50	PBM423DGJR50		pp. 68, 75	pp. 79, 82
	60×60×114.3	60×60×133.1	1.25	500	1:3.6	0.55	PBM603DGAK50	PBM603DGAR50		pp. 69, 76	pp. 79, 82
	60×60×114.3	60×60×133.1	2.5	250	1:7.2	0.25	PBM603DGBK50	PBM603DGBR50	pp. 69, 76	pp. 79, 82	
	60×60×114.3	60×60×133.1	3	180	1:10	0.25	PBM603DGK50	PBM603DGER50	pp. 69, 76	pp. 79, 82	
	60×60×114.3	60×60×133.1	3.5	90	1:20	0.17	PBM603DGGK50	PBM603DGGR50	pp. 69, 76	pp. 79, 82	
	60×60×114.3	60×60×133.1	4	60	1:30	0.17	PBM603DGJK50	PBM603DGJR50	pp. 69, 76	pp. 79, 82	
Spur gear model	28×28×88.6	—	0.1	800	1:3.6	2	PBM281DGAE50	—	p. 70	p. 80	
	28×28×88.6	—	0.15	400	1:7.2	2	PBM281DGBE50	—	p. 70	p. 80	
	28×28×88.6	—	0.2	300	1:10	2	PBM281DGE50	—	p. 70	p. 80	
	28×28×88.6	—	0.35	150	1:20	1.5	PBM281DGG50	—	p. 70	p. 80	
	28×28×88.6	—	0.5	100	1:30	1.5	PBM281DGJE50	—	p. 70	p. 80	
	28×28×88.6	—	0.5	60	1:50	1.5	PBM281DGLE50	—	p. 70	p. 80	
Harmonic gear model	28×28×97.7	—	1.5 (2.6)	70	1:50	—	PBM281DHLE50	—	p. 71	p. 80	
	28×28×97.7	—	2 (3.6)	35	1:100	—	PBM281DHME50	—	p. 71	p. 80	
	42×42×95.1	42×42×113.9	2.2 (4.5)	116	1:30	—	PBM423DHJK50	PBM423DHJR50	pp. 71, 77	pp. 80, 82	
	42×42×95.1	42×42×113.9	3.5 (8.3)	70	1:50	—	PBM423DHLK50	PBM423DHLR50	pp. 71, 77	pp. 80, 82	
	42×42×95.1	42×42×113.9	5 (11)	35	1:100	—	PBM423DHMK50	PBM423DHMR50	pp. 71, 77	pp. 80, 82	
	60×60×135.8	60×60×154.6	5.5 (14)	70	1:50	—	PBM603DHLK50	PBM603DHLR50	pp. 72, 77	pp. 80, 83	
Electromagnetic brake model	60×60×135.8	60×60×154.6	8 (20)	35	1:100	—	PBM603DHMK50	PBM603DHMR50	pp. 72, 77	pp. 80, 83	
	28×28×98.5	—	0.055	—	—	—	PBM281DCE50	—	p. 73	p. 81	
	28×28×117.8	—	0.115	—	—	—	PBM285DCE50	—	p. 73	p. 81	
	42×42×88.3	42×42×107.4	0.39	—	—	—	PBM423DCK50	PBM423DCR50	pp. 73, 78	pp. 81, 83	
	60×60×108.1	60×60×126.9	1.05	—	—	—	PBM603DCK50	PBM603DCR50	pp. 73, 78	pp. 81, 83	
	60×60×140.1	60×60×158.9	1.85	—	—	—	PBM604DCK50	PBM604DCR50	pp. 73, 78	pp. 81, 83	

* Numbers in parenthesis following allowable torques indicate allowable instantaneous torques.

Options and Peripherals

Product names	Standard model number (length)	Connector set model number	Extendable max. length	Remarks	Page
① Power cable	PBC10P0010A (1 m)	PBC10P0000A	2 m **	—	p. 90
	PBC10P0020A (2 m)				
② Power cable (between drivers)	PBC10P0002B (0.2 m)	PBC10P0000A	2 m **	Used when multiple axes are connected in a daisy chain configuration for communication.	p. 90
③ Motor extension cable	PBC8M0010A (1 m)	PBC8M0000A	20 m	An extension cable is required when the distance between the motor and driver exceeds 50 cm.	p. 91
	PBC8M0030A (3 m)				
	PBC8M0050A (5 m)				
④ Encoder extension cable	PBC7E0010A (1 m)	PBC7E0000A	20 m	An extension cable is required when the distance between the motor and driver exceeds 50 cm.	p. 91
	PBC7E0030A (3 m)				
	PBC7E0050A (5 m)				
⑤ I/O signal cable	PBC9S0010C (1 m)	PBC9S0000C	2 m	—	p. 93
⑥ PC communication cable	AL-00896515-01 (1 m)	—	—	PC communication cable for setup software	p. 93
	AL-00896515-02 (2 m)				
⑦ Setup software	SANMOTION MOTOR SETUP SOFTWARE	—	—	Software for checking operation and parameter setting	p. 85
⑧ Regenerative unit	PBFE-02	—	—	—	p. 92

** The total extended length to the furthest driver from the power supply should not exceed this length.

Driver Dimensions Unit: mm

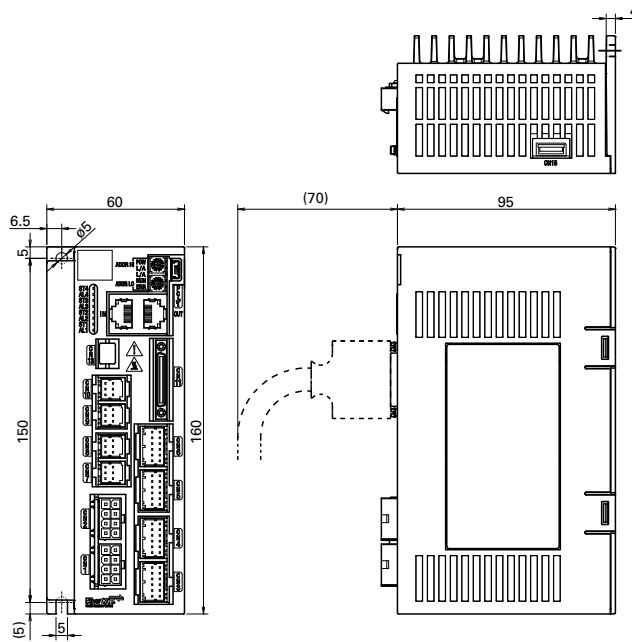

Driver Specifications

General specifications

Basic specifications	Model number		PB4D003E440
	Interface		EtherCAT communication
	Input power supply	Main circuit power supply	24/48 VDC ±10% 14A
		Control circuit power supply	24 VDC ±10% 1.5A
	Number of control axes		4 axes
	Environment	Protection rating	Class III
		Operating environment	Installation category (overvoltage category): I, Pollution degree: 2
Mass		0.7 kg	
Functions	Max. motor speed		4500 min ⁻¹ , (3000 min ⁻¹ for 60 mm sq. motor)
	Holding brake control function		Built in
	Protection functions		Main circuit overcurrent, overload error, initialization error, driver overheat, main circuit overvoltage, regeneration error, main circuit undervoltage, control circuit undervoltage, encoder disconnection, overspeed error, position deviation error, wrap around, memory error, CPU peripheral circuit error, communication error
	LED indicators		Power, Status, Alarm
	Rotary switch		Station alias setting
	Computer port		USB 2.0
EtherCAT interface	Physical layer / protocol		100BASE-TX / IEEE802.3 Fast Ethernet
	Bit rate		100 Mbit/s (Full duplex)
	Communication port / Topology		RJ45 connector (2 ports) / Daisy chain (max. 65535 nodes)
	Device profile		Device profile: CoE (IEC 61800-7-201), FoE (ASCII code access)
	Synchronization mode		SM2 event synchronization, DC synchronization (SYNC0/SYNC1), non-synchronized (asynchronous FreeRun mode) Minimum cycle time: 0.25 ms
I/O signal	Input signal		Photocoupler input method. Input resistance: 2.2 kΩ Input signal voltage: High-level: 4.0 to 26.4 VDC; Low-level: 0 to 1.0 VDC, Number of inputs: 16
	Output signal		Open collector output by photocoupler. Output signal standard: Vce=4.75 to 26.4 V, Ic=50 mA max. Number of outputs: 12

Safety standards

CE (TÜV)	Directive	Standard	
	Low-voltage directive	EN 61800-5-1	
	EMC directive	EN 61000-6-2, EN 61000-6-4, EN 61800-3	
UL	Acquired standards	Applicable standard	File No.
	UL	UL 508C	E179775
	cUL (UL for Canada)		
KC Mark (Korea Certification Mark)	Standard		
		KN 61000-6-2, KN 61000-6-4	

External Wiring Diagram

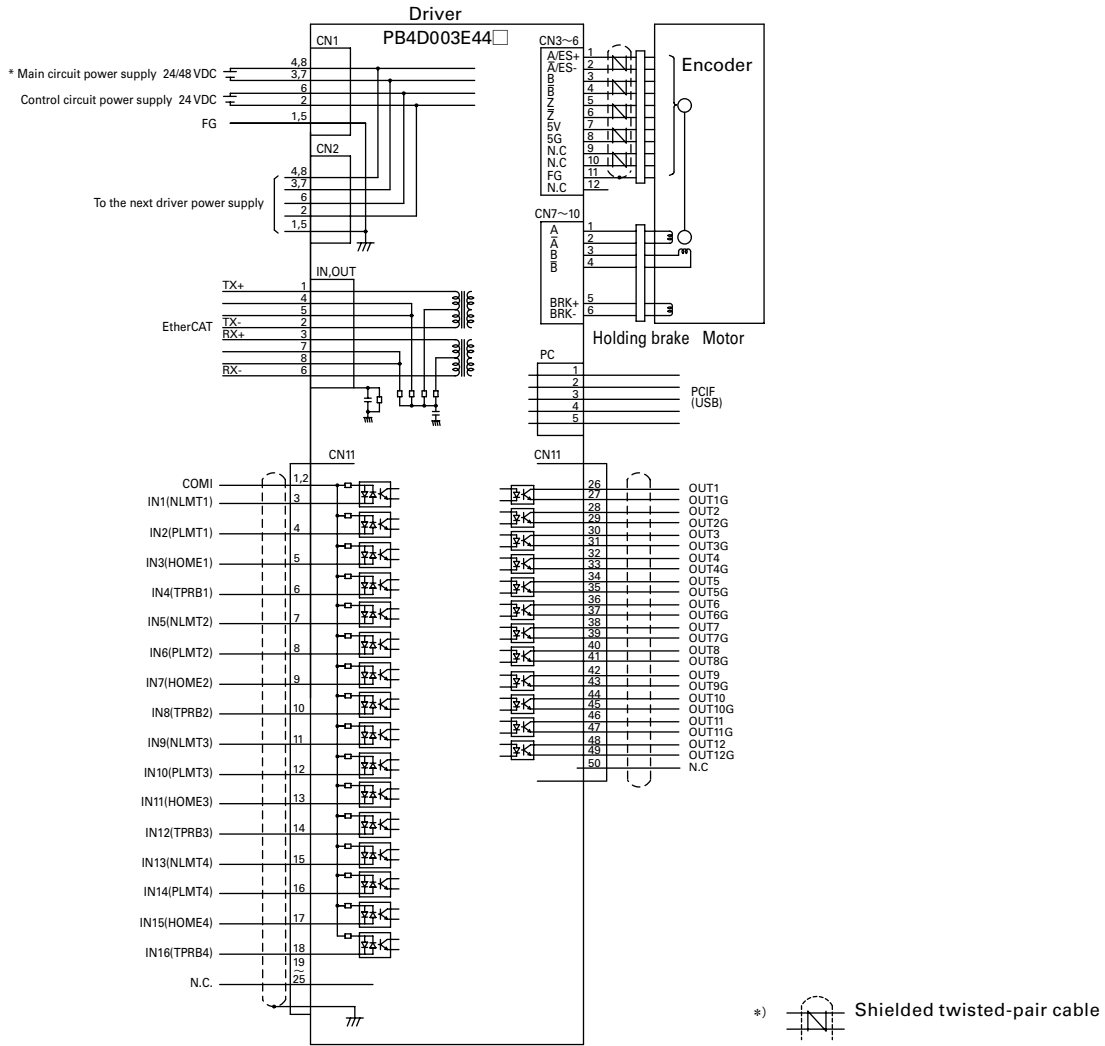

AC Input Set Models
Type R

AC Input Set Models
Type P

DC Input Set Models
Type M

DC Input Drivers / Motors
Type P, Multi-axis

DC Input Drivers / Motors
Type E, Multi-axis EtherCAT interface

Options

Wiring

Connector Models and Compatible Cables

Application	Connector no.	Description	Manufacturer model number	Compatible cables	Maximum extension length	Manufacturer
Power supply	CN1 CN2	Header (Driver side)	5569-08A2	AWG16 to 24 Discrete line	2 m	Molex Japan Co., Ltd.
		Housing	5557-08R-210			
		Terminal	5556T3 (AWG16 linked)			
			5556T3L (AWG16 single)			
			5556T (AWG18 to 24 linked)			
5556TL (AWG18 to 24 single)						
Power	CN7 to CN10	Tab header (Driver side)	2-1827876-3	AWG18 to 22 Discrete line	20 m	Tyco Electronics Japan G.K.
		Receptacle housing	2-1827864-3			
		Receptacle contact	1827572-2 (AWG18 to 22)			
		Tab housing (for relay)	2-1903130-3			
		Tab contact (for relay)	1903114-2 (AWG18 to 22)			
Encoder	CN3 to CN6	Tab header (Driver side)	1-1827876-6	AWG22 to 28 Shielded twisted pair	20 m	Tyco Electronics Japan G.K.
		Receptacle housing	1-1827864-6			
		Receptacle contact	1827570-2 (AWG22 to 28)			
		Tab housing (for relay)	1-1903130-6			
		Tab contact (for relay)	1903112-2 (AWG22 to 28)			
I/O signals	CN11	Connector (driver side)	HDR-EC50LFDT-SLD+	AWG30 (IDC (insulation displacement contact) type) AWG28 (Soldering type) Shielded discrete line	2 m	HONDATSUSHIN KOGYO CO., LTD.
		Plastic case	HDR-50LPH			
		Connector	HDR-E50MAG1+ (IDC (insulation displacement contact) type)			
			HDR-E50MSG1+ (Soldering type)			
EtherCAT	IN, OUT	Please connect to a host device and another driver via IN and OUT connectors, respectively. Please use a shielded twisted-pair (STP) cable in category 5e or better. As the ports support auto-crossover function called "auto MDI/MID-X", a feature that automatically detects the required cable connection type and configures the connection appropriately, either straight-through or crossover cable can be used.			Depends on the cable.	—
USB	PC	Commercially available USB cables (mini-B connector on driver side) can be used.			5 m	—

- Refer to the manufacturer's catalog for detailed connector specifications.
- If the maximum extended length is exceeded, take necessary countermeasures to prevent malfunctions due to line noise.
- When daisy-chaining a driver to another driver via CN1 and CN2 ports, please pay attention to the total current from the power supply. Keep it below 7 A when normally operating, and ensure it doesn't exceed 14 A even at peak time such as acceleration.
Also, the total extended cable length from a power supply to the furthest driver should not exceed the above length.

Size	Motor size	28 mm sq.		42 mm sq.	60 mm sq.	
	Motor length	59.2 mm	78.5 mm	55.9 mm	68.8 mm	100.8 mm
Motor model number		PBM281DXE50	PBM285DXE50	PBM423DXK50	PBM603DXK50	PBM604DXK50
Compatible driver model number		PB4D003E440	PB4D003E440	PB4D003E440	PB4D003E440	PB4D003E440
Max. stall torque	N·m	0.055	0.115	0.39	1.05	1.85
Rotor inertia	$\times 10^{-4}$ kg·m ²	0.01	0.022	0.056	0.4	0.84
Allowable thrust load	N	10	10	9.8	14.7	14.7
Allowable radial load *	N	26	26	48	120	120
Motor mass	kg	0.16	0.26	0.35	0.85	1.42
Characteristics diagram		①	②	③	④	⑤

● Maintain motor surface temperature at 85°C or lower while in use.
 * The load point is at the end of the output shaft.

Characteristics diagram

Torque 24VDC — 48VDC — Power supply current 24VDC - - - 48VDC - - -

① Motor model number **PBM281DXE50**

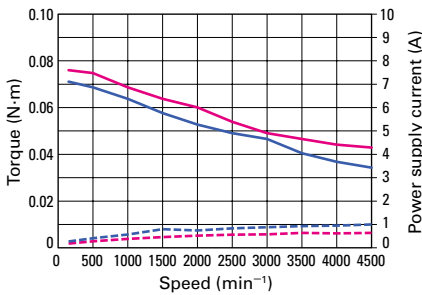

② Motor model number **PBM285DXE50**

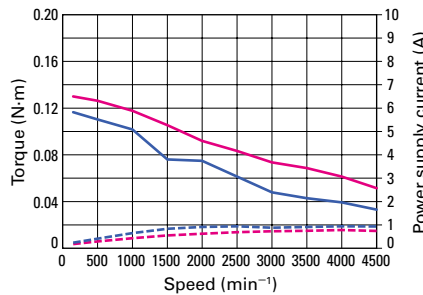

③ Motor model number **PBM423DXK50**

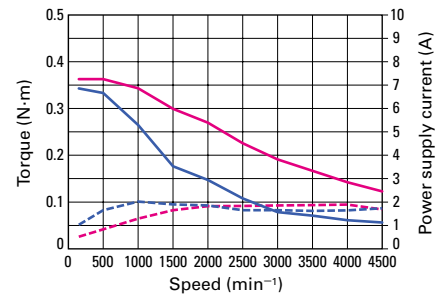

④ Motor model number **PBM603DXK50**

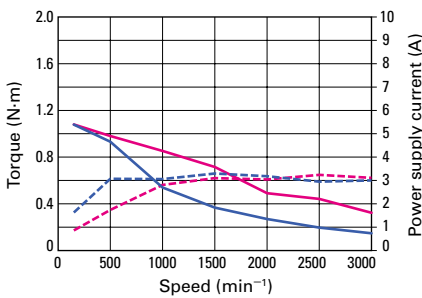

⑤ Motor model number **PBM604DXK50**

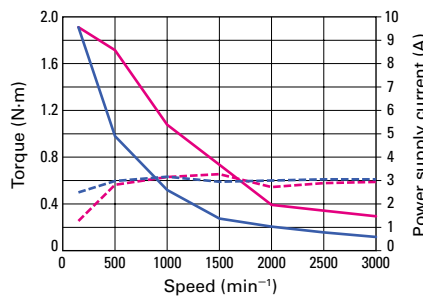

Low-backlash gear model Optical incremental encoder type

RoHS

Size	Motor size	42 mm sq.				
	Motor + gear length	86.1 mm				
Motor model number		PBM423DGAk50	PBM423DGBk50	PBM423DGEk50	PBM423DGGk50	PBM423DGJK50
Compatible driver model number		PB4D003E440	PB4D003E440	PB4D003E440	PB4D003E440	PB4D003E440
Allowable torque	N·m	0.343	0.686	0.98	1.47	1.47
Rotor inertia	$\times 10^{-4}$ kg·m ²	0.056	0.056	0.056	0.056	0.056
Gear ratio	—	1:3.6	1:7.2	1:10	1:20	1:30
Backlash	deg. or less	0.6	0.4	0.35	0.25	0.25
Allowable speed	min ⁻¹	500	250	180	90	60
Rotation direction	Relative to command direction	Forward	Forward	Forward	Reverse	Reverse
Allowable thrust load	N	15	15	15	15	15
Allowable radial load *	N	20	20	20	20	20
Motor mass	kg	0.48	0.48	0.48	0.48	0.48
Characteristics diagram		①	②	③	④	⑤

● Maintain motor surface temperature at 85°C or lower while in use.
 * When load is applied at 1/3 length from output shaft end.

Characteristics diagram

Allowable torque 24 VDC — 48 VDC — 24 VDC/48 VDC — Power supply current 24 VDC 48 VDC

① Motor model number **PBM423DGAk50**

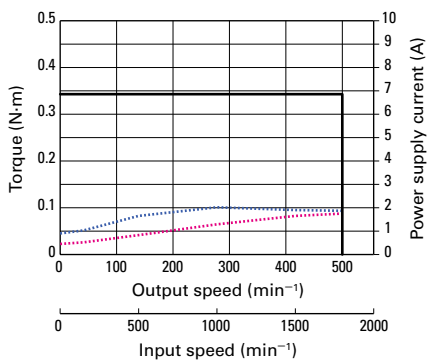

② Motor model number **PBM423DGBk50**

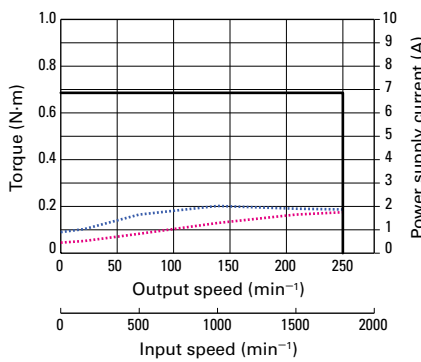

③ Motor model number **PBM423DGEk50**

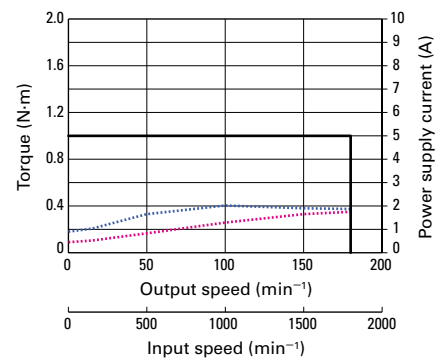

④ Motor model number **PBM423DGGk50**

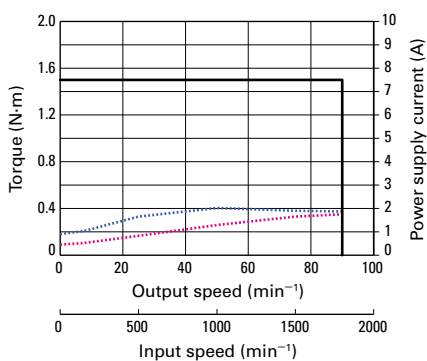

⑤ Motor model number **PBM423DGJK50**

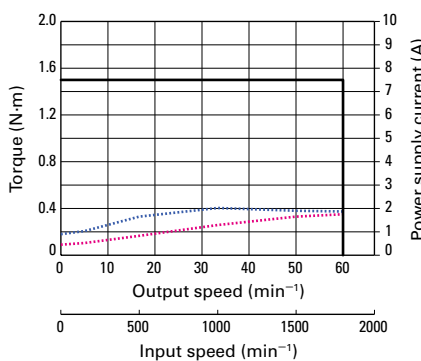

System Configuration Diagram ▶ p. 62 Compatible Driver / Motor Combinations ▶ p. 63 Driver Dimensions ▶ p. 64 Motor Dimensions ▶ pp. 79 to 81

When using a motor with low-backlash gear, exceeding the allowable torque might damage the gear. Carefully select products so that the configured system can operate within the specified limit value.

● Data for the above characteristics is based on SANYO DENKI's internal measurement conditions. Depending on conditions such as machine precision, driving torque may vary as well.

Size	Motor size	60 mm sq.				
	Motor + gear length	114.3 mm				
Motor model number		PBM603DGAK50	PBM603DGBK50	PBM603DGEK50	PBM603DGGK50	PBM603DGJK50
Compatible driver model number		PB4D003E440	PB4D003E440	PB4D003E440	PB4D003E440	PB4D003E440
Allowable torque	N·m	1.25	2.5	3	3.5	4
Rotor inertia	$\times 10^{-4} \text{kg}\cdot\text{m}^2$	0.4	0.4	0.4	0.4	0.4
Gear ratio	—	1:3.6	1:7.2	1:10	1:20	1:30
Backlash	deg. or less	0.55	0.25	0.25	0.17	0.17
Allowable speed	min^{-1}	500	250	180	90	60
Rotation direction	Relative to command direction	Forward	Forward	Reverse	Reverse	Reverse
Allowable thrust load	N	30	30	30	30	30
Allowable radial load *	N	100	100	100	100	100
Motor mass	kg	1.22	1.22	1.22	1.22	1.22
Characteristics diagram		①	②	③	④	⑤

● Maintain motor surface temperature at 85°C or lower while in use.
 * When load is applied at 1/3 length from output shaft end.

Characteristics diagram

Allowable torque 24 VDC — 48 VDC — 24 VDC/48 VDC — Power supply current 24 VDC 48 VDC

① Motor model number **PBM603DGAK50**

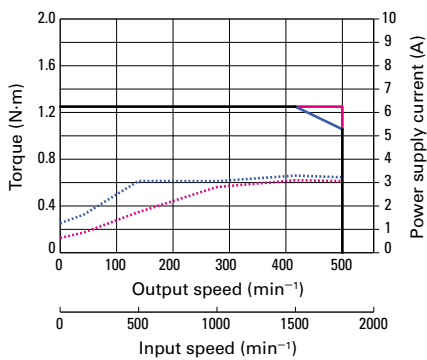

② Motor model number **PBM603DGBK50**

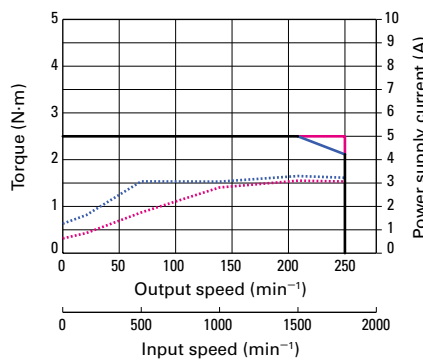

③ Motor model number **PBM603DGEK50**

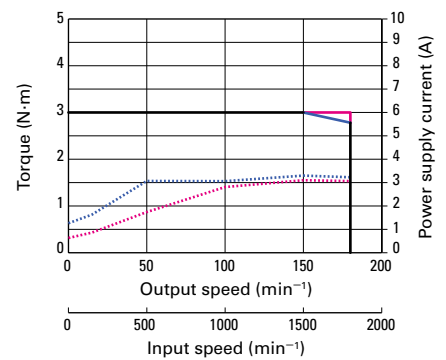

④ Motor model number **PBM603DGGK50**

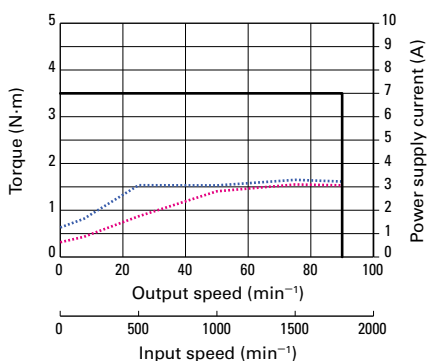

⑤ Motor model number **PBM603DGJK50**

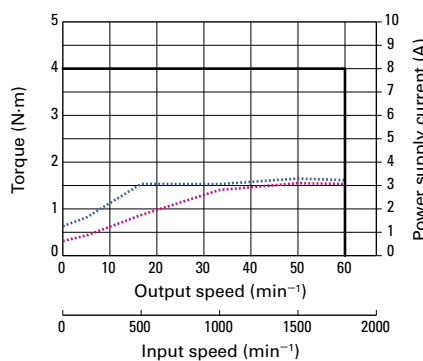

Spur gear model Optical incremental encoder type

RoHS

Size	Motor size	28 mm sq.					
	Motor + gear length	88.6 mm					
Motor model number		PBM281DGAE50	PBM281DGBE50	PBM281DGEE50	PBM281DGGE50	PBM281DGJE50	PBM281DGLE50
Compatible driver model number		PB4D003E440	PB4D003E440	PB4D003E440	PB4D003E440	PB4D003E440	PB4D003E440
Allowable torque	N·m	0.1	0.15	0.2	0.35	0.5	0.5
Rotor inertia	$\times 10^{-4}$ kg·m ²	0.01	0.01	0.01	0.01	0.01	0.01
Gear ratio	—	1:3.6	1:7.2	1:10	1:20	1:30	1:50
Backlash	deg. or less	2	2	2	1.5	1.5	1.5
Allowable speed	min ⁻¹	800	400	300	150	100	60
Rotation direction	Relative to command direction	Forward	Forward	Reverse	Forward	Forward	Forward
Allowable thrust load	N	10	10	10	10	10	10
Allowable radial load *	N	15	15	15	15	15	15
Motor mass	kg	0.22	0.22	0.22	0.22	0.22	0.22
Characteristics diagram		①	②	③	④	⑤	⑥

● Maintain motor surface temperature at 85°C or lower while in use.
 * When load is applied at 1/3 length from output shaft end.

Characteristics diagram

Allowable torque 24VDC/48VDC ——— Power supply current 24VDC 48VDC

① Motor model number **PBM281DGAE50**

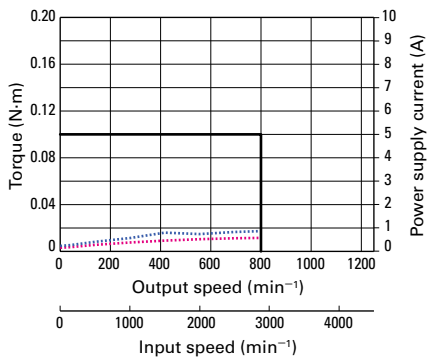

② Motor model number **PBM281DGBE50**

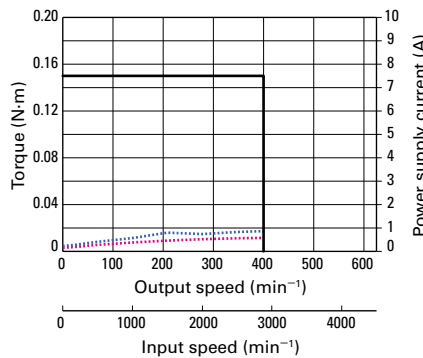

③ Motor model number **PBM281DGEE50**

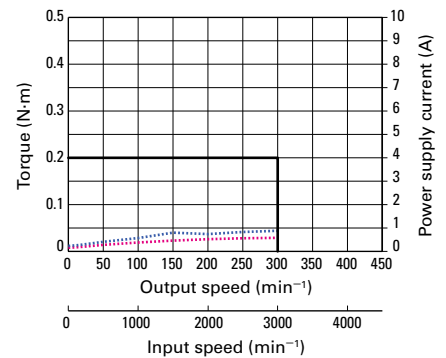

④ Motor model number **PBM281DGGE50**

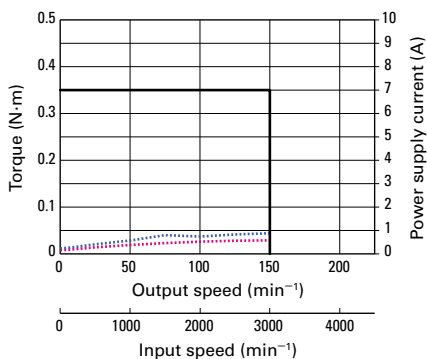

⑤ Motor model number **PBM281DGJE50**

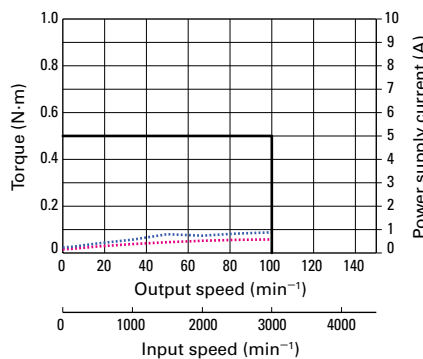

⑥ Motor model number **PBM281DGLE50**

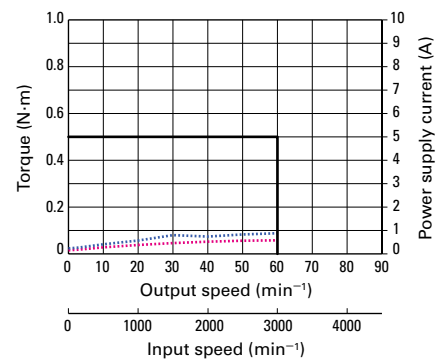

System Configuration Diagram ▶ p. 62 Compatible Driver / Motor Combinations ▶ p. 63 Driver Dimensions ▶ p. 64 Motor Dimensions ▶ pp. 79 to 81

When using a motor with spur gear, exceeding the allowable torque might damage the gear. Carefully select products so that the configured system can operate within the specified limit value.

● Data for the above characteristics is based on SANYO DENKI's internal measurement conditions. Depending on conditions such as machine precision, driving torque may vary as well.

Size	Motor size	28 mm sq. (angular dimension 33 mm sq.)		42 mm sq.		
	Motor + gear length	97.7 mm		95.1 mm		
Motor model number		PBM281DHLE50	PBM281DHME50	PBM423DHJK50	PBM423DHLK50	PBM423DHMK50
Compatible driver model number		PB4D003E440	PB4D003E440	PB4D003E440	PB4D003E440	PB4D003E440
Allowable torque	N·m	1.5	2	2.2	3.5	5
Allowable instantaneous torque	N·m	2.6	3.6	4.5	8.3	11
Rotor inertia	×10 ⁻⁴ kg·m ²	0.013	0.013	0.068	0.068	0.068
Gear ratio	—	1:50	1:100	1:30	1:50	1:100
Hysteresis loss	Arc min or less	—	—	3.6	2.4	2.4
Lost motion	Arc min	0.4 to 3 (at ±0.06 N·m)	0.4 to 3 (at ±0.08 N·m)	—	—	—
Allowable speed	min ⁻¹	70	35	116	70	35
Rotation direction	Relative to command direction	Reverse	Reverse	Reverse	Reverse	Reverse
Allowable thrust load	N	100	100	1150	1150	1150
Allowable radial load *	N	160	160	275	275	275
Motor mass	kg	0.27	0.27	0.54	0.54	0.54
Characteristics diagram		①	②	③	④	⑤

● Maintain motor surface temperature at 85°C or lower while in use.
* When load is applied at 1/3 length from output shaft end.

Characteristics diagram

Allowable torque 24 VDC — 48 VDC — 24 VDC/48 VDC —
 Allowable instantaneous torque 24 VDC - - - 48 VDC - - - 24 VDC/48 VDC - - -
 Power supply current 24 VDC 48 VDC

① Motor model number **PBM281DHLE50**

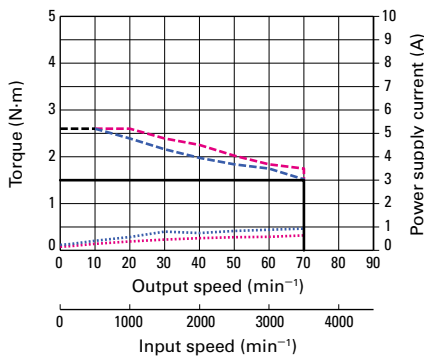

② Motor model number **PBM281DHME50**

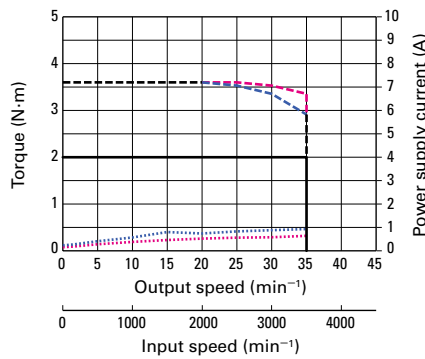

③ Motor model number **PBM423DHJK50**

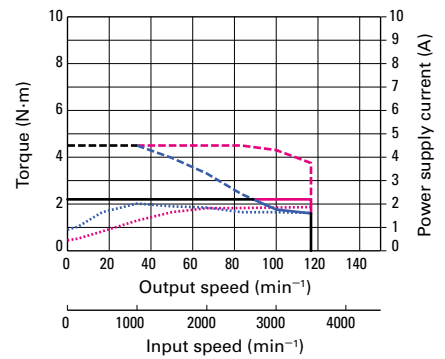

④ Motor model number **PBM423DHLK50**

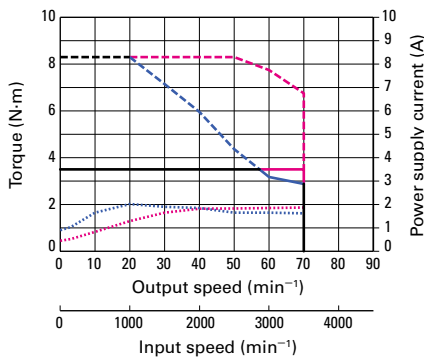

⑤ Motor model number **PBM423DHMK50**

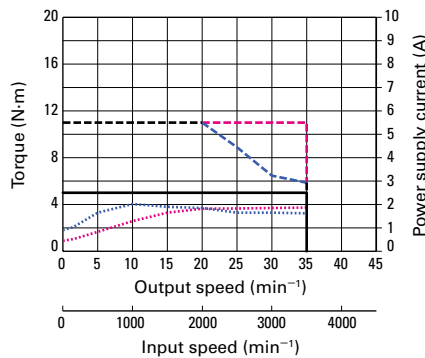

System Configuration Diagram ▶ p. 62 Compatible Driver / Motor Combinations ▶ p. 63 Driver Dimensions ▶ p. 64 Motor Dimensions ▶ pp. 79 to 81

When using a motor with harmonic gear, exceeding the allowable instantaneous torque might damage the gear. Carefully select products so that the configured system can operate within the specified limit value.

● Data for the above characteristics is based on SANYO DENKI's internal measurement conditions. Depending on conditions such as machine precision, driving torque may vary as well.

Harmonic gear model Optical incremental encoder type

RoHS

Size	Motor size	60 mm sq.	
	Motor + gear length	135.8 mm	
Motor model number		PBM603DHLK50	PBM603DHMK50
Compatible driver model number		PB4D003E440	PB4D003E440
Allowable torque	N·m	5.5	8
Allowable instantaneous torque	N·m	14	20
Rotor inertia	$\times 10^{-4} \text{kg}\cdot\text{m}^2$	0.435	0.435
Gear ratio	—	1:50	1:100
Hysteresis loss	Arc min or less	—	—
Lost motion	Arc min	0.4 to 3 (at $\pm 0.28 \text{ N}\cdot\text{m}$)	0.4 to 1.5 (at $\pm 0.4 \text{ N}\cdot\text{m}$)
Allowable speed	min^{-1}	70	35
Rotation direction	Relative to command direction	Reverse	Reverse
Allowable thrust load	N	400	400
Allowable radial load *	N	360	360
Motor mass	kg	1.45	1.45
Characteristics diagram		①	②

● Maintain motor surface temperature at 85°C or lower while in use.
* When load is applied at 1/3 length from output shaft end.

Characteristics diagram

Allowable torque 24 VDC — 48 VDC — 24 VDC/48 VDC —
 Allowable instantaneous torque 24 VDC - - - 48 VDC - - - 24 VDC/48 VDC - - - Power supply current 24 VDC 48 VDC

① Motor model number **PBM603DHLK50**

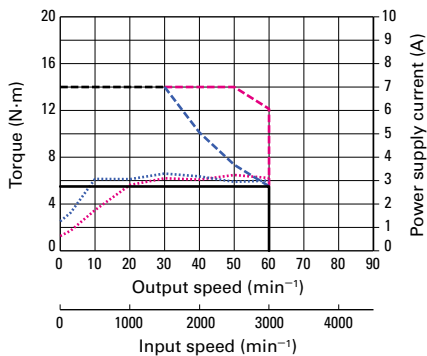

② Motor model number **PBM603DHMK50**

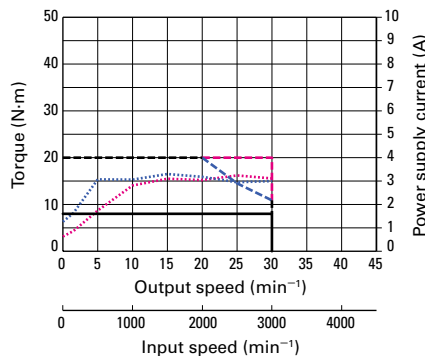

System Configuration Diagram ▶ p. 62 Compatible Driver / Motor Combinations ▶ p. 63 Driver Dimensions ▶ p. 64 Motor Dimensions ▶ pp. 79 to 81

When using a motor with harmonic gear, exceeding the allowable instantaneous torque might damage the gear. Carefully select products so that the configured system can operate within the specified limit value.

● Data for the above characteristics is based on SANYO DENKI's internal measurement conditions. Depending on conditions such as machine precision, driving torque may vary as well.

Size	Motor size		28 mm sq.		42 mm sq.	60 mm sq.		
	Motor + brake length		98.5 mm	117.8 mm	88.3 mm	108.1 mm	140.1 mm	
Motor model number			PBM281DCE50	PBM285DCE50	PBM423DCK50	PBM603DCK50	PBM604DCK50	
Compatible driver model number			PB4D003E440	PB4D003E440	PB4D003E440	PB4D003E440	PB4D003E440	
Max. stall torque		N·m	0.055	0.115	0.39	1.05	1.85	
Rotor inertia		$\times 10^{-4}$ kg·m ²	0.011	0.023	0.071	0.559	1.0	
Allowable thrust load		N	9.8	9.8	9.8	14.7	14.7	
Allowable radial load *		N	26	26	48	120	120	
Motor mass		kg	0.28	0.35	0.5	1.19	1.76	
Electromagnetic brake	Brake type		No excitation actuating type		No excitation actuating type		No excitation actuating type	
	Power supply voltage		24 VDC \pm 5%		24 VDC \pm 5%		24 VDC \pm 5%	
	Power consumption		3.6 (at 20°C)		2.4 (at 75°C)		6 (at 75°C)	
	Static friction torque		0.049		0.3		0.8	
	Brake operating time		20		20		20	
	Brake release time		20		30		30	
Characteristics diagram			①	②	③	④	⑤	

● Maintain motor surface temperature at 85°C or lower while in use.
* The load point is at the end of the output shaft.

Characteristics diagram

Torque 24 VDC — 48 VDC — Power supply current 24 VDC - - - 48 VDC - - -

① Motor model number **PBM281DCE50**

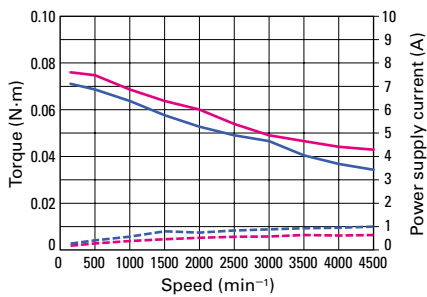

② Motor model number **PBM285DCE50**

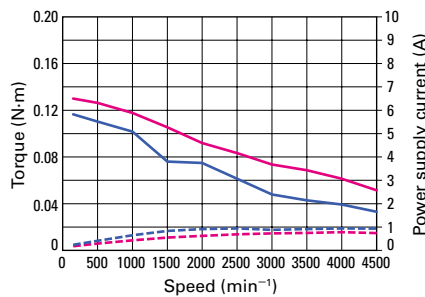

③ Motor model number **PBM423DCK50**

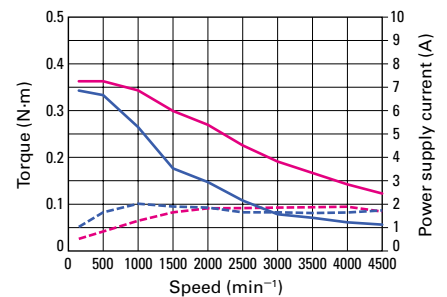

④ Motor model number **PBM603DCK50**

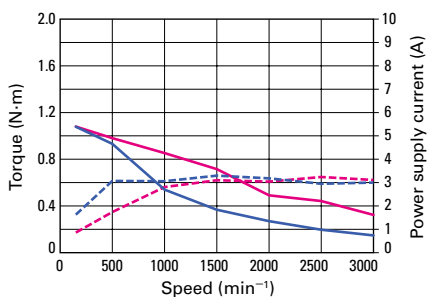

⑤ Motor model number **PBM604DCK50**

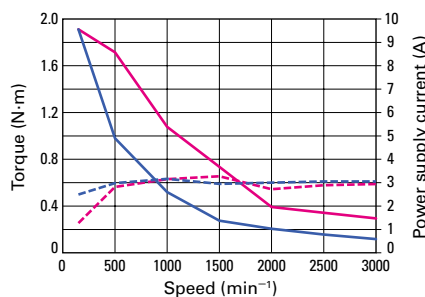

Standard model Battery-less optical absolute encoder type

RoHS

Size	Motor size	42 mm sq.		60 mm sq.	
	Motor length	74.7 mm		87.6 mm	119.6 mm
Motor model number		PBM423DXR50		PBM603DXR50	PBM604DXR50
Compatible driver model number		PB4D003E440		PB4D003E440	PB4D003E440
Max. stall torque	N·m	0.39		1.05	1.85
Rotor inertia	$\times 10^{-4}$ kg·m ²	0.056		0.4	0.84
Allowable thrust load	N	9.8		14.7	14.7
Allowable radial load *	N	48		120	120
Motor mass	kg	0.42		0.88	1.45
Characteristics diagram		①		②	③

● Maintain motor surface temperature at 85°C or lower while in use.
 * The load point is at the end of the output shaft.

Characteristics diagram

Torque 24VDC — 48VDC — Power supply current 24VDC - - - 48VDC - - -

① Motor model number **PBM423DXR50**

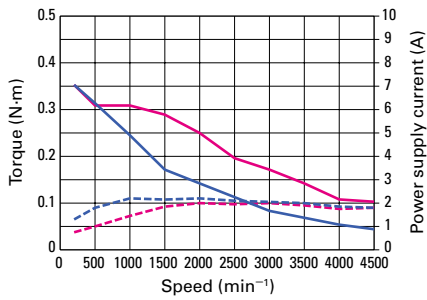

② Motor model number **PBM603DXR50**

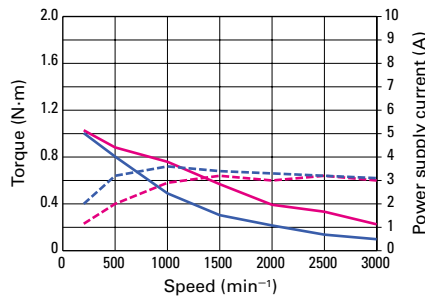

③ Motor model number **PBM604DXR50**

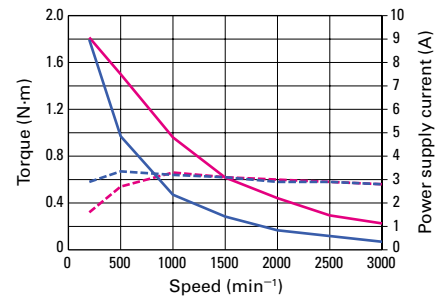

Size	Motor size	42 mm sq.				
	Motor + gear length	104.9 mm				
Motor model number		PBM423DGAR50	PBM423DGBR50	PBM423DGER50	PBM423DGGR50	PBM423DGJR50
Compatible driver model number		PB4D003E440	PB4D003E440	PB4D003E440	PB4D003E440	PB4D003E440
Allowable torque	N·m	0.343	0.686	0.98	1.47	1.47
Rotor inertia	$\times 10^{-4}$ kg·m ²	0.056	0.056	0.056	0.056	0.056
Gear ratio	—	1:3.6	1:7.2	1:10	1:20	1:30
Backlash	deg. or less	0.6	0.4	0.35	0.25	0.25
Allowable speed	min ⁻¹	500	250	180	90	60
Rotation direction	Relative to command direction	Forward	Forward	Forward	Reverse	Reverse
Allowable thrust load	N	15	15	15	15	15
Allowable radial load *	N	20	20	20	20	20
Motor mass	kg	0.54	0.54	0.54	0.54	0.54
Characteristics diagram		①	②	③	④	⑤

● Maintain motor surface temperature at 85°C or lower while in use.
 * When load is applied at 1/3 length from output shaft end.

Characteristics diagram

Allowable torque 24 VDC — 48 VDC — 24 VDC/48 VDC — Power supply current 24 VDC 48 VDC

① Motor model number **PBM423DGAR50**

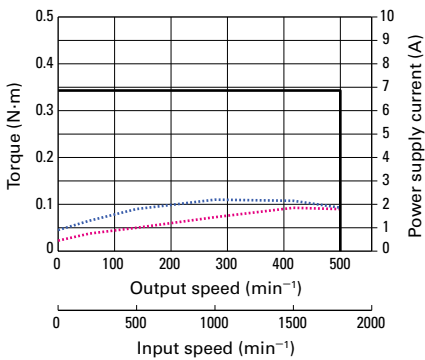

② Motor model number **PBM423DGBR50**

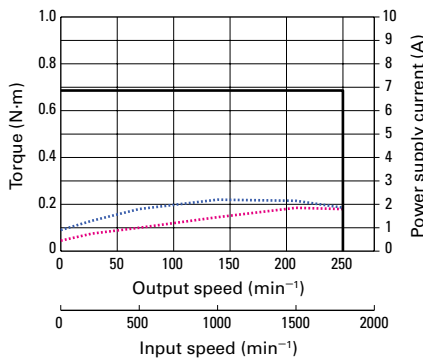

③ Motor model number **PBM423DGER50**

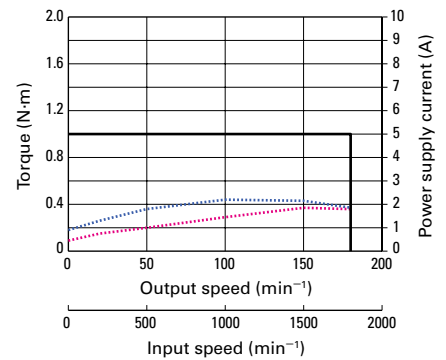

④ Motor model number **PBM423DGGR50**

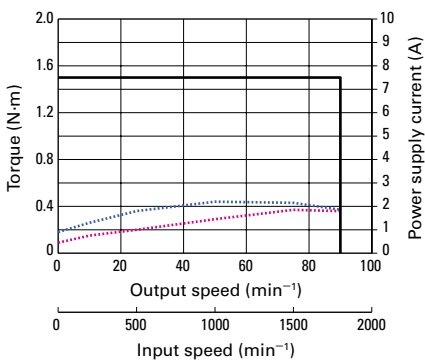

⑤ Motor model number **PBM423DGJR50**

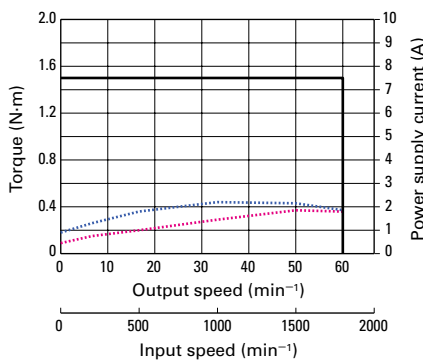

Low-backlash gear model Battery-less optical absolute encoder type

RoHS

Size		60 mm sq.				
		133.1 mm				
Motor size	Motor + gear length					
Motor model number		PBM603DGAR50	PBM603DGBR50	PBM603DGER50	PBM603DGGR50	PBM603DGJR50
Compatible driver model number		PB4D003E440	PB4D003E440	PB4D003E440	PB4D003E440	PB4D003E440
Allowable torque	N·m	1.25	2.5	3	3.5	4
Rotor inertia	$\times 10^{-4}$ kg·m ²	0.4	0.4	0.4	0.4	0.4
Gear ratio	—	1:3.6	1:7.2	1:10	1:20	1:30
Backlash	deg. or less	0.55	0.25	0.25	0.17	0.17
Allowable speed	min ⁻¹	500	250	180	90	60
Rotation direction	Relative to command direction	Forward	Forward	Reverse	Reverse	Reverse
Allowable thrust load	N	30	30	30	30	30
Allowable radial load *	N	100	100	100	100	100
Motor mass	kg	1.28	1.28	1.28	1.28	1.28
Characteristics diagram		①	②	③	④	⑤

● Maintain motor surface temperature at 85°C or lower while in use.
 * When load is applied at 1/3 length from output shaft end.

Characteristics diagram

Allowable torque 24 VDC — 48 VDC — 24 VDC/48 VDC — Power supply current 24 VDC 48 VDC

① Motor model number **PBM603DGAR50**

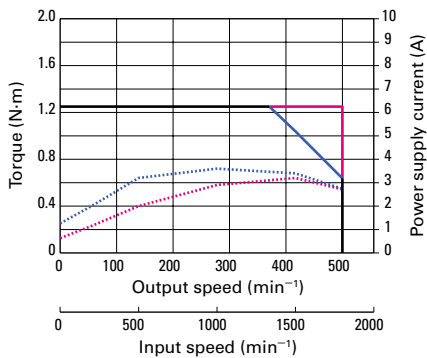

② Motor model number **PBM603DGBR50**

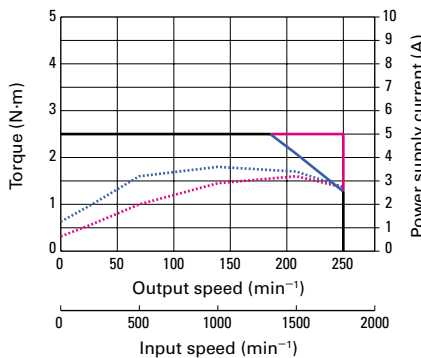

③ Motor model number **PBM603DGER50**

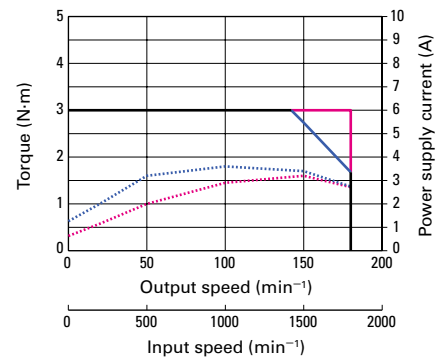

④ Motor model number **PBM603DGGR50**

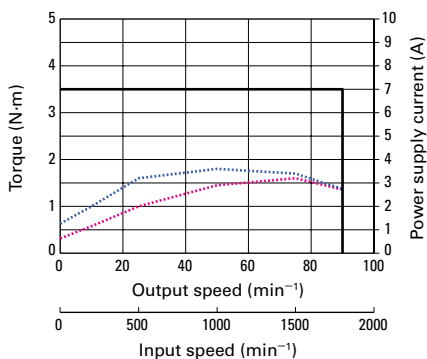

⑤ Motor model number **PBM603DGJR50**

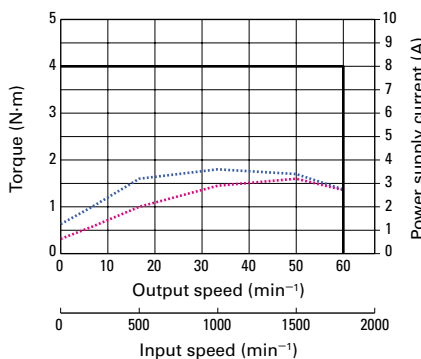

System Configuration Diagram ▶ p. 62 Compatible Driver / Motor Combinations ▶ p. 63 Driver Dimensions ▶ p. 64 Motor Dimensions ▶ pp. 82 to 83

When using a motor with low-backlash gear, exceeding the allowable torque might damage the gear. Carefully select products so that the configured system can operate within the specified limit value.

● Data for the above characteristics is based on SANYO DENKI's internal measurement conditions. Depending on conditions such as machine precision, driving torque may vary as well.

Size	Motor size	42 mm sq.			60 mm sq.	
	Motor + gear length	113.9 mm			154.6 mm	
Motor model number		PBM423DHJR50	PBM423DHLR50	PBM423DHMR50	PBM603DHLR50	PBM603DHMR50
Compatible driver model number		PB4D003E440	PB4D003E440	PB4D003E440	PB4D003E440	PB4D003E440
Allowable torque	N·m	2.2	3.5	5	5.5	8
Allowable instantaneous torque	N·m	4.5	8.3	11	14	20
Rotor inertia	$\times 10^{-4}$ kg·m ²	0.068	0.068	0.068	0.435	0.435
Gear ratio	—	1:30	1:50	1:100	1:50	1:100
Hysteresis loss	Arc min or less	3.6	2.4	2.4	—	—
Lost motion	Arc min	—	—	—	0.4 to 3 (at ± 0.28 N·m)	0.4 to 1.5 (at ± 0.4 N·m)
Allowable speed	min ⁻¹	116	70	35	70	35
Rotation direction	Relative to command direction	Reverse	Reverse	Reverse	Reverse	Reverse
Allowable thrust load	N	1150	1150	1150	400	400
Allowable radial load *	N	209	209	209	360	360
Motor mass	kg	0.6	0.6	0.6	1.5	1.5
Characteristics diagram		①	②	③	④	⑤

● Maintain motor surface temperature at 85°C or lower while in use.
* When load is applied at 1/3 length from output shaft end.

Characteristics diagram

Allowable torque 24 VDC — 48 VDC — 24 VDC/48 VDC —
 Allowable instantaneous torque 24 VDC - - - 48 VDC - - - 24 VDC/48 VDC - - -
 Power supply current 24 VDC 48 VDC

① Motor model number **PBM423DHJR50**

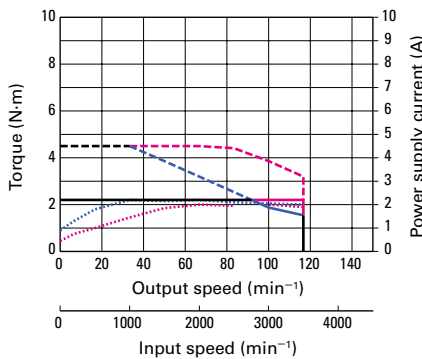

② Motor model number **PBM423DHLR50**

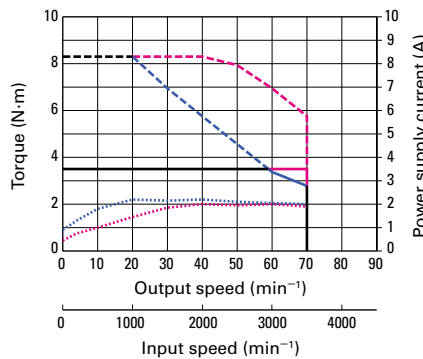

③ Motor model number **PBM423DHMR50**

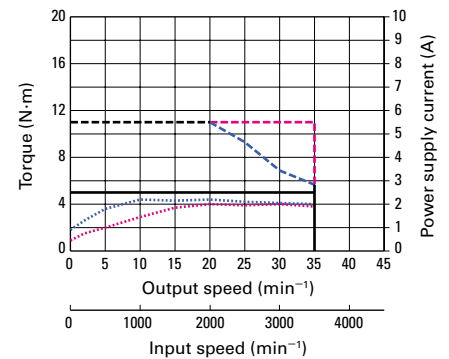

④ Motor model number **PBM603DHLR50**

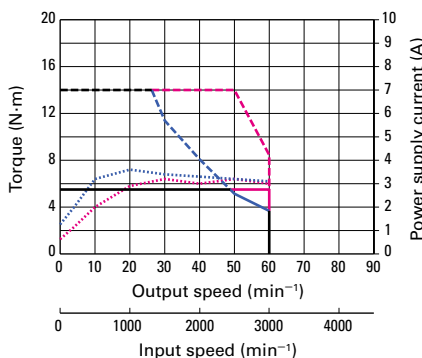

⑤ Motor model number **PBM603DHMR50**

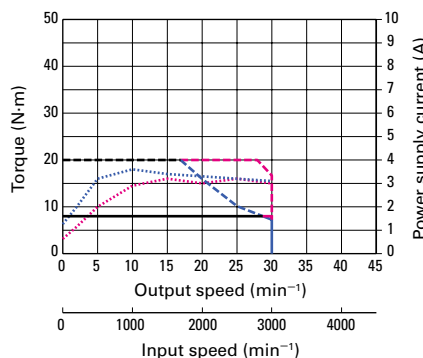

System Configuration Diagram ▶ p. 62 Compatible Driver / Motor Combinations ▶ p. 63 Driver Dimensions ▶ p. 64 Motor Dimensions ▶ pp. 82 to 83

When using a motor with harmonic gear, exceeding the allowable instantaneous torque might damage the gear. Carefully select products so that the configured system can operate within the specified limit value.

● Data for the above characteristics is based on SANYO DENKI's internal measurement conditions. Depending on conditions such as machine precision, driving torque may vary as well.

Electromagnetic brake model

Battery-less optical absolute encoder type

RoHS

Size	Motor size	42 mm sq.		60 mm sq.		
	Motor + brake length	107.4 mm	126.9 mm	158.9 mm		
Motor model number		PBM423DCR50	PBM603DCR50	PBM604DCR50		
Compatible driver model number		PB4D003E440	PB4D003E440	PB4D003E440		
Max. stall torque	N·m	0.39	1.05	1.85		
Rotor inertia	$\times 10^{-4} \text{kg}\cdot\text{m}^2$	0.071	0.559	1		
Allowable thrust load	N	9.8	14.7	14.7		
Allowable radial load *	N	48	120	120		
Motor mass	kg	0.56	1.25	1.82		
Electromagnetic brake	Brake type	—	No excitation actuating type	No excitation actuating type	No excitation actuating type	
	Power supply voltage	V	24 VDC \pm 5%	24 VDC \pm 5%	24 VDC \pm 5%	
	Power consumption	W	2.4 (at 75°C)	6 (at 75°C)	6 (at 75°C)	
	Static friction torque	N·m or over	0.3	0.8	0.8	
	Brake operating time	ms or less	20	20	20	
	Brake release time	ms or less	30	30	30	
Characteristics diagram		①	②	③		

● Maintain motor surface temperature at 85°C or lower while in use.
 * The load point is at the end of the output shaft.

Characteristics diagram

Torque 24VDC — 48VDC — Power supply current 24VDC - - - 48VDC - - -

① Motor model number **PBM423DCR50**

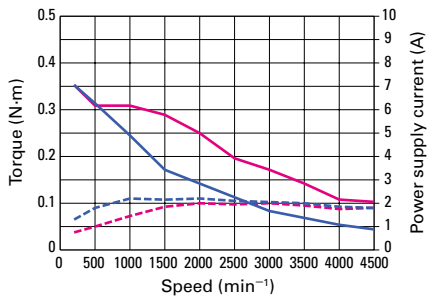

② Motor model number **PBM603DCR50**

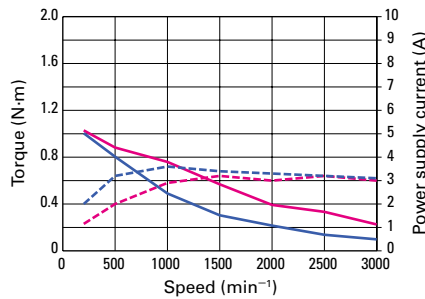

③ Motor model number **PBM604DCR50**

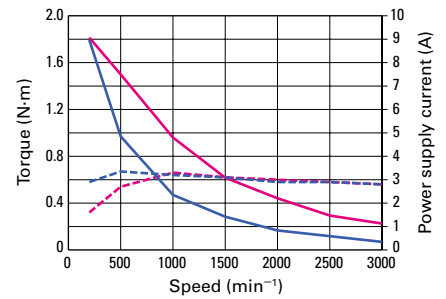

Motor Dimensions

Unit: mm

Optical incremental encoder type

Standard model

28 mm sq.

Motor model number	Motor length (L)
PBM281DXE50	59.2
PBM285DXE50	78.5

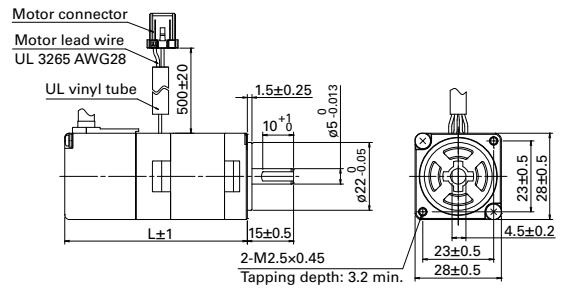
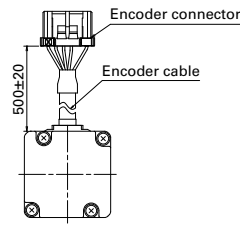

42 mm sq.

Motor model number	Motor length (L)
PBM423DXK50	

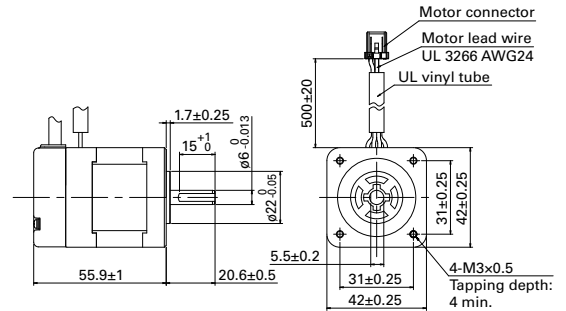
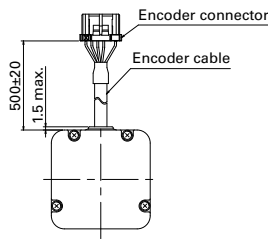

60 mm sq.

Motor model number	Motor length (L)
PBM603DXK50	68.8
PBM604DXK50	100.8

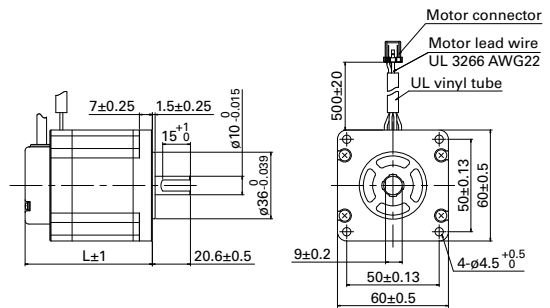
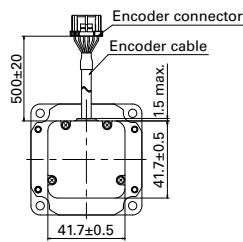

Low-backlash gear model

42 mm sq.

Motor model number	Motor length (L)
PBM423DG□K50	

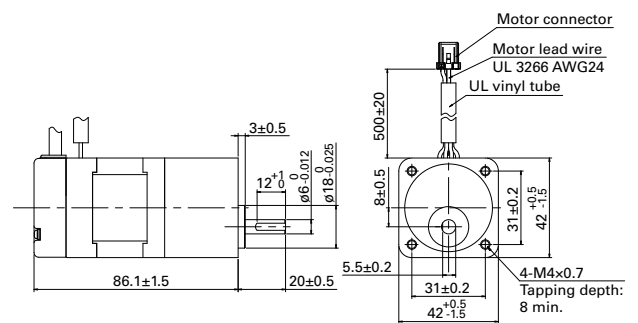
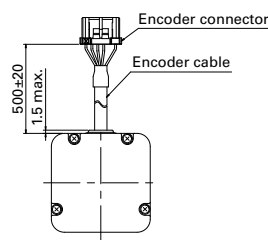

60 mm sq.

Motor model number	Motor length (L)
PBM603DG□K50	

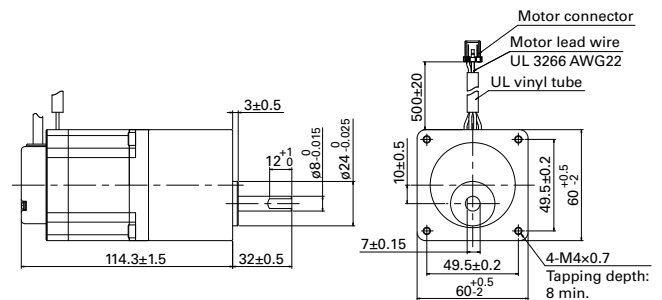
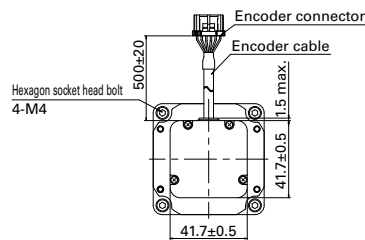

AC Input Set Models
Type R

AC Input Set Models
Type P

DC Input Set Models
Type M

DC Input Drivers / Motors
Type P Multi-axis

DC Input Drivers / Motors
Type E Multi-axis EtherCAT interface

Options

Motor Dimensions

Unit: mm

Optical incremental encoder type

Spur gear model

28 mm sq.

Motor model number
PBM281DG□E50

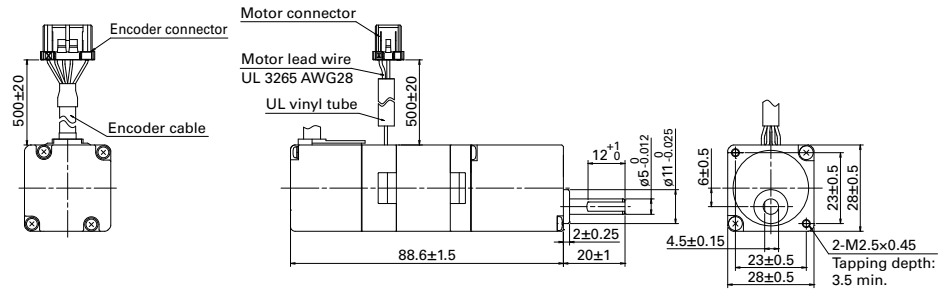

Harmonic gear model

28 mm sq.

Motor model number
PBM281DH□E50

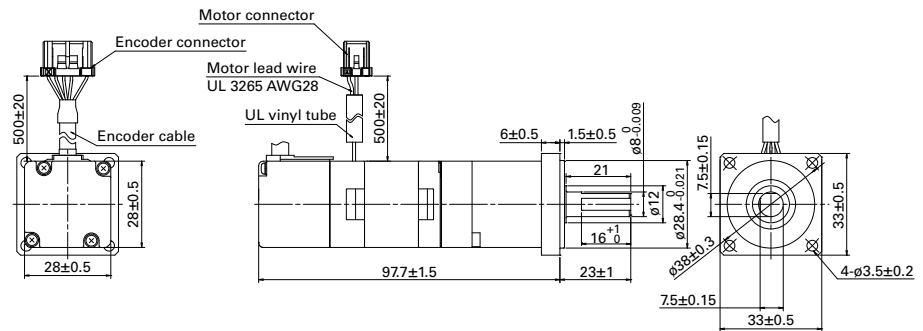

42 mm sq.

Motor model number
PBM423DH□K50

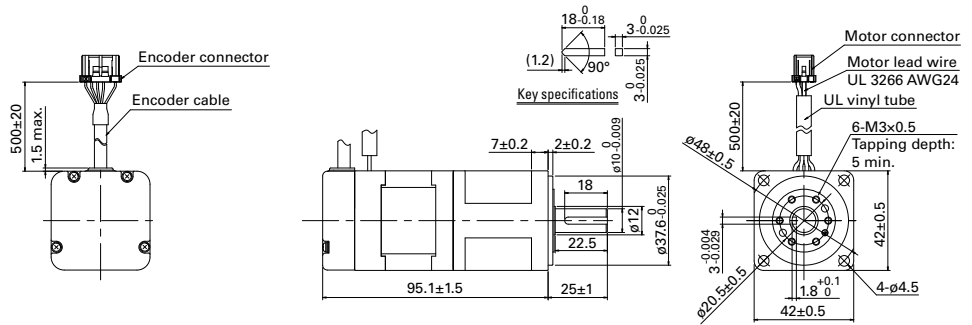

60 mm sq.

Motor model number
PBM603DH□K50

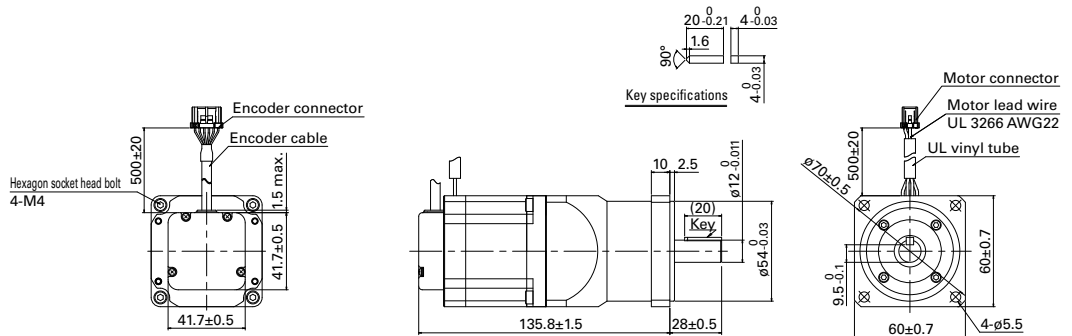

Electromagnetic brake model

28 mm sq.

Motor model number	Motor length (L)
PBM281DCE50	98.5
PBM285DCE50	117.8

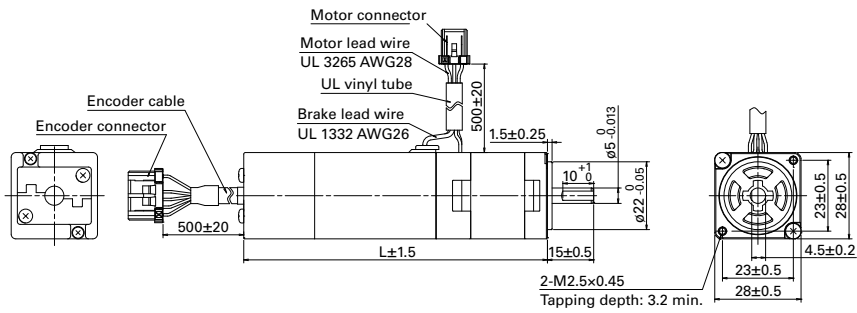

42 mm sq.

Motor model number
PBM423DCK50

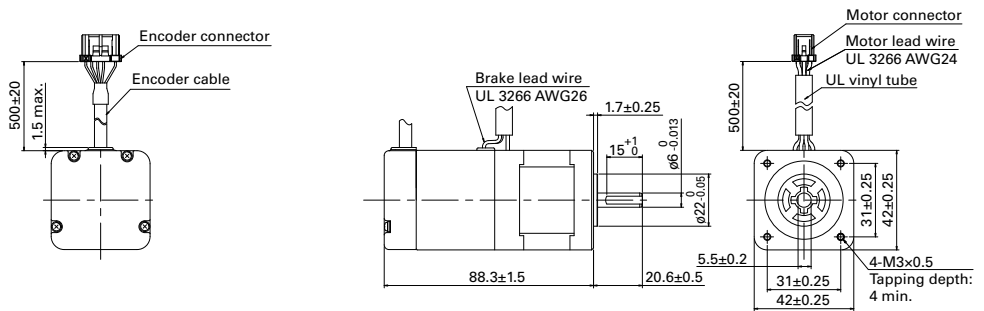

60 mm sq.

Motor model number	Motor length (L)
PBM603DCK50	108.1
PBM604DCK50	140.1

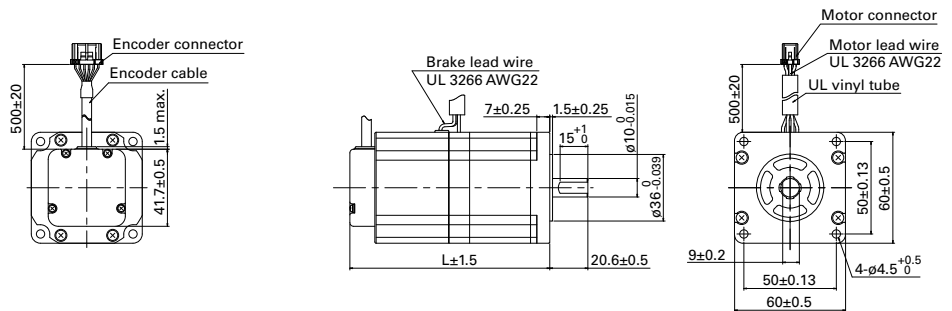

Connector specifications

Encoder connector

Housing: 1-1827864-6
Terminal: 1827569-2
Manufacturer: Tyco Electronics Japan G.K.

Connections of encoder side connectors

Pin no.	Lead wire color	Signal name
A1	Blue	CHANNEL A
B1	Brown	CHANNEL \bar{A}
A2	Green	CHANNEL B
B2	Purple	CHANNEL \bar{B}
A3	White	CHANNEL Z
B3	Yellow	CHANNEL \bar{Z}
A4	Red	+5V
B4	Black	0V
A5	N.C.	—
B5	N.C.	—
A6	Black	Shielded
B6	N.C.	—

Encoder cable: UL 20276

Motor connector

Housing: 2-1827864-3
Terminal: 1827569-2 for 28 mm sq., 1827570-2 for 42/60 mm sq.
Manufacturer: Tyco Electronics Japan G.K.

Connections of motor side connectors

Standard model, Low-backlash gear model, Spur gear model, Harmonic gear model

Pin no.	Lead wire color	Signal name
A1	Blue	Motor lead wire
B1	Orange	Motor lead wire
A2	Red	Motor lead wire
B2	Yellow	Motor lead wire
A3	N.C.	—
B3	N.C.	—

Electromagnetic brake model

Pin no.	Lead wire color	Signal name
A1	Blue	Motor lead wire
B1	Orange	Motor lead wire
A2	Red	Motor lead wire
B2	Yellow	Motor lead wire
A3	28 mm sq.: Brown 42 mm sq.: Brown 60 mm sq.: White	Brake lead wire Polarity: +
B3	28 mm sq.: Brown 42 mm sq.: White 60 mm sq.: Black	Brake lead wire Polarity: -

Motor Dimensions

Unit: mm

Battery-less optical absolute encoder type

Standard model

42 mm sq.

Motor model number	
PBM423DXR50	

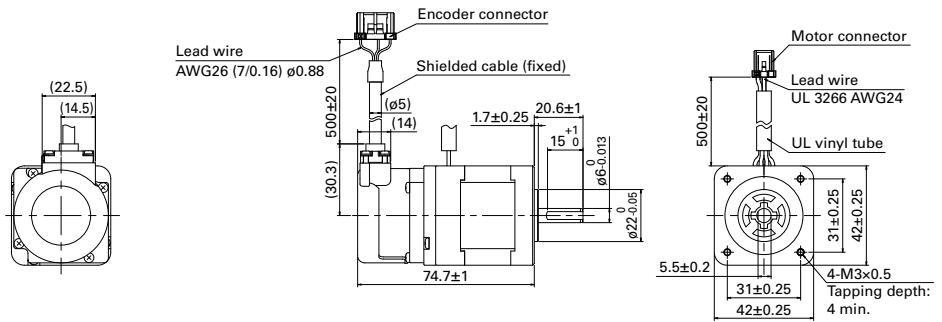

60 mm sq.

Motor model number	Motor length (L)
PBM603DXR50	87.6
PBM604DXR50	119.6

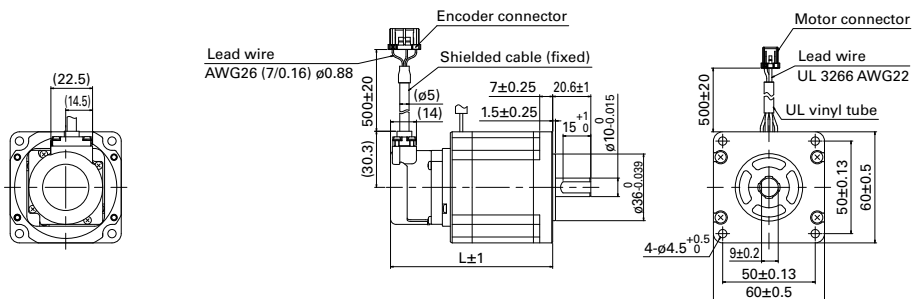

Low-backlash gear model

42 mm sq.

Motor model number	
PBM423DG□R50	

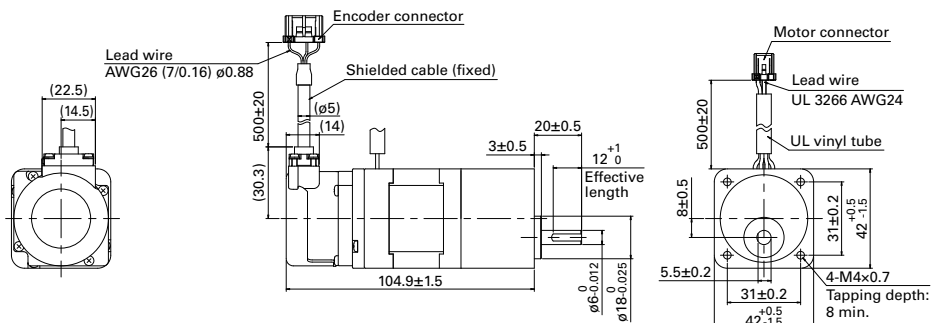

60 mm sq.

Motor model number	
PBM603DG□R50	

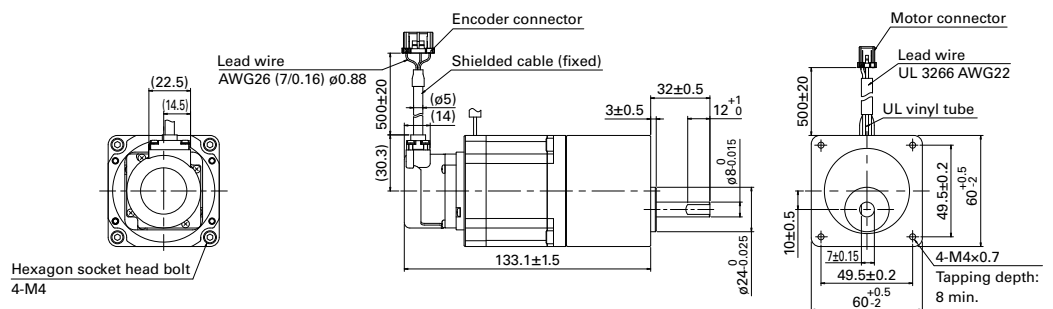

Harmonic gear model

42 mm sq.

Motor model number	
PBM423DH□R50	

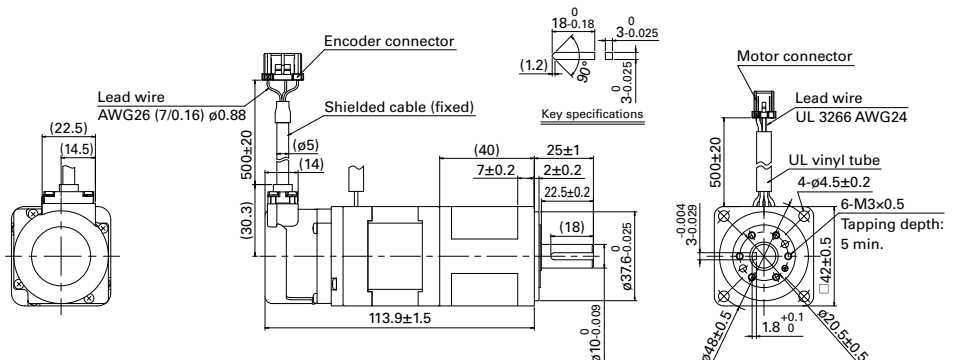

Harmonic gear model

60 mm sq.

Motor model number
PBM603DH□R50

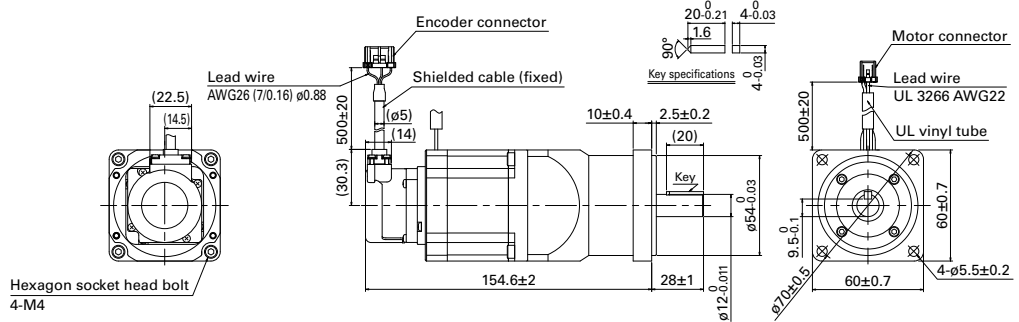

Electromagnetic brake model

42 mm sq.

Motor model number
PBM423DCR50

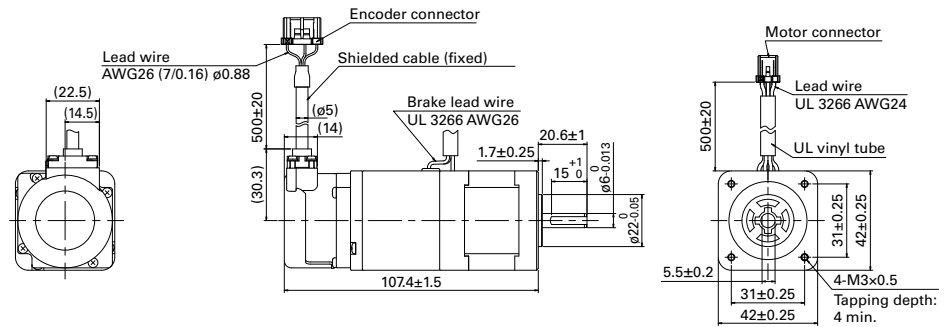

60 mm sq.

Motor model number	Motor length (L)
PBM603DCR50	126.9
PBM604DCR50	158.9

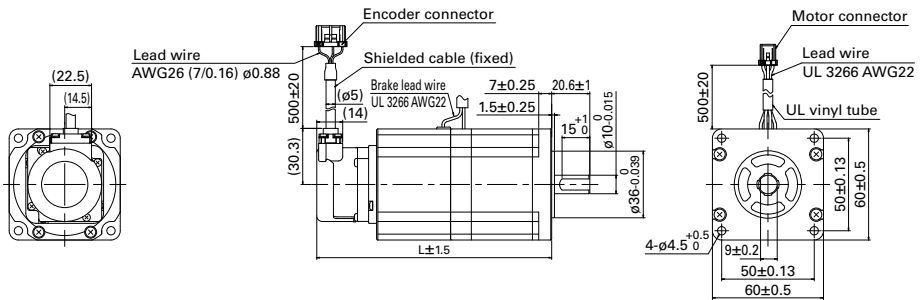

Connector specifications

Encoder connector

Housing: 1-1827864-6
Terminal: 1827570-2
Manufacturer: Tyco Electronics Japan G.K.

Motor connector

Housing: 2-1827864-3
Terminal: 1827570-2
Manufacturer: Tyco Electronics Japan G.K.

Connections of encoder side connectors

Pin no.	Lead wire color	Signal name
A1	Brown	ES+
B1	Blue	ES-
A2	N.C.	—
B2	N.C.	—
A3	N.C.	—
B3	N.C.	—
A4	Red	+5V
B4	Black	0V
A5	N.C.	—
B5	N.C.	—
A6	White / Black	Shielded
B6	N.C.	—

Connections of motor side connectors

Standard model, Low-backlash gear model, Harmonic gear model

Pin no.	Lead wire color	Signal name
A1	Blue	Motor lead wire
B1	Orange	Motor lead wire
A2	Red	Motor lead wire
B2	Yellow	Motor lead wire
A3	N.C.	—
B3	N.C.	—

Electromagnetic brake model

Pin no.	Lead wire color	Signal name
A1	Blue	Motor lead wire
B1	Orange	Motor lead wire
A2	Red	Motor lead wire
B2	Yellow	Motor lead wire
A3	42 mm sq.: Brown 60 mm sq.: White	Brake lead wire Polarity: +
B3	42 mm sq.: White 60 mm sq.: Black	Brake lead wire Polarity: -

Motor Specifications

General specifications

Motor model number	PBM28□D□E	PBM423D□K	PBM423D□R	PBM60□D□K	PBM60□D□R	
Type	S1 (continuous operation)					
Operating ambient temperature	-10 to +40°C (0 to +40°C for harmonic gear model)					
Storage ambient temperature	-20 to +65°C					
Operating ambient humidity	20 to 90% RH					
Storage ambient humidity	5 to 95% RH					
Operation altitude	1000 m or less above sea level					
Vibration resistance	Tested with frequency 10 to 500 Hz, total amplitude 1.52 mm (10 to 70 Hz), acceleration 150 m/s ² (70 to 500 Hz), sweep time 15 min/cycle, 12 sweeps in each X, Y and Z direction.					
Impact resistance	Tested with 500 m/s ² of acceleration for 11 ms with half-sine wave applying three times for X, Y and Z axes each, 18 times in total.					
Thermal class	B (+130°C)					
Dielectric strength	At normal temperature and humidity, no failure with 500 VAC at 50/60 Hz applied for one minute between motor winding and frame.		At normal temperature and humidity, no failure with 1500 VAC at 50/60 Hz applied for one minute between motor winding and frame.			
	At normal temperature and humidity, not less than 100 MΩ when measured with a 500 VDC megohmmeter between motor winding and frame.					
Insulation resistance	At normal temperature and humidity, not less than 100 MΩ when measured with a 500 VDC megohmmeter between motor winding and frame.					
Protection grade	IP30	IP40				
Thrust play *	0.075 mm max. (load: 1.5 N)					
Radial play **	0.025 mm max. (load: 5 N)					
Shaft runout	0.025 mm					
Concentricity of mounting pilot relative to shaft	ø0.075 mm					
Perpendicularity of mounting surface relative to shaft	0.1 mm					
Motor mounting orientation	Can be freely mounted vertically or horizontally					
Encoder	Specification	Optical incremental	Optical incremental	Battery-less optical absolute	Optical incremental	Battery-less optical absolute
	Resolution	500×4=2000 P/R	4000×4=16000 P/R	17 bit (131,072 P/R)	4000×4=16000 P/R	17 bit (131,072 P/R)
	Number of channels	3 CH ***		—	3 CH ***	—
	Output method	Line driver	Line driver (C-MOS)	—	Line driver (C-MOS)	—
	Max. response frequency	37.5 kHz	300 kHz	—	300 kHz	—
	Power supply voltage	5 VDC ±5%		5 VDC ±10%	5 VDC ±5%	5 VDC ±10%
	Current consumption	140 mA max.	100 mA max.	—	100 mA max.	—

● The user should not test the insulation resistance or insulation withstand voltage because capacitors are inserted into the encoder output ground line and the frame line to prevent noise.

● Take radiation and drive conditions into consideration to maintain motor surface temperature at 85°C or lower while in use.

* Thrust play: Displacement in shaft position in the axial direction when a load is applied to the motor shaft in the axial direction.

** Radial play: Displacement in shaft position in the radial direction when a load is applied in the vertical direction to the mounting surface of shaft at point 1/3 the shaft length from the end of the motor shaft.

*** The Z channel outputs 51 pulses. It is designed for use with drivers listed in this catalog.

PC interface software

This software allows you to set parameters from a PC for closed loop stepping systems. It facilitates system startup and running tests.

The software can be downloaded from Product Information on our website.

<https://www.sanyodenki.com>

■ Setup software title:

SANMOTION MOTOR SETUP SOFTWARE

Compatible driver: DC Input Type P (Multi-axis), Type E (Multi-axis)

■ Main functions

Parameter settings (settings by group)

Diagnosis (alarm display, warning display, alarm cancellation)

Test run execution (speed JOG, positioning operation, motor home position search, serial encoder clearance)

Operating waveform display

For PC-driver communication, the "Type P" requires an interface converter and the "Type E" requires a USB cable, respectively.

■ Supported OS

Windows® 7 / Windows® 8 / Windows® 10

* See our website for details on supported OS versions.

Main Screen

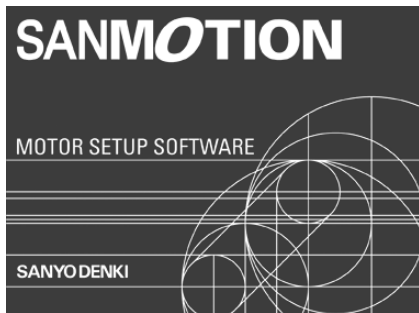

Main Screen

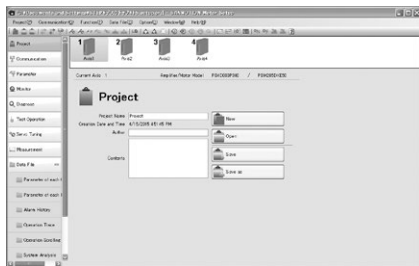

Parameter Setting Screen

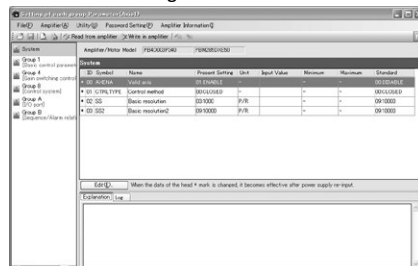

Parameters can be set, saved, and read from a PC.

Alarm Log Screen

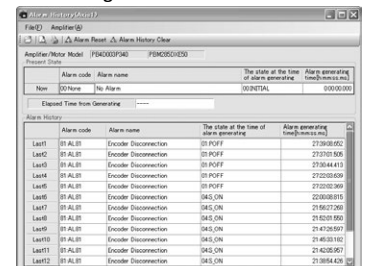

Current and 15 past alarm events can be viewed.

Test run



Motor can be test run easily by inputting speed commands and position commands from a PC. (The screen shows a case of a positioning operation)

Measurement

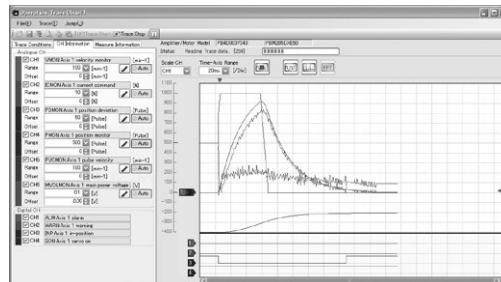

Operation trace
Motor speed, torque, and internal status are displayed in graphics.

PC interface software

■ Setup software title:

SANMOTION Model No. PB Setup software

■ Model no.: SPBALL-01

Compatible driver: AC Input Type P, Type R

■ Model no.: SPBA1W-01

Compatible driver: DC Input Type M

■ Main functions

Direct command capability

Point data editing / execution

Program data editing / execution

Current position / Alarm / Driver status monitoring

Operation waveform tracing, Off-line editing, Teaching function, etc.

For PC-driver communication, an interface converter is required.

■ Supported OS

Windows® Vista / Windows® 7 (runs in Windows XP compatibility mode)

* See our website for details on supported OS versions.

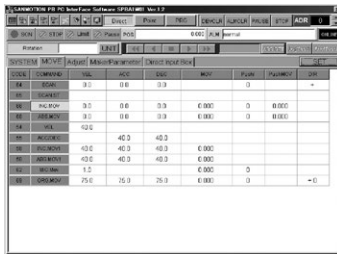

1: Parameter Setting Screen

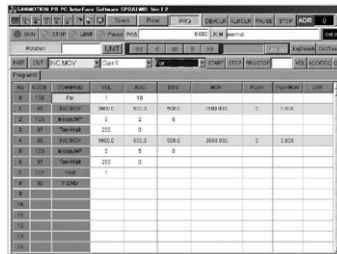

2: Point/Program Input Screen

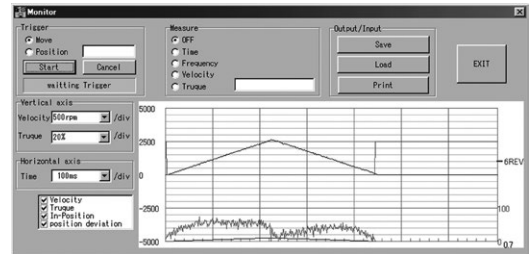

3: Operation Waveform Monitor

(*SPBALL-01 and SPBA1W-01 are supported)

Communications converter unit

■ Model no.: PBFM-U6

Description	Manufacturer model number	Quantity
USB/RS-485 converter	Uport 1130 (manufactured by MOXA)	1
Cable	PBC6T0005A (0.5 m)	1

Refer to the manufacturer's website for instructions on installing the Uport 1130 driver or details on its use.

Options 外形図内単位：mm

■ For AC input (Type R, Type P)

Power cable Model no.: PBC8P0010A

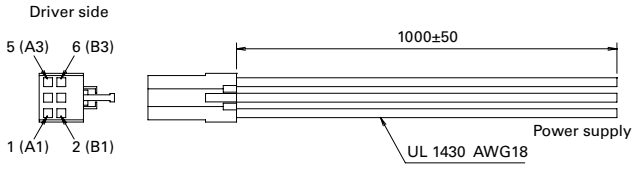

Connector connection

Pin no.	Lead wire color	Signal name
A1	-	-
B1	Black	R
A2	-	-
B2	Black	S
A3	-	-
B3	Black	T

Connector set: PBC8P0000A

Manufacturer model no.	Quantity
Housing: 1-1318119-3	1
Contact: 1318107-1	6

Manufacturer: Tyco Electronics Japan G.K.

Motor extension cable Model no.: PBC7M0030A

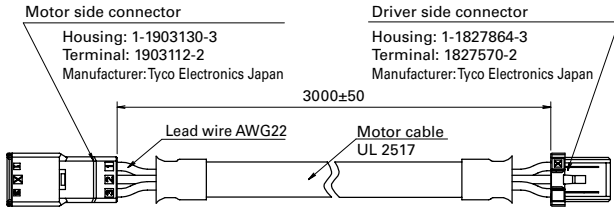

Connections of motor side connectors

Pin no.	Lead wire color	Signal name
A1	Blue	Motor lead wire
B1	Orange	Motor lead wire
A2	Red	Motor lead wire
B2	Yellow	Motor lead wire
A3	White	Brake lead wire
B3	Black	Brake lead wire

Connections of driver side connectors

Pin no.	Lead wire color	Signal name
1 (A1)	Blue	Motor lead wire
2 (B1)	Orange	Motor lead wire
3 (A2)	Red	Motor lead wire
4 (B2)	Yellow	Motor lead wire
5 (A3)	White	Brake lead wire
6 (B3)	Black	Brake lead wire

Connector set: PBC7M0000A

Manufacturer model no.	Quantity
Housing: 1-1903130-3	1
Terminal: 1903112-2	6
Housing: 1-1827864-3	1
Terminal: 1827570-2	6

Manufacturer: Tyco Electronics Japan G.K.

Encoder extension cable Model no.: PBC7E0030A

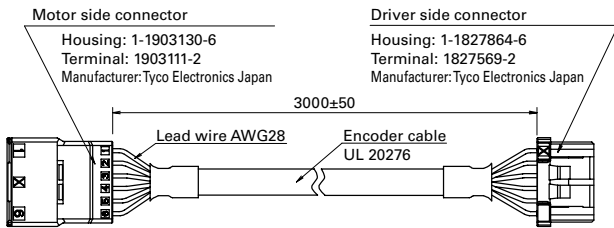

Connections of motor side connectors

Pin no.	Lead wire color	Signal name
A1	Blue	CHANNEL A
B1	Brown	CHANNEL A
A2	Green	CHANNEL B
B2	Purple	CHANNEL B
A3	White	CHANNEL Z
B3	Yellow	CHANNEL Z
A4	Red	+5 V
B4	Black	0 V
A5	N.C.	-
B5	Orange	OVER HEAT
A6	Black	Shield
B6	N.C.	-

Connections of driver side connectors

Pin no.	Lead wire color	Signal name
A1	Blue	CHANNEL A
B1	Brown	CHANNEL A
A2	Green	CHANNEL B
B2	Purple	CHANNEL B
A3	White	CHANNEL Z
B3	Yellow	CHANNEL Z
A4	Red	+5 V
B4	Black	0 V
A5	N.C.	-
B5	Orange	OVER HEAT
A6	Black	Shield
B6	N.C.	-

Connector set: PBC7E0000A

Manufacturer model no.	Quantity
Housing: 1-1903130-6	1
Terminal: 1903111-2	10
Housing: 1-1827864-6	1
Terminal: 1827569-2	10

Manufacturer: Tyco Electronics Japan G.K.

I/O signal cable (unshielded) Model no.: PBC5S0010A (Type R only)

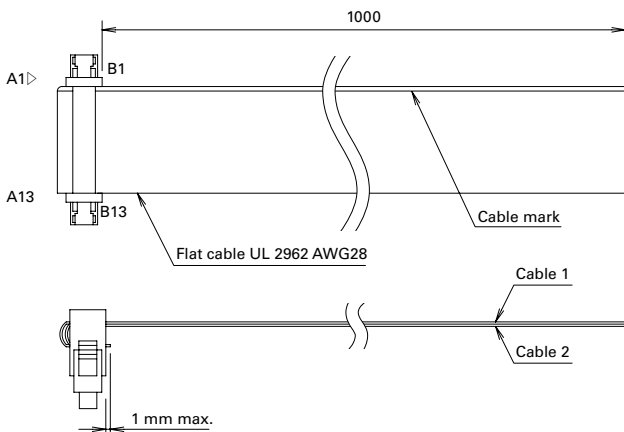

Cable connection

Cable 1	Cable 2
A1-No. 1	B1-No. 14
A2-No. 2	B2-No. 15
A3-No. 3	B3-No. 16
A4-No. 4	B4-No. 17
A5-No. 5	B5-No. 18
A6-No. 6	B6-No. 19
A7-No. 7	B7-No. 20
A8-No. 8	B8-No. 21
A9-No. 9	B9-No. 22
A10-No. 10	B10-No. 23
A11-No. 11	B11-No. 24
A12-No. 12	B12-No. 25
A13-No. 13	B13-No. 26

Connector set: PBC5S0000A

Manufacturer model no.	Quantity
Connector: 8822E-026-171D-F	1

Manufacturer: KEL CORPORATION

Options 外形図内単位：mm

For AC input (Type R, Type P)

I/O signal cable (shielded) Model no.: PBC5S0010C

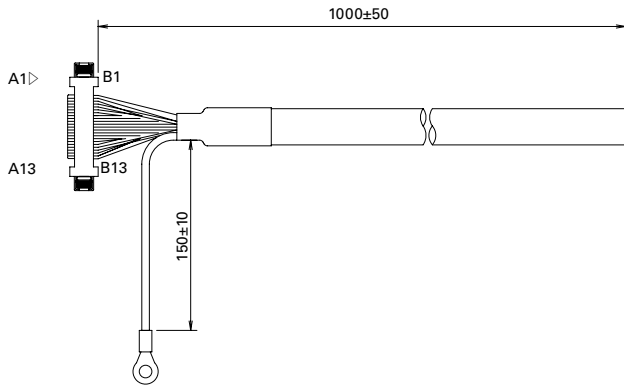

CN wiring

CN1 pin no.	Mark indication	Mark	Wire color
A1		Red	Orange
A2		Black	
A3		Red	
A4		Black	Gray
A5		Red	White
A6		Black	
A7		Red	Yellow
A8		Black	
A9		Red	Pink
A10		Black	
A11		Red	Orange
A12		Black	
A13		Red	Gray

CN1 pin no.	Mark indication	Mark	Wire color
B1		Black	Gray
B2		Red	White
B3		Black	
B4		Red	Yellow
B5		Black	
B6		Red	Pink
B7		Black	
B8		Red	Orange
B9		Black	
B10		Red	Gray
B11		Black	
B12		Red	White
B13		Black	

Connector set: PBC5S0000A

Manufacturer model no.	Quantity
Connector: 8822E-026-171D-F	1
Manufacturer: KEL CORPORATION	

Communication Cable (between drivers) Model no.: PBC6C0003A (Type R only)

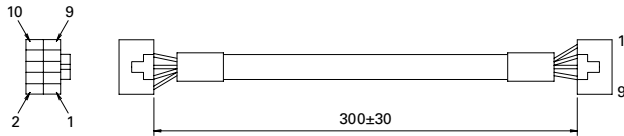

Wiring between connectors

Signal name	CNA pin no.	Color	CNB pin no.	Signal name
A	1	Yellow	1	A
B	2	White	2	B
(Y)	3	Brown	3	(Y)
(Z)	4	Blue	4	(Z)
GND	5	Black	5	GND
Vcc	6		6	Vcc
PCA	7	Purple	7	PCA
PCB	8	Green	8	PCB
24V	9		9	24 V
GND	10	Drain	10	GND

Connector set: PBC6C0000A

Manufacturer model no.	Quantity
Housing: PADP-10V-1-S	1
Contact: SPH-002T-P0.5L	10
Manufacturer: J.S.T.	

Limit Input Cable Model no.: PBC7S0010A (Type P only)

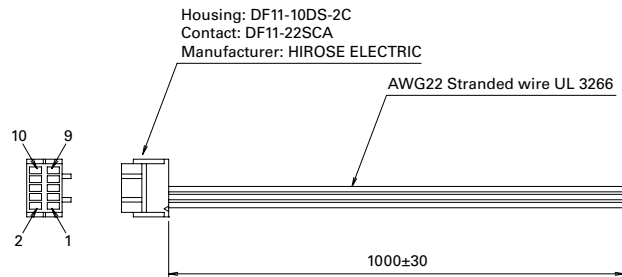

Connections of driver side connectors

Pin no.	Lead wire color	Signal name
1	Red	-
2	Blue	-
3	Black	Forward direction limit
4	Black	Forward direction limit
5	Black	Reverse direction limit
6	Black	Reverse direction limit
7	N.C.	-
8	N.C.	-
9	N.C.	-
10	N.C.	-

Connector set: PBC7S0000A

Manufacturer model no.	Quantity
Housing: DF11-10DS-2C	1
Contact: DF11-2428SCA	10
Manufacturer: HIROSE ELECTRIC CO., LTD.	

For DC input (Type M)

Power cable Model no.: PBC6P0010A

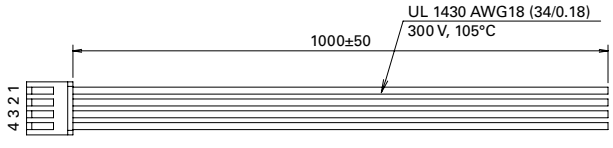

Connections of driver side connectors

Pin no.	Lead wire color	Signal name
1	Red	DC+24/48V
2	Blue	GND
3	Yellow	(24VDC) *
4	Green	FG

Connector set: PBC6P0000A

Manufacturer model no.	Quantity
Connector: VHR-4N	1
Contact: SVH-41TP1.1	4
Manufacturer: J.S.T.	

* Connect control circuit power supply only for drivers with model numbers ending with "1."

Motor extension cable Model no.: PBC6M0030A

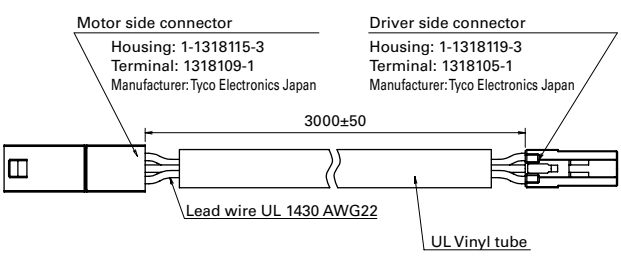

Connections of motor side connectors

Pin no.	Lead wire color	Signal name
A1	Blue	Motor lead wire
B1	Orange	Motor lead wire
A2	Red	Motor lead wire
B2	Yellow	Motor lead wire
A3	White	Brake lead wire
B3	Black	Brake lead wire

Connections of driver side connectors

Pin no.	Lead wire color	Signal name
1 (A1)	Blue	Motor lead wire
2 (B1)	Orange	Motor lead wire
3 (A2)	Red	Motor lead wire
4 (B2)	Yellow	Motor lead wire
5 (A3)	White	Brake lead wire
6 (B3)	Black	Brake lead wire

Connector set: PBC6M0000A

Manufacturer model no.	Quantity
Housing: 1-1318115-3	1
Terminal: 1318109-1	6
Housing: 1-1318119-3	1
Terminal: 1318105-1	6
Manufacturer: Tyco Electronics Japan G.K.	

Encoder extension cable Model no.: PBC6E0030A

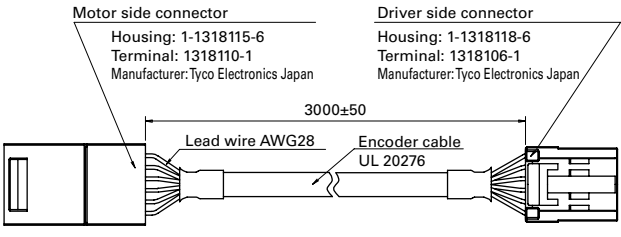

Connections of motor side connectors

Pin no.	Lead wire color	Signal name
A1	Blue	CHANNEL A
B1	Brown	CHANNEL A
A2	Green	CHANNEL B
B2	Purple	CHANNEL B
A3	White	CHANNEL Z
B3	Yellow	CHANNEL Z
A4	Red	+5V
B4	Black	0V
A5	N.C.	-
B5	Orange	OVER HEAT
A6	Black	Shield
B6	N.C.	-

Connections of driver side connectors

Pin no.	Lead wire color	Signal name
1 (A1)	Blue	CHANNEL A
2 (B1)	Brown	CHANNEL A
3 (A2)	Green	CHANNEL B
4 (B2)	Purple	CHANNEL B
5 (A3)	White	CHANNEL Z
6 (B3)	Yellow	CHANNEL Z
7 (A4)	Red	+5V
8 (B4)	Black	0V
9 (A5)	N.C.	-
10 (B5)	Orange	OVER HEAT
11 (A6)	Black	Shield
12 (B6)	N.C.	-

Connector set: PBC6E0000A

Manufacturer model no.	Quantity
Housing: 1-1318115-6	1
Terminal: 1318110-1	10
Housing: 1-1318118-6	1
Terminal: 1318106-1	10
Manufacturer: Tyco Electronics Japan G.K.	

I/O signal cable (unshielded) Model no.: PBC5S0010A

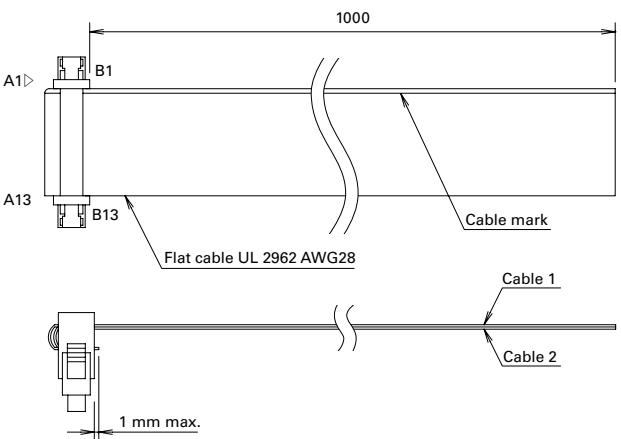

Cable connection

Cable 1	Cable 2
A1-No. 1	B1-No. 14
A2-No. 2	B2-No. 15
A3-No. 3	B3-No. 16
A4-No. 4	B4-No. 17
A5-No. 5	B5-No. 18
A6-No. 6	B6-No. 19
A7-No. 7	B7-No. 20
A8-No. 8	B8-No. 21
A9-No. 9	B9-No. 22
A10-No. 10	B10-No. 23
A11-No. 11	B11-No. 24
A12-No. 12	B12-No. 25
A13-No. 13	B13-No. 26

Connector set: PBC5S0000A

Manufacturer model no.	Quantity
Connector: 8822E-026-171D-F	1
Manufacturer: KEL CORPORATION	

Options Unit in figures: mm

For DC input (Type M)

I/O signal cable (shielded) Model no.: PBC5S0010C

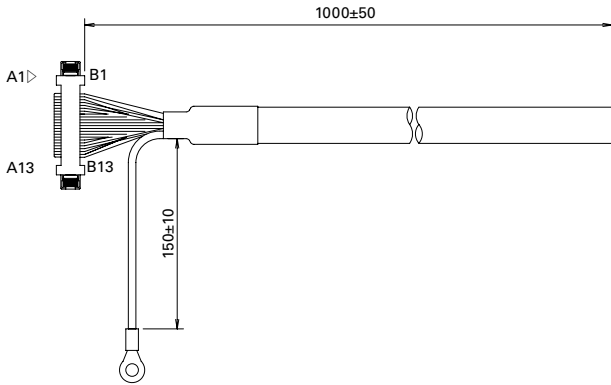

CN wiring

CN1 pin no.	Mark indication	Mark	Wire color
A1		Red	Orange
A2		Black	Orange
A3		Red	Gray
A4		Black	Gray
A5		Red	White
A6		Black	White
A7		Red	Yellow
A8		Black	Yellow
A9		Red	Pink
A10		Black	Pink
A11		Red	Orange
A12		Black	Orange
A13		Red	Gray

CN1 pin no.	Mark indication	Mark	Wire color
B1		Black	Gray
B2		Red	Gray
B3		Black	White
B4		Red	White
B5		Black	Yellow
B6		Red	Yellow
B7		Black	Pink
B8		Red	Pink
B9		Black	Orange
B10		Red	Orange
B11		Black	Gray
B12		Red	Gray
B13		Black	White

Connector set: PBC5S0000A

Manufacturer model no.	Quantity
Connector: 8822E-026-171D-F	1

Manufacturer: KEL CORPORATION

Communication cable (between drivers) Model no.: PBC6C0003A

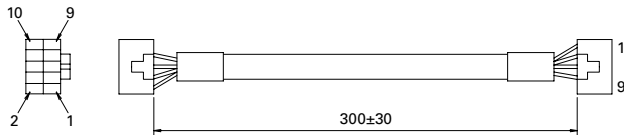

Wiring between connectors

Signal name	CNA pin no.	Wire color	CNB pin no.	Signal name
A	1	Yellow	1	A
B	2	White	2	B
(Y)	3	Brown	3	(Y)
(Z)	4	Blue	4	(Z)
GND	5	Black	5	GND
Vcc	6	Red	6	Vcc
—	7	Purple	7	—
—	8	Green	8	—
—	9	—	9	—
FG	10	Drain	10	FG

Connector set: PBC6C0000A

Manufacturer model no.	Quantity
Housing: PADP-10V-1-S	1

Contact: SPH-002T-P0.5L

Manufacturer: J.S.T.

For DC input (Type P Multi-axis, Type E Multi-axis)

Power cable Model no.: PBC10P0010A, PBC10P0020A

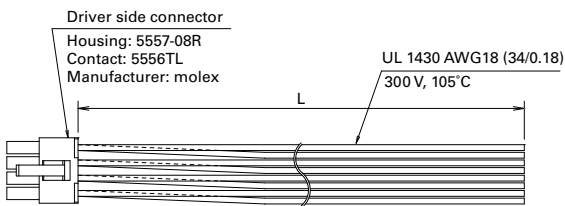

Cable length: L (m)	Model no.
1.0	PBC10P0010A
2.0	PBC10P0020A

Connections of driver side connectors

CN1, CN2 pin no.	Name	Lead wire color
1	FG	Green
2	Control circuit power supply ground	Gray
3	Main circuit power supply ground	Blue
4	Main circuit power supply 24/48 VDC	Red
5	FG	Green
6	Control circuit power supply 24 VDC	Yellow
7	Main circuit power supply ground	Blue
8	Main circuit power supply 24/48 VDC	Red

Connector set: PBC10P0000A

Manufacturer model no.	Quantity
Connector: 5557-08R_NATURAL	1

Contact: 5556TL

Manufacturer: Molex Japan Co., Ltd.

Power cable (between drivers) Model no.: PBC10P0002B

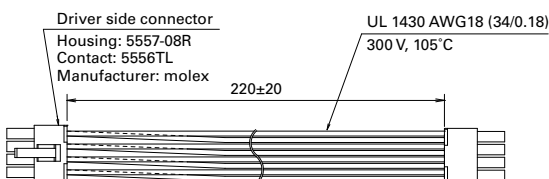

Connections of driver side connectors

CN1, CN2 pin no.	Name	Lead wire color
1	FG	Green
2	Control circuit power supply ground	Gray
3	Main circuit power supply ground	Blue
4	Main circuit power supply 24/48 VDC	Red
5	FG	Green
6	Control circuit power supply 24 VDC	Yellow
7	Main circuit power supply ground	Blue
8	Main circuit power supply 24/48 VDC	Red

Connector set: PBC10P0000A

Manufacturer model no.	Quantity
Connector: 5557-08R_NATURAL	1

Contact: 5556TL

Manufacturer: Molex Japan Co., Ltd.

For DC input (Type P Multi-axis, Type E Multi-axis)

Motor extension cable Model no.: PBC8M0010A, PBC8M0030A, PBC8M0050A

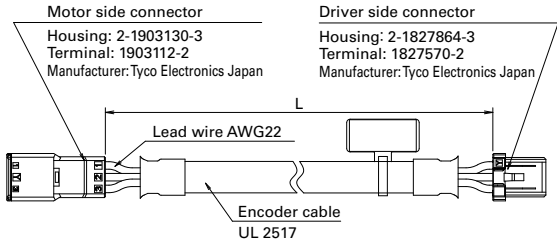

Cable length: L (m)	Model no.
1.0	PBC8M0010A
3.0	PBC8M0030A
5.0	PBC8M0050A

Connections of encoder side connectors

Pin no.	Lead wire color	Signal name
A1	Blue	Motor lead wire
B1	Orange	Motor lead wire
A2	Red	Motor lead wire
B2	Yellow	Motor lead wire
A3	White	Brake lead wire
B3	Black	Brake lead wire

Connections of driver side connectors

Pin no.	Lead wire color	Signal name
A1	Blue	Motor lead wire
B1	Orange	Motor lead wire
A2	Red	Motor lead wire
B2	Yellow	Motor lead wire
A3	White	Brake lead wire
B3	Black	Brake lead wire

Connector set: PBC8M0000A

Manufacturer model no.	Quantity
Housing: 2-1827864-3	1
Terminal: 1827570-2	6
Housing: 2-1903130-3	1
Terminal: 1903112-2	6

Manufacturer: Tyco Electronics Japan G.K.

Encoder extension cable Model no.: PBC7E0010A, PBC7E0030A, PBC7E0050A

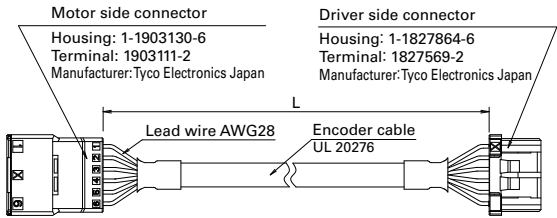

Cable length: L (m)	Model no.
1.0	PBC7E0010A
3.0	PBC7E0030A
5.0	PBC7E0050A

Connections of encoder side connectors

Pin no.	Lead wire color	Optical incremental	Battery-less optical absolute
A1	Blue	CHANNEL A	ES+
B1	Brown	CHANNEL A	ES-
A2	Green	CHANNEL B	-
B2	Purple	CHANNEL B	-
A3	White	CHANNEL Z	-
B3	Yellow	CHANNEL Z	-
A4	Red	+5 V	+5 V
B4	Black	0 V	0 V
A5	N.C.	-	-
B5	Orange	OVER HEAT	-
A6	Black	Shield	Shield
B6	N.C.	-	-

Connections of driver side connectors

Pin no.	Lead wire color	Optical incremental	Battery-less optical absolute
A1	Blue	CHANNEL A	ES+
B1	Brown	CHANNEL A	ES-
A2	Green	CHANNEL B	-
B2	Purple	CHANNEL B	-
A3	White	CHANNEL Z	-
B3	Yellow	CHANNEL Z	-
A4	Red	+5 V	+5 V
B4	Black	0 V	0 V
A5	N.C.	-	-
B5	Orange	OVER HEAT	-
A6	Black	Shield	Shield
B6	N.C.	-	-

Connector set: PBC7E0000A

Manufacturer model no.	Quantity
Housing: 1-1827864-6	1
Terminal: 1827569-2	10
Housing: 1-1903130-6	1
Terminal: 1903111-2	10

Manufacturer: Tyco Electronics Japan G.K.

Options

Unit in figures: mm

For DC input (Type P Multi-axis, Type E Multi-axis)

I/O signal cable Model no.: PBC8S0010C (Type P Multi-axis only)

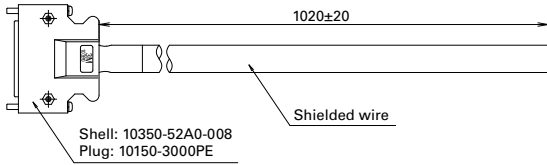

Connector wiring: Terminal name

Terminal number	Signal name	Insulator color	Print mark type	Print mark color	Terminal number	Signal name	Insulator color	Print mark type	Print mark color
1	CW1+	Orange	1	Red	26	CW3+	White	3	Black
2	CW1-	Orange	1	Black	27	CW3-	Yellow	3	Red
3	CCW1+	Gray	1	Red	28	CCW3+	Yellow	3	Black
4	CCW1-	Gray	1	Black	29	CCW3-	Pink	3	Red
5	CW2+	White	1	Red	30	CW4+	Pink	3	Black
6	CW2-	White	1	Black	31	CW4-	Orange	4	Red
7	CCW2+	Yellow	1	Red	32	CCW4+	Orange	4	Black
8	CCW2-	Yellow	1	Black	33	CCW4-	Gray	4	Red
9	COMI	Pink	1	Red	34	01	Gray	4	Black
10	I1	Pink	1	Black	35	02	White	4	Red
11	I2	Orange	2	Red	36	03	White	4	Black
12	I3	Orange	2	Black	37	04	Yellow	4	Red
13	I4	Gray	2	Red	38	05	Yellow	4	Black
14	I5	Gray	2	Black	39	06	Pink	4	Red
15	I6	White	2	Red	40	07	Pink	4	Black
16	I7	White	2	Black	41	08	Orange	5	Red
17	I8	Yellow	2	Red	42	09	Orange	5	Black
18	I9	Yellow	2	Black	43	010	Gray	5	Red
19	I10	Pink	2	Red	44	011	Gray	5	Black
20	I11	Pink	2	Black	45	012	White	5	Red
21	I12	Orange	3	Red	46	013	White	5	Black
22	I13	Orange	3	Black	47		Yellow	5	Red
23		Gray	3	Red	48		Yellow	5	Black
24		Gray	3	Black	49	COMO	Pink	5	Red
25		White	3	Red	50	COMO	Pink	5	Black
						Drain wire	Shielding*		

Connector set: PBC8S0000C

Manufacturer model no.	Quantity
Shell kit: 10350-52A0-008	1
Plug: 10150-3000PE	1
Manufacturer: 3M Japan Limited	

* Follow instructions on the diagram for shielding drain wires.

Print mark type

Mark type	Shape
No. 1	— — — — —
No. 2	— — — — —
No. 3	— — — — —
No. 4	— — — — —
No. 5	— — — — —

Regenerative unit (Unit: mm)

Model no.: PBFE-02

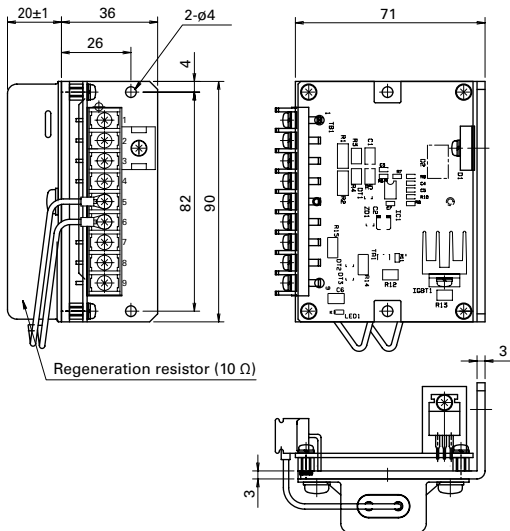

* TB1: Terminal block wiring screw M3
Tightening torque 0.6 N·m

** The external regenerative resistor is installed on the back side.

For DC input (Type E Multi-axis)

PC communication cable Model no.: AL-00896515-01
Model no.: AL-00896515-02

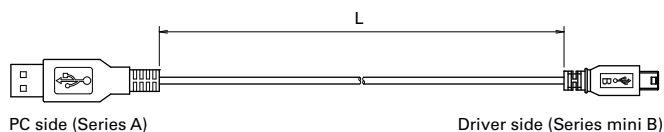

Cable length: L (m)	Model no.
1.0	AL-00896515-01
2.0	AL-00896515-02

I/O signal cable Model no.: PBC9S0010C

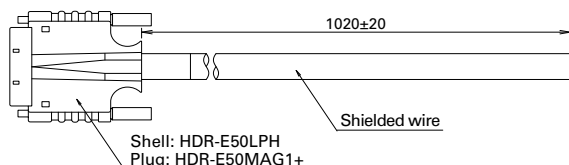

Connector wiring: Terminal name

Terminal number	Signal name	Insulator color	Print mark type	Print mark color
1	COM1	Orange	1	Red
2	COM1	Orange	1	Black
3	NLMT1	Gray	1	Red
4	PLMT1	Gray	1	Black
5	HOME1	White	1	Red
6	TPRB1	White	1	Black
7	NLMT2	Yellow	1	Red
8	PLMT2	Yellow	1	Black
9	HOME2	Pink	1	Red
10	TPRB2	Pink	1	Black
11	NLMT3	Orange	2	Red
12	PLMT3	Orange	2	Black
13	HOME3	Gray	2	Red
14	TPRB3	Gray	2	Black
15	NLMT4	White	2	Red
16	PLMT4	White	2	Black
17	HOME4	Yellow	2	Red
18	TPRB4	Yellow	2	Black
19	N.C	Pink	2	Red
20	N.C	Pink	2	Black
21	N.C	Orange	3	Red
22	N.C	Orange	3	Black
23	N.C	Gray	3	Red
24	N.C	Gray	3	Black
25	N.C	White	3	Red

Terminal number	Signal name	Insulator color	Print mark type	Print mark color
26	OUT1	Yellow	3	Red
27	OUT1G	Yellow	3	Black
28	OUT2	Pink	3	Red
29	OUT2G	Pink	3	Black
30	OUT3	Orange	4	Red
31	OUT3G	Orange	4	Black
32	OUT4	Gray	4	Red
33	OUT4G	Gray	4	Black
34	OUT5	White	4	Red
35	OUT5G	White	4	Black
36	OUT6	Yellow	4	Red
37	OUT6G	Yellow	4	Black
38	OUT7	Pink	4	Red
39	OUT7G	Pink	4	Black
40	OUT8	Orange	5	Red
41	OUT8G	Orange	5	Black
42	OUT9	Gray	5	Red
43	OUT9G	Gray	5	Black
44	OUT10	White	5	Red
45	OUT10G	White	5	Black
46	OUT11	Yellow	5	Red
47	OUT11G	Yellow	5	Black
48	OUT12	Pink	5	Red
49	OUT12G	Pink	5	Black
50	N.C	White	3	Black

Connector set: PBC9S0000C

Manufacturer model no.	Quantity
Shell kit: HDR-E50LPH	1
Plug: HDR-E50MAG1+	1

Manufacturer: HONDA TSUSHIN KOGYO CO., LTD.

Print mark type

Mark type	Shape
No. 1	—
No. 2	— —
No. 3	— — —
No. 4	— — — —
No. 5	— — — — — (連続)

Safety Precautions

The products in this catalog are designed to be used with general industrial devices. When using, pay sufficient attention to the following:

- Read the Instruction Manual carefully prior to installation, assembly, and/or operation for the correct usage of the product.
- Never attempt to disassemble or alter the product in any way.
- Contact us or your point of sale for installation or maintenance services of the product.
- Regarding the following uses of the product, consult us in advance because special considerations are required for operation, maintenance, and management such as dualization of systems, introduction of an emergency generator, and so forth.

- ① Use in medical equipment that may affect people's lives or cause bodily injury
- ② Use in transportation systems or transport-related equipment such as trains or elevators, that may affect people's lives or cause bodily injury
- ③ Use in computer systems that may have an impact on society or on the public
- ④ Use in other devices that have a major impact on human safety or on maintaining public operations

- In addition to the above, contact us or your point of sale for use in an environment where vibrations occur, such as in automobiles or transportation systems.
- For use in space, aviation, or nuclear power-related applications, contact us or your point of sale.
- The products shown in this catalog are subject to Japanese Export Control Law. Diversion contrary to the law of exporting country is prohibited.

Safety Information

Warning Labels on Products

Products bear the following Warning Labels to indicate precautions, depending on the model.



This label is attached to high voltage parts such as electrically charged or cover-protected parts, indicating the risk of electric shock.



必ずアース線を接続して下さい
Use proper grounding techniques.

This label is attached to the GND terminals of a driver, recommending that the terminals should be well grounded.



危険
WARNING
注意
May Cause electric shock

This label is attached to certain areas of a driver where voltages exceeding specified limits are used, drawing attention to the risk of electric shock.



Indicates that the motor may get hot, resulting in burns.



Indicates that the motor should be grounded.

Safety Alert Symbols

The following symbols are used in the manual to indicate potential hazardous situations and important actions.



DANGER Denotes immediate hazards that may cause severe bodily injury or death as a result of incorrect operation.



CAUTION Denotes hazards that could cause bodily injury and product or property damage as a result of incorrect operation.

Even those hazards denoted by the  CAUTION symbol could lead to a serious accident. Make sure to strictly follow these safety precautions.



PROHIBITED Indicates actions that must not be allowed to occur (prohibited actions).



MANDATORY Indicates actions that must be carried out (mandatory actions).

DANGER

General

1. Do not use the product in an explosive, flammable or corrosive atmosphere, watery place or near a combustible material. Doing so may cause injury or fire.
2. Have a person with expert knowledge on hand for performing the transportation, installation, wiring, operation, maintenance or inspection of the product. Without such knowledge, it may cause an electric shock, injury or fire.
3. Do not work on wiring, maintenance servicing or inspection with the electric power on. Perform either of those five minutes after turning the power off. Failure to do so may cause an electric shock.
4. When the protective functions of the product is activated, turn the power off immediately and eliminate the cause. If continuing the operation without eliminating the cause, the product may operate improperly and cause injury or a breakdown of the system devices.
5. The motor may have step-out during operation or when it stops depending on the magnitude of the load. Before using this product, perform adequate trial operations under the maximum load conditions to check that the product operates reliably. Failure to do so may cause a breakdown of the system. (When the product is used to drive upward/downward, the load may fall off due to step-out.)
6. Do not touch the internal parts of the driver. Doing so may cause an electric shock.

Wiring

7. Do not connect the motor directly to a commercial power outlet. Doing so may cause an electric shock, injury or fire. Power should be supplied to the motor through the driving circuit.
8. Use an electric power source within the rated input voltage. Using otherwise may cause fire or an electric shock.
9. Connect the driver and motor to the ground. Using without grounding may cause an electric shock.
10. Do not harm, forcibly put a stress, or load a heavy article on the cable or get it caught between the articles. Doing so may cause an electric shock.
11. Perform wiring with the power cable as instructed by the wiring diagram or the Instruction Manual. Doing otherwise may cause an electric shock or fire.
12. Do not move the motor cable, as it is not a movable cable. Doing so may result in electric shock, injury, or fire.

Operation

13. Do not touch the rotating part of the motor during its operation. Touching it may cause injury.
14. Do not reach or touch the electric terminals while electric power is on. Doing so may cause an electric shock.
15. Never disconnect any of the connectors while electric power is on. Doing so may cause an electric shock and corruption.
16. Do not operate this product with live parts exposed. Doing so may result in electric shock.
17. If smoke, fire, unusual smells, or unusual sounds are produced from the driver or motor, turn off the power and stop using this product immediately. Not doing so may result in electric shock, injury, or fire.

CAUTION

General

1. Prior to installation, operation, maintenance servicing or inspection, be sure to read the Instruction Manual and follow the instructions to perform. Failure to follow the instructions may cause an electric shock, injury or fire.
2. Do not use the driver or the motor under conditions that exceed the specification values. Doing so may cause an electric shock, injury or fire.
3. Do not insert a finger or an object into the opening of the product. Doing so may cause an electric shock, injury or fire.
4. Do not use a damaged driver or motor. Doing so may cause

injury, fire or the like.

5. Use the driver and motor in the designated combination. Using otherwise may cause fire or failure.
6. The operating driver, motor, and peripheral devices become very hot. Be careful so as not to get burned.
7. Never disassemble, repair, modify, or remanufacture this product. Doing so may result in electric shock, injury, or fire.
8. Do not remove the nameplate. Using this product with an incorrect rating may result in fire.
9. Be careful that this product does not fall or tip over when handling, as this can be dangerous.

Unpacking

10. Confirm that the bottom and top of the box are facing correctly while unpacking. Failure to do so may cause injury.
11. Confirm that the product is the one that you have ordered. Installing an incorrect product may cause a breakdown.

Wiring

12. Do not measure the insulation resistance or dielectric voltage of the product. Doing so may cause a breakdown. Contact us or your point of sale instead, if such a measurement is required.
13. Perform wiring conforming to the technical standards of electric facility or the wiring rule. Doing otherwise may cause burning or fire.
14. Ensure that wiring are done correctly. Incorrect wiring may cause the motor to run out of control, resulting in injury.
15. Make sure to insulate the included capacitor and terminals for external resistor connection. Failure to do so may cause an electric shock.

Installation

16. Do not step on, or stack heavy items on the product. Doing so may cause injury.
17. Make sure that the intake and exhaust ports are not blocked or stuffed by foreign substances. Failure to do so may cause fire.
18. Make sure to follow the specified driver mounting orientation. Failure to do so may cause failure.
19. Keep a distance as instructed by the Instruction Manual for the driver from the inner surface of the control console or other devices. Failure to do so may cause failure.
20. Place the product with great care so as to prevent from danger such as a tumble or a turnover.
21. Mount the product on an incombustible material such as metal. Failure to do so may cause fire, injury, or damage to product.
22. Do not place combustible material around this product. Failure to do so may result in fire or burns.
23. Be sure to provide an adequate ventilation path when installing this product, and do not block the intake and exhaust ports. Failure to do so may result in electric shock, fire, or device breakdown.
24. Confirm the rotating direction before connecting with the mechanical device. Failure to do so may cause injury or a breakdown.
25. Do not touch the motor output shaft (including the key slot and gears) with your bare hand. Doing so may cause injury.
26. Make sure not to apply excessive force to the output shaft.

Operation

27. The motor is not equipped with any protective device. Take protective measures using an over-current protective relay, a ground fault interrupter, a protective device from excess temperature, and an emergency stopping device. Failure to do so may cause injury or fire.
28. Do not touch the product while the power is on or for a while after the power is turned off since the driver and motor remain very hot. Doing so may cause burns. In particular, the temperature of the motor may rise considerably depending on the operating conditions. Maintain motor surface temperature at 85°C or lower while in use.
29. Stop operations immediately when an emergency occurs. Failure to do so may cause an electric shock, injury, or fire.
30. Do not change adjustment to an extreme, for such a change results in unstable operation and may cause injury.
31. When performing a trial operation, fasten the motor and disconnect it from the mechanical system. Check the operation, then

- connect it to the machine. Failure to do so may cause injury.
32. When the alarm has been activated, eliminate the cause and ensure safety before resuming operations. Failure to do so may cause injury.
 33. When the electric power recovers after a momentary interruption, do not approach the devices because the system may restart operation by itself. (Set the system so as to secure the safety even when it restarts on such occasions.) Failure to do so may cause injury.
 34. Confirm that the electric power supply properly conforms to the product specifications. Failure to do so may cause failure.
 35. The brake mechanism of the motor with the electromagnetic brake is used to hold the movable section and the motor position. Do not use it as a safety measure. Doing so may cause the breakdown of the system.
 36. Firmly stabilize the key when operating the motor with the key individually. Failure to do so may cause injury.

Maintenance

37. Driver and motor frames become very hot. Be careful when performing maintenance or inspection. Failure to do so may cause burns.
38. It is recommended to replace the electrolytic condenser of the driver with a new one for securing the preventive measure after using for 5 years (the expected life in an average operating environment of 40°C). The expected life of the fuse is 10 years in an average operating environment of 40°C. Thus, periodical replacement is recommended.
39. Contact us or your point of sale for repair. If the product is disassembled by the user, it may become inoperable.

Transportation

40. Handle the product with care during transportation so as to prevent from dangers such as tumbling or overturning.
41. Do not hold with the cable or the motor spindle. Doing so may cause trouble or injury.

Disposal

42. When scrapping the driver or stepping motor, handle it as general industrial waste.



Storage

1. Avoid storing this product in places exposed to rain or water drops, or in an environment with hazardous gas or liquid. Failure to do so may cause trouble.

Maintenance

2. Do not disassemble or repair the product. Doing so may cause fire or an electric shock.

General

3. Do not remove the nameplate. Using this product with an incorrect rating may result in fire.



Storage

1. Store the product in a location that is not exposed to sunlight, at a temperature and humidity within the product specifications.
2. If the driver has been stored for a long period (3 years or longer as a general guide), contact us. The capacitance may have decreased with the electrolytic condenser due to the long period storage, which may cause failure.

Operation

3. Install an external emergency stop circuit to turn the power off in the event that operation must be instantly halted.
4. Operate products within the specified ambient temperature and humidity for each.

Transportation

5. Excess loading of the product on the carrier may cause the load to fall in pieces. Follow the instructions given outside the package.

■ Selection materials for each mechanism

The diagrams below depict representative mechanisms and the points used in their selection. Notify us of the information shown here when requesting us to make a selection.

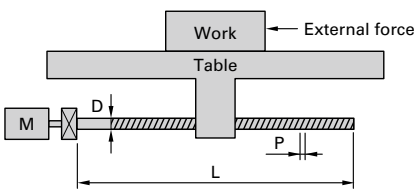
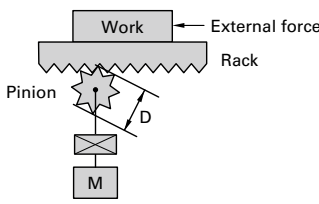
Ball screw			Rack and pinion		
					
External force	F	N	External force	F	N
Weight of work+table	W	kg	Work+rack weight	W	kg
Ball screw diameter	D	m	Pinion diameter	D	m
Ball screw length	L	m	Pinion thickness	L	m
Ball screw lead	P	m	Pinion material specific gravity	ρ	kg/m ³
Ball screw material specific gravity	ρ	kg/m ³	Friction coefficient	μ	
Friction coefficient	μ		Gear ratio*	G	
Gear ratio*	G		Mechanical efficiency	η	
Mechanical efficiency	η				

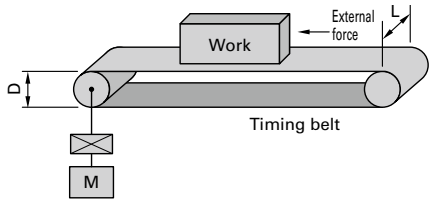
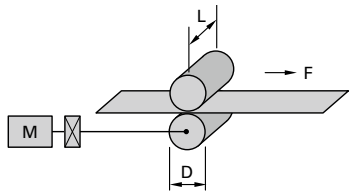
Belt drive			Roll feed		
					
External force	F	N	Sheet tension	F	N
Work+belt weight	W	kg	Roll diameter	D	m
Pulley diameter	D	m	Roll width	L	m
Pulley width	L	m	Roll material specific gravity	ρ	kg/m ³
Pulley material specific gravity	ρ	kg/m ³	Roll moment of inertia	J	kg·m ²
Pulley moment of inertia	J	kg·m ²	Gear ratio*	G	
Gear ratio*	G		Mechanical efficiency	η	
Mechanical efficiency	η				

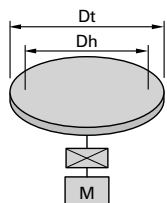
Rotary table		
		
Table weight	W	kg
Table diameter	Dt	m
Table support diameter	Dh	m
Table moment of inertia	J	kg·m ²
Support area friction coefficient	μ	
Gear ratio*	G	
Mechanical efficiency	η	

*How to find the gear ratio (G)

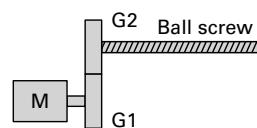

$$G = \frac{\text{Number of ball screw gears (G2)}}{\text{Number of motor gears (G1)}}$$



■ ECO PRODUCTS

SANYO DENKI's ECO PRODUCTS are designed with the concept of lessening impact on the environment in the process from product development to waste. The product units and packaging materials are designed for reduced environmental impact. We have established our own assessment criteria on the environmental impacts applicable to all processes, ranging from design to manufacture. Those products that satisfy the criteria are accredited as ECO PRODUCTS.

Notes before Purchase

The products in this catalog are designed to be used with general industrial devices.

Always follow the following precautions.

- Read the accompanying Instruction Manual carefully prior to using the product.
- If applying to medical devices and other equipment affecting people's lives, please contact us beforehand and take appropriate safety measures.
- If applying to equipment that can have significant effects on society and the general public, please contact us beforehand.

· Do not use this product in an environment where vibration is present, such as in a moving vehicle or shipping vessel.

· Do not perform any retrofitting, re-engineering, or modification to this equipment.

· The products presented in this catalog are meant to be used for general industrial applications. If using for special applications related to aviation and space, nuclear power, electric power, submarine repeaters, and the like, please contact us beforehand.

SANYO DENKI CO., LTD. 3-33-1 Minami-Otsuka, Toshima-ku, Tokyo 170-8451, Japan TEL: +81 3 5927 1020

<https://www.sanyodenki.com>

The names of companies and/or their products specified in this catalog are the trade names, and/or trademarks and/or registered trademarks of such respective companies.

SANMOTION is a trademark of SANYO DENKI CO., LTD.

Specifications are subject to change without notice.

CATALOG No. S0838B018 '21.4.IT