

Fast Switching SCR T7SH __ 46

460A Avg.
(720A RMS)
1400-1800 Volts
80-100 μ sec

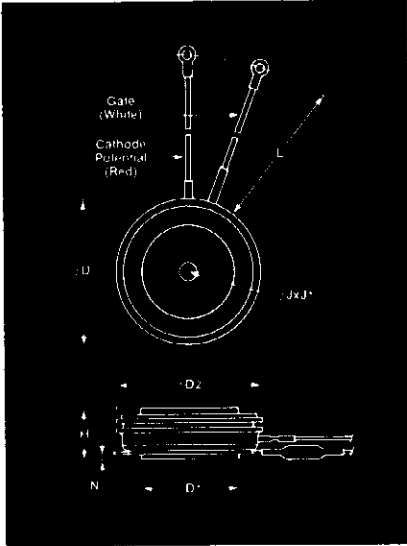

Symbol	Inches		Millimeters	
	Min.	Max.	Min.	Max.
ϕD	1.850	1.900	45.72	48.26
ϕD_1	1.140	1.180	28.96	29.97
ϕD_2	1.760	1.850	44.70	46.99
H	.545	.605	13.84	15.37
ϕJ	.135	.145	3.43	3.68
J_1	.072	.082	1.83	2.08
L	7.75	8.50	196.85	215.90
N	.025		.64	

Creep Distance— .408 in min. (10.36 mm).
Strike Distance— .203 in min. (5.16 mm).
Finish— Nickel Plate.
Approx. Weight— 4 oz. (113 g).
1. Dimension "H" is a clamped dimension.

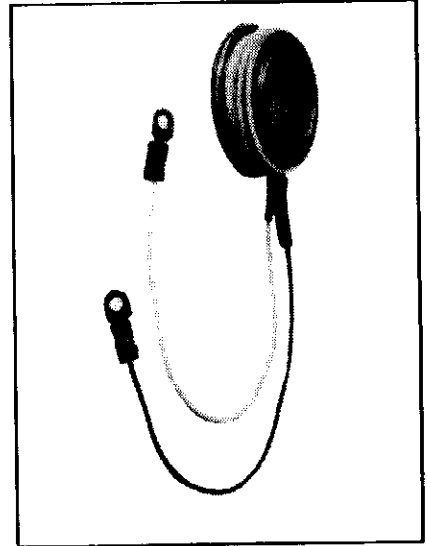

T7S Outline

Features:

- Interdigitated, di/namic Gate Structure
- Hard Commutation Turn-Off
- Forward Blocking Voltage Capabilities to 1800 Volts
- Low Switching Losses at High Frequency
- Soft Cummutation (Feedback Diode) Testing Available
- High di/dt with soft gate control

Applications:

- Induction Heating
- Transportation
- Inverters

Ordering Information

Type	Voltage	Current	Turn-off	Gate current	Leads
	V_{DRM} and V_{RRM} (V)	$I_{T(av)}$ (A)	t_q μ sec	I_{GT} (ma)	Case
	1400 1600 1800	460	80 100	150	T7S

Example: Obtain optimum device performance for your application by selecting proper Order Code.

Type T7SH rated at 460A average with $V_{DRM} = 1600V$, $I_{GT} = 150$ ma, $t_q = 80 \mu$ sec max. and leads—order as:

Type	Voltage	Current	Turn Off	Gate Current	Leads
T 7 S H	1 6	4 6	1	4	D N

**460A Avg.
(720A RMS)
1400-1800 Volts
80-100 μ sec**

**Fast Switching
SCR
T7SH __ 46**

Voltage ②

Blocking State Maximums ($T_J = 125^\circ\text{C}$) **Symbol**

Repetitive peak forward blocking voltage, V V_{DRM}
 Repetitive peak reverse voltage, V V_{RRM}
 Non-repetitive transient peak reverse voltage,
 $t \leq 5.0$ msec, V V_{RSM}
 Forward leakage current, mA peak I_{DRM}
 Reverse leakage current, mA peak I_{RRM}

1400	1600	1800
1400	1600	1800
1500	1700	1900
← 35 →		
← 35 →		

Current

Conducting State Maximums
($T_J = 125^\circ\text{C}$)

Symbol	T7SH __ 46
RMS forward current, A $I_T(rms)$	720
Ave. forward current, A $I_T(av)$	460
One-half cycle surge current ③, A I_{TSM}	6800
I^2t for fusing (for times ≥ 8.3 ms) A ² sec I^2t	301,000
Forward voltage drop at $I_{TM} = 1500A$ and $T_J = 25^\circ\text{C}$, V V_{TM}	2.2
Min. repetitive di/dt ①④⑥ A/ μ sec di/dt	400

Switching

($T_J = 25^\circ\text{C}$)

Symbol	
Max. turn-off time, $I_T = 400A$, $T_J = 125^\circ\text{C}$, $t_p = 100 \mu\text{sec}$, di/dt = 25 A/ μ sec., reapplied dv/dt = 200 V/ μ sec linear to 0.8 V_{DRM} , μsec . ④⑦⑧ .. t_q	80 to 100
Typ. delay time, $I_{TM} = 1000A$ t_d	2.0
$T_D = 8 V_{DRM}$ ④, μsec ④	
Typ. turn-on-time $I_{TM} = 1000A$, μsec t_{on}	3.0
Min. critical dv/dt exponential to .8 V_{DRM} , $T_J = 125^\circ\text{C}$, V/ μ sec ②⑤ dv/dt	300
Min. di/dt, non-repetitive, A/ μ sec ①④⑥ di/dt	800

Gate

Maximum Parameters
($T_J = 25^\circ\text{C}$)

Symbol	
Gate current to trigger at $V_D = 12V$, mA I_{GT}	150
Gate voltage to trigger at $V_D = 12V$, V V_{GT}	3
Non-triggering gate voltage, $T_J = 125^\circ\text{C}$, and rated V_{DRM} , V V_{GDM}	25
Peak forward gate current, A I_{GTM}	4
Peak reverse gate voltage, V V_{GRM}	5
Peak gate power, Watts P_{GM}	16
Average gate power, Watts $P_{G(av)}$	3

Thermal and Mechanical

Symbol	
Min., Max. oper. junction temp., $^\circ\text{C}$ T_J	-40 to +125
Min., Max. storage temp., $^\circ\text{C}$ T_{stg}	-40 to +150
Max. mounting force, lb. ①	2000 to 2400
Thermal resistance ①, double- side cooling, junction to case, $^\circ\text{C}/\text{Watt}$ $R_{\theta JC}$.045
Case to sink, lubricated, $^\circ\text{C}/\text{Watt}$ $R_{\theta CS}$.02

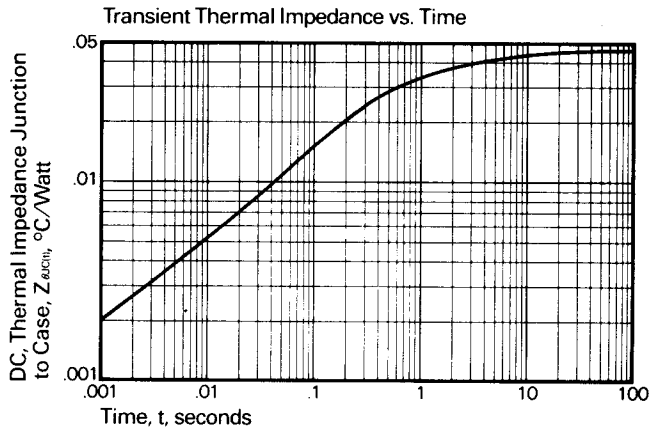
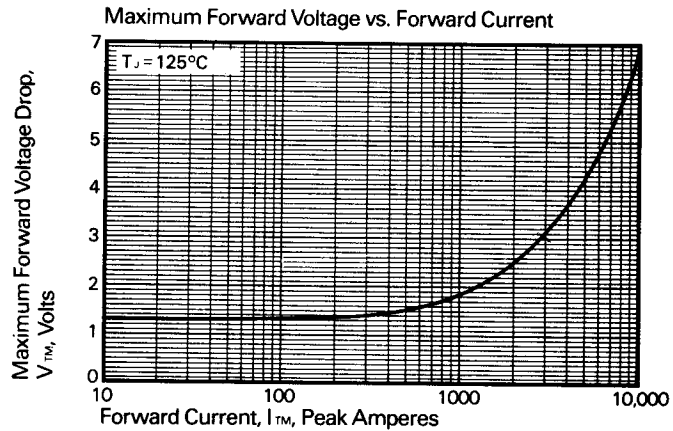

- ① Consult recommended mounting procedures.
- ② Applies for zero or negative gate bias.
- ③ Per JEDEC RS-397, 5.2.2.1.
- ④ With recommended gate drive.
- ⑤ Higher dv/dt ratings available, consult factory.
- ⑥ Per JEDEC standard RS-397, 5.2.2.6.
- ⑦ For operation with antiparallel diode, consult factory.
- ⑧ Other t_q and t_{on} combinations available consult factory.

Fast Switching SCR T7SH 46

460A Avg.
(720A RMS)
1400-1800 Volts
80-100 μ sec

Sinusoidal Current Data

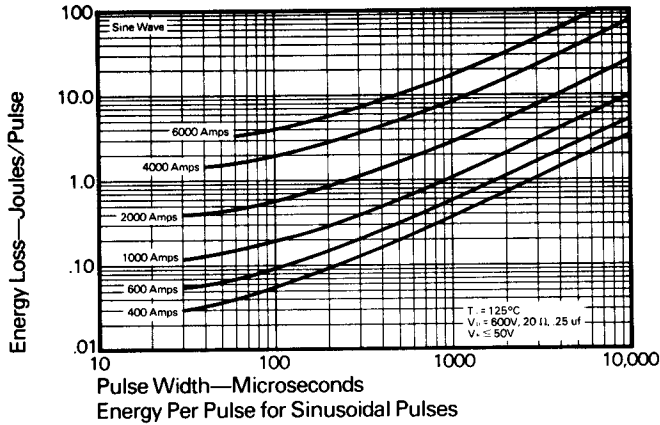

Trapezoidal Wave Current Data

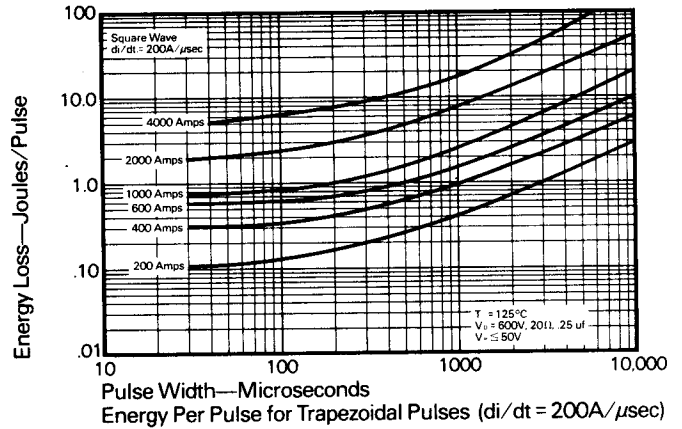
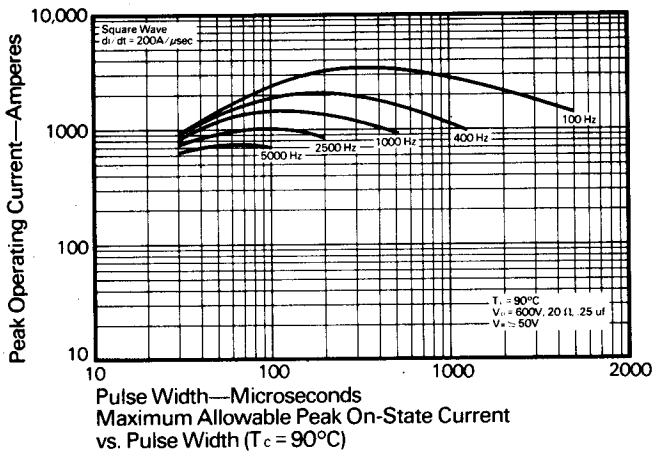
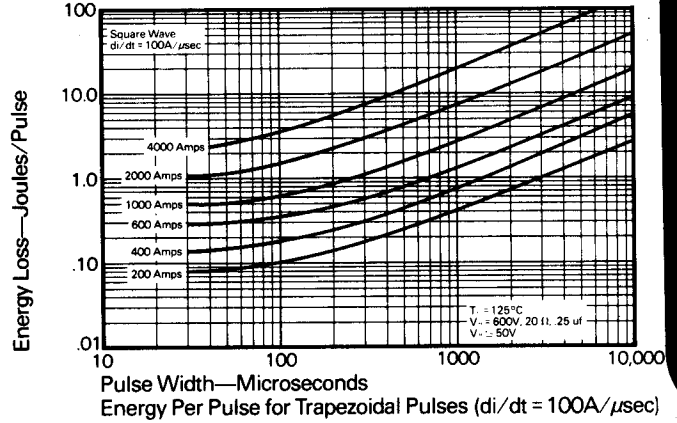
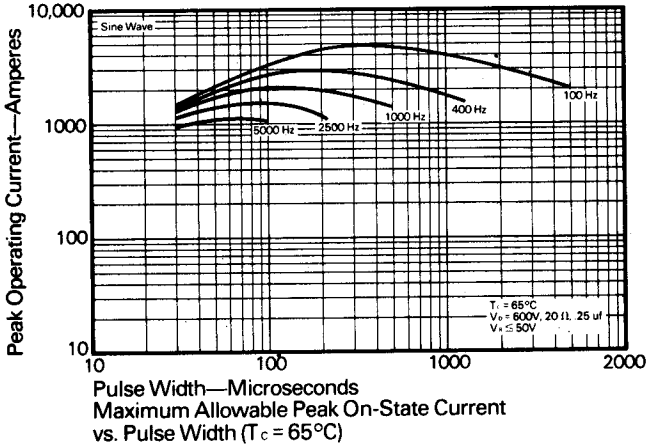
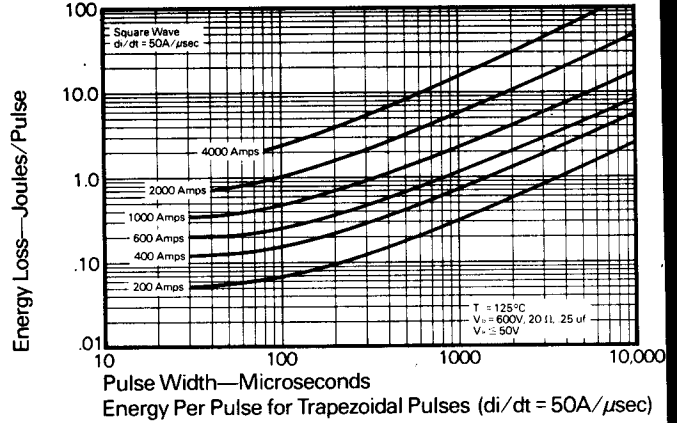

460A Avg.
(720A RMS)
1400-1800 Volts
80-100 μ sec

Fast Switching
SCR
T7SH __ 46

Trapezoidal Wave Current Data ($T_c = 65^\circ\text{C}$)

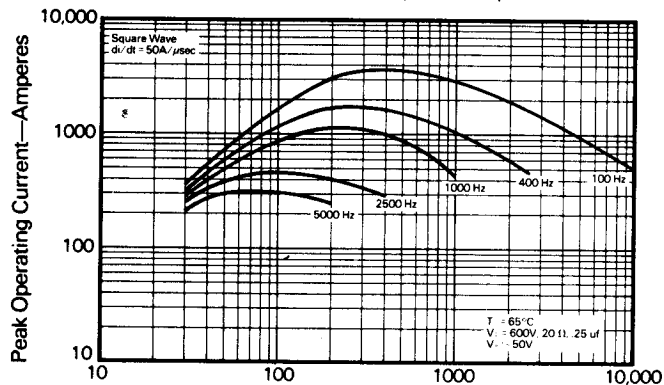

Pulse Width—Microseconds
Maximum Allowable Peak On-State Current
vs. Pulse Width ($di/dt = 50\text{A}/\mu\text{sec}$)

Trapezoidal Wave Current Data ($T_c = 90^\circ\text{C}$)

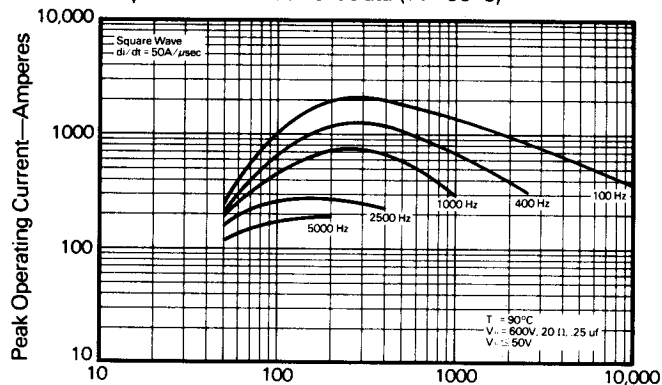

Pulse Width—Microseconds
Maximum Allowable Peak On-State Current
vs. Pulse Width ($di/dt = 50\text{A}/\mu\text{sec}$)

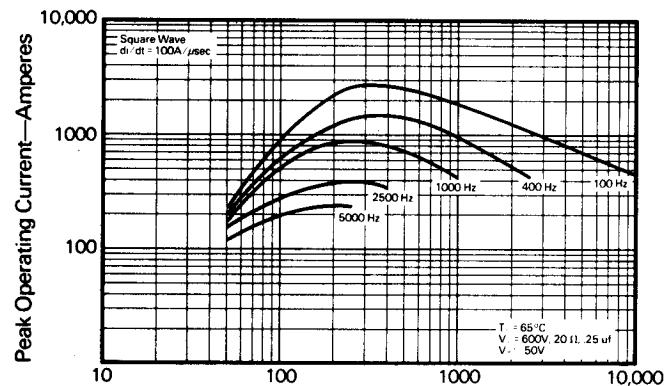

Pulse Width—Microseconds
Maximum Allowable Peak On-State Current
vs. Pulse Width ($di/dt = 100\text{A}/\mu\text{sec}$)

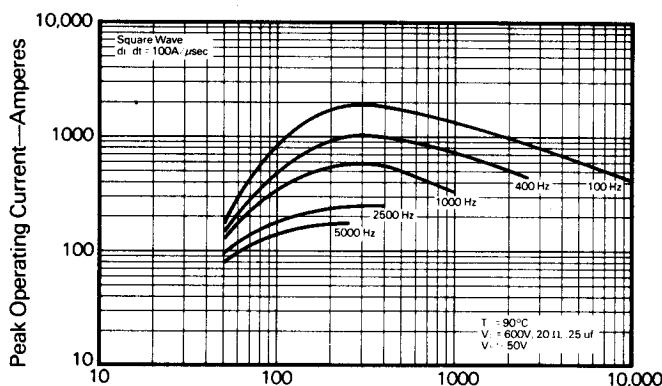

Pulse Width—Microseconds
Maximum Allowable Peak On-State Current
vs. Pulse Width ($di/dt = 100\text{A}/\mu\text{sec}$)

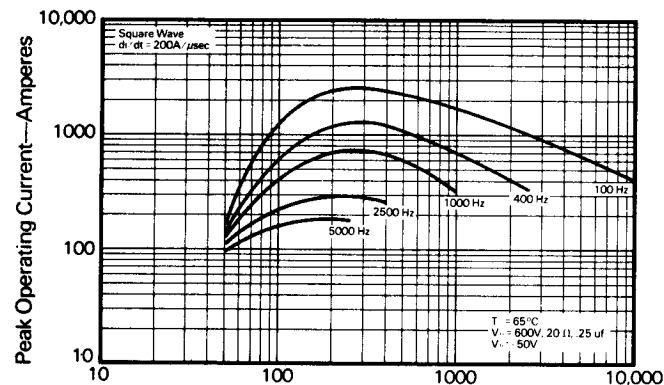

Pulse Width—Microseconds
Maximum Allowable Peak On-State Current
vs. Pulse Width ($di/dt = 200\text{A}/\mu\text{sec}$)

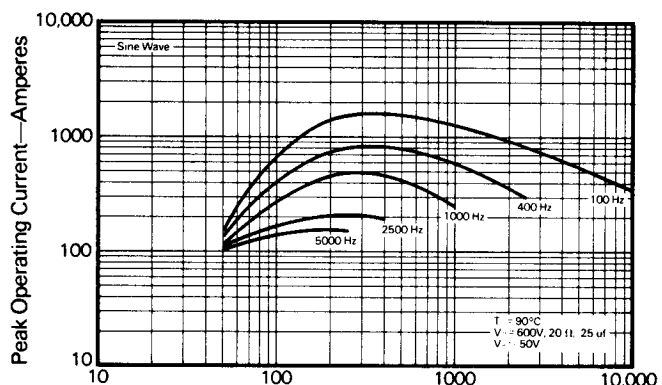

Pulse Width—Microseconds
Maximum Allowable Peak On-State Current
vs. Pulse Width ($di/dt = 200\text{A}/\mu\text{sec}$)