

NTND31225CZ

MOSFET – Small Signal, Complementary, XLLGAS6, 0.65mm x 0.90mm x 0.4mm 20 V



ON Semiconductor®

www.onsemi.com

Features

- Advanced Trench Complementary MOSFET
- Offers a Low $R_{DS(ON)}$ Solution in the Ultra Small 0.65 mm x 0.90 mm Package
- These Devices are Pb-Free, Halogen Free/BFR Free and are RoHS Compliant

Applications

- Small Signal Load Switch with Level Shift
- Analog Switch
- High Speed Interfacing
- Optimized for Power Management in Ultra Portable Products

MAXIMUM RATINGS ($T_J = 25^\circ\text{C}$ unless otherwise specified)

Parameter		Symbol	Value	Unit	
Drain-to-Source Voltage	NMOS	V_{DSS}	20	V	
	PMOS		-20		
Gate-to-Source Voltage	NMOS	V_{GSS}	± 8	V	
	PMOS		± 8		
N-Channel Continuous Drain Current (Note 1)	Steady State	$T_A = 25^\circ\text{C}$	I_D	220	mA
		$T_A = 85^\circ\text{C}$		158	
	$t \leq 5$ s	$T_A = 25^\circ\text{C}$		253	
P-Channel Continuous Drain Current (Note 1)	Steady State	$T_A = 25^\circ\text{C}$	I_D	-127	mA
		$T_A = 85^\circ\text{C}$		-91	
	$t \leq 5$ s	$T_A = 25^\circ\text{C}$		-146	
Power Dissipation (Note 1)	Steady State	$T_A = 25^\circ\text{C}$	P_D	125	mW
		$t \leq 5$ s		166	
Pulsed Drain Current	NMOS	$t_p = 10 \mu\text{s}$	I_{DM}	846	mA
	PMOS			-488	
Source Current (Body Diode)			I_S	200	mA
				-200	
Operating Junction and Storage Temperature		T_J, T_{STG}		-55 to 150	$^\circ\text{C}$
Lead Temperature for Soldering Purposes (1/8" from case for 10 s)		T_L		260	$^\circ\text{C}$

Stresses exceeding those listed in the Maximum Ratings table may damage the device. If any of these limits are exceeded, device functionality should not be assumed, damage may occur and reliability may be affected.

$V_{(BR)DSS}$	$R_{DS(ON)}$ MAX	I_D Max
N-Channel 20 V	1.5 Ω @ 4.5 V	220 mA
	2.0 Ω @ 2.5 V	
	3.0 Ω @ 1.8 V	
	4.5 Ω @ 1.5 V	
P-Channel -20 V	5.0 Ω @ -4.5 V	-127 mA
	6.0 Ω @ -2.5 V	
	7.0 Ω @ -1.8 V	
	10.0 Ω @ -1.5 V	

DEVICE SYMBOL

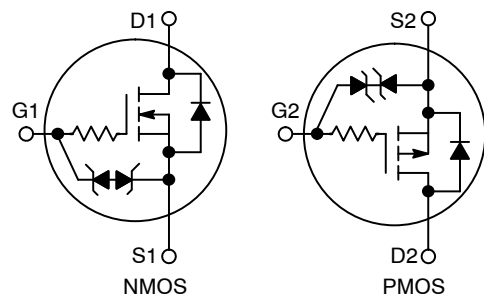

XLLGA6
Case 713AC

MARKING DIAGRAM

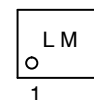

L = Specific Device Code
M = Date Code

PINOUT DIAGRAM

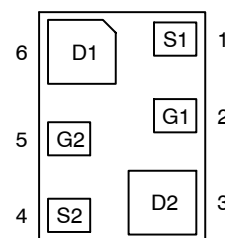

(Bottom View)

ORDERING INFORMATION

See detailed ordering and shipping information on page 4 of this data sheet.

NTND31225CZ

1. Surface-mounted on FR4 board using the minimum recommended pad size, 1 oz Cu.

NTND31225CZ

THERMAL RESISTANCE RATINGS

Parameter	Symbol	Max	Unit
Junction-to-Ambient (Note 2) Steady State $t \leq 5$ s	$R_{\theta JA}$	998 751	$^{\circ}\text{C/W}$

2. Surface-mounted on FR4 board using 1 in sq pad size (Cu area = 1.127 in sq), 1 oz copper

ELECTRICAL CHARACTERISTICS ($T_J = 25^{\circ}\text{C}$ unless otherwise specified)

Parameter	Symbol	FET	Test Condition	Min	Typ	Max	Unit
-----------	--------	-----	----------------	-----	-----	-----	------

OFF CHARACTERISTICS

Drain-to-Source Breakdown Voltage	$V_{(BR)DSS}$	N	$V_{GS} = 0$ V, $I_D = 250$ μA	20			V
		P	$V_{GS} = 0$ V, $I_D = -250$ μA	-20			
Zero Gate Voltage Drain Current	I_{DSS}	N	$V_{GS} = 0$ V, $V_{DS} = 5$ V	$T_J = 25^{\circ}\text{C}$		50	nA
				$T_J = 85^{\circ}\text{C}$		200	
		P	$V_{GS} = 0$ V, $V_{DS} = 16$ V	$T_J = 25^{\circ}\text{C}$		100	nA
				$T_J = 85^{\circ}\text{C}$		-200	
		N	$V_{GS} = 0$ V, $V_{DS} = -5$ V	$T_J = 25^{\circ}\text{C}$		-50	nA
				$T_J = 85^{\circ}\text{C}$		-200	
P	$V_{GS} = 0$ V, $V_{DS} = -16$ V	$T_J = 25^{\circ}\text{C}$		-100	nA		
		$T_J = 85^{\circ}\text{C}$		-200			
Gate-to-Source Leakage Current	I_{GSS}	N	$V_{GS} = 0$ V, $V_{DS} = \pm 5$ V			± 100	nA
		P	$V_{GS} = 0$ V, $V_{DS} = \pm 5$ V			± 100	

ON CHARACTERISTICS

Gate Threshold Voltage	$V_{GS(TH)}$	N	$V_{GS} = V_{DS}$, $I_D = 250$ μA	0.4		1.0	V
		P	$V_{GS} = V_{DS}$, $I_D = -250$ μA	-0.4		-1.0	
Drain-to-Source On Resistance	$R_{DS(ON)}$	N	$V_{GS} = 4.5$ V, $I_D = 100$ mA		0.8	1.5	Ω
			$V_{GS} = 2.5$ V, $I_D = 50$ mA		1.1	2.0	
			$V_{GS} = 1.8$ V, $I_D = 20$ mA		1.4	3.0	
			$V_{GS} = 1.5$ V, $I_D = 10$ mA		1.8	4.5	
		P	$V_{GS} = -4.5$ V, $I_D = -100$ mA		2.1	5.0	
			$V_{GS} = -2.5$ V, $I_D = -50$ mA		2.7	6.0	
			$V_{GS} = -1.8$ V, $I_D = -20$ mA		3.6	7.0	
			$V_{GS} = -1.5$ V, $I_D = -10$ mA		4.2	10.0	
Forward Transconductance	g_{FS}	N	$V_{DS} = 5$ V, $I_D = 125$ mA		0.48		S
		P	$V_{DS} = -5$ V, $I_D = -125$ mA		0.35		
Forward Diode Voltage	V_{SD}	N	$V_{GS} = 0$ V, $I_S = 10$ mA		0.6	1.0	V
		P	$V_{GS} = 0$ V, $I_S = -10$ mA		-0.6	-1.0	

3. Switching characteristics are independent of operating junction temperatures.

Product parametric performance is indicated in the Electrical Characteristics for the listed test conditions, unless otherwise noted. Product performance may not be indicated by the Electrical Characteristics if operated under different conditions.

NTND31225CZ

ELECTRICAL CHARACTERISTICS (T_J = 25°C unless otherwise specified)

Parameter	Symbol	FET	Test Condition	Min	Typ	Max	Unit
CAPACITANCES							
Input Capacitance	C _{ISS}	N	V _{GS} = 0 V, f = 1 MHz, V _{DS} = 15 V		12.3		pF
Output Capacitance	C _{OSS}				3.4		
Reverse Capacitance	C _{RSS}				2.5		
Input Capacitance	C _{ISS}	P	V _{GS} = 0 V, f = 1 MHz, V _{DS} = -15 V		12.8		
Output Capacitance	C _{OSS}				2.8		
Reverse Capacitance	C _{RSS}				2.0		

SWITCHING CHARACTERISTICS, V_{GS} = 4.5 V

Turn-On Delay Time	t _{d(ON)}	N	V _{GS} = 4.5 V, V _{DS} = 15 V, I _D = 200 mA, R _G = 2 Ω		16.5		ns
Rise Time	t _r				25.5		
Turn-Off Delay Time	t _{d(OFF)}				142		
Fall Time	t _f				80		
Turn-On Delay Time	t _{d(ON)}	P	V _{GS} = -4.5 V, V _{DS} = -15 V, I _D = -200 mA, R _G = 2 Ω		37		
Rise Time	t _r				71		
Turn-Off Delay Time	t _{d(OFF)}				280		
Fall Time	t _f				171		

3. Switching characteristics are independent of operating junction temperatures.

Product parametric performance is indicated in the Electrical Characteristics for the listed test conditions, unless otherwise noted. Product performance may not be indicated by the Electrical Characteristics if operated under different conditions.

ORDERING INFORMATION

Device	Package	Shipping†
NTND31225CZTAG	XLLGA6 (Pb-Free)	8000 / Tape & Reel

†For information on tape and reel specifications, including part orientation and tape sizes, please refer to our Tape and Reel Packaging Specifications Brochure, BRD8011/D.

TYPICAL CHARACTERISTICS – P-CHANNEL

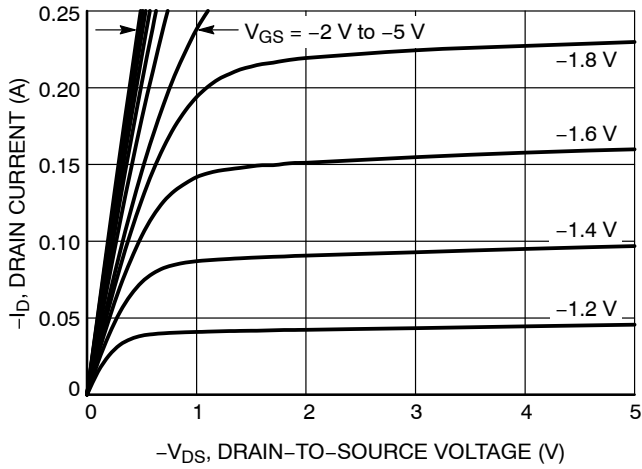

Figure 1. On-Region Characteristics

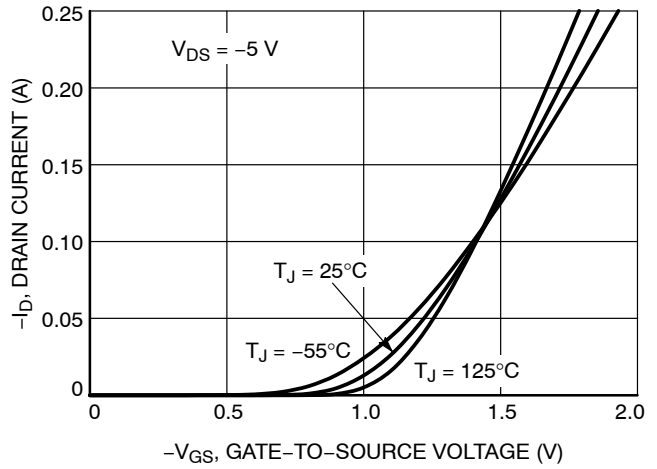

Figure 2. Transfer Characteristics

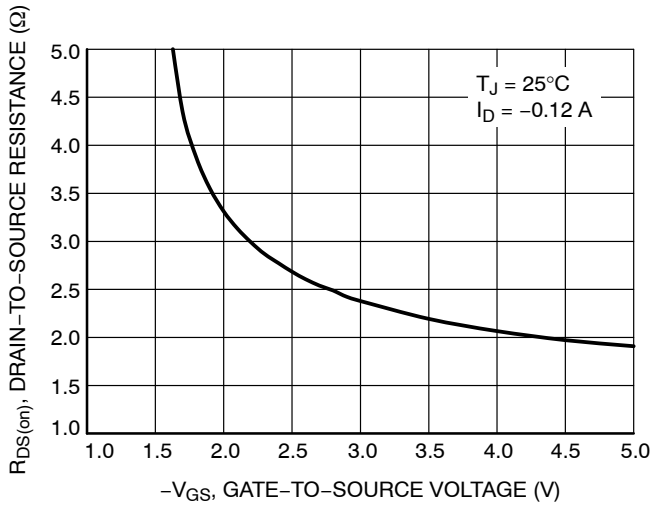

Figure 3. On-Resistance vs. Gate-to-Source Voltage

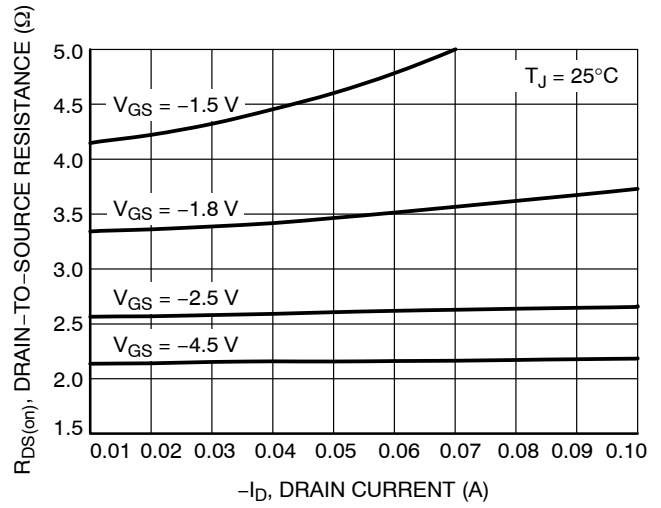

Figure 4. On-Resistance vs. Drain Current and Gate Voltage

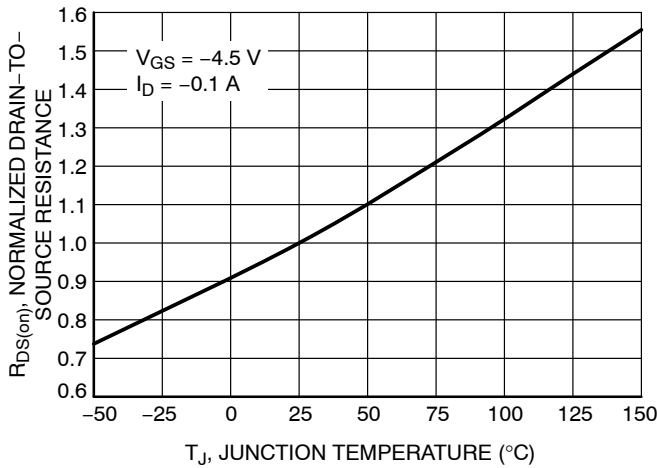

Figure 5. On-Resistance Variation with Temperature

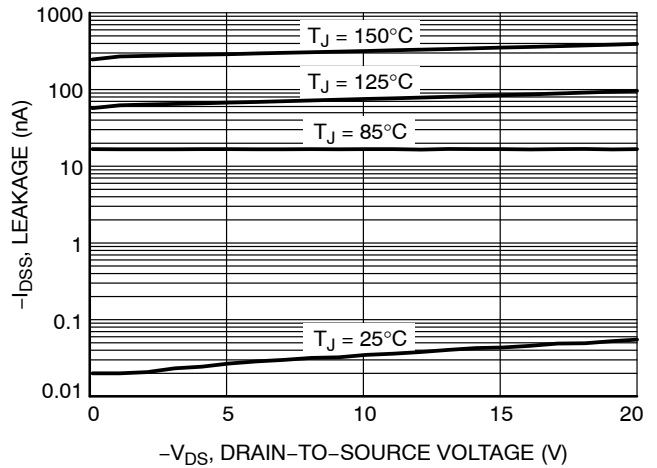

Figure 6. Drain-to-Source Leakage Current vs. Voltage

NTND31225CZ

TYPICAL CHARACTERISTICS – P-CHANNEL

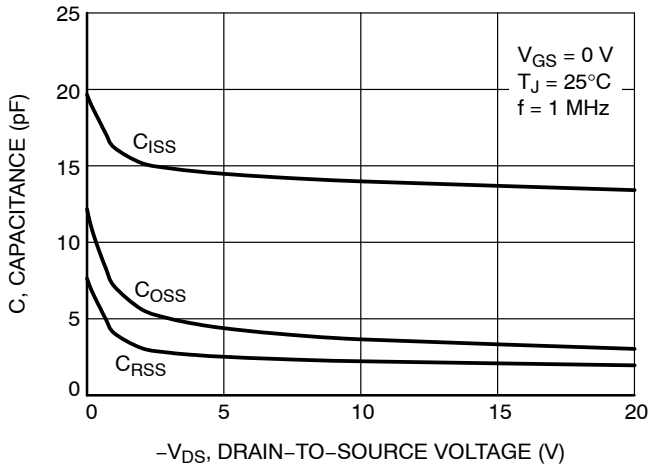

Figure 7. Capacitance Variation

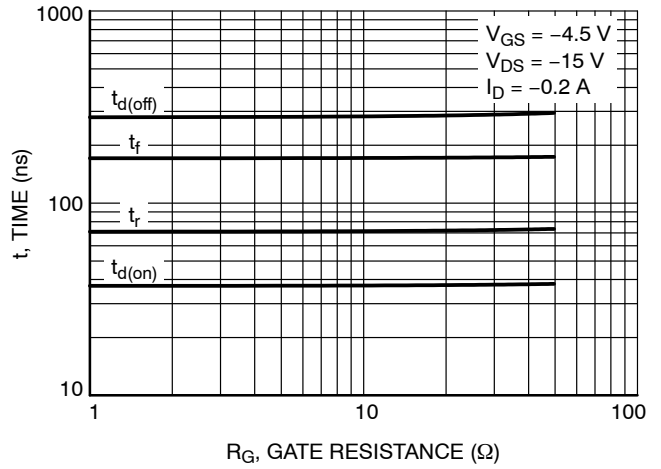

Figure 8. Resistive Switching Time Variation vs. Gate Resistance

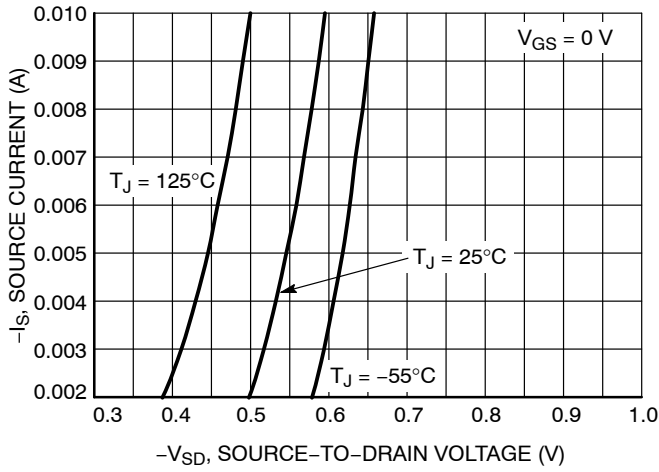

Figure 9. Diode Forward Voltage vs. Current

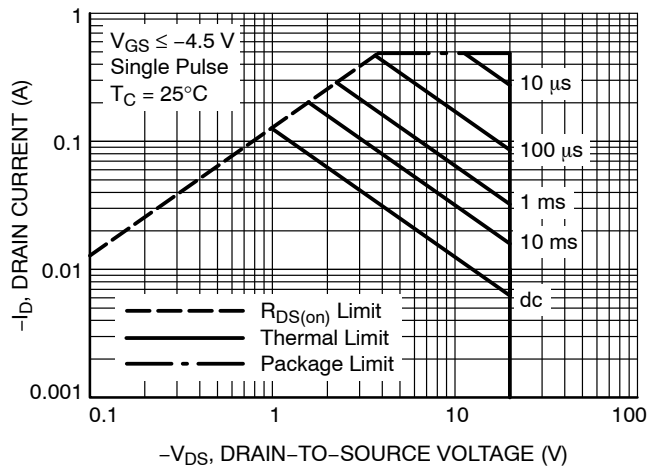

Figure 10. Maximum Rated Forward Biased Safe Operating Area

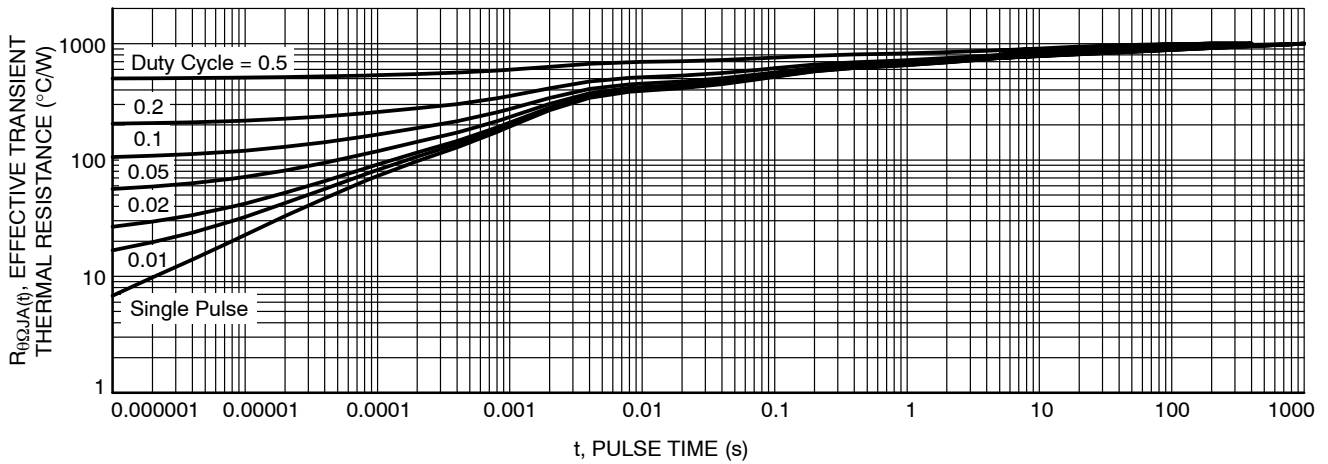

Figure 11. Thermal Response

NTND31225CZ

TYPICAL CHARACTERISTICS – N-CANNEL

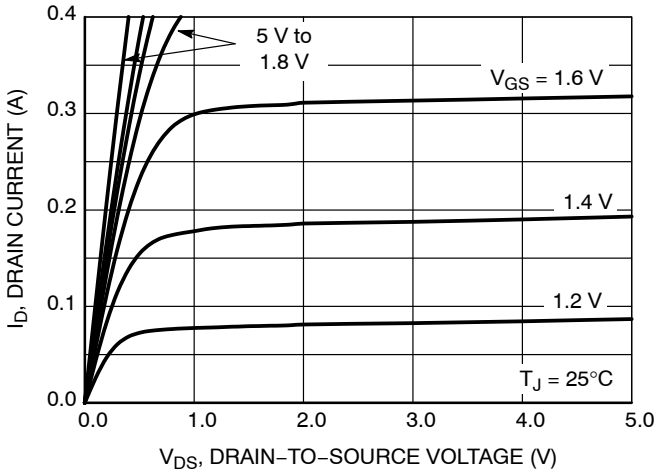

Figure 12. On-Region Characteristics

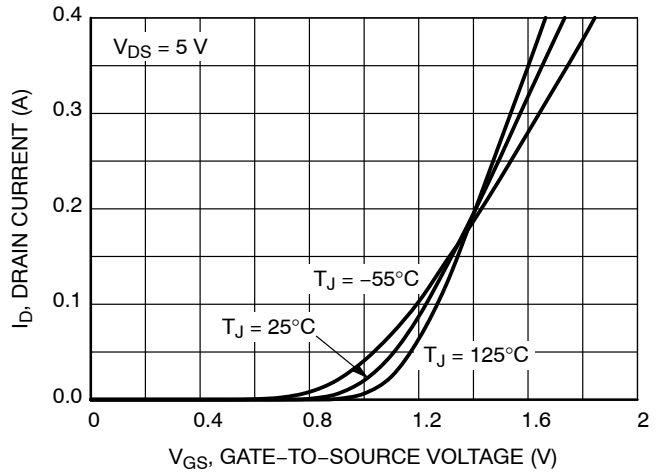

Figure 13. Transfer Characteristics

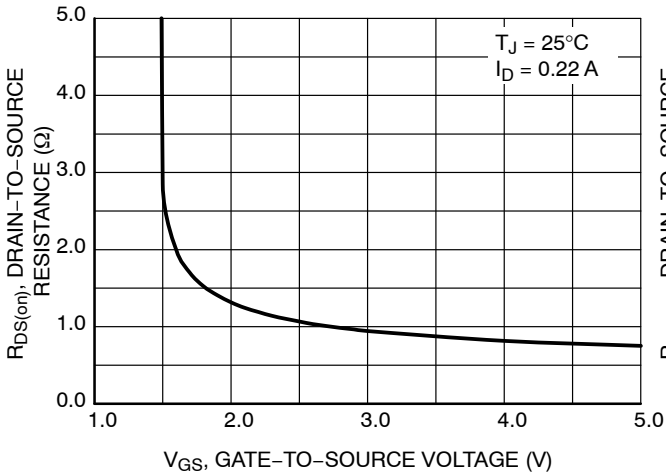

Figure 14. On-Resistance vs. Gate-to-Source Voltage

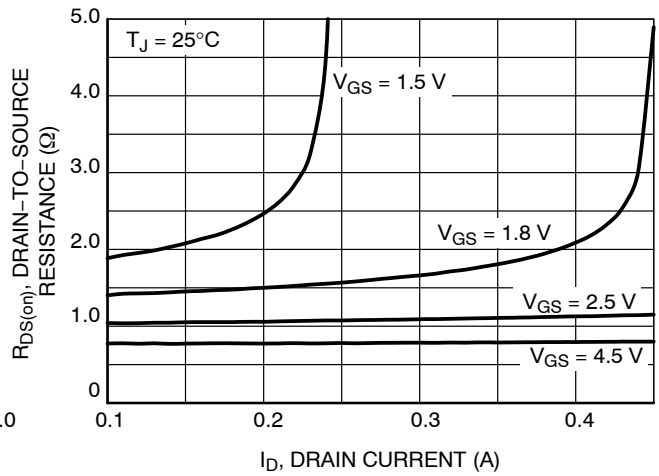

Figure 15. On-Resistance vs. Drain Current and Gate Voltage

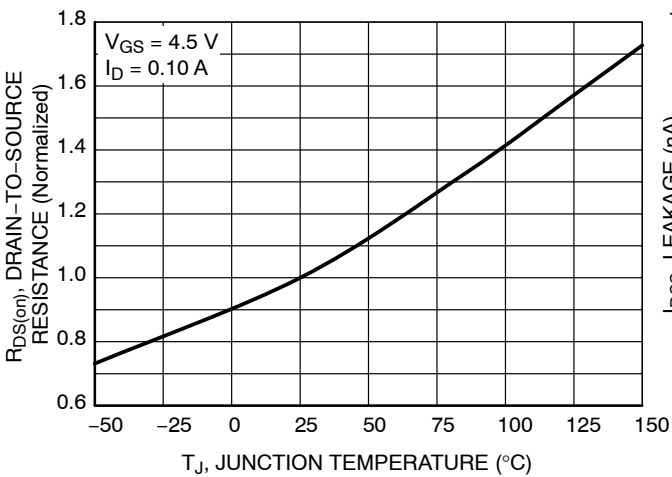

Figure 16. On-Resistance Variation with Temperature

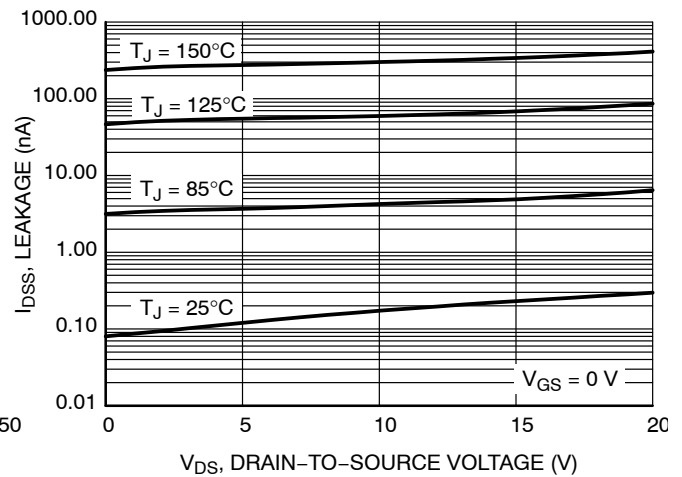

Figure 17. Drain-to-Source Leakage Current vs. Voltage

NTND31225CZ

TYPICAL CHARACTERISTICS – N-CHANNEL

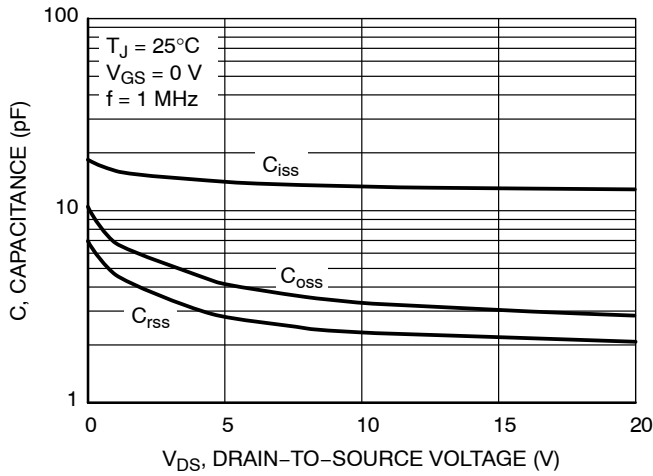

Figure 18. Capacitance Variation

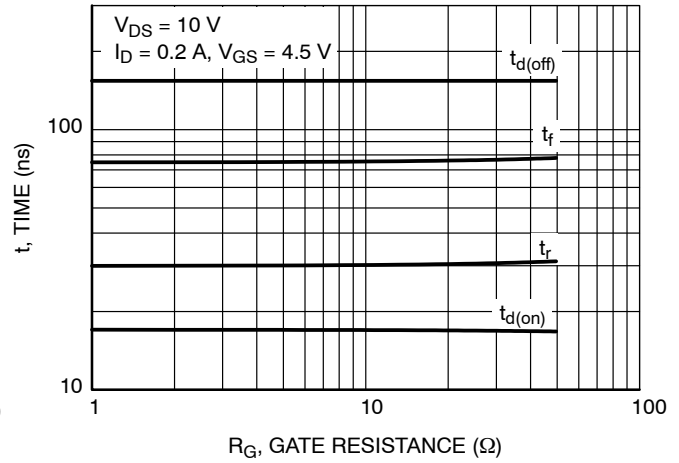

Figure 19. Resistive Switching Time Variation vs. Gate Resistance

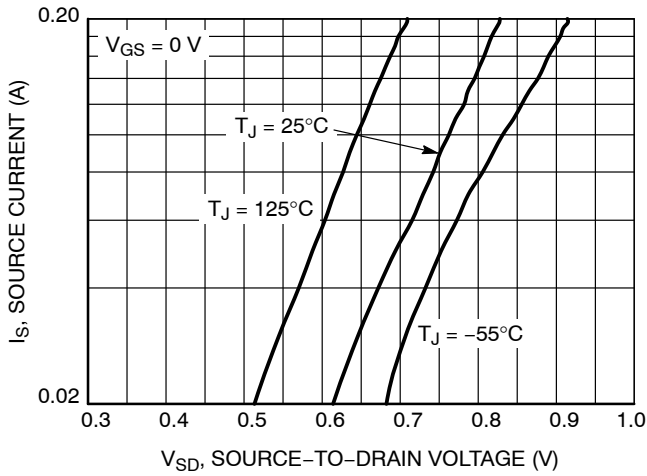

Figure 20. Diode Forward Voltage vs. Current

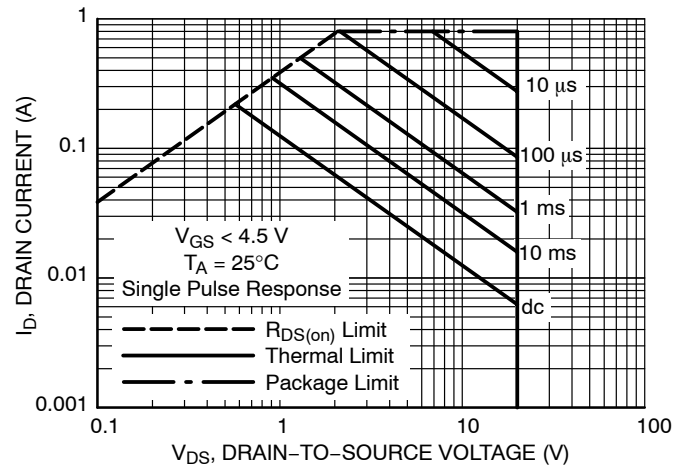

Figure 21. Maximum Rated Forward Biased Safe Operating Area

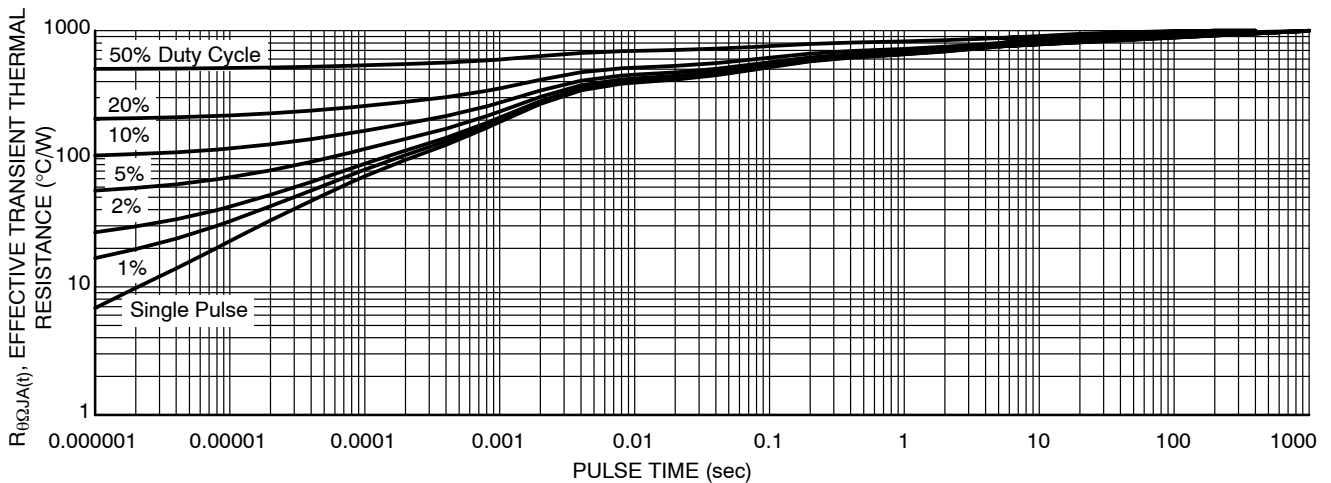

Figure 22. Thermal Response

MECHANICAL CASE OUTLINE

PACKAGE DIMENSIONS

ON Semiconductor®



SCALE 8:1

XLLGA6 0.90x0.65
CASE 713AC
ISSUE O

DATE 19 JUN 2014

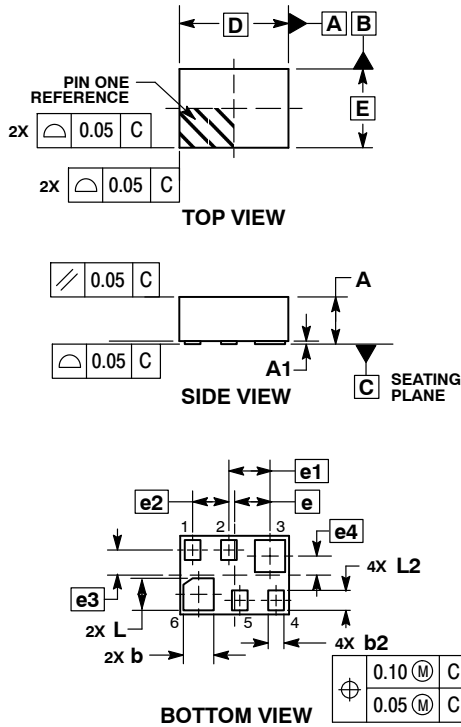

- NOTES:
1. DIMENSIONING AND TOLERANCING PER ASME Y14.5M, 1994 .
 2. CONTROLLING DIMENSION: MILLIMETERS.
 3. POSITIONAL TOLERANCE APPLIES TO ALL SIX LEADS.

MILLIMETERS		
DIM	MIN	MAX
A	0.340	0.440
A1	0.000	0.050
b	0.200	0.300
b2	0.080	0.180
D	0.900 BSC	
E	0.650 BSC	
e	0.295 BSC	
e1	0.340 BSC	
e2	0.300 BSC	
e3	0.208 BSC	
e4	0.158 BSC	
L	0.215	0.315
L2	0.115	0.215

GENERIC MARKING DIAGRAM*



- X = Specific Device Code
- M = Date Code

*This information is generic. Please refer to device data sheet for actual part marking. Pb-Free indicator, "G" or microdot "μ", may or may not be present.

RECOMMENDED SOLDERING FOOTPRINT*

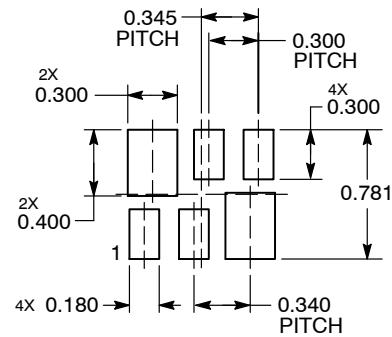

*For additional information on our Pb-Free strategy and soldering details, please download the ON Semiconductor Soldering and Mounting Techniques Reference Manual, SOLDERRM/D.

DOCUMENT NUMBER:	98AON86873F	Electronic versions are uncontrolled except when accessed directly from the Document Repository. Printed versions are uncontrolled except when stamped "CONTROLLED COPY" in red.
DESCRIPTION:	XLLGA6 0.90X0.65	PAGE 1 OF 1

ON Semiconductor and ON are trademarks of Semiconductor Components Industries, LLC dba ON Semiconductor or its subsidiaries in the United States and/or other countries. ON Semiconductor reserves the right to make changes without further notice to any products herein. ON Semiconductor makes no warranty, representation or guarantee regarding the suitability of its products for any particular purpose, nor does ON Semiconductor assume any liability arising out of the application or use of any product or circuit, and specifically disclaims any and all liability, including without limitation special, consequential or incidental damages. ON Semiconductor does not convey any license under its patent rights nor the rights of others.

onsemi, **Onsemi**, and other names, marks, and brands are registered and/or common law trademarks of Semiconductor Components Industries, LLC dba "**onsemi**" or its affiliates and/or subsidiaries in the United States and/or other countries. **onsemi** owns the rights to a number of patents, trademarks, copyrights, trade secrets, and other intellectual property. A listing of **onsemi**'s product/patent coverage may be accessed at www.onsemi.com/site/pdf/Patent-Marking.pdf. **onsemi** reserves the right to make changes at any time to any products or information herein, without notice. The information herein is provided "as-is" and **onsemi** makes no warranty, representation or guarantee regarding the accuracy of the information, product features, availability, functionality, or suitability of its products for any particular purpose, nor does **onsemi** assume any liability arising out of the application or use of any product or circuit, and specifically disclaims any and all liability, including without limitation special, consequential or incidental damages. Buyer is responsible for its products and applications using **onsemi** products, including compliance with all laws, regulations and safety requirements or standards, regardless of any support or applications information provided by **onsemi**. "Typical" parameters which may be provided in **onsemi** data sheets and/or specifications can and do vary in different applications and actual performance may vary over time. All operating parameters, including "Typicals" must be validated for each customer application by customer's technical experts. **onsemi** does not convey any license under any of its intellectual property rights nor the rights of others. **onsemi** products are not designed, intended, or authorized for use as a critical component in life support systems or any FDA Class 3 medical devices or medical devices with a same or similar classification in a foreign jurisdiction or any devices intended for implantation in the human body. Should Buyer purchase or use **onsemi** products for any such unintended or unauthorized application, Buyer shall indemnify and hold **onsemi** and its officers, employees, subsidiaries, affiliates, and distributors harmless against all claims, costs, damages, and expenses, and reasonable attorney fees arising out of, directly or indirectly, any claim of personal injury or death associated with such unintended or unauthorized use, even if such claim alleges that **onsemi** was negligent regarding the design or manufacture of the part. **onsemi** is an Equal Opportunity/Affirmative Action Employer. This literature is subject to all applicable copyright laws and is not for resale in any manner.

ADDITIONAL INFORMATION

TECHNICAL PUBLICATIONS:

Technical Library: www.onsemi.com/design/resources/technical-documentation
onsemi Website: www.onsemi.com

ONLINE SUPPORT: www.onsemi.com/support

For additional information, please contact your local Sales Representative at www.onsemi.com/support/sales