

**IMPORTANT**  
Read Before Using

**IMPORTANT**  
Lire avant usage

**IMPORTANTE**  
Leer antes de usar



**Operating / Safety Instructions**  
**Consignes d'utilisation/de sécurité**  
**Instrucciones de funcionamiento y seguridad**



**DIGILAB**  
**LC40 Laser Cutter**

**DREMEL®**

P.O. Box 081126 Racine, WI 53408-1126

Call Toll Free for Consumer Information & Service Locations

Pour obtenir des informations et les adresses de nos centres de service après-vente, appelez ce numéro gratuit  
Llame gratis para obtener información para el consumidor y ubicaciones de servicio

**1-844-4DRML3D (1-844-437-6533) [www.dremel.com](http://www.dremel.com)**





For English Version  
See page 2

Version française  
Voir page ??

Versión en español  
Ver la página ??

## Safety Symbols

The definitions below describe the level of severity for each signal word. Please read the manual and pay attention to these symbols.

	This is the safety alert symbol. It is used to alert you to potential personal injury hazards. Obey all safety messages that follow this symbol to avoid possible injury or death.
	DANGER indicates a hazardous situation which, if not avoided, will result in death or serious injury.
	WARNING indicates a hazardous situation which, if not avoided, could result in death or serious injury.
	CAUTION, used with the safety alert symbol, indicates a hazardous situation which, if not avoided, will result in minor or moderate injury.

## TABLE OF CONTENTS

<p>Safety .....2-7</p> <p>    Safety Symbols .....2</p> <p>    General Safety Warnings .....3-4</p> <p>    Laser Cutter Safety Warnings .....4-5</p> <p>    Additional Safety Warnings .....5</p> <p>    Symbols .....6</p> <p>FCC and IC Compliance .....7</p> <p>Information on Intellectual Property .....7</p> <p>Specifications .....8-9</p> <p>Material Usage .....10</p> <p>Resources .....11</p> <p>Glossary of Terms .....11-13</p> <p>Introduction .....13</p> <p>Tools &amp; Supplies Needed for Setup .....13</p> <p>Unpacking .....13</p> <p>Kit Contents .....14</p> <p>Getting to Know Your Laser Cutter .....16-18</p> <p>LCD Touch Screen .....19-38</p> <p>Laser Control Software .....39-44</p> <p>Setup .....45-60</p> <p>    Locate &amp; Cut Zip Ties .....45</p> <p>    Install Honeycomb Sheet .....46</p> <p>    Remove Camera Lens Cap .....46</p> <p>    Attach Water Tubes .....47</p> <p>    Attach Air Tube .....48</p>	<p>    Attach Hex Box™ Cord .....49</p> <p>    Attach Exhaust Shroud .....49</p> <p>    Exhaust Connection .....50-55</p> <p>    Attach Power Cord .....56</p> <p>    Test GFCI Unit .....56</p> <p>    Turn On the Laser Cutter .....57</p> <p>    Get Started .....57</p> <p>    Fill Hex Box™ with Distilled Water ...58</p> <p>    Connect a Computer to the     Laser Cutter .....59</p> <p>    Network Setups .....60-61</p> <p>Tests &amp; Alignments .....62-69</p> <p>    Mirror Alignment Overview .....62</p> <p>    Tools &amp; Supplies Needed for     Tests &amp; Alignments .....62</p> <p>    4 Corner Mirror Alignment Test ...63-64</p> <p>    Mirror Alignment Procedure .....65-69</p> <p>Tube Guard Removal .....70</p> <p>Operating the Laser Cutter .....71-81</p> <p>    Prohibited Uses &amp; Restrictions .....71</p> <p>    Create a Project .....72</p> <p>Maintenance .....82-84</p> <p>Shipping &amp; Storage .....85</p> <p>Serviceable Parts .....86</p> <p>Firmware and Open Source Software ...87</p> <p>Dremel Limited Warranty .....88</p>
---	--

## GENERAL SAFETY WARNINGS

**⚠ WARNING** Read all safety warnings, instructions, illustrations and specifications provided with this laser cutter. Failure to follow all instructions listed below may result in electric shock, fire and/or serious injury.

### READ ALL INSTRUCTIONS

#### SAVE ALL WARNINGS AND INSTRUCTIONS FOR FUTURE REFERENCE

##### Work Area Safety

**Keep work area clean and well lit.** Cluttered or dark areas invite accidents.

**Do not operate laser cutter in explosive atmospheres, such as in the presence of flammable liquids, gases or dust.** Laser beam may ignite the dust or fumes.

**Set up and operate the laser cutter in a well-ventilated area. Place laser cutter on flat nonflammable surface and away from flammable material. Provide at least 8 inches of unobstructed spacing around laser cutter to allow ventilation.** Laser cutters may create fumes that irritate eyes and airways. Obstructing airflow into or out of laser cutter may result in serious personal injury.

**Always use a properly configured, installed, maintained, and operating fume/smoke exhaust system as recommended by the manufacturer when operating the laser cutter.** Caustic fumes and smoke from the cutting and engraving process must be extracted from the laser system and exhausted outside or properly filtered to reduce the risk of personal injury.

**Always keep a properly maintained and inspected fire extinguisher in the area.** Typically, Carbon Dioxide (CO<sub>2</sub>) chemical fire extinguishers should be used.

**Laser cutters must be operated only by persons familiar with their operation and manufacturer's instructions.** Operation of laser cutters by persons unfamiliar with their operation and manufacturer's instructions can result in electric shock, fire and/or serious injury.

**Do not allow unsupervised children and bystanders to interact with the laser cutter while it is operating.** Persons unfamiliar with the operation of the laser cutter may change its setup, which may increase the risk of electric shock, fire and/or serious injury.

##### Electrical Safety

**Laser cutter plugs must match the outlet. Never modify the plug in any way. Do not use any adapter plugs with earthed (grounded) laser cutters.** Unmodified plugs

and matching outlets will reduce risk of electric shock.

**While operating the laser cutter, avoid body contact with earthed or grounded surfaces, such as pipes, radiators, ranges and refrigerators.** There is an increased risk of electric shock if your body is earthed or grounded.

**Do not expose laser cutters to rain or wet conditions.** Water entering a laser cutter may increase the risk of electric shock.

**Before every operation of a water-cooled laser cutter, make sure that the coolant connections and laser tube are leak-free.** Water leaks may increase the risk of electric shock.

**Do not abuse the cord. Never use the cord for carrying, pulling or unplugging the laser cutter. Keep cord away from heat, oil, sharp edges or moving parts.** Damaged or entangled cords increase the risk of electric shock.

**Do not operate laser cutters in damp locations.** Use of laser cutters in damp locations may increase the risk of electric shock.

##### Personal Safety

**Stay alert, watch what you are doing and use common sense when operating a laser cutter. Do not use a laser cutter while you are tired or under the influence of drugs, alcohol or medication.** A moment of inattention while operating laser cutters may result in serious personal injury.

**Use personal protective equipment. Always wear eye protection appropriate for class of laser engraver.** Protective equipment such as heat and cut resistant gloves used when work pieces are hot or have sharp edges will reduce personal injuries.

**Dress properly. Do not wear loose clothing or jewelry. Keep your hair, clothing and gloves away from moving parts.** Loose clothes, jewellery or long hair can be caught in moving parts.

**Be careful removing work pieces from the laser cutter. Cutting with a laser increases**

## GENERAL SAFETY WARNINGS

**the temperature of the work piece and the temperature of the work piece may remain high after laser cutter stops operating.** Touching hot work pieces before they cool down may result in burns.

**Do not let familiarity gained from frequent use of laser cutters allow you to become complacent and ignore laser cutter safety principles.** A careless action can cause severe injury within a fraction of a second.

### Laser Cutter Use and Care

**Prevent idle laser cutter from being used by children and do not allow persons unfamiliar with the laser cutter or these instructions to operate the laser cutter.** Laser cutters can be dangerous in the hands of untrained users.

**Maintain laser cutters. Check for misalignment or binding of moving parts,**

**breakage of parts and any other condition that may affect the laser cutter's operation. If damaged, have the laser cutter repaired before use.** A poorly maintained laser engraver may result in a risk of shock, fire and/or serious injury.

**Use the laser engraver in accordance with these instructions, taking into account the working conditions and the work to be performed.** Use of the laser engraver for operations different from those intended could result in a hazardous situation.

### Service

**Have your laser cutter serviced by a qualified repair person using only identical replacement parts.** This will ensure that the safety of the laser cutter is maintained.

## LASER CUTTER SAFETY WARNINGS

**⚠ WARNING** Never expose yourself to the laser beam since it may cause physical burns and can cause severe eye damage. Proper use and care of this laser cutter system are essential to safe operation.

**Never operate the laser cutter system without constant supervision of the cutting and engraving process.** Exposure to the laser beam may cause ignition of combustible materials and start a fire.

**Never use PVC or other nonconductive duct materials for the exhaust system.** Static charges may build up and may cause a risk of fire or explosion.

**Always use fire rated rigid or flexible metal or metalized ducting in the exhaust system.** Non-fire rated exhaust ducting may increase the risk of fire.

**Always inspect the exhaust fan and duct work for obstructions and ensure proper air flow exists before each use.** Unobstructed and properly maintained exhaust fan and duct work will reduce the risk of fire and effectively extract caustic fumes and smoke.

**Never engrave or cut any unknown material. Only engrave materials recommended by the manufacturer. The vaporization/melting of many materials, including but not limited to PVC and polycarbonates, can give off hazardous fumes.** Always refer to the Safety Data Sheet (SDS) from the material manufacturer to determine the response of any work material to extreme heat (burning/fire hazard) to prevent hazards.

**Always use the air assist as recommended by the manufacturer, especially while cutting. Cutting movements are relatively slow and apply an extremely large amount of heat to the work piece.** Avoid the build-up of heat in order to reduce the risk of fire.

**Keep the interior of the laser cutter, including the table tray, clean and free of debris. Clean the laser.** A build-up of cutting and engraving residue and debris is dangerous and may increase the risk of fire.

**Never look into the beam of the alignment laser.** Eye injury can result.



## LASER CUTTER SAFETY WARNINGS

**Never operate the alignment laser without the focus lens or other optical elements of laser cutter in place.** The unfocused beam may be reflected out of the chassis and increase the risk of eye injury.

**Do not operate the laser machine with any of the panels removed. Remember that the laser beam is invisible!** Exposure of the laser beam will greatly increase the risk of injury and/or fire.

**Before using the laser machine, test the ground fault circuit interrupter (GFCI) provided with the supply cord to insure it is operating correctly.** A properly operating GFCI reduces the risk of electrical shock.

**Do not attempt to modify or defeat the safety interlock system for any reason.** This could result in exposure to hazardous laser radiation.

**Do not use laser cutter with extension cords.** The GFCI on the machine power cord will not prevent electrical shock from the extension cords.

**Always use provided work piece support structure.** Fabrication without honeycomb support may lead to fire or release of stray radiation.

**Do not use irregularly shaped work piece.** Risk of stray radiation or fire.

**Do not stack work pieces.** Stacking work pieces increases the risk of fire.

**Use only recommended accessories.** Follow instructions that accompany accessories. Use of improper accessories may cause hazards

**Ensure tools and parts such as spacer puck, wrench, debris, etc. are removed from the honeycomb plate before starting a laser job.** Objects or debris may interfere with the laser head and lead to stray radiation or risk of fire.

**Do Not Block exhaust fan.** VOCs created by the laser engraver process must be properly vented to help prevent personal injury.

**This product is provided with a ground fault circuit interrupter (GFCI) built into the power cord plug.** If replacement of the plug or cord is needed, use only identical replacement parts.

**Do not try to clean exhaust ducting.** The high concentration of particles may become airborne and create inhalation exposure.

**Do not spill water on the Hex Box™ unit.** Damage to electronics may occur.

## ADDITIONAL SAFETY WARNINGS

**⚠ CAUTION** Use of controls or adjustments or performance of procedures other than those specified herein may result in hazardous radiation exposure.

**⚠ CAUTION** Do not tap or scratch LCD screen with sharp objects. The LCD screen may become damaged.

**⚠ CAUTION** Do not move the laser head by hand when locked. Moving a locked laser head by hand may result in damage to the gantry system.







**⚠ CAUTION** Use care when removing the tube guard. The LED lights may be damaged by contact with tube guard edges.

**⚠ CAUTION** Never remove the mirrors for cleaning! Take extra caution to not move the orientation of the mirrors as this will affect laser beam alignment and would require time intensive laser beam realignment.

**SAVE ALL WARNINGS AND INSTRUCTIONS FOR FUTURE REFERENCE.**

## SYMBOLS

**IMPORTANT:** Some of the following symbols may be used on your LC40. Please study them and learn their meaning. Proper interpretation of these symbols will allow you to operate the tool better and safer.

Symbol	Designation / Explanation
V	Volts (voltage)
A	Amperes (current)
Hz	Hertz (frequency, cycles per second)
∅	Diameter
~	Alternating current (type or a characteristic of current)
	Alerts user to read manual
	Earthing terminal (grounding terminal)
	Warns of laser radiation. Avoid direct eye exposure. Class 3R laser product.
	Warns of high voltage. Contact with high voltage can cause death or serious injury.
	This fire warning icon calls attention to fire risks that are present while operating the laser.
	This symbol designates that this tool is listed by Underwriters Laboratories, to United States and Canadian Standards.

# FCC AND IC COMPLIANCE

## FCC COMPLIANCE

NOTE: This equipment has been tested and found to comply with the limits for a Class B digital device, pursuant to Part 15 of the FCC Rules. These limits are designed to provide reasonable protection against harmful interference in a residential installation. This equipment generates, uses, and can radiate radio frequency energy and, if not installed and used in accordance with the instructions, may cause harmful interference to radio communications. However, there is no guarantee that interference will not occur in a particular installation. If this equipment does cause harmful interference to radio or television reception, which can be determined by turning the equipment off and on, the user is encouraged to try to correct the interference by one or more of the following measures:

- Reorient or relocate the receiving antenna.
- Increase the separation between the equipment and receiver.
- Connect the equipment into an outlet on

a circuit different from that to which the receiver is connected.

- Consult the dealer or an experienced radio/TV technician for help.

Changes and Modifications not expressly approved by the manufacturer or registrant of this equipment can void your authority to operate this equipment under Federal Communications Commission's rules.

## INDUSTRY CANADA (IC)

This device complies with Industry Canada's licence-exempt RSSs. Operation is subject to the following two conditions:

- (1) This device may not cause interference; and
- (2) This device must accept any interference, including interference that may cause undesired operation of the device.

The device meets the exemption from the routine evaluation limits in section 2.5 of RSS 102 and compliance with RSS-102 RF exposure, users can obtain Canadian information on RF exposure and compliance.

# INFORMATION ON INTELLECTUAL PROPERTY

The Dremel LC40 is intended for laser cutting/engraving materials to create objects using digital files and digital designs that you create or own, or have the right to use when you operate the Dremel LC40. When cutting/engraving materials to create objects using the Dremel LC40, it is your responsibility to ensure that you do not infringe any third party intellectual property rights or violate any applicable laws or regulations, such as U.S. or foreign intellectual property laws.

The Dremel LC40 may not be used to create objects using digital files or digital designs protected by intellectual property rights owned by third parties without such third parties' permission to use such digital files or digital designs for the creation of such objects. Using the Dremel LC40 to do any of the following, which are provided to you as examples and must not be viewed as an exhaustive list, may require the permission of third parties: to create a duplicate or

facsimile (in whole or in part) of any digital design not owned by you, to create an object from a digital file you do not own, or to make an object from a scan of a physical object that you did not create. It is your responsibility to obtain such permission. In some cases, you may not be able to obtain such permission. Where such permission cannot be obtained, you must not create such objects. You must not modify, reverse engineer, decompile, or disassemble the Dremel LC40, except as permitted by applicable law.

If you use the Dremel LC40 in any way other than as recommended and described in these Operating/Safety Instructions, you do so at your own risk. Using the Dremel LC40 to make objects that infringe any intellectual property rights owned by third parties could result in civil or criminal prosecution and penalties, and you could be liable for money damages, fines, or imprisonment.

# SPECIFICATIONS

## LASER SYSTEM

Laser Type: Sealed CO2 Laser Tube  
Laser Power: 40W  
Laser Classification: IEC 60825-1 Class 3R  
Beam Size: 6.5 mm diameter @ 1.2 m  
Working Current: 20mA  
Wavelength: 10.6 µm

## LASER CUTTER WEIGHT & DIMENSIONS

Dimensions: 32" x 20" x 8.25"  
(812.5 mm x 508 mm x 209.55 mm)  
Weight: 63.3 lbs (28.7 kg) (without Hex Box™ or accessories)  
Shipping Weight: 100 lbs (45 kg)

## HEX BOX™ WEIGHT & DIMENSIONS

Dimensions: 7.25" x 11" x 7.25"  
(184 mm x 279 mm x 184 mm)  
Weight: 10 lbs (4.5 kg)  
Total Water Capacity: 35 oz (1 liter)

## ELECTRICAL REQUIREMENTS

LC40 input rating: 120V, 60Hz, 6 A  
Hex Box™ rating: 12V DC, 4.7 A

## OPERATING ENVIRONMENT

Recommended Environmental Temperature: 60-85F (16-29C)  
Sturdy, flat, and level workspace that holds weight of the Laser, material, and Hex Box™.  
For indoor use only.

## SUPPORTED OPERATING SYSTEM AND SYSTEM SPECIFICATIONS

Compatibility: Mac & PC  
•Apple® Mac® OS® X v10.9 or later (Mavericks)  
•Microsoft® Windows® 10  
•Microsoft® Windows® 8.1  
•Microsoft® Windows® 7 SP1  
Browser Compatibility: Chrome, Safari, Firefox, & IE  
Min Screen Resolution: 1024 x 768 Pixels  
Ability to Connect Through Network (Ethernet or Wireless) without Internet Connection  
Wireless connection frequency: 2.4 GHz

## OPERATING CAPACITIES

Engraving Area: 18.4" x 12"  
(467 mm x 304.8 mm)  
Cutting Area: 20" x 12"  
(508 mm x 304.8 mm)  
Max Engraving Height: 1.25" (32 mm)  
Max Cutting Height: ¼" Wood and Acrylic (6 mm)

# SPECIFICATIONS

## LASER CUTTER & HEX BOX™ CLEARANCE REQUIREMENTS

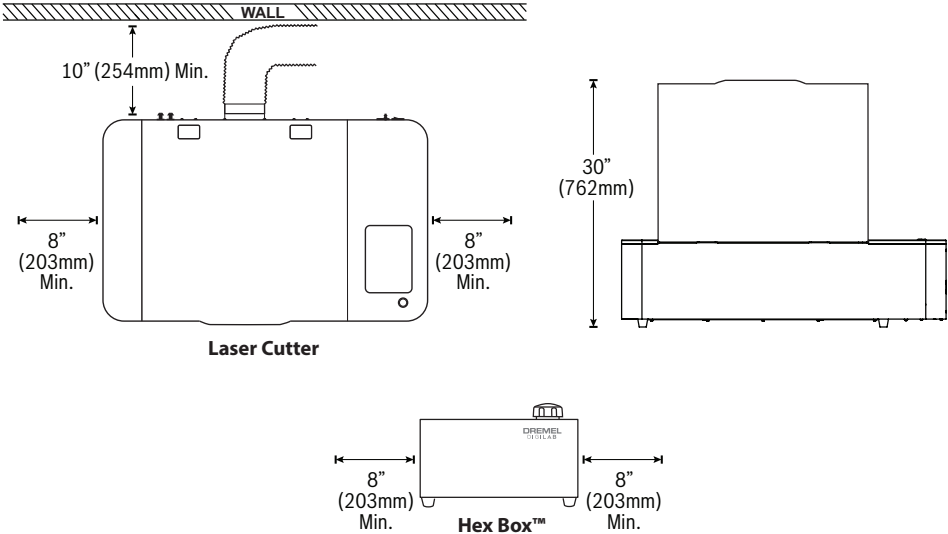

## MATERIAL USAGE

**Table 1 LC40 Commonly Used Materials**

Acrylic <sup>†</sup>	Denim fabric	Oak, solid
Aluminum, anodized	Felt (wool)	Paper
Plywood* <sup>†</sup>	Glass	Rubber, laser grade
Cork	Leather, unstained	Walnut, solid
Cardboard	Maple, solid	
Cotton fabric	Mat board	

\* Must be California 93120 Phase 2 & TSCA Title VI compliant for formaldehyde

<sup>†</sup>Birch Plywood and Acrylic are available from Dremel.

**Table 2 LC40 Prohibited Materials**

ABS	Nylon
Beryllium oxide	Painted material, varnished materials
Carbon	Particleboard, paneling
Chlorinated plastics	Polycarbonate
Coated carbon fiber	Polychloroprene (CR or chloroprene rubber, marketed under the brand name of Neoprene)
Coated materials	Polypropylene foam, Polypropylene sheet
Epoxy based or phenolic resins	Polystyrene foam
Fiberglass	Polyurethane, Polyurethane foam
Fluorine based plastics: PTFE (Teflon)	Polyvinyl chloride (PVC) Found in many common products such as but not limited to; flooring, siding, piping, roofing membranes, credit cards, toys, flexible tubing.
Fluorinated ethylene propylene (FEP)	POM Delrin/acetyl.
Galvanized metal	Rubber
HDPE (High Density Poly Ethylene)	Styrofoam
Leather, Artificial or Treated	Wood that has been:
Materials containing:	• Coated
• Astatine	• Fumigated
• Bromine	• Pressure treated
• Chlorine	• Stained
• Fluorine	
• Formaldehyde (including wood)	
• Flame-retardants	
• Halogens	
• Iodine	
Mirrored surfaces	

While the LC40 can cut and etch a variety of materials, some materials such as most metals, cannot be marked and will give less than desirable results. Other materials may not have acceptable finish quality.

## RESOURCES

Resource	Description	Location
Quick Start Guide	Provides an illustrated walkthrough of how to un-box the laser cutter and start a job.	Printed version is located in the box with the laser cutter. It is also available on <a href="http://digilab.dremel.com/support/laser-support">digilab.dremel.com/support/laser-support</a>
Laser Cutter LCD Interface	Provides step-by-step instructions for setting up the laser cutter. Also allows control of the laser head, run recent jobs, and adjust machine settings.	On the laser cutter machine
Dremel LC40 Control Software	Provides the interface for setting up, saving, and sending cutting and engraving jobs to the laser cutter.	Enter the IP address of the laser cutter into the browser.
Dremel Website	Access project inspiration and downloads, Dremel product information, and customer support.	<a href="http://dremel.com">dremel.com</a>
DigiLab Website	Access information about Dremel DigiLab products, education projects, and more.	<a href="http://digilab.dremel.com">digilab.dremel.com</a>
Dremel Customer Support	Contact Dremel for product support, maintenance, and service.	1-844-437-6533 <a href="http://dremel.com/digilab-support">dremel.com/digilab-support</a>

## GLOSSARY OF TERMS

Term	Definition
Air Assist	Air delivery system that helps to control flareups. Air is supplied by the Hex Box™.
Alignment Laser	An additional laser diode whose beam results in a red dot that is used to help align the mirrors.
Auto Array	A software function that creates a grid of the desired size by repeating the selected image.
.bin File	A binary file format used to save and load workspace projects to and from a computer.
Cut	Also called "vector", used for cutting through work piece. This function requires a vector, or line file to execute.
Design Software	Graphics editing software used to create and manipulate images for laser cutting and engraving.

## GLOSSARY OF TERMS

Engrave/Etch	Function, also called "raster", used to darken or remove the surface of a material, rather than cut through it. This function requires an image file to execute.
Exhaust Hose	Duct that is connected to the laser cutter unit to vent byproducts outside or into a filtration unit or to outside ventilation.
Exhaust Shroud	A metal tubing connection that is screwed onto the rear of the laser cutter unit over the exhaust vent fan.
Exhaust Port	An opening on the rear of the laser unit that allows the vent fan to draw air out of the workspace.
Firmware	Software that is embedded on the computer hardware of the laser cutter and controls its operation. Updates to the firmware will be provided by Dremel and applied to the laser cutter directly over the internet.
Greyscale	Also called "dither", takes a black and white image and assigns different densities of dots to visually create a number of different shades of grey. Darker areas of the image will have more dots, while lighter areas will have less dots.
Hex Box™	A separate and interconnected part of the laser cutter system that integrates the water circulation and air assist functions of the laser cutter.
Honeycomb Plate	An aluminum tray that rests on the bed and supports the work piece as it is cut and engraved.
Job	A project that is sent to the laser for fabrication.
Laser Head	An assembly of components, including a mirror, lens, and cone, which the laser passes through before making contact with the material.
LC40 Control Software	The laser control software that is provided on the machine and accessed by a computer through the network connection.
Laser Tube	A glass tube located at the rear of the laser unit that generates the laser beam.
Lens	A glass lens in the laser head that focuses the beam of the laser for optimal cutting and engraving.
Material	The substance of which the work piece or work is composed.
Material Library	A listing of materials for which suggested laser settings are predefined in the Dremel LC40 Control Software.
Mirrors	A set of mirrors that direct the laser beam of the laser from the tube to the work piece.
Project	A planned piece of work created in the Dremel LC40 Control Software which can be sent to the laser engraver as a job.
Raster	Digital art composed of horizontal and vertical rows of pixels.
Score	Function used to make a mark on the surface of the material when you want to emphasize the outline of text or an object
Spacer Puck	A small cylinder that is placed between the work piece and laser head to assist in focusing the laser.



## GLOSSARY OF TERMS

Touch Screen	Touch activated full color display.
Vector Art	Art created using vector illustration software programs, such as Adobe Illustrator® or Corel Draw®.
Vent Fan	A fan located in the exhaust port that helps draw air out of the workspace.
Work piece	Also called "work" or "material". It is the object to be cut or engraved with the laser.
Workspace	a) The area inside of the laser unit that is open for work piece placement and the movement of the laser head. b) A screen in the Dremel LC40 Control Software where a job is created. It provides a graphical representation of the intended job and its position relative to the general boundaries of the laser working area.
X-Axis Guide Rails	A set of rails at the rear of the laser bed that allow movement of the laser head to the left or right side of the workspace.
Y-Axis Guide Rails	A set of rails on either side of the laser bed that allow movement of the laser head to the front or rear of the workspace.

## INTRODUCTION

Welcome to the world of Dremel Digilab. Our mission is to mentor you through the digital fabrication process and share best practices for bringing your ideas to life.

Laser cutting and engraving are processes that will invoke experimentation and persistence. Thankfully, the Dremel experts are here to make your job easier with online tips, documentation, and live support. The Dremel Laser Cutter brings robust functionality such as network connectivity, recommended settings for

commonly used materials, and multi-sensor checks. To get started with the Laser Cutter follow the initial setup routine on the touch screen to guide you through the hardware and software setup of the machine.

You can register your Laser Cutter and create a user profile by going to [dremel.com/support/product-registration](http://dremel.com/support/product-registration). Your profile gives you access to a variety of laser projects and support. Once setup and registration is complete, you are ready to start making.

## TOOLS & SUPPLIES NEEDED FOR SETUP



Distilled Water

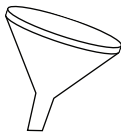

Funnel

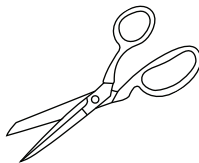

Scissors

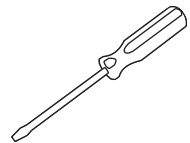

Screwdriver

## UNPACKING

**⚠ WARNING** **Two person lift required.** Lifting the laser cutter alone may result in personal injury.

**Create a workstation.** Prepare a flat, sturdy table or workbench that can support the weight of the Laser and Hex Box™. The workstation should be close to an electrical outlet and allow for necessary ventilation described in the SETUP section "Exhaust Connections" page xx.

### Open the top of the box.

1. Remove Reusable Tote Bag from packaging and pull out box 1. Open lid to reveal the project sample material and the Honeycomb Plate.
2. Remove Instructional Manual, Water Hoses, Air Tube, Screws, Hex Box™ Cap, Hex Key Wrench, Spacer Puck from box 2.
3. Remove foam to reveal the Laser Cutter. Use two people to lift Laser Cutter out of box by straps and place on workstation. After the Laser Cutter has been taken out of the box, hook straps to the Reusable Tote Bag. **DO NOT CUT STRAPS.**

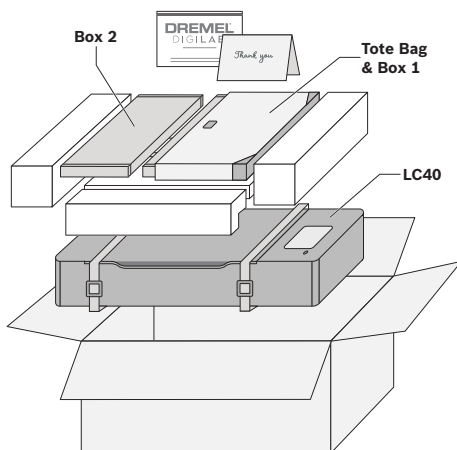

4. Open the lid of the Laser Cutter to reveal box 3 with Hex Box™, Exhaust Duct, and Exhaust Shroud.

**Note:** Save the Dremel DigiLab Laser Cutter packaging for future transport and storage.

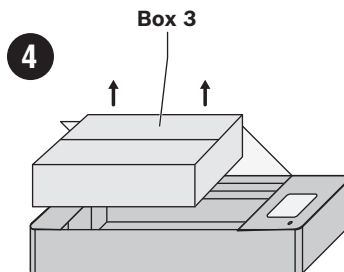
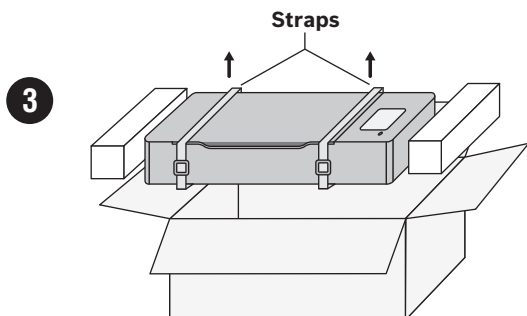
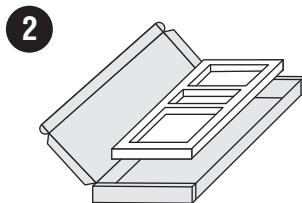
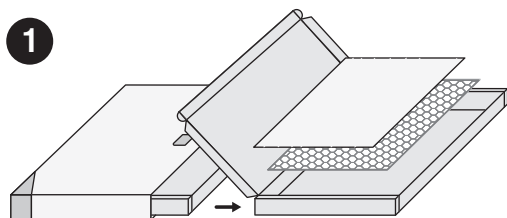

## KIT CONTENTS

The LC40 laser cutter is shipped with the following included parts and accessories:

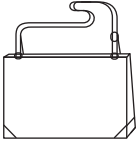

Reusable Tote Bag

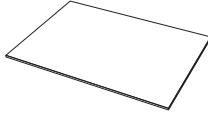

Project Sample Material

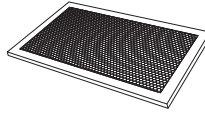

Honeycomb Plate



Quick Start Guide



Operating/Safety Instructions



Ethernet Cable

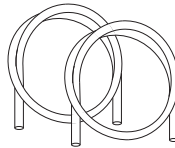

Water Hose  
(1 blue & 1 clear)

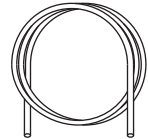

Air Tube  
(black)



(2) Hose Clamps



Hex Box™  
Connector Cord

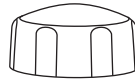

Hex Box™  
Water Tank Cap

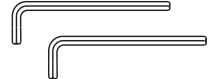

Hex Keys



Lens Cleaning Wipes

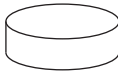

Spacer Puck



Alignment Paper

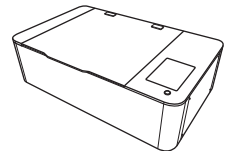

Laser Cutter

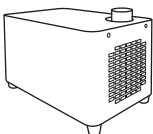

Hex Box™

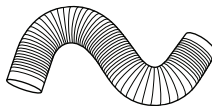

Exhaust Hose

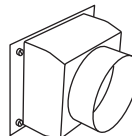

Exhaust Shroud

# GETTING TO KNOW YOUR LASER CUTTER

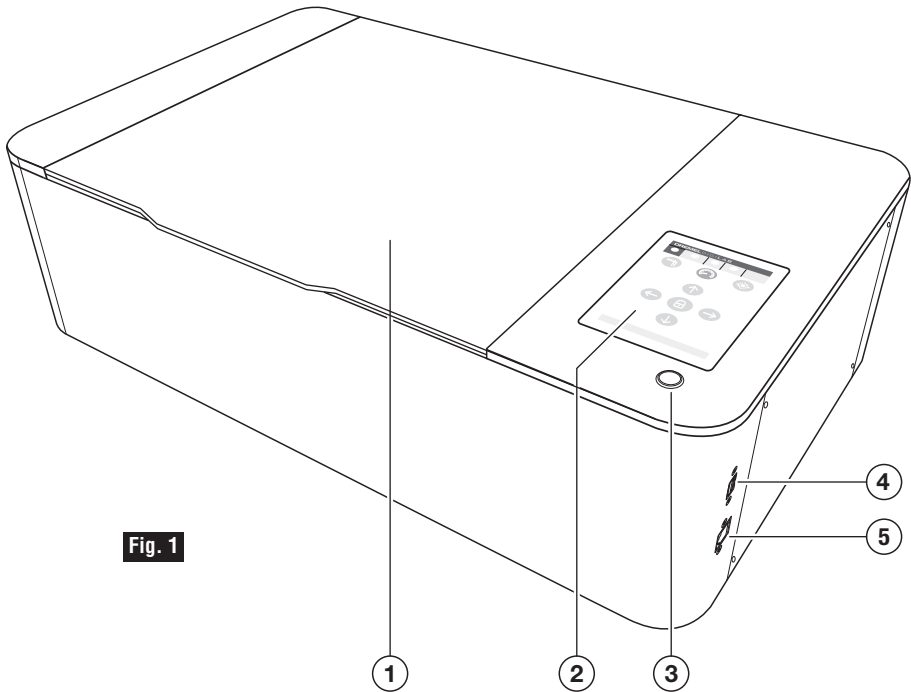

**Fig. 1**

## **LC40 Laser Cutter**

---

- 1.** Lid
- 2.** Touchscreen
- 3.** Start Button
- 4.** USB Port (for service only)
- 5.** Ethernet Port
- 6.** LED Lights
- 7.** Laser Tube Shroud
- 8.** Honeycomb Plate
- 9.** Gantry
- 10.** Mirror 1
- 11.** Beam Combiner Lens
- 12.** Mirror 2
- 13.** Laser Head
  - a.** Mirror 3
  - b.** Focus Lens
  - c.** Air Nozzle
  - d.** Laserhead Knob
  - e.** Wide Angle Camera

- 14.** Power Switch
- 15.** Power Cord
- 16.** Hex Box™ Power Outlet
- 17.** Air Inlet
- 18.** Exhaust Shroud
- 19.** Water Outlet
- 20.** Water Inlet

## **Hex Box™**

---

- 21.** Water Tank Cap
- 22.** Water Tank
- 23.** Power Inlet
- 24.** Air Outlet
- 25.** Water Outlet
- 26.** Water Inlet

# GETTING TO KNOW YOUR LASER CUTTER

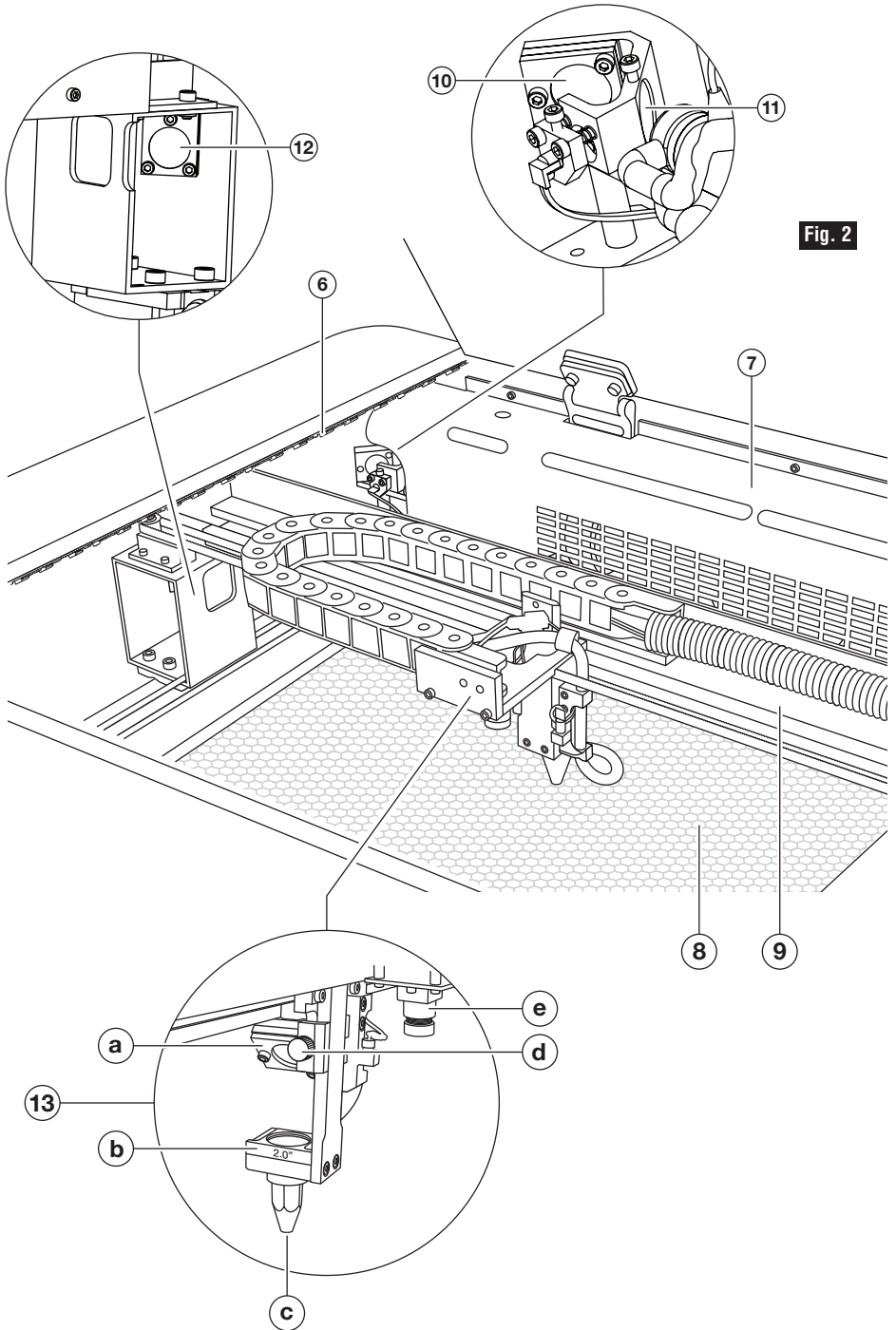

# GETTING TO KNOW YOUR LASER CUTTER

## REAR VIEW OF LASER CUTTER

Fig. 3

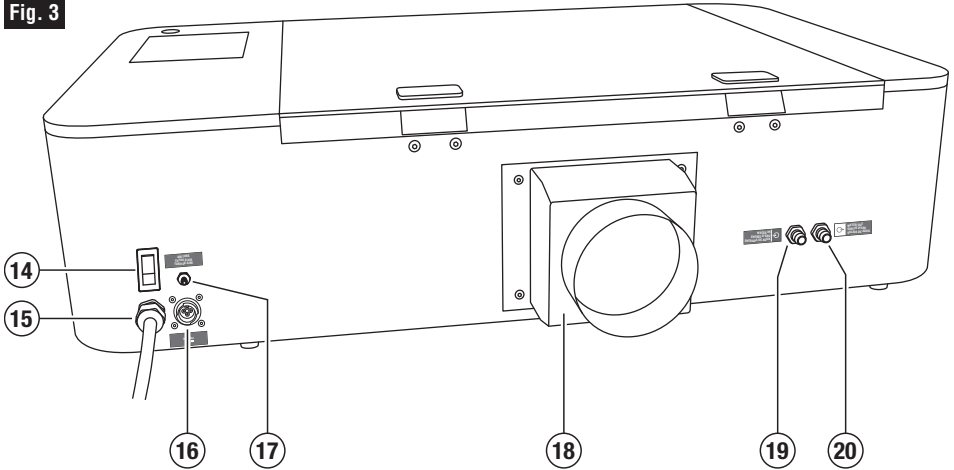

## REAR VIEW OF HEX BOX™

Fig. 4

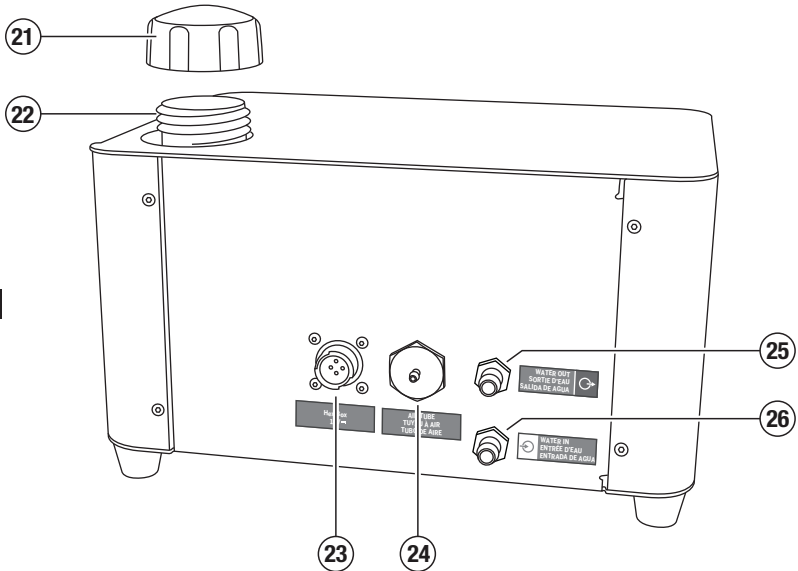

## LCD TOUCH SCREEN

**⚠ WARNING** Observe all provided warnings and safety instructions when using the Dremel LC40. Failure to do so may result in fire, equipment damage, property damage or personal injury.

**⚠ CAUTION** Do not tap or scratch LCD screen with sharp objects. The LCD screen may become damaged.

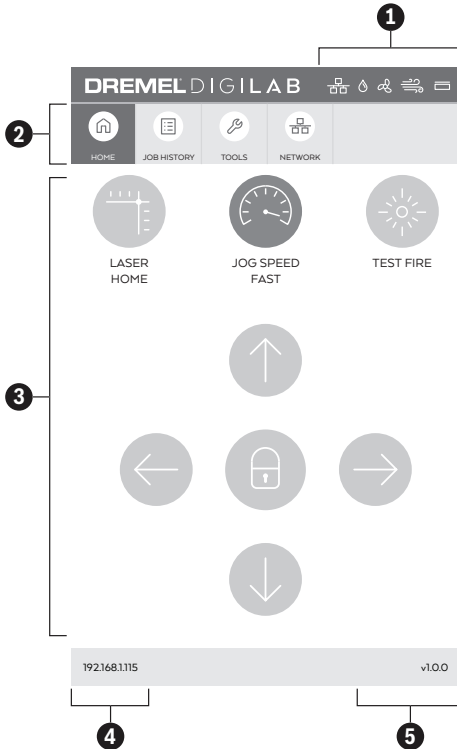







The LC40 touch screen allows control of the basic functions of the laser without the need to connect to a computer.

- 1 Status Bar** – Displays information about selected conditions of the LC40.
- 2 Menu Bar** – Displays the icons and names of the Touch Screen menus.
- 3 Control Interface** – Information or additional action pertaining to selected menu item.
- 4 IP Address** – A unique number used to connect the Laser Cutter over a network to a web browser.
- 5 Firmware Version** – Displays the currently installed firmware version.

# LCD TOUCH SCREEN

## 1 Status Bar

Status Icon	Name	What it means
	Ethernet	LC40 is connected to a computer or a network router via Ethernet Port. The icon will disappear when there is no Ethernet connection.
	Wireless	LC40 is connected to a computer or network router via wireless. The icon will disappear either when there is no wireless connection or when the Ethernet icon is active. When LC40 is connected with both Ethernet and Wireless, only the Ethernet icon will display.
	Water Cooling	WHITE: Cooling system functioning normally. RED: Cooling system needs attention.
	Vent Fan	WHITE: Vent fan functioning normally. RED: Vent fan needs attention.
	Air Assist	WHITE: Air assist functioning normally. RED: Air assist needs attention.
	Lid	WHITE: Lid is closed. RED: Lid is open.

Note: Water Cooling, Vent Fan and Air Assist icons will only update in real time. (When the Hex Box is activated by the LC40).

## 2 Menu Bar

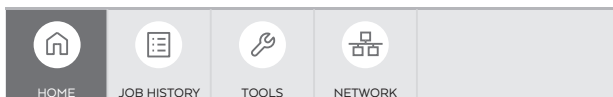

**HOME** – Access to laser head position controls and to test fire the laser.

**JOB HISTORY** – Lists previously run jobs and provides option to re-run them.

**TOOLS** – Information about the unit and settings.

**NETWORK** – Information and access to network connection settings.

When necessary, the LCD touch screens will offer options to return to the previous screen or advance to the next screen.

 Tap to return to previous screen.

 Tap to proceed to the next screen.



# LCD TOUCH SCREEN

## HOME > UNLOCKED

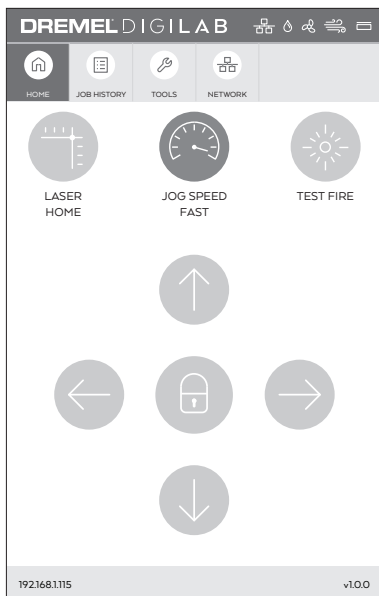

**LASER HOME** – Moves the laser head back to its origin location. Button will flash when homing is necessary.



**JOG SPEED** – Toggles between fast and slow laser head movement speed. Fast is default speed.



**TEST FIRE** – Enable the laser to fire for a short period to identify its location relative to the material.



### Directional Arrows

Moves the laser head in direction of arrow.



### Laser Head Locked (default)

**CAUTION** Do not move the laser head by hand when locked. Moving a locked laser head by hand may result in damage to the gantry system.

A closed lock icon indicates that the laser head is locked and can only be moved using the directional arrow buttons.

Pressing the lock button toggles between locked or unlocked laser head setting.

# LCD TOUCH SCREEN

## HOME > LOCKED

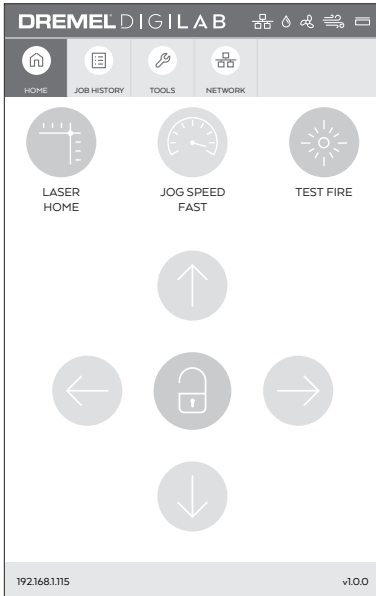

### Laser Head Unlocked

An open lock icon indicates that the laser head can be moved by hand.

Note: When Laser Head is unlocked the Directional Arrows and Speed virtual buttons are nonfunctional.

## JOB HISTORY

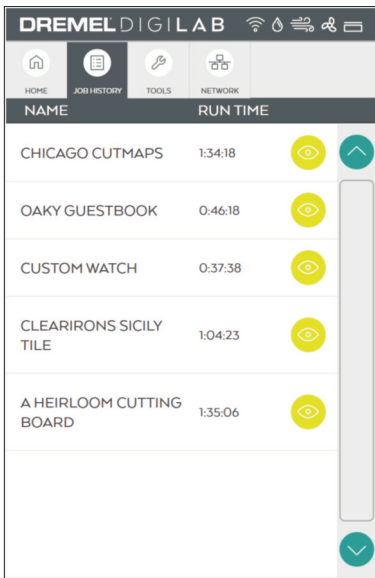

This tab displays jobs received by the laser cutter.

As received from the factory, this list is empty. The Factory Reset option will clear Job History. Job creation is explained in the Software Section.

Once a job is sent from the software to the laser, it will appear in the job history tab.

**NAME** – the name of project job(s) within the Job History list.

**RUN TIME** – required time to complete project.



Tap to preview the job and open the sub-menu for the job.

# LCD TOUCH SCREEN

## JOB HISTORY

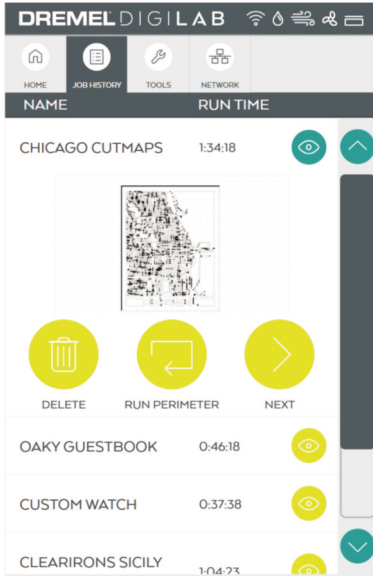

This screen displays options for the Job selected from the list.

 **DELETE** – Delete files from the Job History list.

 **RUN PERIMETER** – Executes the run perimeter.

 **NEXT** – Changes the text to LOADING. The Job will prepare to start.

Note: If a job is rerun, the system safety checklist will appear (see page XX Operation Screens).

# LCD TOUCH SCREEN

## TOOLS > MENU SCREEN

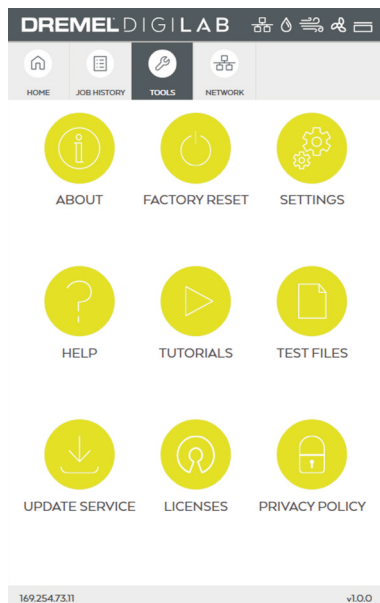

This screen displays available tools for management of the laser cutter.



**ABOUT** – Displays laser cutter information such as model number, serial number, firmware version, usage, and network information.



**FACTORY RESET** – Remove all information stored on LC40 and return it to factory defaults.



**SETTINGS** – Shows language and display settings.



**HELP** - Displays service menu with customer service contact information.



**TUTORIALS** – Displays short tutorials on operation of the laser.



**TEST FILES** – Displays and allows execution of test files to verify proper operation of the laser.



**UPDATE SERVICE** – Displays available service updates from Dremel. Updates are pushed to the unit and cannot be requested. The user has the option to accept or ignore the update.



**LICENSES** – Displays the lists of OPEN SOURCE software licenses associated with the unit.



**PRIVACY POLICY** – Displays a website address for further details on Dremel privacy policy.

## LCD TOUCH SCREEN

### TOOLS > ABOUT THIS DEVICE

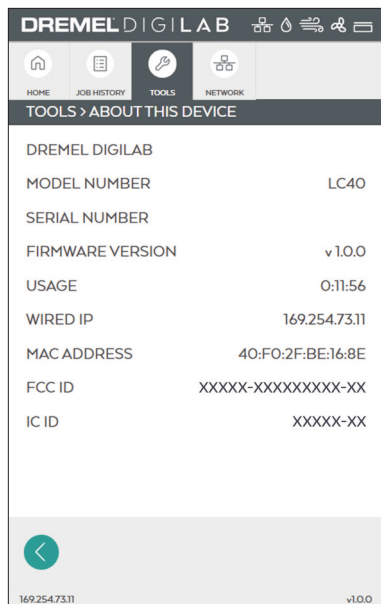

This screen displays laser cutter hardware and software information.

**MODEL NUMBER** – Displays unit model number.

**SERIAL NUMBER** – Displays unit serial number.

**FIRMWARE NUMBER** – Displays the currently installed firmware version.

**USAGE** – Displays total hours of time that jobs have been run.

**WIRED IP** – Displays Ethernet IP address, if connected.

**WIRELESS IP** – Displays IP address assigned by wireless router.

**MAC ADDRESS** – Displays unique identifier assigned to a network interface controller.

**FCC ID** – Displays FCC ID

**IC ID** – Displays IC ID

### TOOLS > FACTORY RESET

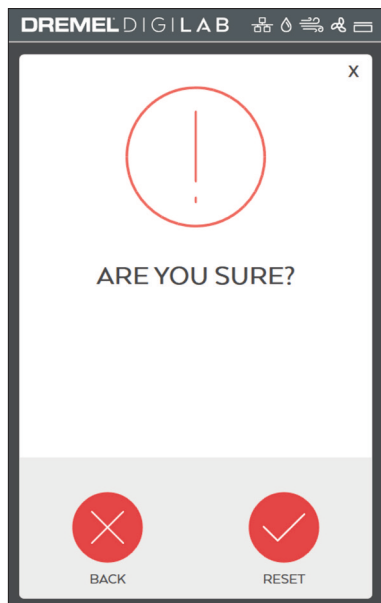

This screen allows for verification of factory reset selection.

 **BACK** – Tap to cancel factory reset and return to Tools > Menu Screen.

 **RESET** – Tap to perform factory reset.

**NOTE** - The following actions occur when Factory Reset is performed:



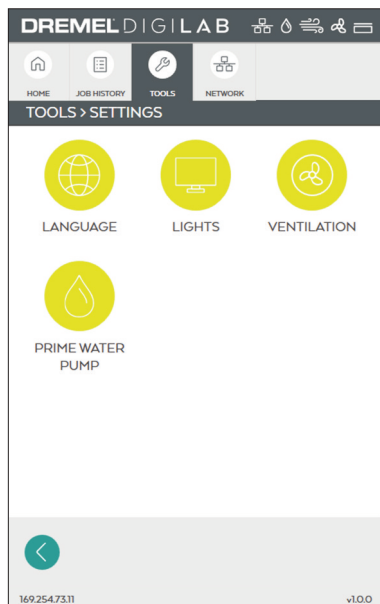

- EULA screen will appear on next power up and needs to be accepted.
- Country and Language selection will appear on next power cycle.
- Job history on the LCD software Interface will be cleared.
- Default material settings will be restored for the Laser browser interface software.
- User custom material settings will be cleared.
- Network configuration will be restored to default with all custom settings cleared.
- Saved wireless network and password will be cleared.
- Ventilation setting will revert back to default of EXTERNAL FILTRATION/VENTILATION SYSTEM.

# LCD TOUCH SCREEN

## TOOLS > SETTINGS



This screen displays available settings

-  **LANGUAGE** – Displays a sub-menu where LCD menu warnings language can be selected.
-  **LIGHTS** – Displays a sub-menu where cabinet LED lights can be turned “ON” and “OFF”.
-  **VENTILATION** – Displays a sub-menu screen where ventilation type can be selected.
-  **PRIME WATER PUMP** – Displays a sub-menu with water pump controls.

## TOOLS > SETTINGS > LANGUAGE

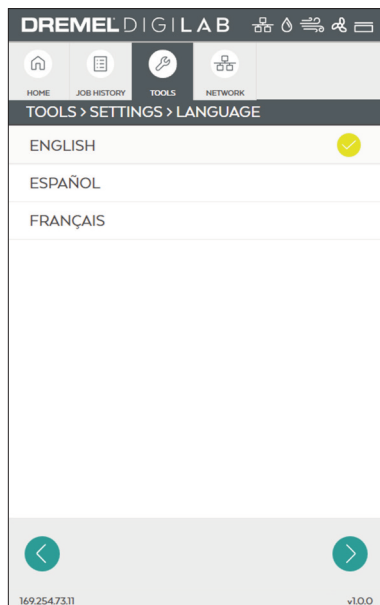

This screen displays and allows selection of different languages.

Note: Choosing the language on this screen does not set the software language on the computer, only the LCD warning screens are affected.

## LCD TOUCH SCREEN

### TOOLS > SETTINGS > LIGHTS

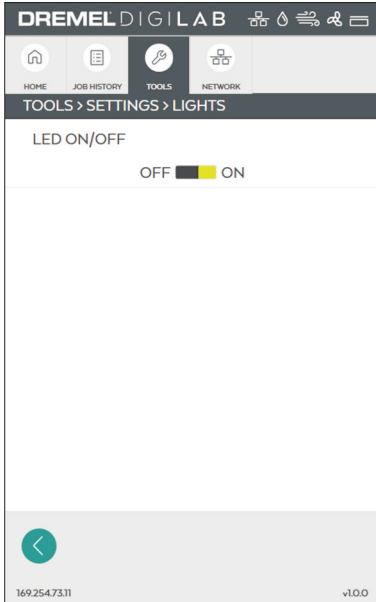

This screen displays the option to turn ON or OFF the LED lights that illuminate the workspace.

**LED ON/OFF** – Turns “ON” and “OFF” LED lights. LED lights are “ON” by default. If the main power switch is cycled, the light setting will return to the default.

### TOOLS > SETTINGS > VENTILATION

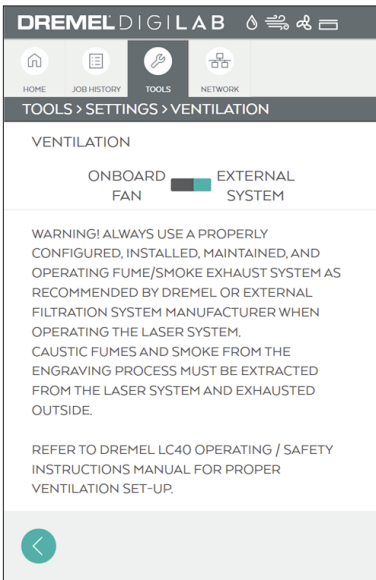

This screen provides an option to select between the internal vent fan and external ventilation systems such as a booster fan, a standalone filtration system, or an external fume ventilation system.

To assure proper removal of fumes produced during operation of Dremel LC40 laser cutter, the ventilation selection must match the actual fume extraction set up. Dremel LC40 must be set up according to instructions provided in the Exhaust Connections chapter of the Setup section on page XYZ to assure proper ventilation.

**ONBOARD FAN** – Select when only the vent fan in the laser cutter is used to exhaust workspace fumes.

**EXTERNAL SYSTEM** – Select if laser unit is connected to a booster fan, standalone filtration system, or an external fume ventilation system.

# LCD TOUCH SCREEN

## TOOLS > SETTINGS > PRIME WATER PUMP

This screen provides control to start the water pump during priming of the laser cooling system.

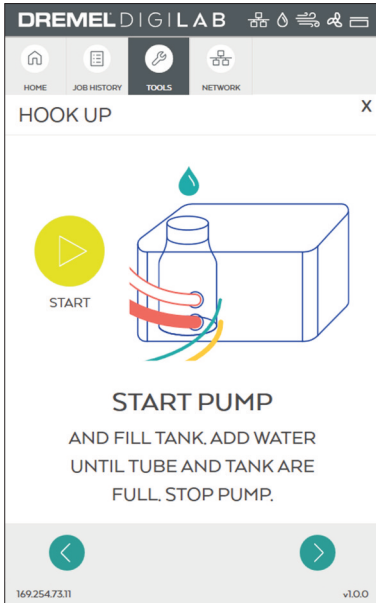

 **START** – Starts the coolant pump.

This screen provides control to stop the water pump during priming of the laser cooling system.

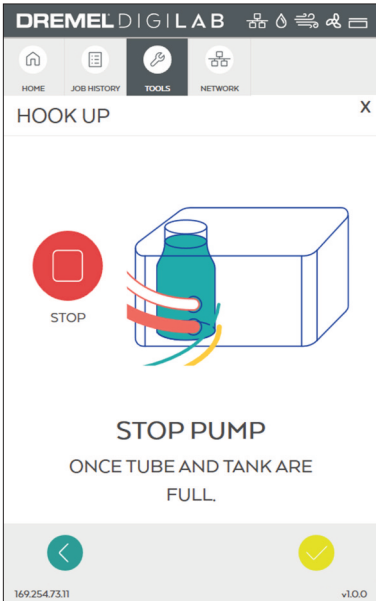

 **STOP** – Stops the pump.



## LCD TOUCH SCREEN

### TOOLS > HELP

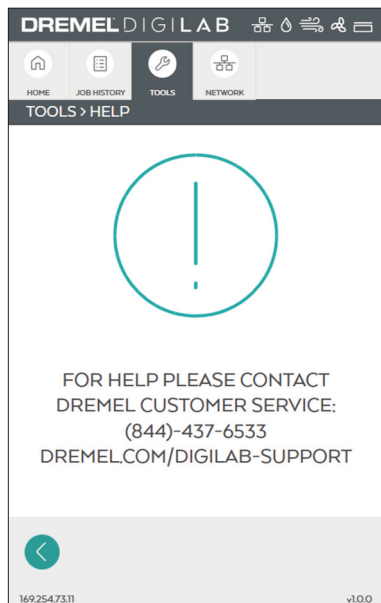

This screen displays customer service contact information.

### TOOLS > TUTORIALS

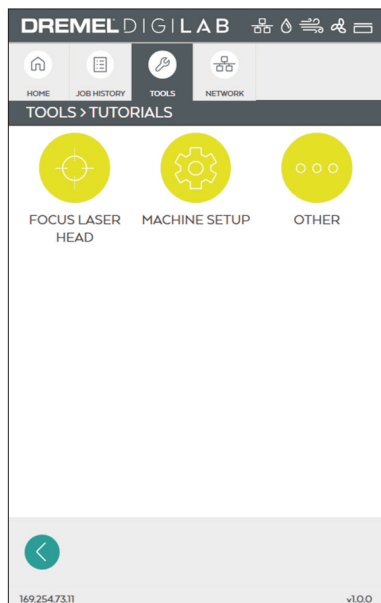

This screen provides access to available tutorial.



**FOCUS LASER HEAD** – Instructions for adjusting the laser head to focus the laser beam on the work piece surface.



**MACHINE SETUP** – Instructions for the initial setup of Dremel LC40.



**OTHER** – Instructions for cleaning of the mirrors and lens.

# LCD TOUCH SCREEN

## TOOLS > TUTORIALS

Sequence of screens stepping through JOB PREP.

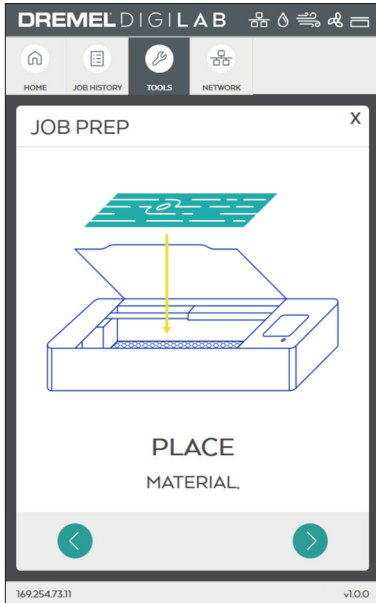

Sequence of screens stepping through HOOK UP.

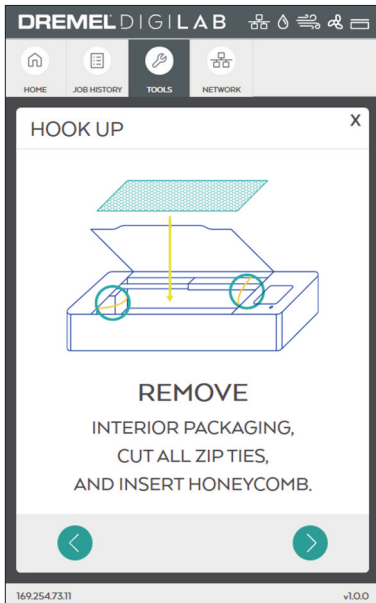

# LCD TOUCH SCREEN

## TOOLS > TEST FILES

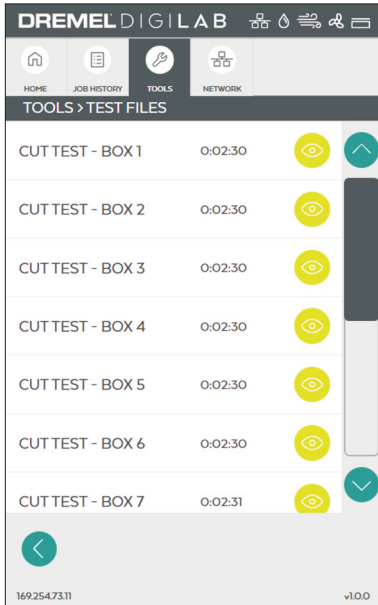

This screen displays available test files and allows their execution.

Test files are used to verify proper operation of select functions and features of Dremel LC40 laser cutter.

- Test Files "CUT TEST - BOX 1" thru "CUT TEST - BOX 12" are used to identify optimized cut and score settings.
- Test Files "ENGRAVE TEST" are used to identify optimized engrave settings.
- Recommended material size for tests: 12"x20"

 Preview the test file.

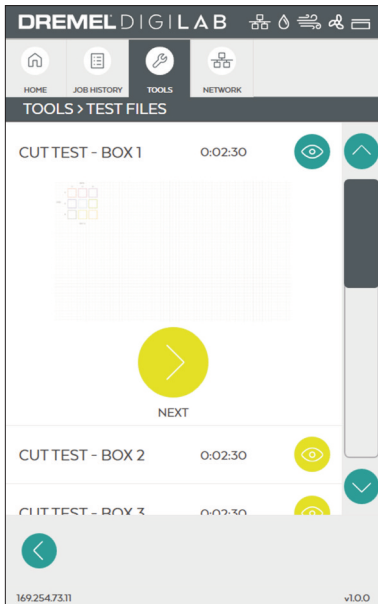

This sample screen illustrates how the option to run a test file can be selected.

 **NEXT** – To start running the job.

# LCD TOUCH SCREEN

## TOOLS > UPDATE SERVICE

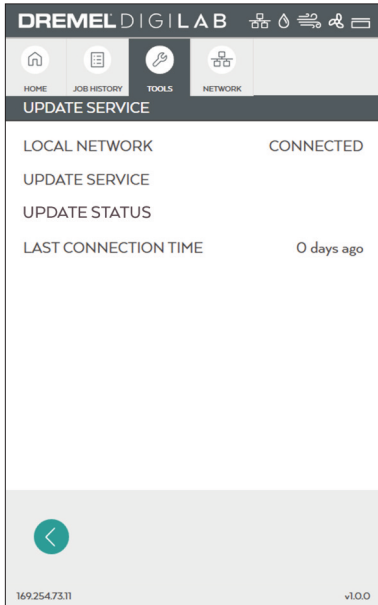

This screen provides network connectivity and status of update service from Dremel.

**LOCAL NETWORK** – Shows whether ethernet or wireless is connected to the local network.

**UPDATE SERVICE** – Indicates if the unit is able to communicate with the update service (Internet connection is required).

**UPDATE STATUS** – Provides information regarding any new software updates.

**LAST CONNECTION TIME** – Shows how long ago the last update service connection was made. If unit is actively connected to update service, then the LAST CONNECTION TIME will not be shown.

If an update is available, an UPDATE AVAILABLE screen and UPDATE PENDING screen will be shown.

The update prompt, which appears on the Home menu screen, allows a user the option of accepting the update or deferring for another time.

## TOOLS > LICENSES

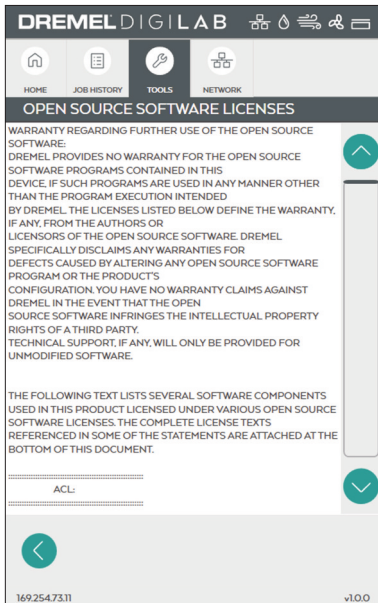

Displays information regarding open source software licenses.

## LCD TOUCH SCREEN

### TOOLS > PRIVACY POLICY

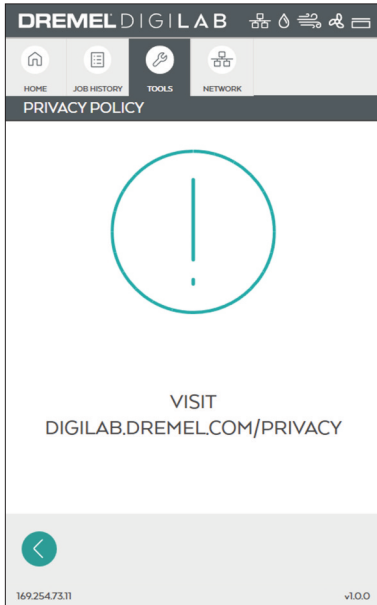

Provides the web address where the current and complete privacy policy can be reviewed.

### NETWORK > MENU SCREEN

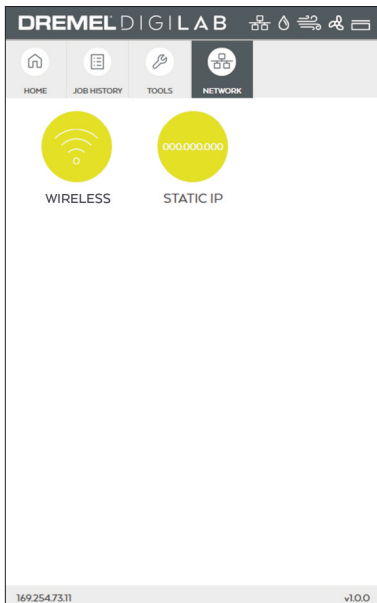

This screen displays the Network connection menu. Available options allow connection or disconnection from the wireless network and set up a static IP address.



**WIRELESS** – Setup or modify a wireless local area network connection for the Dremel laser cutter to connect to.



**STATIC IP** – Setup the Dremel laser cutter to use a Static IP address or default to a DHCP (Dynamic Host Configuration Protocol address) IP address.

# TOUCH SCREEN

## NETWORK > WIRELESS

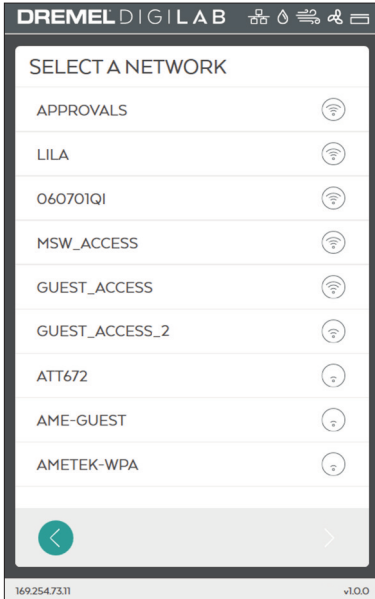

This screens displays wireless networks detected by Dremel LC40.

Selecting an available network will start the connection process.



Wireless network signal strength indicator.

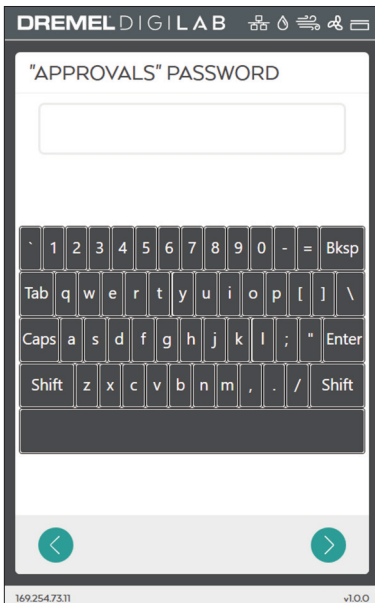

This screen displays the password prompt that appears when a password protected wireless network is selected.

## TOUCH SCREEN

### NETWORK > WIRELESS

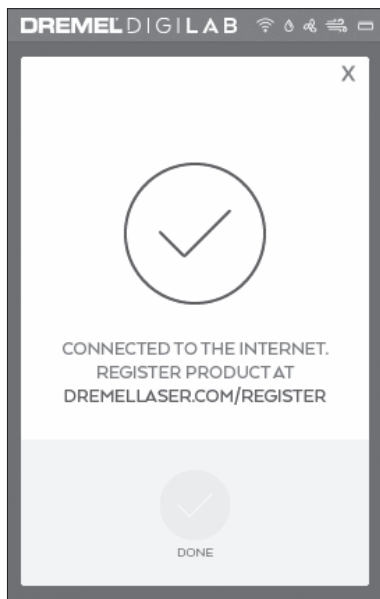

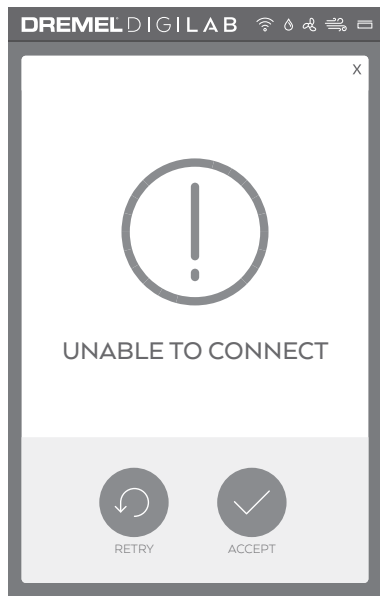

This screen displays a notification that appears when a successful wireless network connection is made.

-  **DONE** – Return to Network menu screen.



This screen displays a notification that appears when connection to the wireless network is unsuccessful.

-  **RETRY** – Allows adjustment of the network information and an attempt to connecting again.
-  **ACCEPT** – Return to Network screen.

# TOUCH SCREEN

## NETWORK > STATIC IP

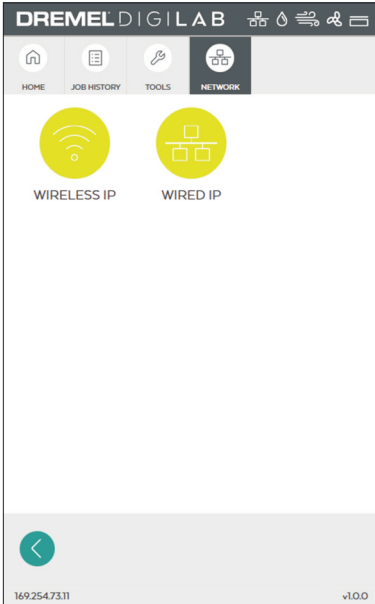

This screen displays network set up options.



**WIRELESS IP** – Allows setup and configuration of the Wireless Network Connection.



**WIRED IP** – Allows setup and configuration of the Wired Ethernet Network Connection.

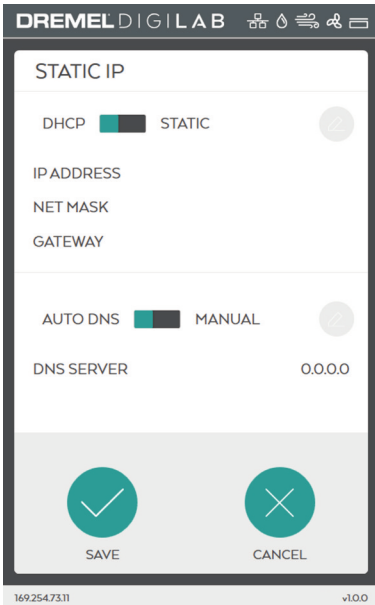

This screen displays options for setting a static IP address for a wireless or a wired (LAN) network.

**STATIC IP** – Allows selection of Static IP address.

**DHCP** – Allows selection of Dynamic Host Configuration Protocol address IP address. Values displayed on IP Address, Netmask, and Gateway are ignored but saved for future use.

**AUTO DNS** – Allows the Dremel Laser Cutter to use the domain name system server as determined by the network router.

**MANUAL** – Allows for inputting a specific DNS server IP address.



Edit settings



**SAVE** – Save Static IP settings.



**CANCEL** – Cancel Static IP setup.



# TOUCH SCREEN

## OPERATION SCREENS

These screens appear during operation.

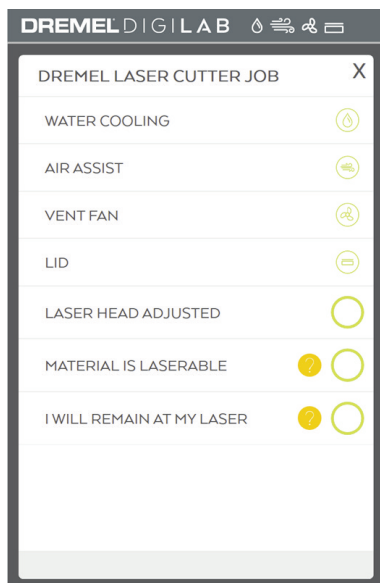

### CHECKLIST SCREEN

This screen displays system checks performed automatically by Dremel LC40 and operator inputs that must be completed before a job can be started.

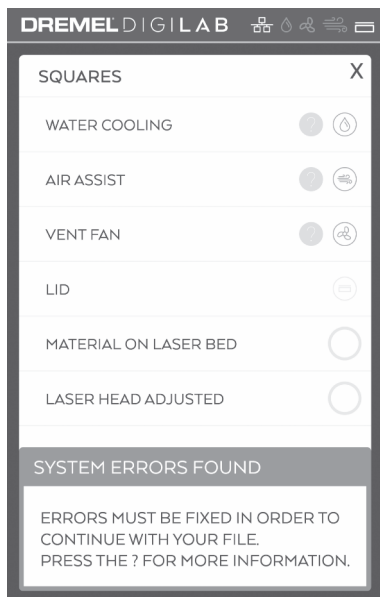

### CHECKLIST SCREEN – ERRORS DETECTED

Displays errors detected in systems of the Dremel LC40 while it is preparing to start a job. The status bar will also display red icons for system or systems where errors were found.



Link to a trouble shooting tutorial related to the system where an error was found.

# TOUCH SCREEN

## OPERATION SCREENS

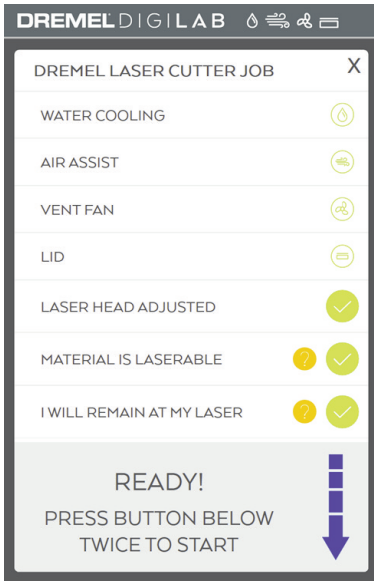

If all icons at the top are white, then items in the checklist should be green.



Manual checks that can be completed after the work piece is placed in the workspace and laser head adjusted using the spacer puck.

To start the job the lid must be closed and the Start Button rapidly pressed twice.

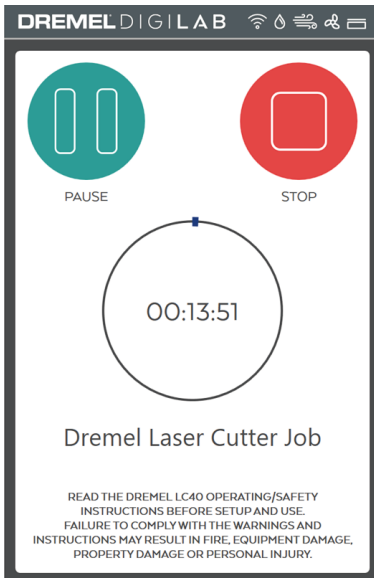

## JOB IN PROGRESS

This screen displays the job file name, time remaining to complete the job, and two control buttons.



**PAUSE** - Temporarily pause the job, which can be resumed from the same place.



**STOP** - Cancel the current job.

# DREMEL LC40 CONTROL SOFTWARE

This section introduces the major interface features of the Laser Control Software. The Laser Control Software is a combination of print driver and control software that communicates with, downloads jobs to, and controls the laser system. There is no download required. The software will link a web browser with the LC40 using the IP address (found at the bottom of the LCD home screen) on the local connection (Wireless or Ethernet).

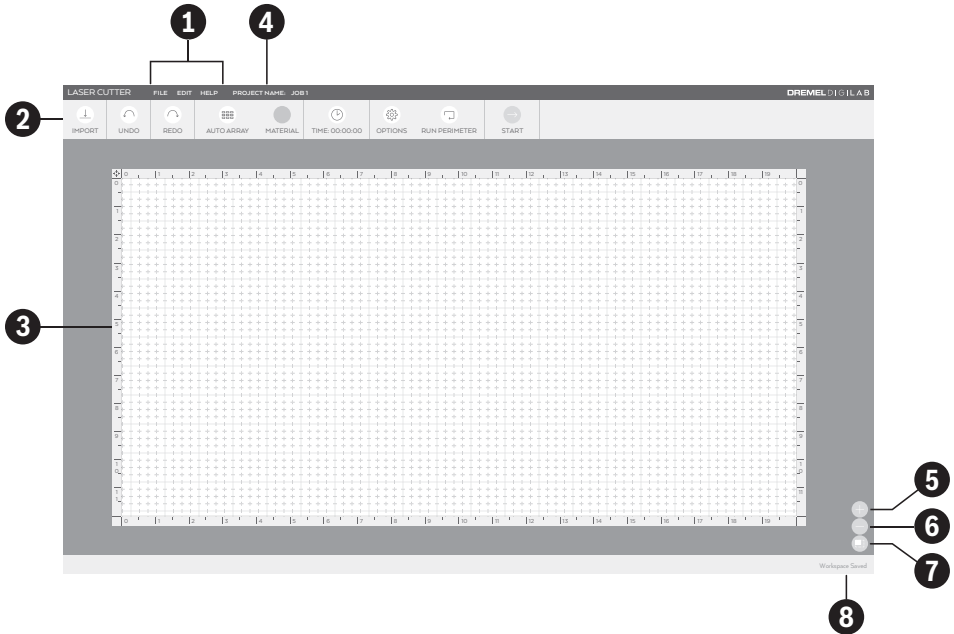

- 1 Menu Bar** – includes the following menu options: File, Edit (shown when a project is opened), and Help.
- 2 Tool Bar** – includes the following tools: Import, Undo, Redo, Auto Array, Material, Time, Options, Run Perimeter, and Start.
- 3 Workspace** – On-screen area where a job is created. Provides a graphical representation of the intended job and its position relative to the general boundaries of the laser working area.
- 4 Project Name** – displays the name of the current project.
- 5 Zoom In** – enlarges workspace screen detail.
- 6 Zoom Out** – reduces workspace screen detail.
- 7 Return to Default Size** – auto size to fit window.
- 8 Status** – displays status of the current project.

# DREMEL LC40 CONTROL SOFTWARE

## Menu Bar

---



LASER CUTTER

FILE

EDIT

HELP

PROJECT NAME: JOB 1

### A. FILE

---

**OPEN** – select to open a file.

**IMPORT** – import a file or use the camera capture feature to create a file or place a picture of your laser bed in the background of your workspace.

### B. EDIT

---

**REDO** – to redo most recent action/change.

**UNDO** – to undo most recent action/change

**COPY** – select to copy the object that is highlighted.

**DUPLICATE** – select to duplicate the object that is highlighted.

**PASTE** – select to paste the object that is highlighted.

**FLIP HORIZONTAL** – select to flip horizontal the object that is highlighted.

**FLIP VERTICAL** – select to flip vertical the object that is highlighted.

**ROTATE RIGHT** – select to rotate right the object that is highlighted.

**ROTATE LEFT** – select to rotate left the object that is highlighted.

**SELECT ALL** – select to select all.

**DESELECT ALL** – select to deselect all.

### C. HELP

---

**ABOUT YOUR LASER** – select to see more details about your laser cutter.

**MANUAL** – select to access the laser manual.

**TUTORIALS** – select to see tutorials for your laser.

**FAQS** – select to see a list of frequently asked questions with answers.

**PROJECT INSPIRATION** – select to browse project inspiration.

**CUSTOMER SERVICE** – select to see customer service contact info.

# DREMEL LC40 CONTROL SOFTWARE

## Tool Bar

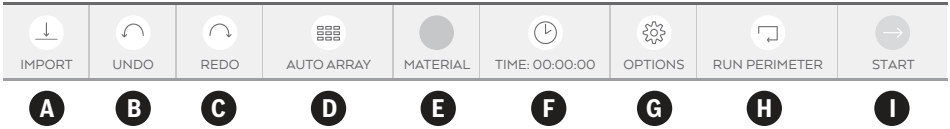

### **A** IMPORT

Click to import a file or use the camera capture feature to create a file or place a picture of the laser bed in the background of the workspace. Alternatively, the file can be dragged and dropped directly into the workspace.

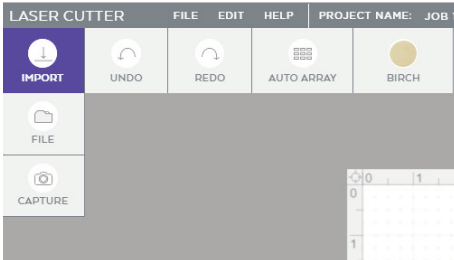

**FILE** – Use import/file to bring in a file as typically done in other software programs. For PDF files the options are to bring in only cut files, only engrave files, or both. Select the option from the drop down menu. All other file types will default to either engrave or cut based on their optimal application.

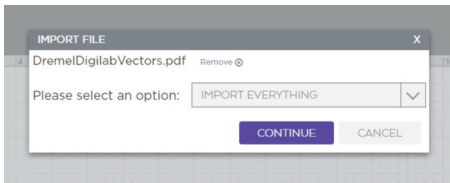

**CAPTURE** – Use import/capture to take advantage of the camera capture feature. This can be used to either place a picture of the material that's on the honeycomb plate, into the background of the software workspace. This feature can be used for placing a file on top of an oddly shaped material, or to take a picture of a sketch, and transform that sketch into a file that can be engraved or cut.

### **B** UNDO

Click to undo most recent action/change.

### **C** REDO

Click to redo most recent action/change.

### **D** AUTO ARRAY

Choose the object to duplicate. Then click and highlight the number of times to duplicate the object.

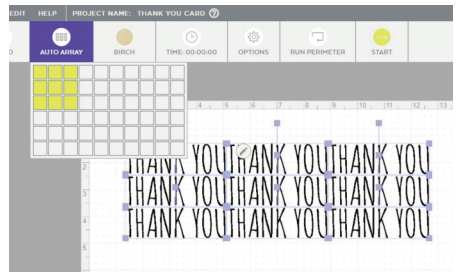
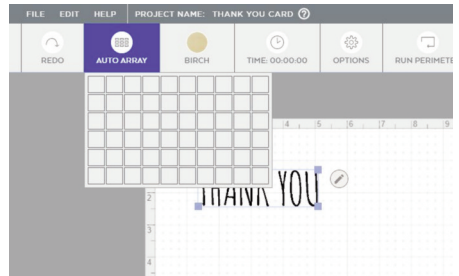

# DREMEL LC40 CONTROL SOFTWARE

## E MATERIALS

**⚠️ WARNING** Observe all provided warnings and safety instructions when using the Dremel LC40. Failure to do so may result in fire, equipment damage, property damage or personal injury.

**⚠️ WARNING** Never engrave or cut any unknown material. Only engrave materials recommended by the manufacturer. The vaporization/melting of many materials, including but not limited to PVC and polycarbonates, can give off hazardous fumes. Always refer to the Safety Data Sheet (SDS) from the material manufacturer to determine the response of any work material to extreme heat (burning/fire hazard) to prevent hazards.

Click to select a material from the list of Dremel provided defaults, or choose “more” to add/delete/edit the list of favorite materials. Use the star to denote a default material that will be saved and used for all jobs, until changed. The settings that are populated when a material is selected will be applied to all files brought in, unless edited in the print settings box, or changed in the materials list.

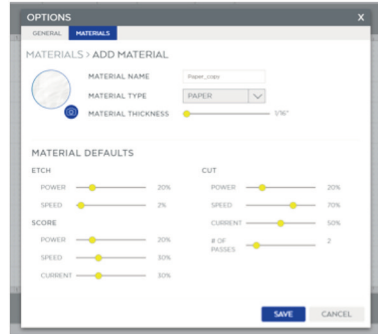
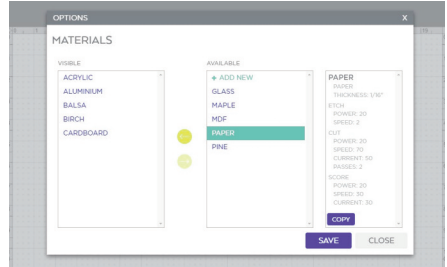

## F TIME

Click to calculate a rough estimate of how long the job will take to complete.

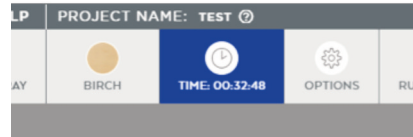

## G OPTIONS

Displays more advanced settings and defaults.

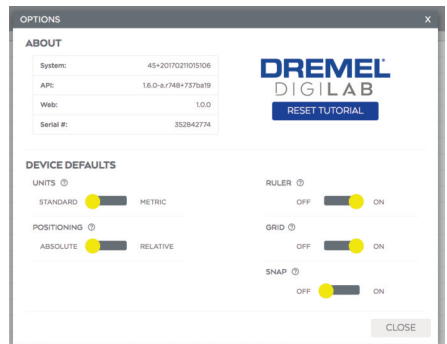
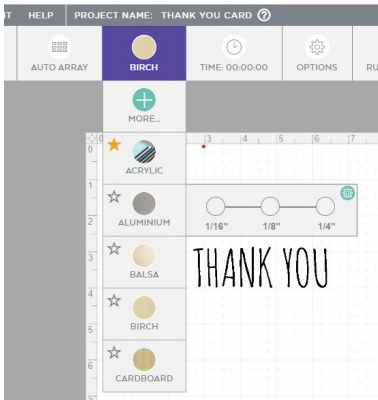

# DREMEL LC40 CONTROL SOFTWARE

## H RUN PERIMETER

Laser head will move along the exterior perimeter of the job. Click again to stop this motion, otherwise it will continue running.

**PAUSE** – Appears once a job starts and will pause the job.

## I START

This button will send the job to the laser.

**STOP** – Appears once the job starts and will cancel the job.

## PRINT SETTINGS

A print settings box will pop up when clicking on an imported file. There are two tab options at the top (Cut/Score and Engrave), and only the ones that are applicable for that file type will be highlighted. This box can be moved anywhere on the screen simply by dragging it. **The jog in the top right corner will expand “advanced” settings for more control.** The “X” will minimize the box and can be reopened by clicking on the pencil that appears.

## CUT

This function is used when cutting through a work piece. This function is also called “vector” since a vector, or line file is needed in order to execute. The laser head will follow the lines of the file. The software will detect up to 21 different colors in a line file and allow adjustment of the print settings based on those colors. The order that the different colors are cut can be adjusted in the print preview screen once ready to send.

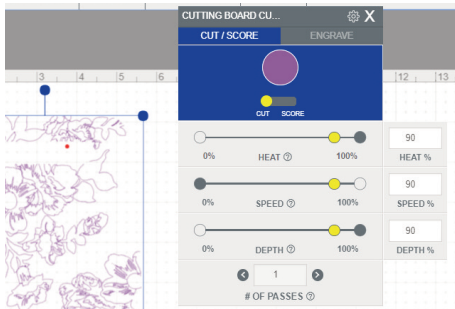

Print Settings box (Cut)

**HEAT** – Adjust how quickly the laser is firing, or how much heat is generated on the surface of the work piece. Turning up the heat will cause charring for materials like wood or paper, but will create a glossy edge for a material like acrylic.

**SPEED** – Adjust how quickly the laser head moves. Slowing the laser head down allows it to cut deeper into the work piece, while turning the speed up prevents the cut from going as deep.

**DEPTH** – adjust to control how deep the laser will go into the work piece. Turning up the depth will increase the likelihood that the work piece will be cut all the way through.

**# OF PASSES** – adjust to control how many times the laser traces over the lines. Increasing the number of passes means the laser will execute that job, then immediately execute it in the exact same location however many times entered. Increasing the number of passes can be an effective way to ensure the work piece is cut all the way through, especially as the thickness of the material goes up.

## SCORE

A function when it is preferred not to cut all the way through the work piece. This function requires a vector, or line type file and is most useful when emphasizing the outline of text or an object. It is very similar to “cut,” but the software will default to less powerful settings, in an attempt to mark the work piece, but not cut all the way through it.

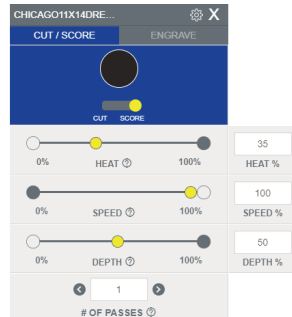

Print Settings box (Score)

# DREMEL LC40 CONTROL SOFTWARE

## ENGRAVE

This function darkens or removes the surface of the work piece, rather than cutting through it. This function is also known as “raster” and will require an image file to execute. The laser head will move side to side like an inkjet printer.

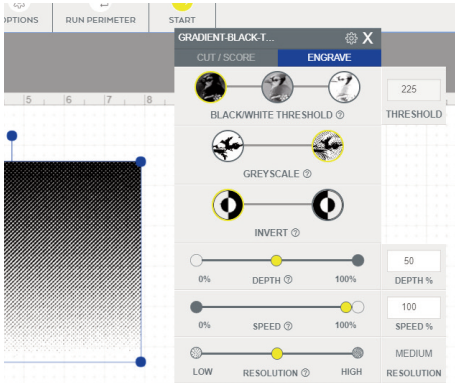

Print Settings box (Engrave)

**BLACK/WHITE THRESHOLD** – Use this to adjust the amount of black that is included in the image. The furthest left setting will include a larger amount of black from the file, while the furthest right setting will include less black, or a larger amount of white.

**GREYSCALE** – Takes a black and white image and assigns different densities of dots to visually create a number of different shades of grey. Darker areas of the image will have more dots, while lighter areas will have less dots. This is useful for images that have a lot of different colors, and it is desired that the finished product appear more realistic. This setting can be toggled on or off.

**INVERT** – This setting will transform the image so that the white areas become black, and the black areas become white.

**DEPTH** – Adjust to control how deep the laser will go into the work piece. Turning up the depth will remove more material, so that a noticeable void is felt when touching the work piece, creating almost a 3D effect.

Turning down the depth will keep the surface of the work piece relatively flat or even.

**SPEED** – Adjust how quickly the laser head moves. Slowing the laser head down will generally make the engraving darker or deeper, while turning the speed up typically results in a lighter finish.

**RESOLUTION** – 3 different resolution options are available: low, medium, high. This setting adjusts the DPI (dots per inch) in the image, the low setting will be faster and lighter than the high setting. In low setting the resolution is pixelated, or individual dots are easy to see. The high setting will result in a less pixelated final result.

## JOB PREVIEW

After pressing “start” the PREVIEW screen allows review of all the settings and placement of the files before sending the job to the laser. Changes can be made to the order the files execute. By default, engraving is completed first then cutting. If other settings need to be adjusted, exit out of this box before sending the job. If everything looks correct, the job can be sent to the laser. The physical start button on the laser must be pressed twice before the job will begin.

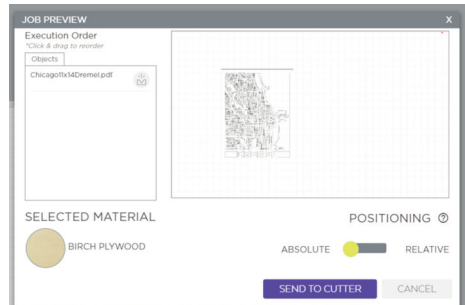

Job Preview Screen



## SETUP

**⚠ WARNING** Observe all provided warnings and safety instructions when using the Dremel LC40. Failure to do so may result in fire, equipment damage, property damage or personal injury.

**⚠ WARNING** Disconnect the plug from the power source before making any assembly, adjustments or changing accessories. Such preventive safety measures reduce the risk of starting the Laser Cutter accidentally.

### Cut and Remove Zip Ties

Once all interior packaging has been removed from the laser, locate both zip ties securing the laser head and gantry.

One zip tie can be found at each end of the gantry.

Using a small pair of scissors or diagonal cutting pliers, carefully cut and remove both zip ties. DO NOT cut any other cord or wire. Be aware that the laser tube is extremely fragile. Be careful NOT to damage any part of the machine during this process.

Fig. 5

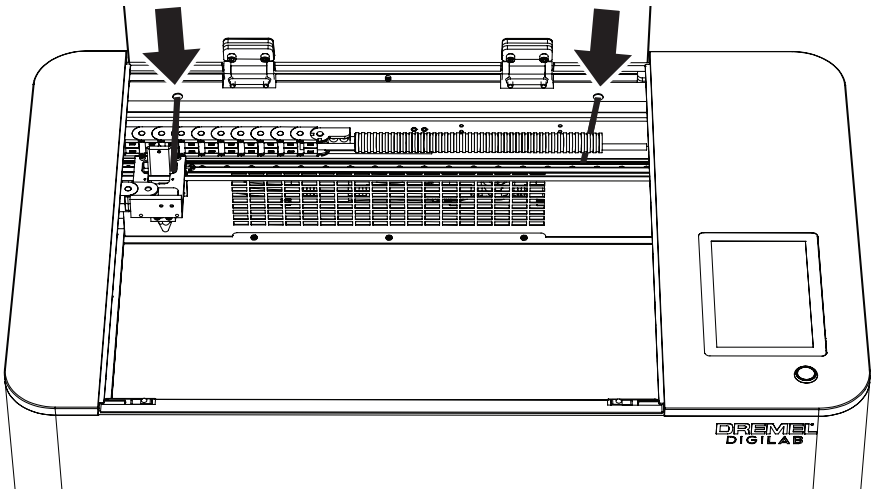

## SETUP

### Install Honeycomb Plate

Place the honeycomb plate inside the laser on the laser bed. Be careful not to damage any part of the machine during this process. The head can be moved out of the way by hand if necessary.

The honeycomb plate sits flat at the bottom of the laser. There is a slight recess in the bed to help align the honeycomb plate (Fig. 7).

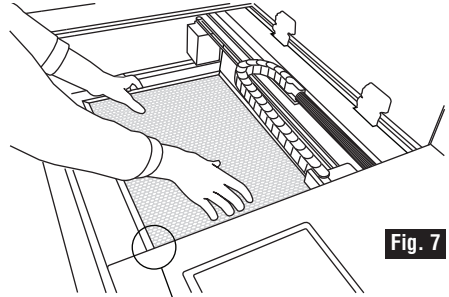
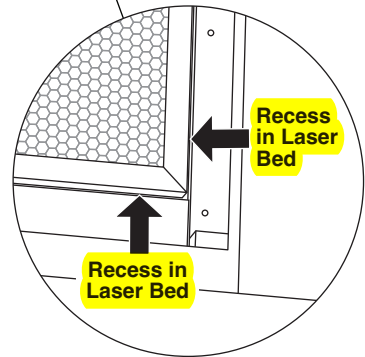

Fig. 7



### Remove Camera Lens Cap

Remove the cap from the camera lens on the laser head.

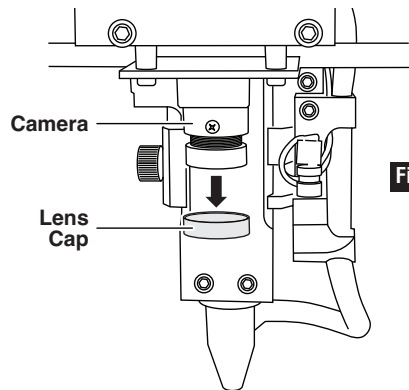

Fig. 8

# SETUP

## Attach Water Hoses

1. Place the Hex Box™ in the workspace. The maximum distance the Hex Box™ can be placed from the laser cutter is 5 feet.
2. Remove the short silicone tubing capping the water inlet and outlet on the back of both the laser cutter and the Hex Box™.
3. Match the blue and clear water tubes to the appropriate inlet and outlet fittings on the laser cutter and the Hex Box™, Fig. 9 & 10. The fittings are labeled with colors to help identify the appropriate tubes.

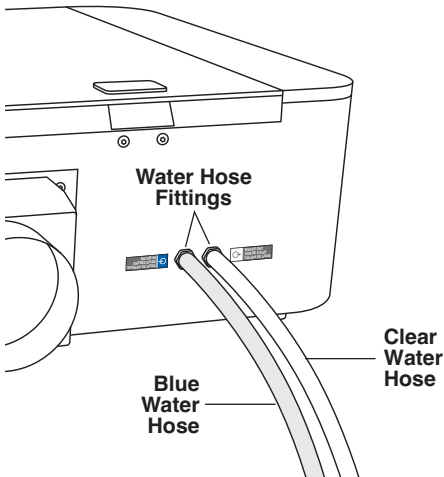

Fig. 9 — Rear of Laser Cutter

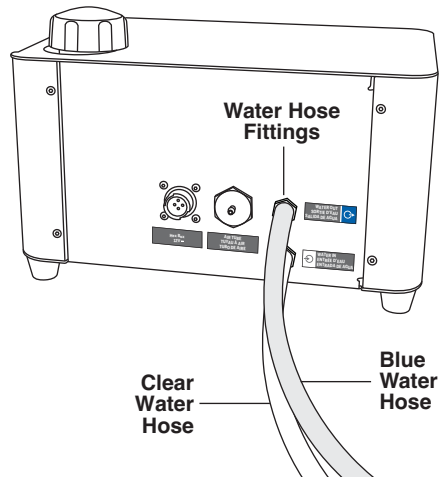
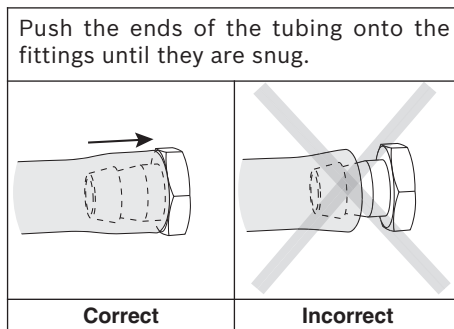

Fig. 10 — Rear of Hex Box™



# SETUP

## Attach Air Tube

Connect the Air Tube to the fittings on the laser cutter and the Hex Box™. There are labels on the laser cutter and the Hex Box™ to help identify the correct fittings. Fig. 11 & 12.

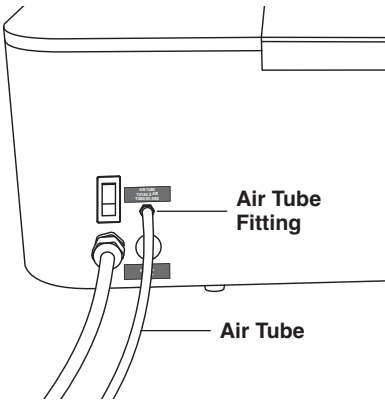

Fig. 11 — Rear of Laser Cutter

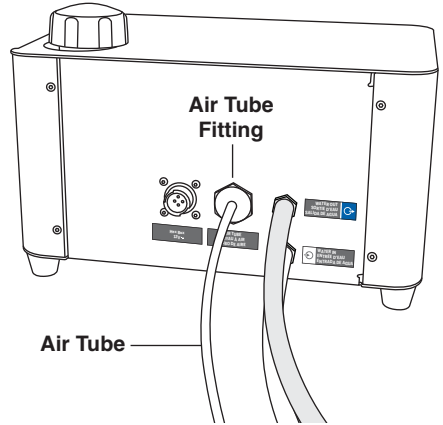
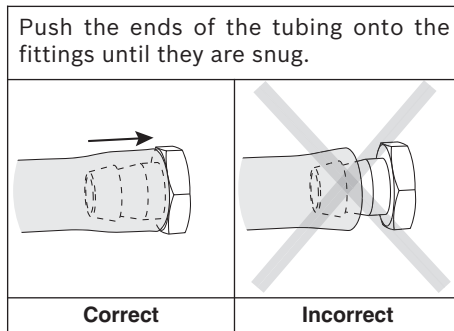

Fig. 12 — Rear of Hex Box™



## SETUP

### Connect Hex Box™ Connector Cord

Connect the Hex Box™ connector cord to the laser cutter and the Hex Box™. Fig. 13 & 14.

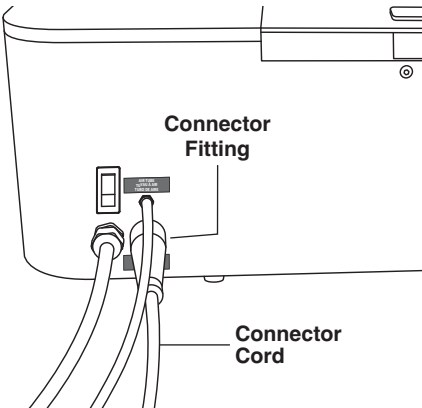

Fig. 13 — Rear of Laser Cutter

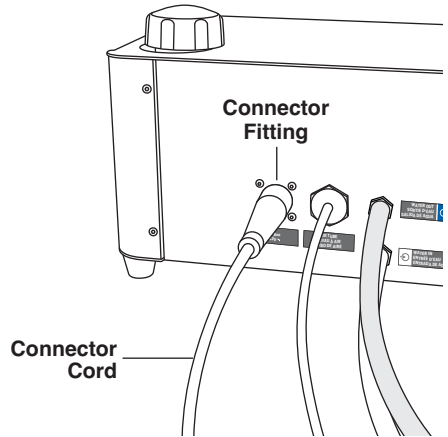

Fig. 14 — Rear of Hex Box™

### Attach Exhaust Shroud

Using a screwdriver, attach the exhaust shroud to the back of the laser cutter, Fig. 15. Ensure that the shroud is flush against the back surface of the laser cutter.

Attachment of the exhaust tubing to the shroud is explained in the Exhaust Connections section.

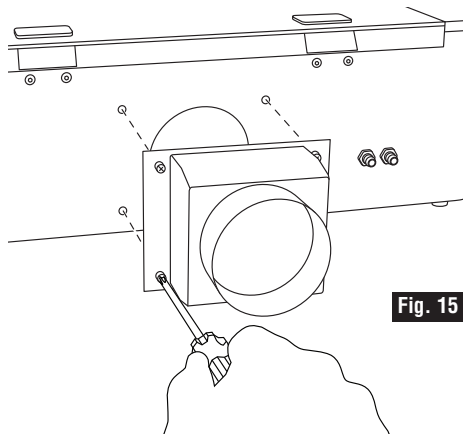

Fig. 15

# SETUP

## Exhaust Connections

### Venting/Exhaust

**⚠️ WARNING** Observe all provided warnings and safety instructions when using the Dremel LC40. Failure to do so may result in fire, equipment damage, property damage or personal injury.

**⚠️ WARNING** Always use the laser cutter with a properly functioning exhaust and/or a filtration system. Emissions from some materials and the long-term effects to exposure are unknown, which may lead to personal injury.

It is important to properly vent the laser exhaust system. The laser melts and/or burns material as it moves along its axis and depending on the type of material can generate smoke. The smoke is

composed of particulates, fumes and gases. The exhaust is necessary to remove these products.

### Exhaust Scenarios:

Case 1; Digilab LC40 is used with internal exhaust fan.

Case 2; Digilab LC40 is used with an in-line exhaust duct booster fan.

Case 3; Digilab LC40 is used with an external air filtration system.

**Use Case 1:** The LC40 will use the supplied flexible duct and internal exhaust fan to vent to the outside of the building.

Choose a well-ventilated area to set-up the Digilab Laser.

Securely connect one end of the flexible exhaust duct to the laser exhaust shroud

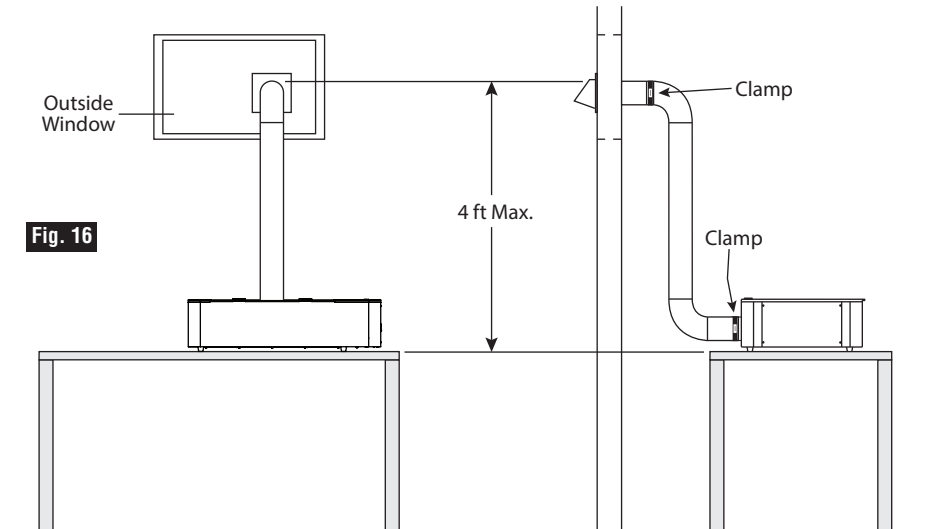

Fig. 16

Exhaust system configuration example using the DigiLAB internal exhaust fan. When using the internal exhaust fan be sure to choose correct ventilation option on the LCD during the laser startup sequence.

Attach the flexible duct to the laser exhaust manifold with the hose clamp provided. Extend the flexible duct the required length to reach the vent hood keeping it as straight as possible. Cut the excess duct off with wire cutters and attach to the vent hood with the hose clamp provided. Stretching the duct and keeping it straight improves exhaust flow through the duct.

# SETUP

## Clearance Requirements from Vent Terminations to Building Openings for SV Models

\* All clearance requirements are in accordance with ANSI Z21.10.3 and the National Fuel Gas Code, ANSI Z223.1 and in Canada, in accordance with NSCPNGPIC.

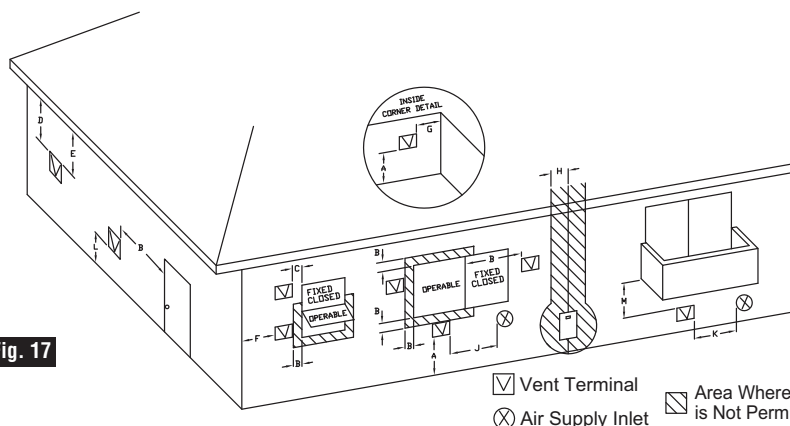

**Fig. 17**

	Clearance	Indoor Installation (See p.9)	Outdoor Installation (See p.9)
A=	Above grade, veranda, porch, deck, or balcony	12" (12")	12" (12")
B=	Window or door that may be opened	4' below or to the side of opening, or 1' above opening (36")	12" (36")
C=	Permanently closed window	*	*
D=	Vertical clearance to ventilated soffit located above the terminal within a horizontal distance of 2 feet from the center of the terminal	*	*
E=	Unventilated soffit	*	*
F=	Outside corner	*	*
G=	Inside corner	*	*
H=	Each side of center line extended above meter/regulator assembly	3' within a height 15' above meter/regulator assembly	3' within a height 15' above meter/regulator assembly
I=	Service regulator vent outlet	3'	3'
J=	Nonmechanical air supply inlet or combustion air inlet to any other appliance	4' below or to the side of opening, or 1' above opening (36")	12" (36")
K=	Mechanical air supply inlet	3' above if within 10' (6')	3' above if within 10' (6')
L=	Above paved sidewalk or paved driveway located on public property	(7' ***)	(7' ***)
M=	Under veranda, porch, deck, or balcony	* (12"- Canada Only****)	* (12"- Canada Only****)

(=) indicates clearances required in Canada

\*Maintain clearances in accordance with local installation codes and the requirements of the gas supplier

\*\*\*A vent shall not terminate directly above a sidewalk or paved driveway that is located between two single family dwellings and serves both dwellings.

\*\*\*\*Permitted only if veranda, porch, deck, or balcony is fully open on a minimum of two sides beneath the floor.

## SETUP

and the other end to the louvered duct outlet with included hose clamps. Minimize the number of 90-degree bends. You should be able to limit the number of bends to two. If replacing a windowpane, use a wooden board or similar with a 4" diameter cut out to place in the window opening. Use foil tape to close any gaps between the outer diameter of the duct and the board and between the board and the window frame, doorframe, or opening that was chosen. See fig. 13.

**Use Case 2:** The LC40 will use the supplied ducting and an in-line exhaust duct booster fan to vent the LC40 outside of the building.

Choose a well-ventilated area to set-up the Digilab Laser.

Securely connect one end of the flexible

exhaust hose to laser exhaust manifold and the other end to the blower air inlet side with included hose clamps. Take the second hose and securely connect one end – using supplied clamps - to the blower's air outlet side and route the other end to the outlet vent. Total combined length for the two ducts must not exceed 20 feet. Minimize the number of 90-degree bends. Set up should never have more than four bends.

Use a wooden board or similar with a 4" diameter cut out to place in the window opening or the chosen opening to block air from coming in. Use foil tape to close any gaps between the outer diameter of the hose and the board and between the board and the window frame, doorframe, or opening that was chosen. See fig. B.

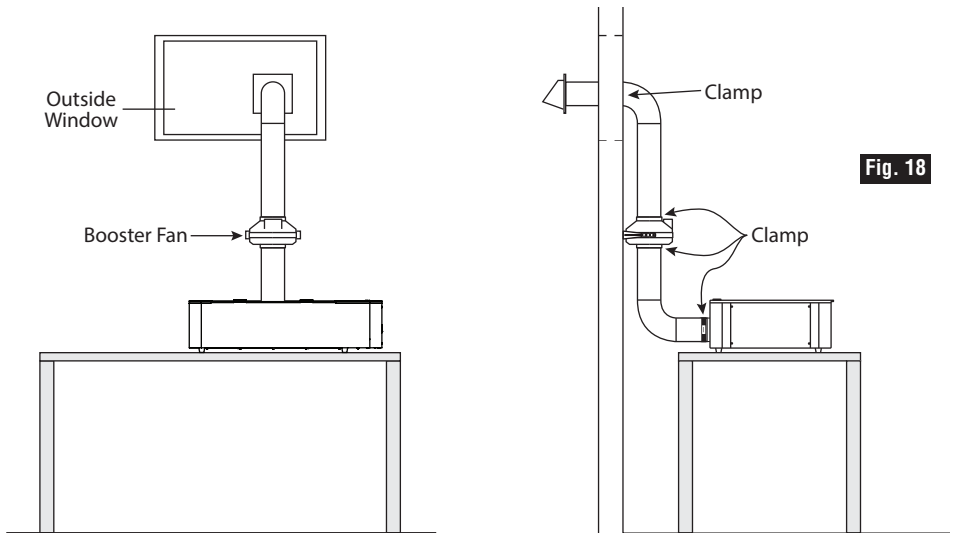

Exhaust system configuration example using an external in-line duct exhaust fan. When using an external exhaust fan be sure to choose correct ventilation option on the LCD during the laser startup sequence.

Attach the flexible duct to the laser exhaust manifold with the hose clamp provided. Extend the flexible duct the required length to reach the exhaust fan. Secure the duct with the provided hose clamp. Mounting the fan to the wall keeps the duct length to a minimum. However, other configurations are possible depending on the location of the outlet vent hood. Keep the duct length short and straight and cut off the excess with wire cutters. Attach the duct to the exhaust fan and outlet vent with the hose clamps provided.



## SETUP

### Other precautions:

- Do not locate the vent termination near a window or any other structure, which has glass facing the termination.
- Avoid installation where the unit will be exposed to excessive winds.
- Install in a location where the exhaust gas flow will not be affected by fans or range hoods.
- Take care that exhaust gas will not affect neighbors.
- If snow is expected to accumulate, insure the end of the duct hood is not covered with snow or hit by falling lumps of snow.
- Never install the outlet in a below grade such as in a window well.
- Always duct the exhaust to the outside of the building away from where people may congregate. For exhaust placement recommendations relative to windows, doors, air inlets and other opening see figure 15.
- Make-Up Air

One important design criterion for any heating, cooling or ventilation system is called “make-up air” or “replacement air.” This is based on the idea that whenever your laser vent system sucks air out of a sealed room, that creates a vacuum, unless you provide a source of make-up air to replace the air you are evacuating. This serves the same purpose as having air returns in each room of a house with a forced-air heating or cooling system.

A source of make-up air is important in any laser vent system. Without adequate replacement air, exhaust efficiency can drop and result in an inability of the vent system to remove the fumes from a room operating under vacuum pressure.

A temporary make-up air system can be as simple as opening a window in the work area, although this may not be very practical in a commercial shop. Users often provide replacement air by running a length of duct from the outdoors to (near) the laser.

Always select a route that will provide the straightest and most direct path outdoors. Never use PVC or other nonconductive duct materials for the exhaust system. Always use rigid or flexible metalized ducting in the exhaust system. Flexible metalized ducting must be UL181 rated. Improper selection of ducting can cause static charges, may result in dust build up inside the duct, and may cause a risk of fire or combustion.

Check local building codes and with your home owner association rules and regulations to ensure your laser is not in violation of any ordinances, rules and regulations. Always use the steel hose clamps provided with your DigiLAB laser to connect ductwork. Always use foil duct tape at connections to prevent the escape of small amounts of particulates, smoke and fumes.

Always use the Dremel DigiLAB laser in a well-ventilated area.

Setup recommendation:

- 2 x 10 feet exhaust hose maximum (provided with the DigiLab Laser).
- Never use an exhaust hose smaller than 4” diameter.
- Ensure that the hose is never coiled, kinked or flattened.
- Exhaust routing: Recommending a set up with no elevation rise (see figure xyz).
- Maximum two 90-degree bends per hose.

## SETUP

- Use low-pressure drop vent louvers. Typically found on clothes dryers and bathroom vent fans.

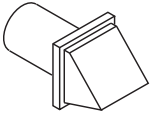

Single louver ducts recommended

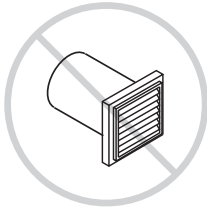

Multi louver ducts NOT recommended

Exhaust system configuration example using the DigiLAB internal exhaust fan. When using the internal exhaust fan w/ blower assistant, be sure to choose correct ventilation option on the LCD during the laser startup sequence.

### Recommended features for an exhaust vent hood:

- **IMPORTANT:** Choose a single, lightweight louver/damper which requires minimal exhaust duct flow to open.
- Wide mouth anti-gust hood design.
- Damper prevents back-flow of exhaust air.
- Screen/grate to keep out birds and rodents.
- Always use rigid or flexible metalized

duct tubing. Never plastic. Plastic box hood and louvered hood sections are acceptable.

- Always use the supplied flexible metalized duct. If additional duct is required, it must meet Underwriters Laboratory specification UL181.
- Rigid metal duct tubing can be used but, all seams must be sealed with foil tape.
- Semi rigid duct is not recommended because of the potential for fume leaks along the spiral crimp.

**Use Case 2:** The unit will use a secondary standalone portable filtration system:

**⚠ WARNING** Before setting up and operating the Portable Filtration System, read the portable filtration system instruction manual.

Set-up with Portable Filtration System:

Choose a well ventilated area to set-up the DigiLab Laser and portable filtration system.

If you have purchased the DigiLab Laser Bundle with the filtration system or if you have purchased another Portable Filtration System, follow the instructions below:

Read the instruction manual of the supplied filtration system to properly set up the filtration system unit.

**Fig. 19**

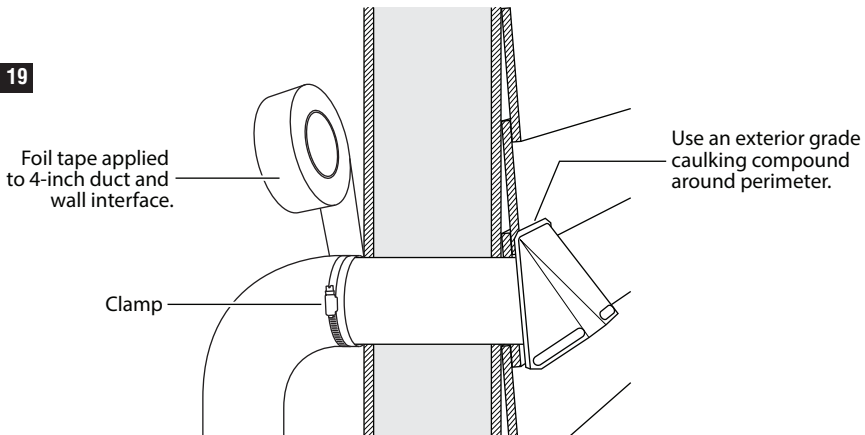

## SETUP

Fig. 20

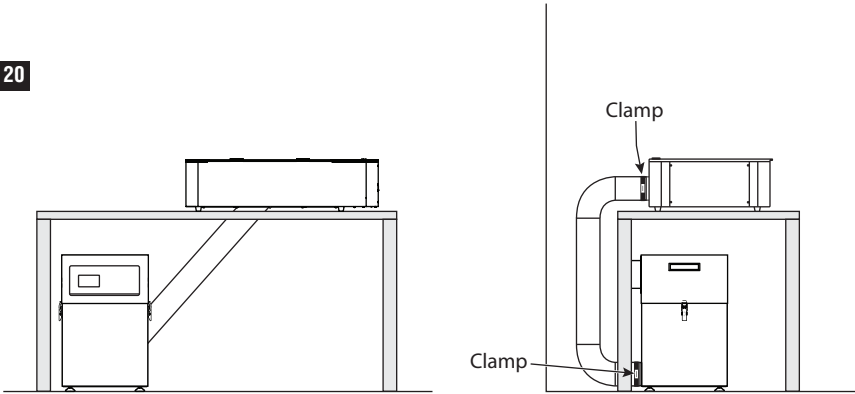

Do not common vent this appliance to an existing ventilation system without an HVAC professional to ensure proper airflow and compliance with local building code regulations.

### Connecting the Laser to the Filtration System:

Use the 10' exhaust hose supplied with the laser and connect securely on end of the hose to the shroud at the back side of the Laser and the other end to the inlet of the air filtration system, using the supplied hose clamps (see figure 17). Expand the hose to the length needed to connect the laser to the filtration system. Ensure that the hose is never coiled, kinked or flattened.

Always turn on the filtration system before starting the job and let it run for about 30 seconds after the job is finished to evacuate fumes and gases out of the Laser before lifting the glass lid of the Laser. Always turn off the exhaust system in between jobs to extend the life of the filters.

Always use the Dremel DigiLAB laser and Filtration system in a well-ventilated area.

Filter change frequency of the filtration system: Follow the instructions for filter change per the manual of the portable filtration system.

Recommendations for units:

- Insure a minimum 200 cfm and 35 inches water column (87mbar) pressure.
- Unit must be Underwriters Laboratory listed for safety.
- Utilize HEPA filter technology and carbon filter technology.
- Filtration system must be listed by the manufacturer as approved for use with Laser cutters/engravers.

## SETUP

**⚠️ WARNING** Observe all provided warnings and safety instructions when using the Dremel LC40. Failure to do so may result in fire, equipment damage, property damage or personal injury.

### Plug in the Laser Cutter

Plug the Power Cord from the back of the laser cutter into a grounded outlet.

Note: The Laser Cutter draws about 6.0 Amps at its maximum power. Be careful not to connect too many other devices on the same circuit. Make sure not to exceed the current rating of the circuit.

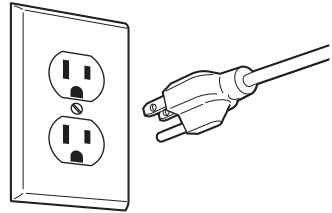

Fig. 21

### Test GFCI Unit

**⚠️ WARNING** Test GFCI before each use. Do not use Dremel LC40 if the GFCI indicator does not turn red after pressing the RESET button. Take Dremel LC40 to a Dremel authorized service center for repair.

**⚠️ WARNING** Do not use laser cutter with extension cords. The GFCI on the machine power cord will not prevent electrical shock from the extension cords.

**⚠️ WARNING** Test before each use. A faulty GFCI can result in electric shock.

The laser cutter is equipped with a GFCI (ground fault circuit interrupter) unit mounted on the cord, Fig 22.

1. Press 'TEST' button. Red should disappear from the indicator window.
2. Press and release 'RESET' button. Red should reappear in the indicator window.

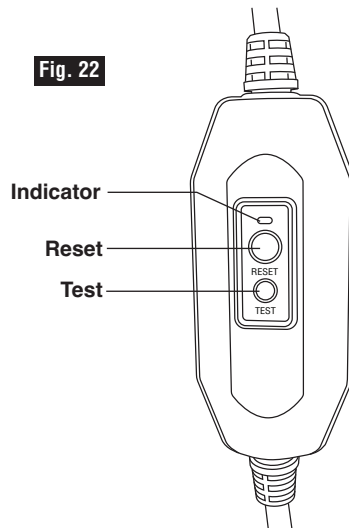

Fig. 22

# SETUP

## Turn On the Laser Cutter

Locate the power switch at the back of the unit (above the power cord) and turn the laser cutter on.

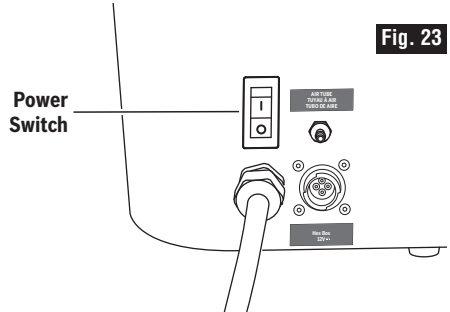



Fig. 23

## Get Started

When the unit is powered on for the first time (or if a factory reset is performed) the touchscreen will present the following screens:

- Select a country,
- Select a language,
- End-user license agreement (EULA),

After following the directions in the prior screens, the Get Started screen will appear.

 Tapping the Next button starts the hook up screens. The screens review previous steps outlined in the Operating/Safety Instructions.

After confirming all hoses and connections are correct, stop at the Start Pump screen and follow the instructions below.

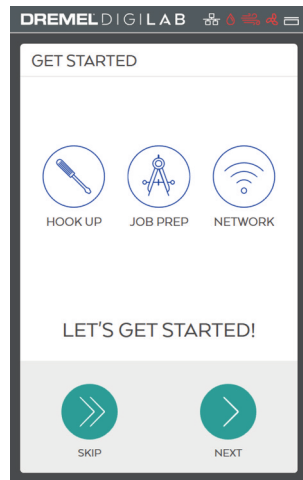

## SETUP

**⚠️ WARNING** Observe all provided warnings and safety instructions when using the Dremel LC40. Failure to do so may result in fire, equipment damage, property damage or personal injury.

### Fill Hex Box™ with Distilled Water

**⚠️ CAUTION** Do not spill water on the Hex Box™ unit. Damage to electronics may occur.

1. Start the water pump by tapping the start button on the laser cutter's LCD screen.



**START PUMP**  
AND FILL TANK. ADD WATER  
UNTIL TUBE AND TANK ARE  
FULL. STOP PUMP.

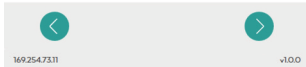

2. Using a funnel, fill the Hex Box™ with distilled water until the water tank is full, figure 24.

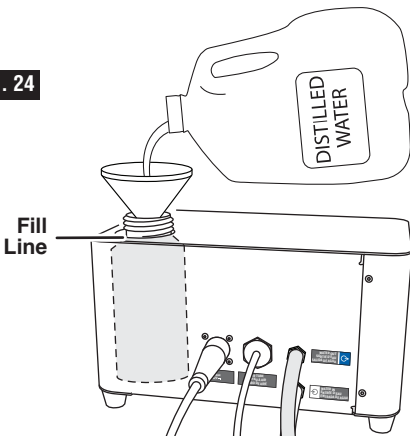
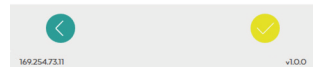

**Fig. 24**

3. Add distilled water to the water tank until there are no visible bubbles in the Laser Tube and water level in the tank has stabilized at full.
4. When the tank is full, tap next button to proceed to the stop water pump screen.
5. Stop the water pump by pressing the stop button on the laser cutter's LCD screen.



**STOP PUMP**  
ONCE TUBE AND TANK ARE  
FULL.



6. Screw on the Hex Box™ Cap.

## SETUP

### Connect a Computer to the Laser Cutter

#### For a hardwire connection:

1. Connect the Ethernet Cord to the laser cutter (Fig. 25) and the computer.
2. Open an internet browser window on the computer.
3. Type in the "IP" number displayed at the bottom of the laser cutter's LCD screen into the browser's URL bar.

Fig. 25

Ethernet Port

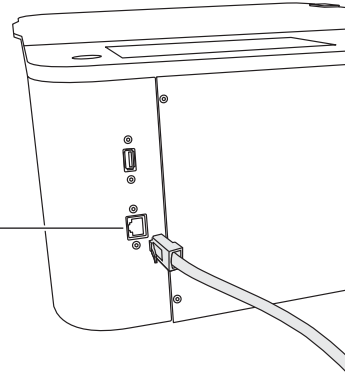

#### For a wireless connection:

1. Select Network on the laser cutter's LCD screen, then select Wireless from the Network menu. (Fig. 26)
2. Select a network from the list of available networks, then enter password to connect the laser cutter.
3. Open an internet browser window on the computer.
4. Type in the "IP" number displayed at the bottom of the laser cutter's LCD screen into the browser's URL bar.

Fig. 26

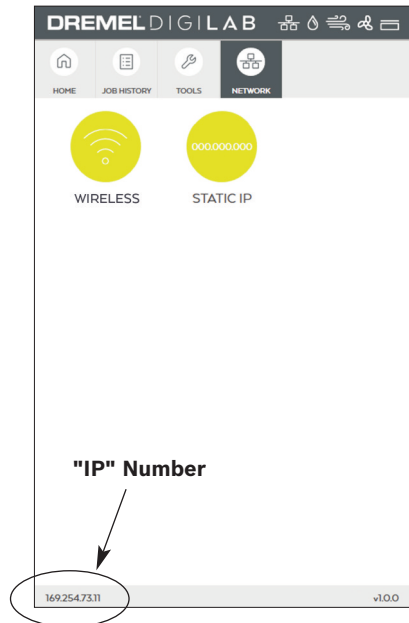

**Static IP:** Connect to the network by assigning a persistent IP address that is assigned for the machine. This address will be maintained permanently and will not change if the machine is rebooted.

*TIP: If the Dremel LC40 Control Software is taking a while to load, or not working properly try refreshing the browser to reload the software.*

# SETUP

## Network Setups

### PEER TO PEER ETHERNET CONNECTION

#### Scenario 1: Connecting the laser to a single computer using Ethernet connection.

- Optional: If the computer has a second Ethernet port or built-in wireless, the computer can access both the internet and the laser unit.
- The laser unit does not have access to the Internet (optional for Laser connection) unless the computer bridges/shares the Internet connection.

Note: The laser does have the option to set a Static IP address using the LCD software interface.

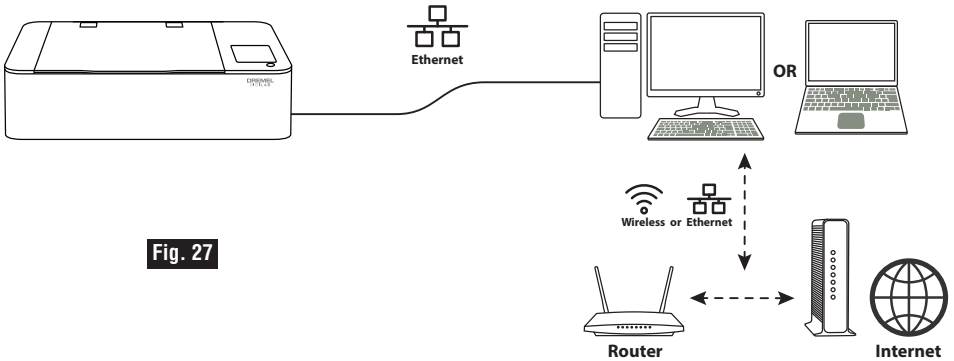

Fig. 27

#### Scenario 2: Connecting two or more laser units to a single computer using Ethernet connection.

A computer that has two or more Ethernet ports may connect to additional Laser Cutters.

- Optional: If the computer has an additional, separate Ethernet port or built-in wireless, the computer can access both the internet and the laser unit.
- The laser unit does not have access to the Internet (optional for Laser connection) unless the computer bridges/shares the Internet connection.

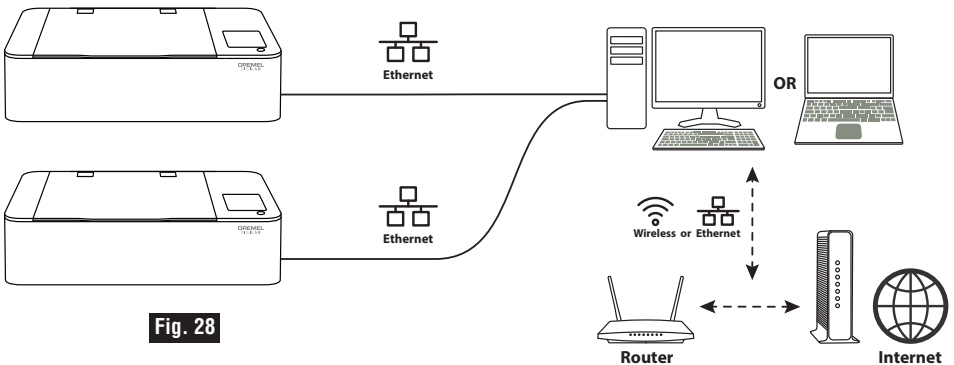

Fig. 28



# SETUP

## LOCAL AREA NETWORK (LAN) CONNECTION USING A ROUTER

### Scenario 3: Connecting the laser to one or more computers using a router with wireless and/or Ethernet Connection.

In this scenario, the user does have an Internet connection through the router.

One or more computers access the laser unit as well as the Internet through the Router.

The laser unit gets access to the Internet from Router.

Note: The laser does have the option to set a Static IP address using the LCD software interface OR the Router can assign a Static IP address.

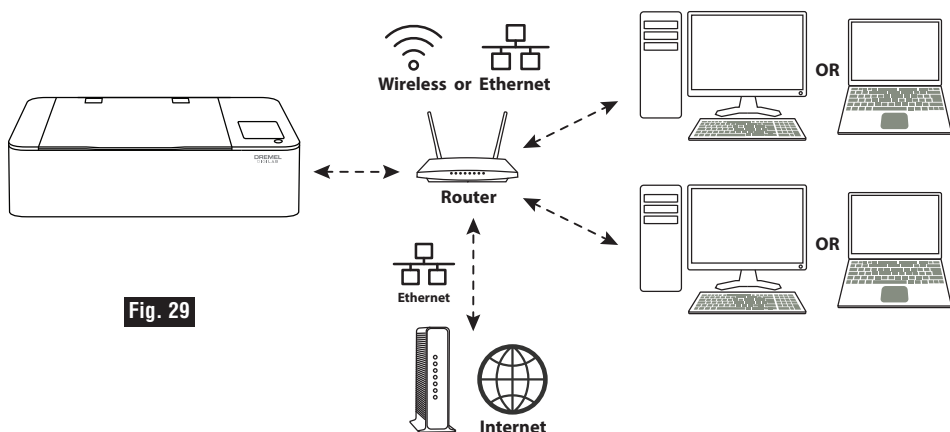

Fig. 29

### Scenario 4: Connecting two or more laser units to one or more computers using a router with wireless and/or Ethernet Connection.

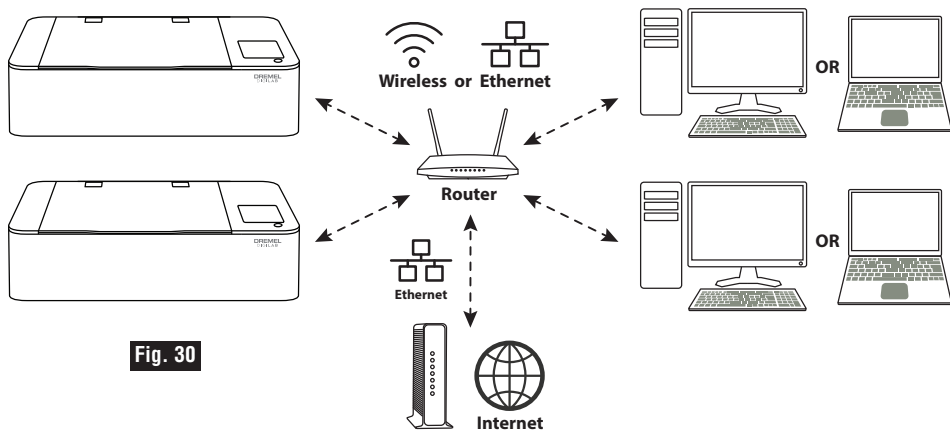

Fig. 30

## TESTS & ALIGNMENTS

**⚠ WARNING** Observe all provided warnings and safety instructions when using the Dremel LC40. Failure to do so may result in fire, equipment damage, property damage or personal injury.

### Mirror Alignment Overview

Alignment of the mirrors is performed before the Dremel LC40 is shipped. However, before the laser cutter unit is used for the first time and periodically during its use, the mirror alignment should be checked and adjusted if necessary.

Misalignment most often occurs when:

- gantry is manually moved while the motors are locked,
- air assist nozzle is displaced,
- main laser tube is replaced,
- mirrors / lens are replaced, or
- during shipping.

Alignment of the mirrors is necessary to be certain that the path of the main laser axis is perfectly parallel to both the Y and X axis of the laser in all extreme corners of the machine. Due to tolerance of the mechanical assembly, every laser must be aligned. The goal of alignment is that the laser beam should enter the lens as perfectly centered and perpendicular to the focus lens as possible. Improperly aligned laser beam will result in the focus point being out of line with the centerline of the laser head (Fig . 31).

**Fig. 31**

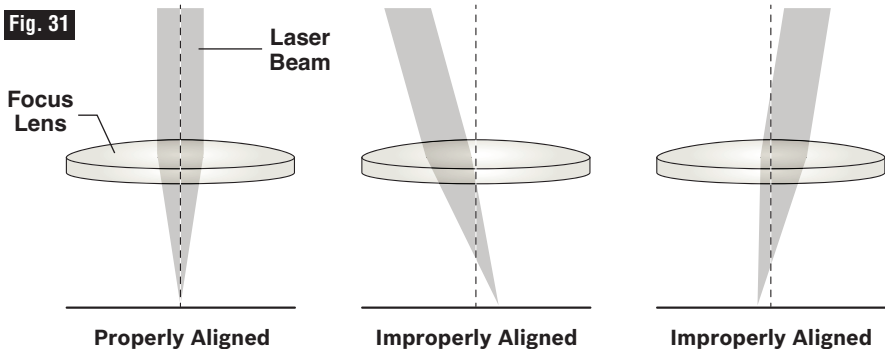

## TOOLS & SUPPLIES NEEDED FOR TESTS & ADJUSTMENTS

- 1.5 mm Hex Key
- 2 mm Hex Key
- 2.5 mm Hex Key (included)
- 3 mm Hex Key
- Alignment Paper (included)
- Wipes

## TESTS & ALIGNMENTS

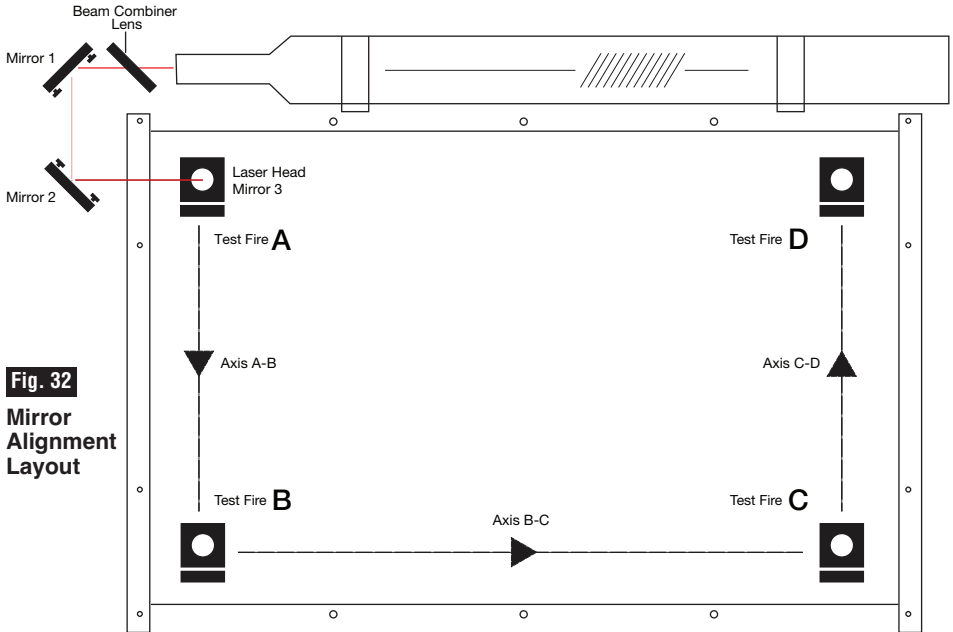

**Fig. 32**

### Mirror Alignment Layout

## 4 Corner Mirror Alignment Test

Before running the first job, check to make sure that the mirrors are properly aligned. This test should also be performed as a troubleshooting measure for power loss, clipping, or incomplete cutting. For this alignment test the laser must be “test fired” once in each corner of the machine. This is done to make sure the laser beam is following the correct path to the mirrors, to the focus head, and ultimately through the lens to the material. Figure 32, Mirror Alignment Layout.

Note: Laser lid must be closed for each test fire.

### Materials needed:

- Thermal paper (supplied).
  - 2.5mm hex wrench (supplied).
1. Open the lid.
  2. Place the thermal paper: Take a small piece of thermal paper approximately the same size as the face of the lens and place it over the focus lens under Mirror #3. See figure 33.

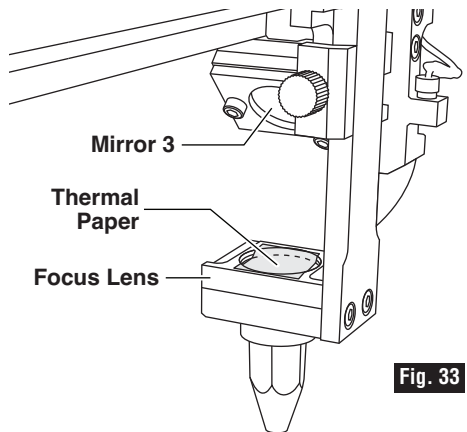
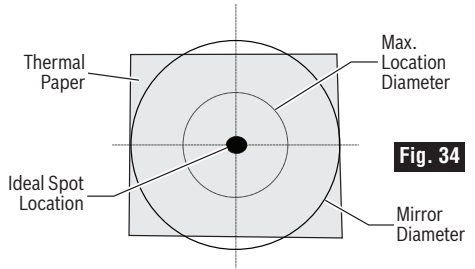



**Fig. 33**

3. Press the paper down with a finger so that a circle appears that demonstrates the outer rim of the lens. Sometimes pencil lead or crayon will help to show the edges of the lens and mirrors.

## TESTS & ALIGNMENTS

3. Position the Laser Head: Move the laser head into the upper left corner (Location A) of the workspace, see Figure 32.
4. Close the lid.
5. Using the LCD touch screen display, test fire the laser (by tapping **Test Fire on the Home screen**) from the Test Fire screen. The Fire button will appear after all of the system checks are passed. Press the button one time and observe where the spot lands on the thermal paper. If the spot does not appear, repeat. If it still does not appear, change position so it is possible to look through the openings in the tube guard and confirm that the tube is actually firing.
6. Repeat Test Fire in other three corners: Without removing the thermal paper, repeat firing the laser once in each of the other corners of the machine (Lower Left B, Lower Right C, Upper Right D). See figure 32.
  - a. Open the lid.
  - b. Position the laser.
  - c. Close the lid.
  - d. Repeat as in step 5. Observe which mark is from which location.
7. Check Results: With the forth corner test fire complete, open the lid and observe the thermal tape. The four burn marks should overlap each other (see illustration). If they do not overlap nearly perfectly, the mirrors will need to be aligned.
8. If the dot is perfectly aligned a second test is to place thermal paper under the air nozzle on the honey comb at all 4 corners. Fire the laser using test fire and verify that a smooth circle appears on the paper. This ensures that the air nozzle is not clipping the laser path. If it is, fine-tune the nozzle by loosening the set screw and adjusting.

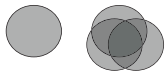

	
All 4 spots should be within the diameter shown in figure above. Ideally exactly on top of each other.	3 spots together, 1 spot apart indicates the gantry has one corner physically higher or lower than the others.

9. If the mirror alignment test is not successful then perform the Mirror Alignment Procedure on page 65
10. If the mirror alignment test is successful the laser cutter is ready for use.

# TESTS & ALIGNMENTS

## Mirror Alignment Procedure

---

### Steps:

1. Gantry Alignment
2. Preparation
3. Verify centering and no clipping at mirror #1
4. Align Axis A-B (Y-Axis) using Red Dot.
5. Align Axis B-C (X-axis)
6. Centering on focus lens. (Z-axis)

### Materials needed:

- Thermal paper (supplied). When supply is exhausted, purchase adhesive backed thermal paper.
- 2.5mm hex wrench (supplied).

### Step 1: Gantry Alignment

---

The first task of mirror alignment is to ensure that the gantry is perpendicular to the Y axis rails. Often misalignment occurs when the gantry is bumped or moved while the motors are in a locked state.

1. To verify alignment, push the gantry all the way forward until it contacts the front stops and backward until it contacts the rear stops.
2. The gantry should touch the stops at the same time on both the left and right side. If it touches evenly, move to Step 2: Preparation.
3. If The gantry does not touch both sides, the motor connector under the tube guard needs to be loosened.
  - a. Do this by removing 3 screws of the tube guard and lifting the tube guard up off of the posts. (see Tube Guard Removal, page 70)
  - b. Loosen the screw on the left side of the motor connector. Fig. xq.
  - c. Shift the gantry tight against the front stops and hold evenly.
  - d. Tighten the screw on the motor connector while holding the gantry.

- e. Replace the tube guard using great care not to damage any wires or the laser tube.
4. Rerun the 4 corners mirror alignment test to see if further alignment is necessary.

### Step 2: Preparation

---

Prepare your tools and workspace.

1. Power On Laser Cutter: The machine must be powered on to continue this procedure. Allow the machine time to boot up the touch screen operating system.
2. Gather Tools: A 2.5 mm hex wrench and a supply of thermal paper are required to perform the mirror alignment procedure

NOTE: DO NOT over-tighten or over-loosen adjustment screws, see figure wq. Tightening or loosening any of the three adjustment screws on the mirrors or the red dot diode will move the position in a particular direction depending on the positioning of the other screws. Some experimenting is required to understand the relationship of each screw and how adjusting one affects the alignment laser's red dot positioning. When adjusting the screws, use the absolute minimum turn of the hex wrench to move the red dot or the mirror into position. If one or two turns of the screw from the just seated screw position does not move the red dot into position, it is recommended to release all three screws back to the just seated position and start over. Over tightening the screws can damage the mirror holding plate. Check for any loose screws at either the mirror holders, the lens, or anywhere on the gantry. to ensure efficiency during alignment procedure.

## TESTS & ALIGNMENTS

### Step 3: Verify No Clipping at Beam Combiner and at Mirror #1.

1. Open the lid.
2. Place Thermal Paper: Take a small piece of thermal paper (approximately 1 inch (25 mm) should be plenty) and place it firmly over the beam combiner near the aperture side of the laser, see figure 36.
3. Press the paper down with your finger so that a circle appears that demonstrates the outer rim of the lens. Sometimes pencil lead or crayon will help to show the edges of the lens and mirrors.
4. Close the lid.
5. Using the touch screen display, test fire the laser from the Test Fire screen. The Fire button will appear after all of the system checks have passed. Press the button one time and observe where the spot lands on the thermal paper. (From here forward called \*Test Fire\*)
6. The spot should be centered on the beam combiner. Remove the thermal paper.
7. Repeat steps 2 – 5 at Mirror #1 (Fig. 37).
8. The spot should be nearly perfectly centered at Mirror #1 and not clipped by the beam combiner. If it is not, there is a problem with the tube mounting as there is very little to adjust between the tube and the mounting of Mirror #1.
9. Remove the thermal paper and clean all tape residue from the beam combiner and Mirror #1.

Fig. 36

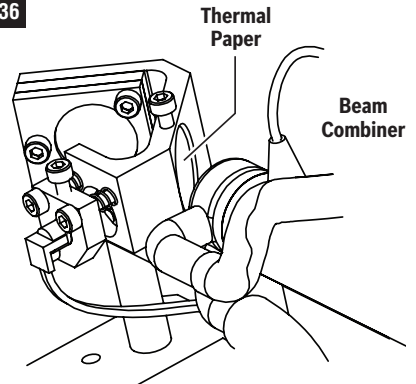
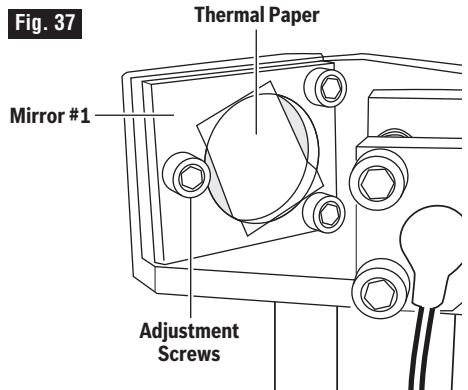
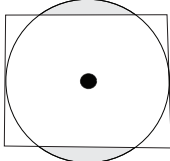



Fig. 37



	
Spot should be centered.	Clipped spot indicates an alignment issue.

## TESTS & ALIGNMENTS

### Step 4: Align Axis A-B (Y-Axis) using Alignment Laser's Red Dot.

Conceptually, you will be aligning the invisible cutting beam and the Alignment Laser's visible red dot with the axis of the shaft from A to B. When the beams are perfectly parallel with the A-B axis, do not continue to change Mirror 1. Further changes to Mirror 1 will then negate the alignment to the axis.

1. Open the lid.
2. Place Thermal Paper: Take a small piece of thermal paper (approximately 20 mm should be plenty) and place it firmly over Mirror #2, see figure 38.
3. Press the paper down with a finger so that a circle appears that demonstrates the outer rim of Mirror #2. Sometimes pencil lead or crayon will help to show the edges of the lens and mirrors.
4. Move the Gantry to position B, see figure 32.
5. Close the lid.
6. \*Test Fire\* Observe where the spot lands through the lid. Without removing the paper it may be necessary to mark this spot. This is SpotB1.
7. Adjust only the visible red dot to match the spot.

Do not move the gantry at this time, and do not adjust Mirror #1 yet. Using the 2.5mm hex wrench, make micro adjustments to the three adjustment screws of the alignment laser, and position the red dot exactly over the burn mark at position B on Mirror #2. If the red beam is not hitting the mirror at all, it may be necessary to use a larger card or paper to determine where the red dot is. Go slowly and do not overtighten screws. Small turns of the screws are required to move the beam at long distances. It is best to align the red dot at the furthest distances B and C to avoid small angle issues introduced at A or D.

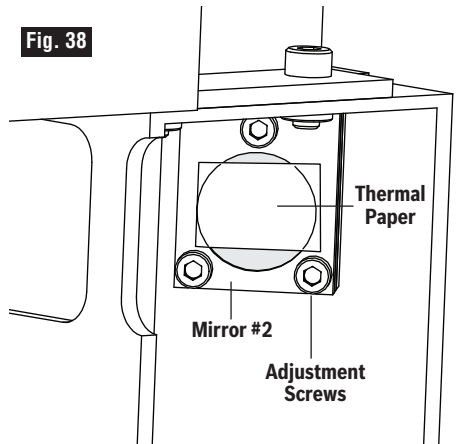

8. Without removing the paper, move the gantry to A.
9. \*Test Fire\*. If possible change position to see if the test fire lands on the thermal paper without opening the lid. If it is not possible it may be necessary to use the suggested marks in step 6. This is SpotA1
  - a. If the two marks are exactly on top of each other,
    - i. then the Y axis is aligned. Do not make any more changes to M1
    - ii. Move on to B-C X axis alignment.
10. If the 2 dots are not on top of each other at A and B, continue as follows:
  - a. Move the head back to position B.
  - b. Note that the red dot can now be used to predict where the next laser fire shots will be if it is aligned as in 7a.
  - c. While at position B, slowly adjust Mirror 1. Not the red dot! See Note Z above.
  - d. Change the mirror so that the red dot moves halfway toward spotA1.
  - e. Leave the gantry at B, Close the lid and tap \*Test Fire\*.
  - f. The new SpotB2 should have moved toward SpotA1 and match the red dot.

## TESTS & ALIGNMENTS

- g. If the red dot does not match the new SpotB2, tweak the red dot (not M1) as in step 7.
  - h. Move the gantry to A, close the lid and \*Test Fire\*. Observe the new SpotA2. It should be only a little closer to SpotB1.
  - i. Note: If at any time spots become confusing, shift the paper or remove it completely and start with a clean piece. Spots will have to be redone and \*Test Fired\* at both A and B.
  - j. Continue this cycle of:
    - i. Fire Spot B,
    - ii. tweak the red dot,
    - iii. Fire Spot A,
    - iv. adjust M1 while the gantry is at B
    - v. until the spots created are perfectly on top of each other. The spots on M2 may not be perfectly centered, but should certainly not extend off of the edge of M2.
5. Close the lid and tap \*Test Fire\*. Without removing the paper it may be necessary to mark this spot. This is SpotC1.
  6. Adjust only the red dot beam to match the SpotC1. As this is the furthest distance it will take extremely small movements of the screws to move the red dot.
  7. Move the head back to position B.
  8. Close the lid and tap \*Test Fire\* observing and marking the spots as necessary. This is SpotB1.
  9. As before if SpotC1 and SpotB1 are not exactly on top of each other adjust the red dot using Mirror2 this time to adjust the location of the red dot half way to SpotB1.
  10. See steps above and repeat this cycle of:
    - i. Fire Spot C,
    - ii. Tweak the red dot,
    - iii. Fire Spot B,
    - iv. adjust M2 while in position C.
    - v. until the spots created are perfectly on top of each other. The spots on M3 may not be perfectly centered, but should certainly not extend off of the edge of M3.

### **Step 5: Align Axis B-C (X-Axis) using Alignment Laser's Red Dot.**

Alignment of the B-C axis is often much easier than the A-B axis due to proximity of the gantry and experience learned on the first axis. It cannot be stressed enough that the A-B axis should be aligned before attempting to align the B-C. As with A-B and M1, once B-C is aligned, do not continue to adjust M2. Further adjustment of M2 will negate the alignment of B-C.

1. Open the lid.
2. Place Thermal Paper as before on Mirror 3.
3. Move the Gantry to Position C.
4. Note that it is possible that Mirror 2 can be adjusted far enough out of range and potentially damage the rubber of Mirror 3 when the laser is fired. Look for the alignment Laser. It



## TESTS & ALIGNMENTS

### Step 6: Align Axis Lens holder (z-Axis) using Alignment Laser's Red Dot.

Centering of the beam on the lens is the most critical component of alignment. However, as the distance from M3 to the lens is very short, it is difficult to make drastic changes to the position of the laser spot. Resist the urge to adjust M2 or M1, because as indicated before, it will only create misalignment.

1. Open the lid.
2. Place Thermal Paper: Take a small piece of thermal paper (approximately 20 mm should be plenty) and place it firmly over the lens.
3. Press the paper down with a finger so that a circle appears that demonstrates the outer rim of the lens. Sometimes pencil lead or crayon will help to show the edges of the lens and mirrors.
4. Move the Gantry to Position C.
5. Move the lens to its lowest position using the focus puck on the honeycomb.
6. Close the lid and tap \*Test Fire\* Without removing the paper as it may be necessary to mark this spot. This is SpotL1.
7. Tweak the red dot to match the spot on the paper. Due to the reflections of all of the mirrors the red dot may not move with the same screw turns as it did previously.
8. Adjust Mirror 3 continuing to test fire until the spot is nearly perfectly centered.
  - a. Note: do not overly tighten Mirror 3.
  - b. In rare instances, it may be necessary to access the Mirror 3 mounting screws.
  - c. Fully remove the lens holder assembly by loosening the thumbscrew.

- d. Loosen the two Mirror 3 mounting screws enough to rotate the lens in the direction of the missing shot. While holding the lens, retighten. The screws tend to rotate the mirror in the direction of tightening.

- e. Replace lens holder assembly.

9. After the spot is centered rerun the 4 Corners Tests. The spots should now be nearly on top of each other. Also be sure to check that the nozzle is not clipping the laser patch and adjust if necessary.

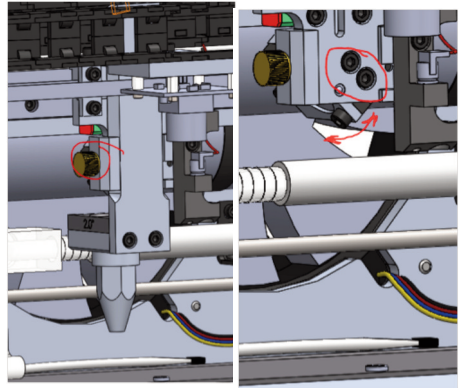

## TUBE GUARD REMOVAL

**⚠ WARNING** Observe all provided warnings and safety instructions when using the Dremel LC40. Failure to do so may result in fire, equipment damage, property damage or personal injury.

**⚠ WARNING** Disconnect the plug from the power source before making any assembly, adjustments or changing accessories. Such preventive safety measures reduce the risk of starting the Laser Cutter accidentally.

**⚠ WARNING** Do not touch the any part of the laser tube and its connections. Laser tube and its connections may be hot if laser was used recently.

**⚠ CAUTION** Use care when removing the tube guard. The LED lights may be damaged by contact with tube guard edges.

For some tasks, the Tube Guard requires removal so that components can be accessed. Examples are Gantry alignment (motor connector adjustment), fan cleaning, and laser tube replacement. If removal is required, follow the steps below.

1. Move the gantry to it's furthest forward point, Fig. 36.

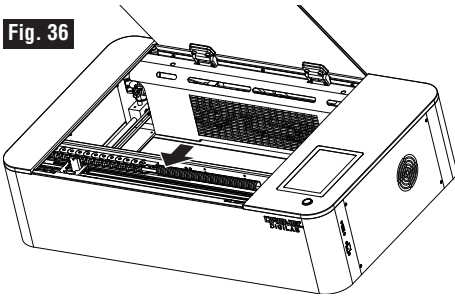

2. Loose the 3 captive fasteners of the guard, Fig. 37.

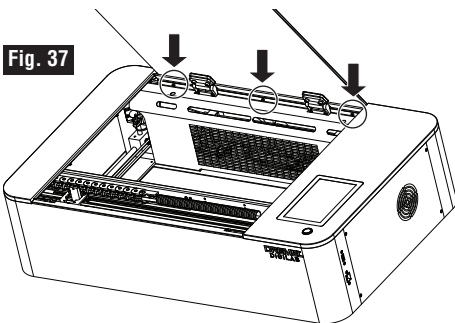

3. Lift the guard slightly off of the posts that retain the bottom of the guard.

4. Rotate the guard counter clockwise as shown in fig 38.

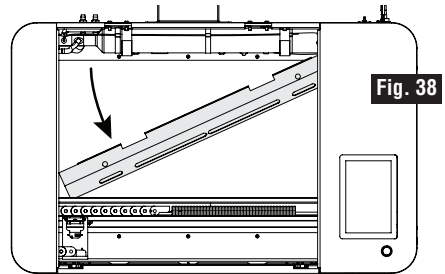

5. Lift the front left corner of the guard until it clears the plastic, Fig. 39. Use caution not to damage the LED lights. Continue to tip and rotate.

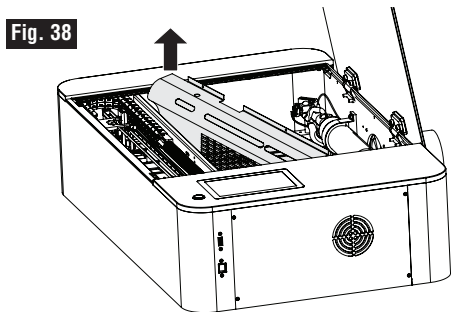

Reverse steps to install.

## OPERATING THE LASER CUTTER

**⚠️ WARNING** Observe all provided warnings and safety instructions when using the Dremel LC40. Failure to do so may result in fire, equipment damage, property damage or personal injury.

**⚠️ WARNING** Your laser cutter must be properly vented to the outside at all times. Do NOT operate unless properly vented as set forth in the owner's manual or these instructions.

**Failure to follow all instructions could result in property damage, personal injury or death.**

**⚠️ WARNING** Always use a properly configured, installed, maintained, and operating fume/smoke exhaust system as recommended by the manufacturer when operating the laser system. Caustic fumes and smoke from the engraving process must be extracted from the laser system and exhausted outside.

**⚠️ WARNING** Always inspect the exhaust fan and duct work for obstructions and ensure proper air flow exists before each use. Unobstructed and properly maintained exhaust fan and duct work will reduce the risk of fire and effectively extract caustic fumes and smoke.

**⚠️ WARNING** Never engrave or cut any unknown material. Only engrave materials recommended by the manufacturer. The vaporization/melting of many materials, including but not limited to PVC and polycarbonates, can give off hazardous fumes. Always refer to the Safety Data Sheet (SDS) from the material manufacturer to determine the response of any work material to extreme heat (burning/fire hazard) to prevent hazards.

This product uses a laser beam to rapidly heat, melt and partially or completely vaporize the material, creating a number of gases and particulate matter. These byproducts of laser operation can, in some cases, pose health risks to those exposed to them.

To reduce or minimize exposure to their health hazards, always use an appropriate filtration and/or exhaust system and carefully choose your material. When using materials other than those suggested by Dremel, ask the manufacturer for the SDS (Safety Data Sheet) for each material. The SDS "Hazards Identification" section will provide information to help determine if the material or it's by products are harmful. If the material does not have an SDS, consult the manufacturer to determine if the material generates toxic gases and/or dust, and if it presents fire or explosion hazards.

Representative materials listed in table 1 have been tested and with a properly installed and maintained exhaust/filtration system, levels are below current occupational standards. (See [www.-----](http://www.-----) for material specifics?). The commonly used materials in table 1 can vary in composition depending on manufacturer and other factors. Dremel has not tested all possible combinations and not all materials have documented health effects of materials in use. As such, the user is responsible for material choice and subsequent health consequences.

The Laser engraver has an exhaust port, fan and ducting which is a means to remove byproducts created during laser operation. Always ensure the exhaust is functioning. Refer to page XX for proper venting configurations. Exhaust and filtration systems may not be able to remove all hazardous substances or reduce their concentration to acceptable levels, so never use materials that are prohibited (see table 2). When used with a properly operating exhaust/ filtration system, cutting/engraving the suggested materials have not shown elevated levels of toxic emissions but as more data becomes available, this may change. Always check [www.currentmaterialsTBD.com](http://www.currentmaterialsTBD.com) for the latest material information.

## OPERATING THE LASER CUTTER

### **Laser Cutting / Engraving Prohibited Uses & Restrictions**

The laser cutter may be used only for lawful purposes. Dremel does not recommend nor endorse the use of the laser cutter to create material that is:

- i. Prohibited by local, state or federal law;
- ii. Unsafe, harmful, dangerous, poses an immediate threat to the well-being of self/others, or is otherwise inappropriate for the environment; or
- iii. In violation of another's intellectual property rights. For example, the laser cutter will not be used to reproduce material that is subject to copyright, patent or trademark protection.
- iv. Used as a structural component - The use of parts made must be thoroughly evaluated by a competent professional prior to being included in such structure.
- v. In contact with or consists of food; Prior material use may transfer and contaminate food.

Do not attempt to cut or engrave human or animal tissue.

## OPERATING THE LASER CUTTER

Before the laser can be used, an actual project must be created. The project is then sent to the laser as a job and fabrication begins. When done, a part is ready for removal from the unit. The following steps cover the process from beginning to end.

Sequence of Operations:

- 1) Create a Project.
- 2) Place work piece on the honeycomb plate.
- 3) Focus the Laser Head.
- 4) Send the job to the Laser.
- 5) System check.
- 6) Run the Job.
- 7) Finishing the job.

### Step 1: Create a Project

Projects are constructed by opening the workspace in the Dremel LC40 Control Software and importing a file (or files). The files are available from (3) sources:

- A) Creating them in a graphics program.
- B) Importing previously created files.
- C) Using the camera capture feature.

Most files are created through the use of software such as CorelDRAW®, Adobe Illustrator® or other graphic software. Depending on the software and how the file was created, a project is developed to run a job that will allow the laser to cut, engrave and/or score the material. Table 3 below lists several file types which can be imported into the Laser System software. Please refer to the 3rd party software manufacturer's instructions regarding creation of vector or image files.

Extension	File Type	Laser Process		
		Cut	Engrave	Score
.SVG	Vector	X		X
.PDF	Vector/Image	X	X	X
.JPEG	Image		X	
.PNG	Image		X	

## OPERATING THE LASER CUTTER

### Source A) & B) File Preparation Details

Most designers use software such as Corel Draw® or Adobe Illustrator® to create the design files to import into the Dremel LC40 Control software, but pictures that have been taken with a camera can also be used. Any software can be used that exports PNG, JPEG, PDF, or SVG files.

The Dremel software accepts both vector (SVG or PDF) and image (JPEG, PDF, PNG) based files. It's best to think of "cut" and "engrave" separately when designing for the Dremel Digilab Laser Cutter. Vector file types are optimal to cut something out of a material, or trace along lines with the laser. Image file types are optimal to engrave into the surface of a material with various levels of intensity.

In order to use the file created in the design software, simply "save as" or "export" your file as one of the above file types. It's best to save parts of the file that will have applied different laser settings or applications to, as different files before importing.

By default, the Dremel software will recognize different colors in vector files and allow the application of different settings based on those colors. For a single image file, the same print settings need to be applied to the entire file.

For example, to engrave the dark area in this image in a dark shade, and the white in this image in a light shade, it would be best to export the dark area and the white text and circle outline as two separate files:



dark engrave (image file) + light engrave (image file) = light and dark engrave

(a similar output could be obtained by bringing in a single image file and applying "grayscale". In this case, however, the engraving will fill the object with tiny dots, rather than appearing solid.)

Similarly, to engrave the dark area and cut out the white text, it would be best to save the text outline as an SVG or PDF and the dark area as an image file:



dark engrave (image file) + text outline (vector file) = text and circle cut out

Multiple files can be sent to the laser as a single job. Simply import multiple files. If multiple files are exported from the same source file, the Dremel software will place them on top of one another by default.

# OPERATING THE LASER CUTTER

## Source C) On-board Camera Capture

There are two ways to use the camera capture feature. The first way is to use the camera to pull a picture of the material into the background of the software. Being able to see the size and location of the work piece in the software helps with aligning imported files, and reduces wasted materials. This is especially useful when wanting to cover the entire surface, to place a file in an exact location (center, near an edge or corner, etc), or if it is a small piece of material.

In order to use this function (Option 1):

1. In the Dremel LC40 Control software, go to IMPORT menu. Click on IMPORT>CAPTURE.

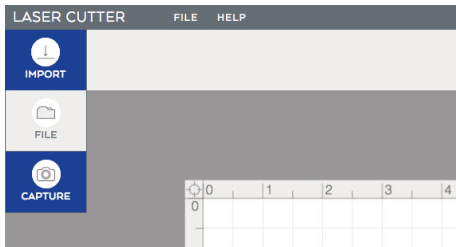

2. Follow the on screen instructions – Place the material onto the center of the honeycomb plate and close the lid. Click “NEXT”.

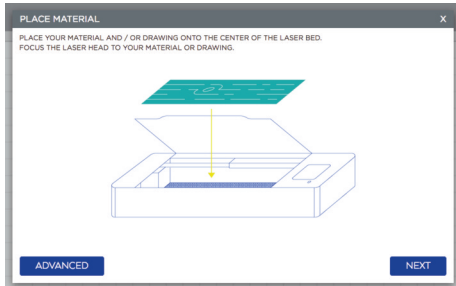

3. The LED lights in the laser will flash off, and a red dot will appear. If the red dot is not on top of the work piece, adjust the work piece and start again with step 1.

4. The camera will then capture 9 different images of the bed and stitch them together.

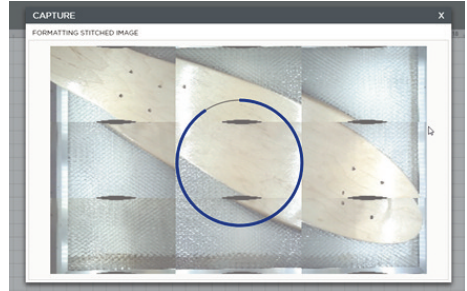

5. Click “Done” to place this image into the background of the workspace.

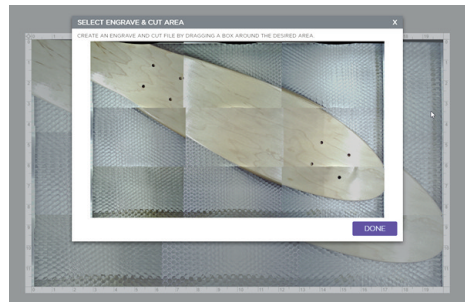

6. The background image can be cleared at any time by going to Import>Clear Capture.

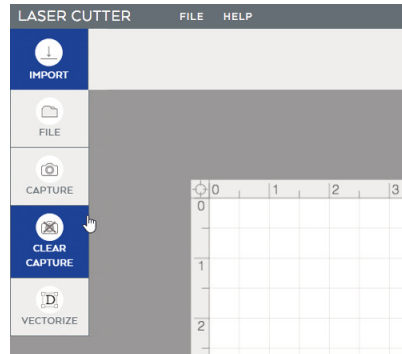

## OPERATING THE LASER CUTTER

The second way to use the camera capture is to trace a drawing or sketch. For this application, it's best to use a black marker on white paper.

Steps 1 - 4 are the same as in the previous capture method.

Follow steps 1 - 4 on previous page.

5. Drag a box around the area of the sketch that will be turned into a laser file. Choose to make the selection sensitivity higher or lower by switching between the 3 threshold options and click "next."



6. Choose whether the file will be engraved or cut, and whether the background image should appear in the software by toggling the switches on or off and then click "done".

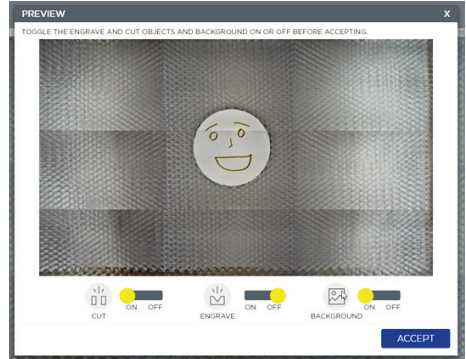

7. The background image can be cleared at any time by going to Import>Clear Capture. The cut or engrave files can be cleared by hitting "delete" on the keyboard.

## Import Project Files

Once the project file(s) are created they can be imported into Dremel LC40 and executed.

1. Import, drag and drop a file, or use the camera capture to begin a project.

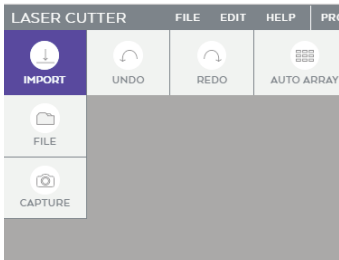

Import PDF or SVG files for objects you would like to cut or score.

Import JPEG, PNG, or PDF files for objects you would like to engrave.

More than one object can be sent to the laser in a single job by importing multiple objects into the same workspace.



## OPERATING THE LASER CUTTER

2. Select the material type and thickness. The material library will automatically populate suggested cut and/or engrave print settings based on the material and thickness selected.



3. Move, scale, and adjust objects to the desired orientation. More precise adjustments can be made in the bottom left side of the screen.

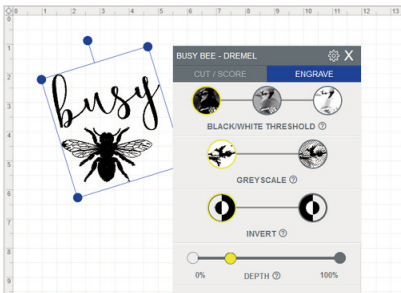

4. Adjust print settings as needed. If the settings are changed in this box, they will override Dremel recommended settings until a new material is selected. The top right side of the print settings box will unlock more precise setting options. Review job and job execution order to make sure the desired result.

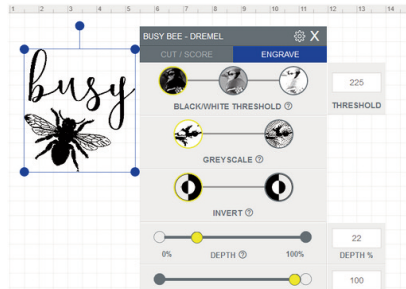

5. Send the job to the Laser.

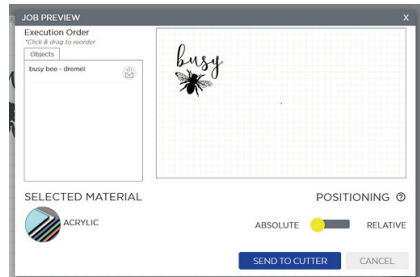

If you would like to save a job to your computer to repeat again later go to File/Save. The job will be saved in a .bin format and will contain each object, it's location, and it's print settings.

## OPERATING THE LASER CUTTER

### Step 2: Place Material on the Honeycomb Plate

**⚠ WARNING** Observe all provided warnings and safety instructions when using the Dremel LC40. Failure to do so may result in fire, equipment damage, property damage or personal injury.

**⚠ WARNING** Never engrave or cut any unknown material. Only engrave materials recommended by the manufacturer. The vaporization/melting of many materials, including but not limited to PVC and polycarbonates, can give off hazardous fumes. Always refer to the Safety Data Sheet (SDS) from the material manufacturer to determine the response of any work material to extreme heat (burning/fire hazard) to prevent hazards.

**⚠ WARNING** Always use provided work piece support structure. Fabrication without honeycomb support may lead to fire or release of stray radiation.

**⚠ WARNING** Do not use irregularly shaped work piece. Risk of stray radiation or fire.

**⚠ WARNING** Do not stack work pieces. Stacking work pieces increases the risk of fire.

Place the work piece inside the laser on the honeycomb plate, Fig. 39. Always place the work piece on the honeycomb plate for cutting jobs. For engraving or scoring thicker pieces of material, the honeycomb plate can be removed and the work piece placed directly placed on the surface that supports the honeycomb plate. If it is an irregularly shaped work piece (such as a circle), place the work

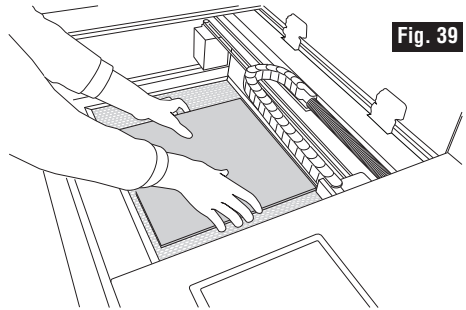

piece anywhere on the laser bed and use the camera capture feature in the Dremel LC40 Control software to align the design with the work piece. Be careful not to damage any part of the machine during this process. The laser head can be moved out of the way by hand if necessary, by pressing the “unlock” button on the LCD touchscreen.

Make sure the work piece sits flat on the honeycomb plate. If the work piece is not flat, the Laser beam will be out of focus. If the difference in flatness of the lowest spot to the highest spot or your work piece is more than 1/8" the Laser head could touch or move the work piece out of position. Depending on the job, the work piece can be aligned with the top left corner of the honeycomb plate, or placed at any location on the honeycomb plate.

## OPERATING THE LASER CUTTER

### Step 3: Focus the Laser Head

The bottom of the laser head must be at the correct distance from the top surface of the work piece in order to cut or engrave a clean image.

To focus the laser head (Fig. 40):

1. Move the laser head so that it hovers over your work piece, either by pressing the arrow buttons on the LCD touchscreen, HOME menu, or by pressing “unlock” and moving the laser head manually with your hand.
2. Loosen the laser head knob (left hand side of the focus lens). Loosening the knob frees up the focus lens to move up and down.
3. Raise the laser head and place the spacer puck between the laser head and the work piece.
4. Let the laser head rest on the spacer puck and tighten the laser head knob to fix the laser head in place.
5. Remove the spacer puck.

Note: If the work piece to be engraved is too thick to fit in the laser with the honeycomb plate, remove the honeycomb plate and place the work piece directly on the surface that supports the honeycomb plate. However, this is only recommended when engraving. Do not do this if the material needs to be cut.

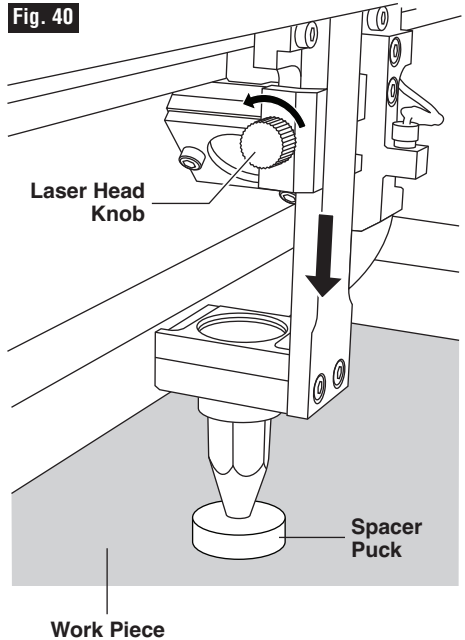

# OPERATING THE LASER CUTTER

## Step 4: Send the Job to the Laser

Close the laser lid. The “Run Perimeter” feature on the LCD laser screen or in the Dremel LC40 Control software can be utilized to ensure that the work piece and the design are aligned. The “Run Perimeter” feature moves the head of the laser around the perimeter of the job as it is set up in the software.

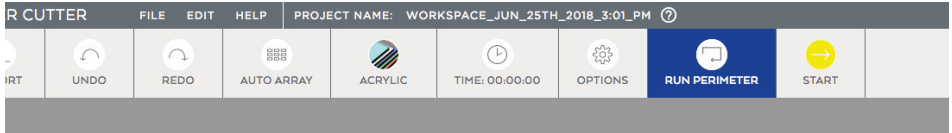

Send the job file to the laser so the laser can perform its system checks. From the Dremel LC40 Control Laser Software toolbar click "START" to run the job.

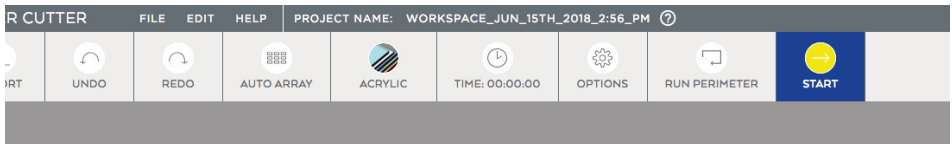

## Step 5: System Check

Review the screen to make sure that all four system icons are white indicating the system is ready to run.

If any icons are red, the laser will notify you that these systems need to be fixed before beginning the job. A “?” next to the appropriate line item will help to diagnose and correct each error.

Refer to Touch Screen information starting on page 19 for additional information.

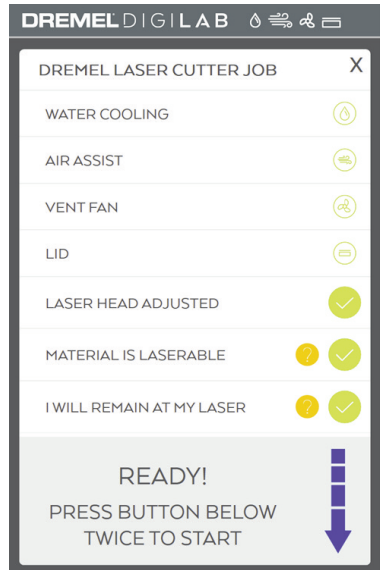

## OPERATING THE LASER CUTTER

### Step 6: Send a Job

---

**⚠️ WARNING** Do not operate when access door is open. An open door can lead to stray radiation, increased exposure to hazardous vapors or burn hazard."

**⚠️ WARNING** Never operate the laser cutter system without constant supervision of the cutting and engraving process. Exposure to the laser beam may cause ignition of combustible materials and start a fire.

**⚠️ WARNING** Always use the air assist as recommended by the manufacturer, especially while cutting. Cutting movements are relatively slow and apply an extremely large amount of heat to the work piece. Avoid the build-up of heat in order to reduce the risk of fire.

**⚠️ WARNING** Always use a properly configured, installed, maintained, and operating fume/smoke exhaust system as recommended by the manufacturer when operating the laser system. Caustic fumes and smoke from the engraving process must be extracted from the laser system and exhausted outside.

See the software section of the manual to learn how to create a project and send a job.

When the project is ready to be sent to the laser, press the "start" button on the LCD to send the job to the laser.

Ensure tools and parts such as spacer puck, wrench, debris, etc. are removed from the honeycomb plate before starting a laser job.

On the laser screen, verify that all system warning icons are still white.

The "Run Perimeter" feature on the LCD laser screen or in the laser software can be utilized to ensure that the material and the design are aligned. The "Run Perimeter" feature moves the head of the laser around the perimeter of the job as it is set up in the software.

It is also possible to "Test Fire" the laser from the XYZ to make sure that the laser is firing properly.

If after test firing the laser and potential solutions are to clean the mirrors and lenses or re-align the mirrors. Consult the maintenance and troubleshooting sections of this manual for more detail.

Double click the button on the laser LCD screen to start the job!

### Step 7: Finishing the Job

---

Once the job is complete the finished part and the remaining material, can be removed from the laser.

1. Verify that the laser head is not firing and has stopped moving before opening the lid.
2. Open the lid to get access to the parts.
3. If the laser head is above the part, you can unlock it by pressing the "Unlock"

button on the LCD HOME screen and then move the head to the top left corner by hand.

4. Carefully remove all pieces from the honeycomb plate. Be careful not to damage any part of the unit during this process.

## MAINTENANCE

**⚠ WARNING** Observe all provided warnings and safety instructions when using the Dremel LC40. Failure to do so may result in fire, equipment damage, property damage or personal injury.

**⚠ WARNING** Disconnect the plug from the power source before making any assembly, adjustments or changing accessories. Such preventive safety measures reduce the risk of starting the laser cutter accidentally.

### Water Tank Maintenance

1. Change water every 30 days to remove particles and compensate for evaporation.
2. Check water level daily. Remove cap to check water level. Add distilled water if needed.
3. Check to verify water is circulating by removing the cap to the water bottle. Check daily.
4. Check for mold. Must be cleaned with bleach if mold develops.

### Cleaning

Clean every 4 to 5 hours of use or once per day. Material that produces larger amount of smoke, such as wood, cleaning is recommend more frequent. Use extreme caution when cleaning the lens. If any scratches or pitting can be seen on the surface, the lens must be replaced. These imperfections reduce power and will result in less energy reaching the work piece.

Any contaminant left on the lens will result in the debris absorbing more energy, which can damage the lens surface.

#### Materials needed for cleaning mirrors and lenses:

- Finger cots or latex/vinyl gloves, powder free.
- Cotton tipped swabs or lens wipes with alcohol free solution.

#### Procedure for cleaning the focus lens:

1. Remove the lens from the lens holder, see figure 41.
2. Dip the swab or lens wipe in the lens cleaner solution, use a gentle circular motion to clean the lens surface.

Fig. 41

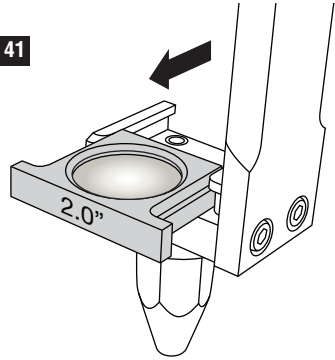

3. Use dry swabs or wipes to gently dry the lens surface.
4. Reassemble the focus lens in the lens holder

#### Procedure for cleaning mirrors:

**⚠ CAUTION** Never remove the mirrors for cleaning!

Take extra caution to not move the orientation of the mirrors as this will affect laser beam alignment and would require time intensive laser beam realignment.

The materials needed are the same as for the lenses.

Remember to check alignment after cleaning the mirrors, especially if they have been removed for cleaning. All the same precautions apply as for cleaning the lenses.

#### Procedure for cleaning the laser tube lens (Lens 1):

This lens is located at the output end of the laser tube and should be cleaned once every two months.

Be extra cautious when cleaning this lens. It cannot be removed from the laser tube. Any damage to the lens results in a damaged laser tube.

## MAINTENANCE

Use the same procedure as cleaning the focus lens.

### Procedure for cleaning the beam combiner lens.

For location of the beam combiner lens, refer to figure 2, page 18.

1. Cleaning the beam combiner lens requires removal of the laser tube shroud. See page 69 for removal of the shroud.
2. Do not remove the beam combiner lens.
3. Dip the swab or lens wipe in the solvent. Use a gentle circular motion to clean the lens surface.
4. Use dry swabs or wipes to gently dry the lens surface.
5. Reassemble the laser tube shroud.

Fig. 42

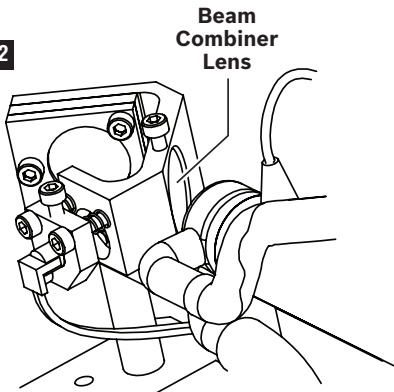

### Guide Rails X and Y

- a. **Clean the X and Y guide rails weekly.** Clean more often if debris is visibly accumulating.

Its important to keep the left and right side rails clean to allow the moving parts of the laser to glide freely without sticking or binding. Also, clean the guide rail between the two side rails supporting the moving gantry. Keeping these rails clean is important to maintain the high precision of the laser.

- b. **Use a clean soft cotton cloth to wipe down the rails.** Re-lubricate with a light coating of white lithium grease.

### Enclosure and Top Cover

The enclosure and glass lid for the laser should be cleaned at least monthly.

#### Cleaning the enclosure:

- Wipe down the external surfaces of the enclosure with a soft cotton towel. Use light pressure to avoid scratching the surface.
- Cleaning the glass lid and side covers.

Use glass cleaner and a soft towel to clean the lid.

The plastic side covers should only be cleaned with glass cleaner or a mild soap solution. Use a soft towel and light pressure. Do not use a paper towel, as this is more abrasive and can scratch the surface. Do not use alcohol to clean the plastic side covers.

- Use caution when cleaning the display screen as it is made of glass. Use light pressure.

#### Cleaning the interior:

The interior of the laser unit should be kept clean of debris. Check at least once per week and clean if necessary. Keeping the interior clean will reduce the risk of particles flaming during use. Moreover, reduce the chance of airborne dust interfering with the laser path.

- Remove the honeycomb plate and wipe or vacuum the interior of any debris.
- Pay particular attention to the laser tube cover as the small outlet openings can become clogged with debris.

### Y-Axis Belts

- a. **Checking belt tension.** Check the rubber belts for tension every six months. The rubber belts work together to move the gantry front to rear. Its important that they have relatively the same amount of tension. Tension is difficult to measure but there should not be sagging in one belt

## MAINTENANCE

**⚠ WARNING** Observe all provided warnings and safety instructions when using the Dremel LC40. Failure to do so may result in fire, equipment damage, property damage or personal injury.

and complete tension in the other. Dremel lasers are delivered with the proper amount of belt tension. It is advisable to check belt tension when the laser is new to establish a good baseline for future reference. Simply depress the belt lightly with your fingers and note the deflection. The belt should deflect about 1/4-1/2 inch with a light force.

- b. Tensioning the belt.** Loosen the idler pulley set screw. Pull on the Y idler pulley mount by hand. Moderate to strong force is recommended. Tighten the idler pulley set screw. Repeat for opposite side belt.

### Exhaust Fan

**⚠ WARNING** Do not try to clean exhaust ducting. The high concentration of particles may become airborne and create inhalation exposure.

#### **a. Clean the exhaust fan and exhaust shroud.**

After prolonged use, the fan performance can diminish due to dust build up on the fan blades and plenum. If the laser has been used for a lot of woodcutting, cleaning will need to be done more frequently. Debris can stick to any surface in its path. If fan noise or vibration is detected, a good cleaning is overdue.

Remove the flexible exhaust hose from the exhaust shroud. With a clean soft cloth, wipe the inside of the shroud to remove all residue.

Inspect the flexible duct for debris. If the diameter appears to be constricted, replace exhaust duct with a UL181 listed product.

With a soft cloth, clean the dust off the fan blades. It will be necessary to remove the fan from the enclosure.



## SHIPPING AND STORAGE

**⚠ WARNING** Observe all provided warnings and safety instructions when using the Dremel LC40. Failure to do so may result in fire, equipment damage, property damage or personal injury.

**⚠ CAUTION** Two person lift required. Lifting the laser cutter alone may result in personal injury.

### Shipping the Laser Cutter

Refer to the unboxing section on page 14 of the manual for help in returning the LC40 to its original packaging configuration.

1. Unplug and wind up the power cord.
2. Unplug the hex box connector cord.
3. Disconnect the Ethernet cable.
4. Disconnect the air tube.
5. Disconnect the exhaust hose by loosening the hose clamp.
6. Drain the cooling water. Place the hex box in a suitable container to capture the system water. Place the container in a location below the LC40. Remove the cap from the water tank. Disconnect the clear inlet water hose from the hex box and allow the water to drain. This will drain the water from both the hex box and the LC40 laser tube. It is important to drain as much water as possible in case of freezing weather. Tilting the hex box back and forth will help drain the water.
7. If shipping the LC40 in its original carton. Remove the 4 screws securing the exhaust shroud and place the exhaust shroud in its carton.
8. Remove the honeycomb plate and place it in its package.
9. When placing the LC40 in its original carton try to replace the foam pads in the order they came out. It is important the foam pads securely capture the gantry system. Secure the gantry with plastic ties to minimize any movement of the gantry during transportation.
10. Return the hex box to its original shipping location inside the laser enclosure. If it cannot be placed inside, it must be secured to the pallet outside of the laser.

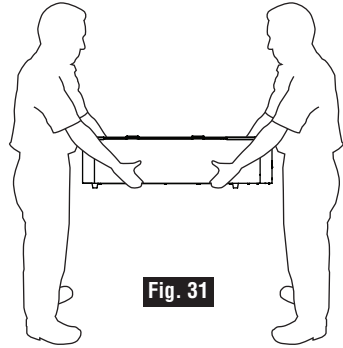

Fig. 31

11. When shipping the LC40 the unit must be secured to a pallet to prevent damage

### Storing the Laser Cutter

1. Unplug and wind up the power cord.
2. Unplug the hex box connector cord.
3. Disconnect the Ethernet cable.
4. Disconnect the air tube.
5. Disconnect the exhaust hose by loosening the hose clamp.
6. Drain the cooling water. Place the hex box in a suitable container to capture the system water. Place the container in a location below the LC40. Remove the cap from the water tank. Disconnect the clear inlet water hose from the hex box and allow the water to drain. This will drain the water from both the hex box and the LC40 laser tube. It is important to drain as much water as possible in case of freezing weather. Tilting the hex box back and forth will help drain the water.
7. Store in a clean, dry dust free environment within a temperature range of 60-85 F (16-29C). Keep the laser covered to minimize dust build up inside the laser enclosure.

## SERVICEABLE PARTS

**⚠ WARNING** Observe all provided warnings and safety instructions when using the Dremel LC40. Failure to do so may result in fire, equipment damage, property damage or personal injury.

**⚠ WARNING** Have your laser cutter serviced by a qualified repair person using only identical replacement parts. This will ensure that the safety of the laser cutter is maintained.

**⚠ WARNING** Use only recommended accessories. Follow instructions that accompany accessories. Use of improper accessories may cause hazards.

The following parts are available for service:

Part Number	Description
2610047848	Lens assembly
2610047854	Mirror assembly
2610047890	Laser Tube assembly
1619PB2675	Drive Belt
2610048945	Spacer
2610048961	Exhaust hose
2610048951	Honey comb
1600A011SL	Water pump
1600A011SK	Air pump
2610048946	Alignment paper
2610048944	Lens Cleaner Wipes

## Firmware & Open Source Software

### Firmware Updates

Dremel recommends that firmware is updated whenever Dremel provides an update.

Dremel will provide firmware updates to improve performance and add additional features for the Laser Cutter throughout the life of the product. The Laser Cutter will be able to obtain new firmware by connecting the network connection (Ethernet or Wireless) to the Internet to allow the firmware to check for new firmware updates. The Laser Cutter will automatically download (in a background process) when a firmware update is available. The Laser Cutter will provide a prompt on the LCD display to allow it to proceed with the update.

### Open Source Software used in this Dremel product

This product contains software components that are licensed by the holder of the rights under any version of the GNU General Public License (GPL), GNU Lesser General Public License (LGPL) or any other open source software license which requires that source code be made available. A complete machine-readable copy of the corresponding source code is available by sending a written request to:

Dremel  
Attn: Open Source Software Officer  
P.O. Box 081126  
Racine, WI USA 53408-1126

The request should include: (i) the name of the Dremel product, (ii) the serial number (if applicable), (iii) the software version (if applicable), (iv) your name, (v) your company name (if applicable) and (vi) your return mailing and email address (if available).

We may charge you a nominal fee to cover the cost of the physical media and distribution.

Send the request (i) within three (3) years of the date product was received that included the software which is subject of your request or (ii) in the case of code licensed under the GPL version 3 for as long as Dremel offers spare parts or customer support for that product.

### ***Warranty regarding further use of the Open Source Software:***

DREMEL provides no warranty for the Open Source Software programs contained in this device, if such programs are used in any manner other than the program execution intended by DREMEL. The licenses listed below define the warranty, if any, from the authors or licensors of the Open Source Software. DREMEL specifically disclaims any warranties for defects caused by altering any Open Source Software program or the product's configuration.

You have no warranty claims against DREMEL in the event that the Open Source Software infringes the intellectual property rights of a third party. Technical support, if any, will only be provided for unmodified software.

## Dremel® Limited Warranty

Your Dremel LC40 is warranted against defective materials or workmanship for a period of one year from the date of Purchase with the exception of the following consumables: All lenses, mirrors and Laser Tube. The consumables (all mirrors, lenses and Laser Tube) are warranted against defective materials or workmanship for a period of 60 days from the date of Purchase. In the event of the product fails to conform to this written warranty, please take the following action:

1. DO NOT return your product to the place of purchase.
2. Please contact customer service
3. Carefully package the product by itself, in original packaging, with no other items, and return it, freight prepaid, along with:
  - a. A copy of your dated proof of purchase (please keep a copy for yourself).
  - b. A written statement about the nature of the problem.
  - c. Your name, address and phone number to:

CONTINENTAL UNITED STATES	CANADA	
Dremel Service Center 4915 21st Street Racine, WI 53406 Phone: 1 (800) 437-3635	Giles Tool Agency 47 Granger Av. Scarborough, ON M1K 3K9 Phone:1-416-287-3000	West Coast Tool 4008 Myrtle Street Burnaby, B.C. V5C 4G2 Phone: 1-604-873-5394
<b>OUTSIDE CONTINENTAL UNITED STATES</b> See your local distributor or write to Dremel, 4915 21st Street Racine, WI 53406.		

We recommend that the package be insured against loss or in-transit damage, for which we cannot be responsible.

This warranty applies only to the original registered purchaser. DAMAGE TO THE PRODUCT RESULTING FROM TAMPERING, ACCIDENT, ABUSE, NEGLIGENCE, UNAUTHORIZED REPAIRS OR ALTERATIONS, PRODUCT USE IN VIOLATION OF THE "GENERAL SAFETY AND USE WARNINGS," UNAPPROVED ATTACHMENTS OR OTHER CAUSES UNRELATED TO PROBLEMS WITH MATERIAL OR WORKMANSHIP ARE NOT COVERED BY THIS WARRANTY.

No employee, agent, dealer or other person is authorized to give any warranties on behalf of Dremel. If Dremel inspection shows that the problem was caused by problems with material or workmanship within the limitations of the warranty, Dremel will repair or replace the product free of charge and return the product prepaid. Repairs made necessary by normal wear or abuse, or repair for products outside of the warranty period, if they can be made, will be charged at regular factory prices.

**DISCLAIMER OF IMPLIED WARRANTIES: DREMEL MAKES NO OTHER WARRANTY OF ANY KIND WHATEVER, EXPRESSED OR IMPLIED, AND ALL IMPLIED WARRANTIES OF MERCHANTABILITY AND FITNESS FOR A PARTICULAR PURPOSE ARE HEREBY DISCLAIMED BY DREMEL AND EXCLUDED FROM THIS LIMITED WARRANTY.**

This warranty gives you specific legal rights, and you may also have other rights which vary from state to state. The obligation of the warrantor is solely to repair or replace the product. The warrantor is not liable for any incidental or consequential damages due to any such alleged defect. Some states do not allow the exclusion or limitation of incidental or consequential damages, so the above limitations or exclusion may not apply to you.

For prices and warranty fulfillment in the continental United States, contact a Dremel service location.

Robert Bosch Tool Corporation  
1800 West Central Road  
Mount Prospect, Illinois 60056