

Data sheet | Item number: 770-636

h-distribution connector; 3-pole; Cod. A; 1 input; 2 outputs; outputs on one side; 3 locking levers; for flying leads; black

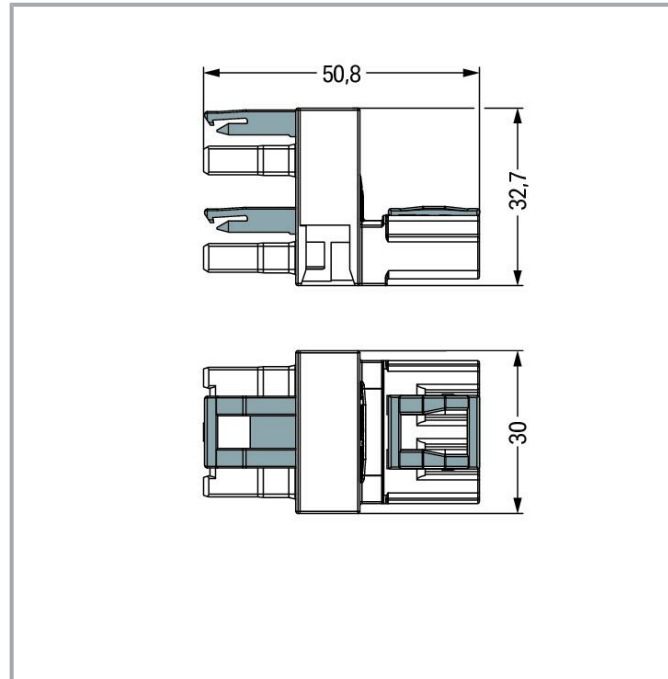

www.wago.com/770-636



Item description

Distribution connector *WINSTA*® MIDI with protection type IP20

The *WINSTA*® MIDI distribution connector with locking latch supports fast, reliable installation. Whether on PCBs, in control cabinets or for connecting lights – pluggable installation connectors from WAGO allow you to make connections according to many different requirements in next to no time. For greater protection in electrical installations, the pluggable installation connector is equipped with mechanical protection against mismatching. The pluggable installation connector is protected against ingress by solid objects in accordance with protection type IP20 (When mated: IP2xC (These compact connectors are not designed for use in open, easily accessible areas!)). Thanks to the color coding and mechanical A coding of *WINSTA*® MIDI pluggable installation connectors, you can clearly distinguish different circuits. This pluggable installation connector is used for electrical currents up to 25 A. Thus the product is especially suitable for high power loads. The *WINSTA*® MIDI Pluggable Connection System with Push-in CAGE CLAMP® spring pressure connection technology facilitates precise electrification. Thanks to the built-in test slot, connections can be checked even when they are plugged in. This saves time, labor, and money.

Subject to changes. Please also observe the further product documentation!

WAGO GmbH & Co. KG
Hansastr. 27
32423 Minden
Phone: +49571 887-0 | Fax: +49571 887-169
Email: info.de@wago.com | Web: www.wago.com

Do you have any questions about our products?
We are always happy to take your call at +49 (571) 887-44222.



Push-in CAGE CLAMP® spring pressure connection technology – pluggable installation instead of laborious screw connections!

The WINSTA® Pluggable Connection System allows pluggable electrical installation. This saves time, lowers costs, and reduces the need for servicing. Choose durability and quality – the WINSTA® MIDI pluggable installation connector with locking lever from WAGO makes the electrical installation of electrical components visibly easier.

- effective protection against mismatching
- for automation controllers
- with A coding for use in a large number of general mains applications
- custom-engineered solutions
- fast, secure installation

Data

Electrical data

Ratings per IEC/EN

Ratings per	IEC/EN 60664-1
Nominal voltage (III/3)	250 V
Rated impulse voltage (III/3)	4 kV
Rated current	25 A
Legend (ratings)	(III / 3) ≙ Overvoltage category III / Pollution degree 3

Ratings per UL 1977

Note for the US market	Some versions may also be used for current interruption in accordance with the UL certificate in select applications with currents below 16 A and voltages up to 600 V. For further information, please contact your local sales office.
Rated voltage (UL 1977)	600 V
Rated current UL 1977	23 A

General

Note on contact resistance	approx. 1 mΩ of contact resistance approx. 0.25 mΩ contact transition plug/socket
----------------------------	--------------------------------------------------------------------------------------

Subject to changes. Please also observe the further product documentation!



Connection data

Total number of potentials	3
PE function	Preceding PE contact

Connection 1

Pole number	3
-------------	---

Physical data

Pin spacing	10 mm / 0.394 inches
Width	30 mm / 1.181 inches
Height	32.7 mm / 1.287 inches
Depth	51 mm / 2.008 inches

Mechanical Data

Application	General mains applications
Coding	A
Marking	L \perp N
Potential marking	L \perp N
Mating force of a plug-in connection	approx. 20 ... 70 N (depending on pole number)
Retention force of a plug-in connection	When locked: > 80 N
Unmating force of a plug-in connection	Unlocked: approx. 20 ... 70 N (depending on pole number)
Number of mating cycles	200, without resistive load
Type of distribution box	h-distribution connector, outputs on one side
Protection type	IP20; When mated: IP2xC (These compact connectors are not designed for use in open, easily accessible areas!)
Suitable	for flying leads

Plug-in connection

Contact type (pluggable connector)	Socket/plug
Mismating protection	Yes
Note on mismating protection	All WINSTA [®] components are 100% protected against mismating when: a.) plugging different numbers of poles b.) plugging while rotated 180 c.) plugging while laterally staggered d.) plugging one pole
Locking lever	yes

Subject to changes. Please also observe the further product documentation!



Locking of plug-in connection	locking lever
Note on locking system	All connectors for mounted installations (snap-in versions for lighting fixtures or devices, all types of PCB and distribution connectors) are factory-equipped with locking levers to ensure plugs and sockets are securely locked. Additional locking levers are only required for flying leads (plug/socket).

Material Data

Note (material data)	Information on material specifications can be found here
Color	black
Insulation material	Polyamide (PA66)
Flammability class per UL94	V0
Contact material	Copper or copper alloy; surface-treated
Contact plating	Tin
Fire load	0.552 MJ
Weight	22.8 g

Environmental requirements

Processing temperature	-5 ... +40 °C
Continuous operating temperature	-35 ... +85 °C
Note on continuous operating temperature	Insulating parts for temperatures \leq 105 °C

Commercial data

eCl@ss 10.0	27-44-06-03
eCl@ss 9.0	27-44-06-03
ETIM 8.0	EC002567
ETIM 7.0	EC002567
PU (SPU)	50 pcs
Packaging type	box
Country of origin	DE
GTIN	4045454251475
Customs tariff number	85366990990



Environmental Product Compliance

RoHS Compliance Status	Compliant, No Exemption
------------------------	-------------------------

Subject to changes. Please also observe the further product documentation!

Approvals / Certificates



General approvals

Logo	Approval	Additional Approval Text	Certificate name
	CCA DEKRA Certification B.V.	EN 61535	71-123228
	CCA DEKRA Certification B.V.	IEC 61535	NL -84761
	cURus Underwriters Laboratories Inc.	UL 1977	E45171

Declarations of conformity and manufacturer's declarations

Logo	Approval	Additional Approval Text	Certificate name
	EU-Declaration of Conformity WAGO GmbH & Co. KG	-	-

Approvals for marine applications









Logo	Approval	Additional Approval Text	Certificate name
	ABS American Bureau of Shipping	-	19-HG1868589-PDA
	DNV GL Det Norske Veritas, Germanischer Lloyd	-	TAE00001Z6
	LR Lloyds Register	IEC 61984	LR22429487TA

Subject to changes. Please also observe the further product documentation!

WAGO GmbH & Co. KG
 Hansastr. 27
 32423 Minden
 Phone: +49571 887-0 | Fax: +49571 887-169
 Email: info.de@wago.com | Web: www.wago.com

Do you have any questions about our products?
 We are always happy to take your call at +49 (571) 887-44222.

Counterpart

	Item no.770-103 Socket; with strain relief housing; 3-pole; Cod. A; 4,00 mm ² ; black	www.wago.com/770-103
	Item no.770-113 Plug; with strain relief housing; 3-pole; Cod. A; 4,00 mm ² ; black	www.wago.com/770-113
	Item no.770-203 Socket; 3-pole; Cod. A; 4,00 mm ² ; black	www.wago.com/770-203
	Item no.770-213 Plug; 3-pole; Cod. A; 4,00 mm ² ; black	www.wago.com/770-213
	Item no.770-203/035-000 Socket; with strain relief housing; 3-pole; Cod. A; 4,00 mm ² ; black	www.wago.com/770-203/035-000
	Item no.771-9993/106-101 pre-assembled connecting cable; Eca; Socket/open-ended; 3-pole; Cod. A; H05VV-F 3G 1.5 mm ² ; 1 m; 1,50 mm ² ; black	www.wago.com/771-9993/106-101
	Item no.771-9993/006-101 pre-assembled interconnecting cable; Eca; Socket/plug; 3-pole; Cod. A; H05VV-F 3G 1.5 mm ² ; 1 m; 1,50 mm ² ; black	www.wago.com/771-9993/006-101
	Item no.770-213/035-000 Plug; with strain relief housing; 3-pole; Cod. A; 4,00 mm ² ; black	www.wago.com/770-213/035-000
	Item no.771-9993/206-101 pre-assembled connecting cable; Eca; Plug/open-ended; 3-pole; Cod. A; H05VV-F 3G 1.5 mm ² ; 1 m; 1,50 mm ² ; black	www.wago.com/771-9993/206-101

Optional accessories

Cover		
Cover		
	Item no.: 770-360 Lockout cap; for plugs; 5-pole; separable; yellow	www.wago.com/770-360
	Item no.: 770-201 Lockout cap; 12-pole, separable; for sockets; Plastic; black	www.wago.com/770-201
	Item no.: 770-221 Lockout cap; 12-pole, separable; for sockets; Plastic; white	www.wago.com/770-221

Mounting

Mounting accessories		
----------------------	--	--

Subject to changes. Please also observe the further product documentation!



Item no.: 770-623

Mounting plate; 3-pole; for distribution connectors; Plastic; black

www.wago.com/770-623



Item no.: 770-673

Mounting plate; 3-pole; for distribution connectors; Plastic; white

www.wago.com/770-673

Downloads

Documentation

Bid Text

770-636 X81 - Datei	2019 Feb 19	xml 2.9 kB	Download
770-636 doc - Datei	2015 Mar 12	doc 23.6 kB	Download
ausschreiben.de 770-636		URL	Download

CAD/CAE-Data

CAD data

2D/3D Models 770-636		URL	Download
----------------------	--	-----	----------

CAE data

EPLAN Data Portal 770-636		URL	Download
WSCAD Universe 770-636		URL	Download
ZUKEN Portal 770-636		URL	Download

Environmental Product Compliance

Compliance Search

Environmental Product Compliance 770-636 h-distribution connector; 3-pole; Cod. A; 1 input; 2 outputs; outputs on one side; 3 locking levers; for flying leads; black		URL	Download
--------------------------------------------------------------------------------------------------------------------------------------------------------------------------	--	-----	----------

Subject to changes. Please also observe the further product documentation!

Installation Notes

Installation

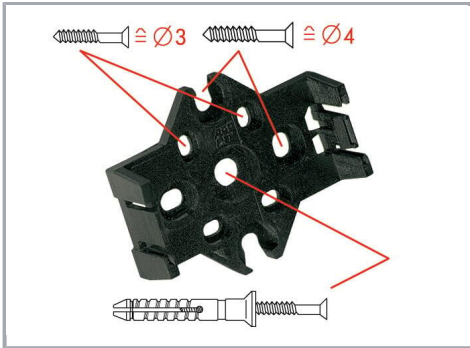

Mounting plates can be secured using commercially available screws or nail-drive anchors.



The distribution connectors snap together when attached to the mounting plate.



To release the distribution connector, unlock the latch using a screwdriver.

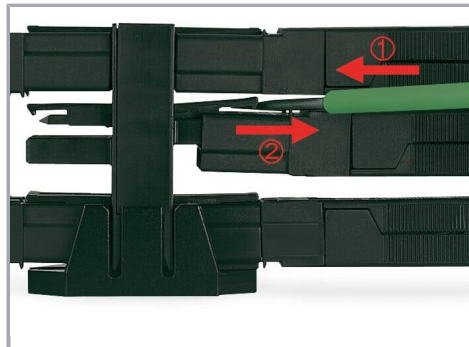

All distribution connector connections are locked and protected against accidental disconnection directly after mating. Locking of any connection is released using a screwdriver, even if all connections are used.

Product family

WINSTA® MIDI

[Show all products from the family](#)

Subject to changes. Please also observe the further product documentation!