



APPLICATION SPECIFICATION

TITLE

GPS L1/L5 25MM STACKED PATCH ANTENNA

TABLE OF CONTENTS

1.0 SCOPE

2.0 PRODUCT DESCRIPTION

3.0 APPLICABLE DOCUMENTS

4.0 ANTENNA PERFORMANCE

5.0 RF PERFORMANCE AS A FUNCTION OF IMPLEMENTATION

REVISION: A1	ECR/ECN INFORMATION: EC No: 616280 DATE: 2019/04/26	TITLE: GPS L1/L5 25mm Stacked Patch Antenna Application Specification	SHEET No. 1 of 34
DOCUMENT NUMBER: AS-2122030001	CREATED / REVISED BY: Liu Hai 2019/04/16	CHECKED BY: Cheng Kang 2019/04/16	APPROVED BY: Andy Zhang 2019/04/16

GPS L1+L5 PATCH CERAMIC ANTENNA

1.0 SCOPE

This specification describes the antenna application and surrounding. The information in this document is for reference and benchmark purposes only. The user is responsible for validating antenna RF performance based on the user's actual implementation.

All measurements are done of the antenna mounted on the recommended PCB with VNA Agilent 5071C and OTA chamber.

Antenna illustrations in this document are generic representations. They are not intended to be an image of any antenna listed in the scope.

2.0 PRODUCT DESCRIPTION

2.1 PRODUCT NAME AND SERIES NUMBER (S)

Product name: GPS L1/L5 25mm stacked patch antenna

Series Number: 212203

2.2 DESCRIPTION

212203 is a 25x25mm and 15x15mm two ceramic patch stacked for GPS L1/L5. It's designed for high precision tracking applications: UAV and drones, Vehicle tracking, RTK (Real-Time Kinematic)...

2.3 PRODUCT STRUCTURE INFORMATION

Please refer to PS-2122030001 for full information.



Molex 2122030001 GPS L1/L5 Stacked Patch Antenna 3D View

REVISION: A1	ECR/ECN INFORMATION: EC No: 616280 DATE: 2019/04/26	TITLE: GPS L1/L5 25mm Stacked Patch Antenna Application Specification	SHEET No. 2 of 34
DOCUMENT NUMBER: AS-2122030001	CREATED / REVISED BY: Liu Hai 2019/04/16	CHECKED BY: Cheng Kang 2019/04/16	APPROVED BY: Andy Zhang 2019/04/16

3.0 APPLICABLE DOCUMENTS

DOCUMENT	NUMBER	DESCRIPTION
Sale Drawing (SD)	SD-2122030001	Mechanical Dimension of the product
Product Specification (PS)	PS-2122030001	Product Specification
Packing Drawing (PK)	PK-2122030001	Product packaging specifications

4.0 ANTENNA PERFORMANCE

4.1 TEST ASSEMBLY INSTRUCTIONS

THE FOLLOWING STEPS ARE FOR ASSEMBLY INSTRUCTION:

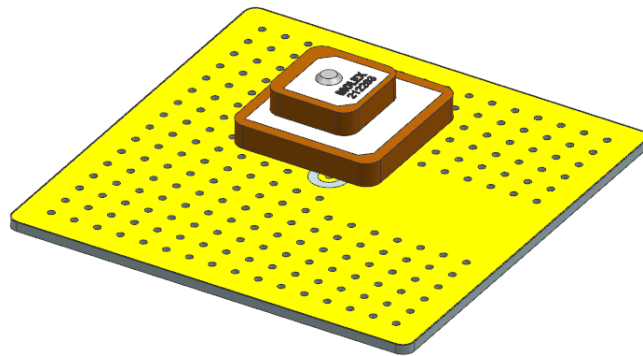

Release the liner and stick the antenna on the PCB

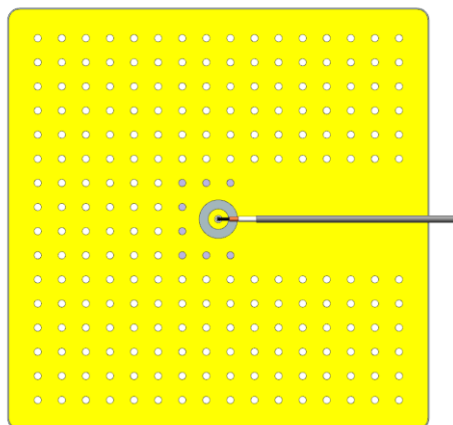

Solder antenna pin on PCB

REVISION: A1	ECR/ECN INFORMATION: EC No: 616280 DATE: 2019/04/26	TITLE: GPS L1/L5 25mm Stacked Patch Antenna Application Specification	SHEET No. 3 of 34
DOCUMENT NUMBER: AS-2122030001	CREATED / REVISED BY: Liu Hai 2019/04/16	CHECKED BY: Cheng Kang 2019/04/16	APPROVED BY: Andy Zhang 2019/04/16

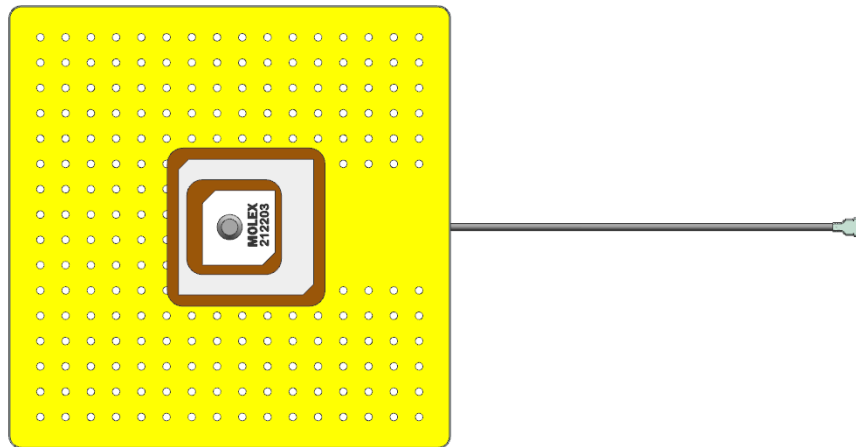

The PCB size is 70mm*70mm*1.5mm

The Antenna is fixed and soldered at the center of reference PCB with the size of 70mm*70mm and the test coaxial cable length is 100mm.

REVISION: A1	ECR/ECN INFORMATION: EC No: 616280 DATE: 2019/04/26	TITLE: GPS L1/L5 25mm Stacked Patch Antenna Application Specification		SHEET No. 4 of 34
DOCUMENT NUMBER: AS-2122030001		CREATED / REVISED BY: Liu Hai 2019/04/16	CHECKED BY: Cheng Kang 2019/04/16	APPROVED BY: Andy Zhang 2019/04/16

4.2 RF TEST CONDITIONS

All measurements are done of the antenna mounted on a 70*70mm PCB with VNA Agilent E5071C and Over-The-Air (OTA) chamber. All measurements in this document are done with the part no.2122030001 with reference PCB.

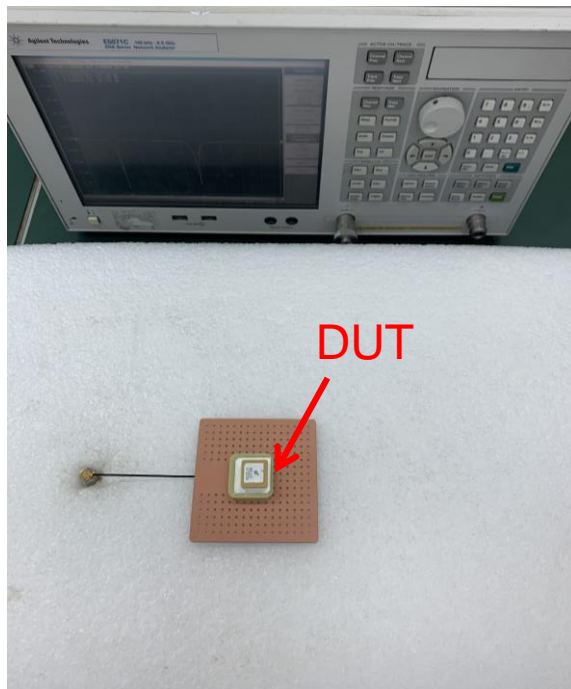

FIGURE4.2.1 ANTENNA LOADED WITH REFERENCE PCB WITH VNA



FIGURE4.2.2 ANTENNA LOADED WITH REFERENCE PCB WITH OTA CHAMBER

REVISION: A1	ECR/ECN INFORMATION: EC No: 616280 DATE: 2019/04/26	TITLE: GPS L1/L5 25mm Stacked Patch Antenna Application Specification	SHEET No. 5 of 34
DOCUMENT NUMBER: AS-2122030001	CREATED / REVISED BY: Liu Hai 2019/04/16	CHECKED BY: Cheng Kang 2019/04/16	APPROVED BY: Andy Zhang 2019/04/16



APPLICATION SPECIFICATION

4.3 ANTENNA PERFORMANCE

DESCRIPTION	EQUIPMENT	REQUIREMENT	
Frequency Range	VNA E5071C	GSP L5:1176.45MHz	GPS L1:1575.42 MHz
Return Loss	VNA E5071C	<- 20dB	<-15dB
Peak Gain (Max)	OTA Chamber	3.1dBi	4.9dBi
Average Total Efficiency	OTA Chamber	>65%	>75%
Axial Ratio	OTA Chamber	<3dB	<3dB
Polarization	OTA Chamber	RHCP	
Input Impedance	VNA E5071C	50 ohms	

Note that the above antenna performance is measured with just the antenna mounted on a 70*70mm PCB to similar a free-space condition. When implement into the system, the frequency resonant might be off-tune due to the loading of surrounding components especially metal plane. This off-tune can be compensated through matching. Although module manufacturers specify a peak gain limit, it is based on free-space conditions. The peak gain will be degraded by 1 to 2dBi in the actual implementation as the radiation pattern will change due to the surround components. As such, during selection of antenna, you can select one with high peak gain to compensate for the loss. Molex can offer assistant to choose the best location and best tuning in-order to meet this peak gain requirement.

REVISION: A1	ECR/ECN INFORMATION: EC No: 616280 DATE: 2019/04/26	TITLE: GPS L1/L5 25mm Stacked Patch Antenna Application Specification	SHEET No. 6 of 34
DOCUMENT NUMBER: AS-2122030001	CREATED / REVISED BY: Liu Hai 2019/04/16	CHECKED BY: Cheng Kang 2019/04/16	APPROVED BY: Andy Zhang 2019/04/16

4.4 RETURN LOSS PLOT

All measurements in this document are done on the reference PCB.

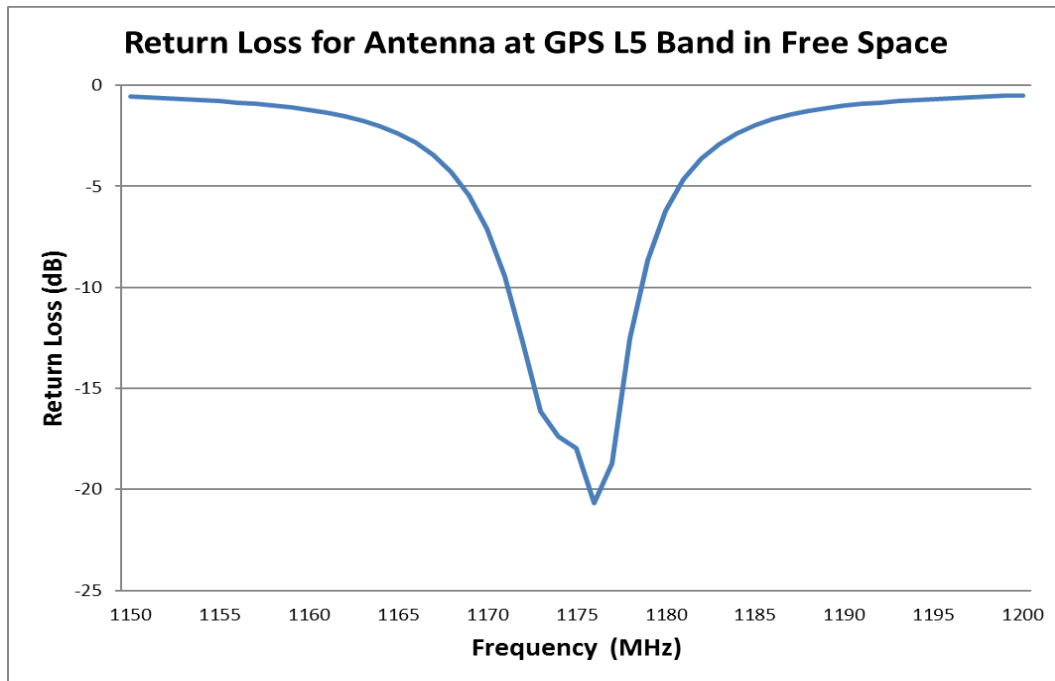

FIGURE 4.4.1 RETURN LOSS OF ANTENNA AT GPS L5 BAND IN FREE SPACE

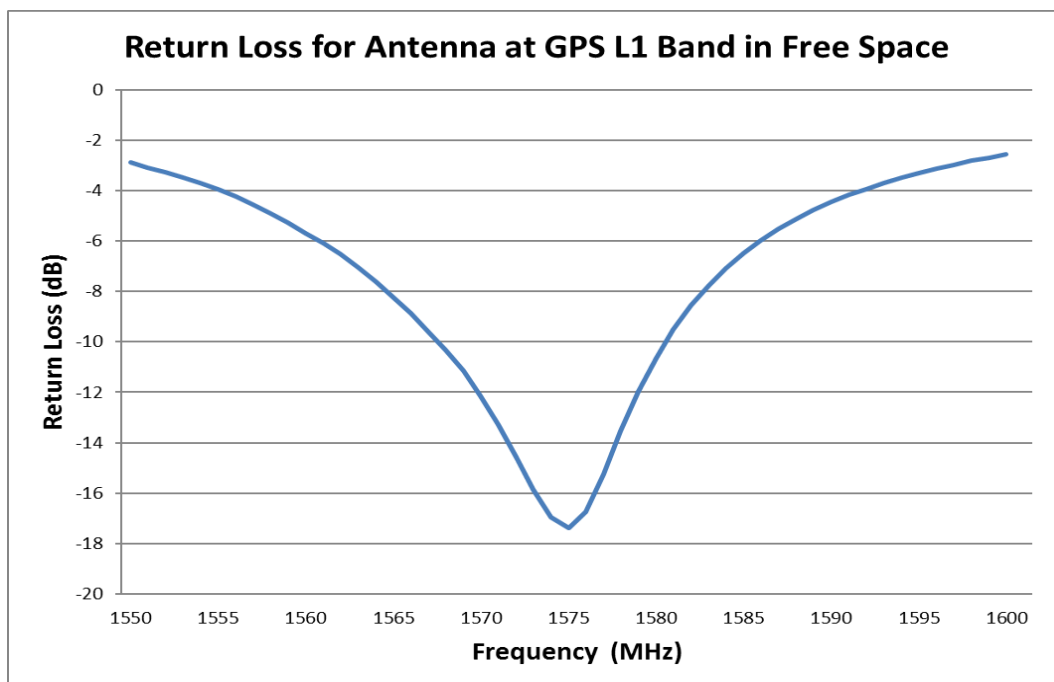

FIGURE 4.4.2 RETURN LOSS OF ANTENNA AT GPS L1 BAND IN FREE SPACE

REVISION: A1	ECR/ECN INFORMATION: EC No: 616280 DATE: 2019/04/26	TITLE: GPS L1/L5 25mm Stacked Patch Antenna Application Specification	SHEET No. 7 of 34
DOCUMENT NUMBER: AS-2122030001	CREATED / REVISED BY: Liu Hai 2019/04/16	CHECKED BY: Cheng Kang 2019/04/16	APPROVED BY: Andy Zhang 2019/04/16

4.5 EFFICIENCY PLOT

All measurements in this document are done on the reference PCB.

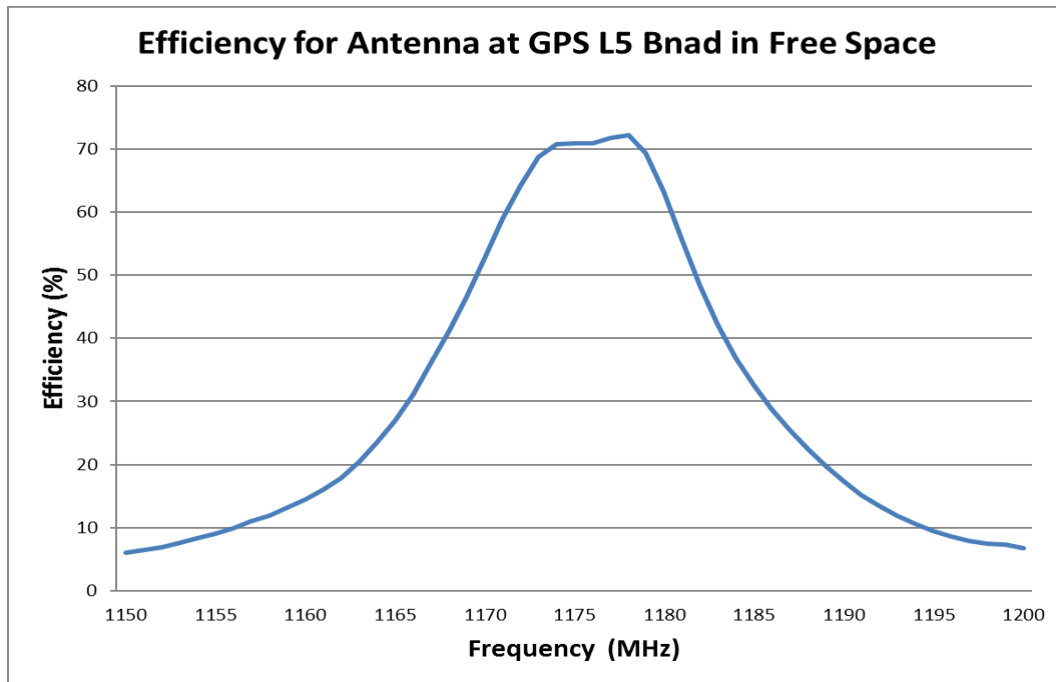

FIGURE 4.5.1 EFFICIENCY OF ANTENNA AT GPS L5 BAND IN FREE SPACE

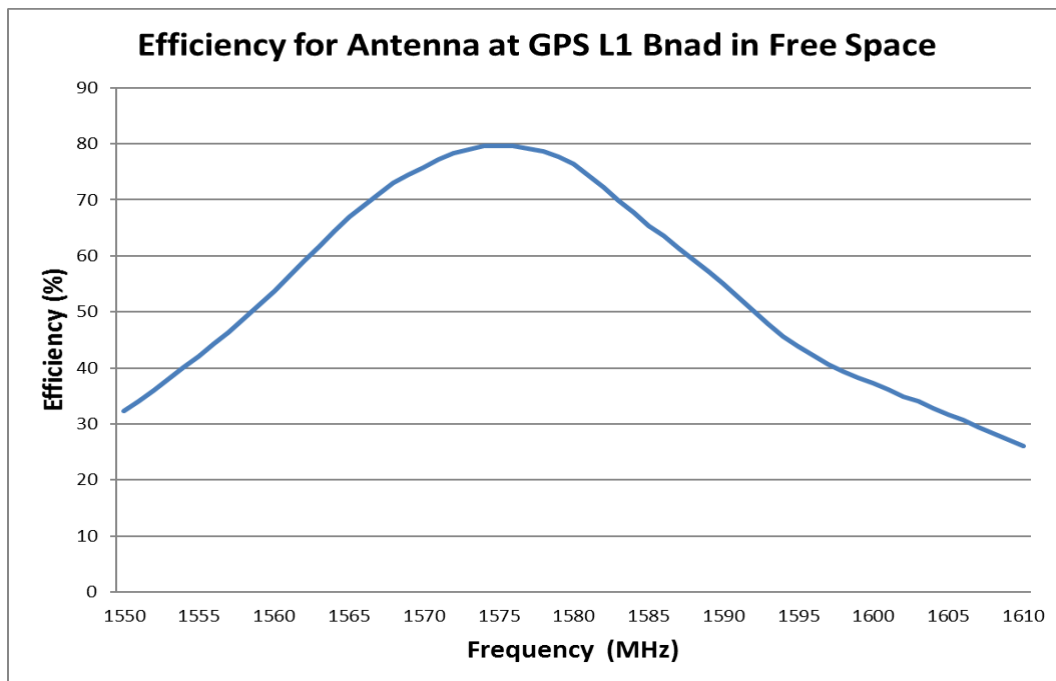

FIGURE 4.5.2 EFFICIENCY OF ANTENNA AT GPS L1 BAND IN FREE SPACE

REVISION: A1	ECR/ECN INFORMATION: EC No: 616280 DATE: 2019/04/26	TITLE: GPS L1/L5 25mm Stacked Patch Antenna Application Specification	SHEET No. 8 of 34
DOCUMENT NUMBER: AS-2122030001	CREATED / REVISED BY: Liu Hai 2019/04/16	CHECKED BY: Cheng Kang 2019/04/16	APPROVED BY: Andy Zhang 2019/04/16

4.6 PEAK GAIN PLOT

All measurements in this document are done on the reference PCB.

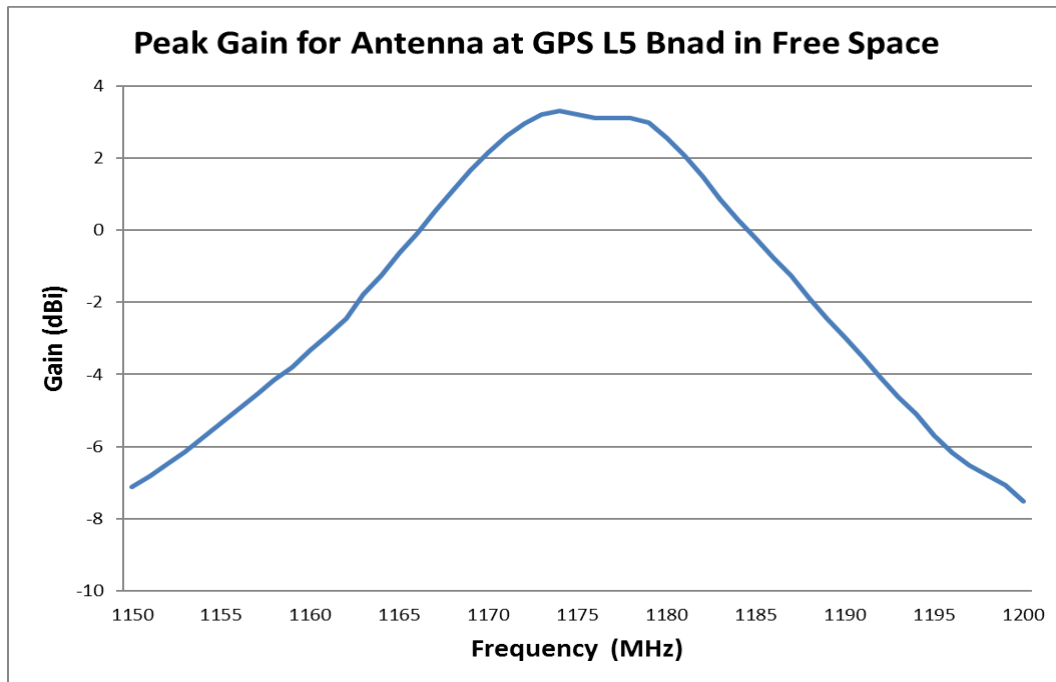

FIGURE 4.6.1 PEAK GAIN OF ANTENNA AT GPS L5 BAND IN FREE SPACE

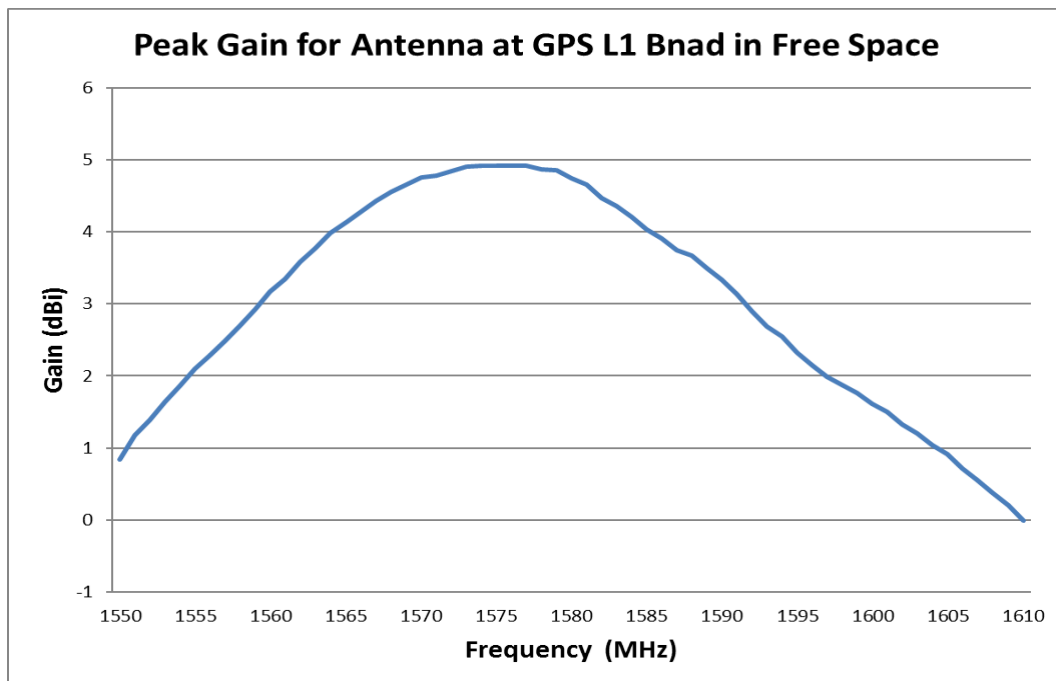

FIGURE 4.6.2 PEAK GAIN OF ANTENNA AT GPS L1 BAND IN FREE SPACE

REVISION: A1	ECR/ECN INFORMATION: EC No: 616280 DATE: 2019/04/26	TITLE: GPS L1/L5 25mm Stacked Patch Antenna Application Specification	SHEET No. 9 of 34
DOCUMENT NUMBER: AS-2122030001	CREATED / REVISED BY: Liu Hai 2019/04/16	CHECKED BY: Cheng Kang 2019/04/16	APPROVED BY: Andy Zhang 2019/04/16

4.7 AXIAL RATIO PLOT

All measurements in this document are done on the reference PCB.

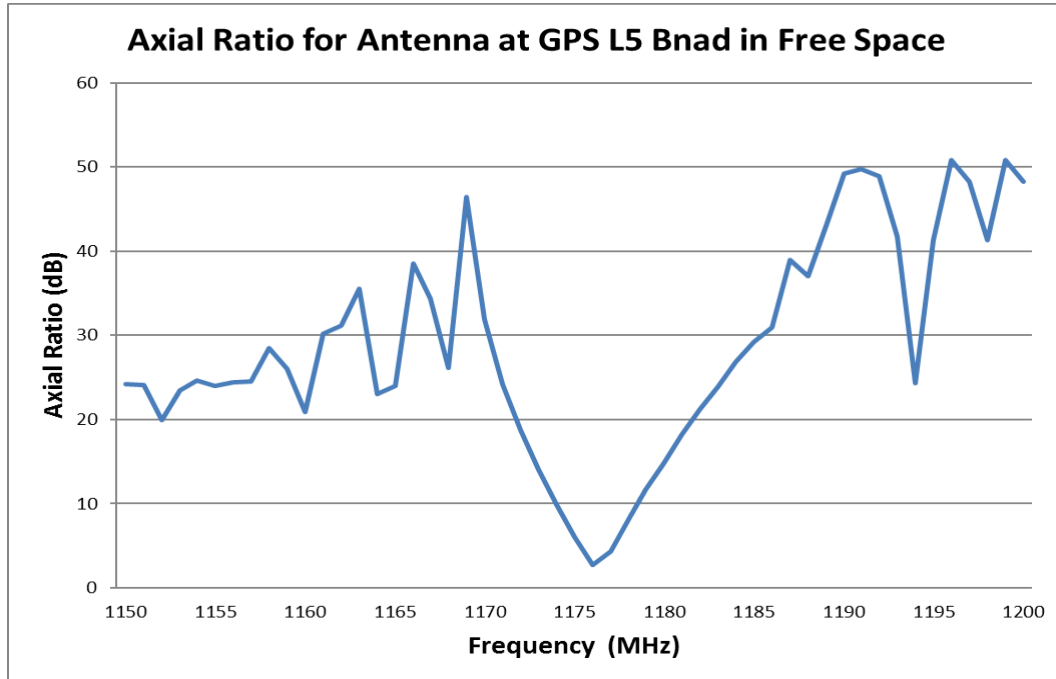

FIGURE 4.7.1 AXIAL RATIO OF ANTENNA AT GPS L5 BAND IN FREE SPACE

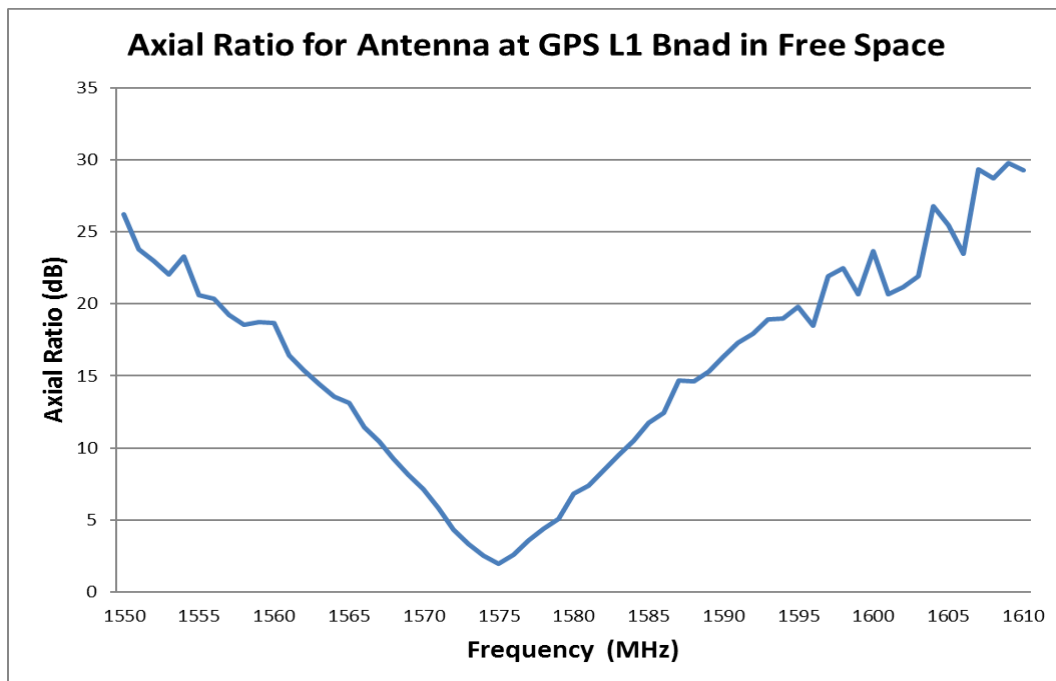

FIGURE 4.7.2 AXIAL RATIO OF ANTENNA AT GPS L1 BAND IN FREE SPACE

REVISION: A1	ECR/ECN INFORMATION: EC No: 616280 DATE: 2019/04/26	TITLE: GPS L1/L5 25mm Stacked Patch Antenna Application Specification	SHEET No. 10 of 34
DOCUMENT NUMBER: AS-2122030001	CREATED / REVISED BY: Liu Hai 2019/04/16	CHECKED BY: Cheng Kang 2019/04/16	APPROVED BY: Andy Zhang 2019/04/16

4.8 RADIATION PATTERN

All measurements in this document are done on the reference PCB.

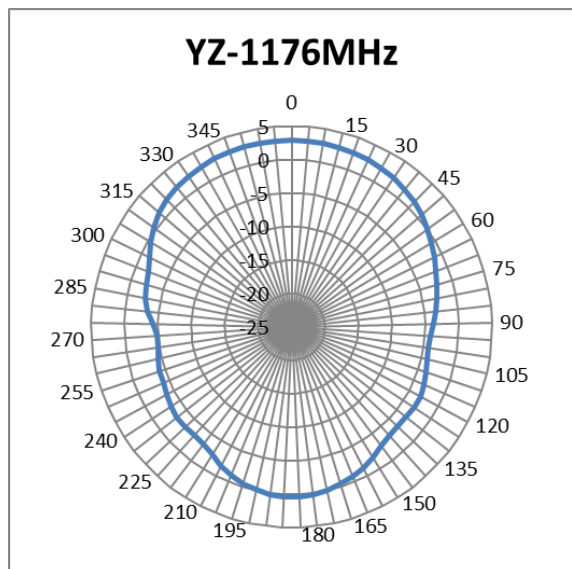
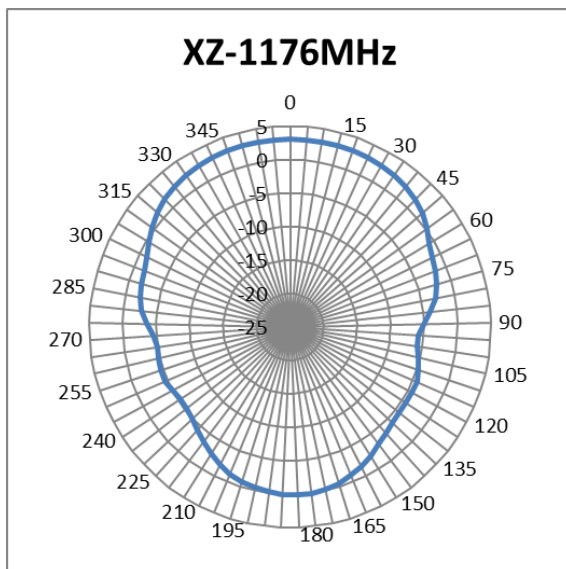
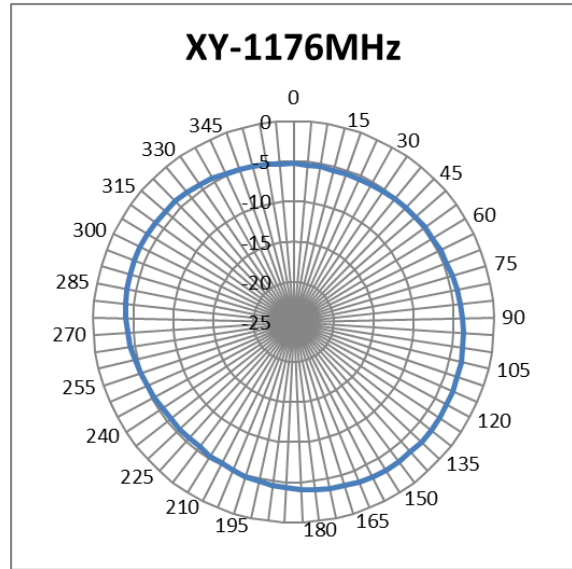
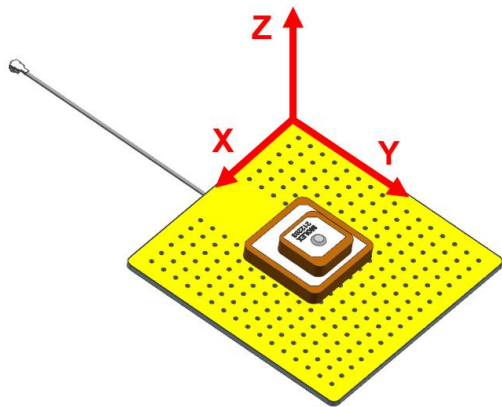

FIGURE 4.8.1 2D RADIATION PATTERN OF ANTENNA AT 1176MHZ IN FREE SPACE

REVISION: A1	ECR/ECN INFORMATION: EC No: 616280 DATE: 2019/04/26	TITLE: GPS L1/L5 25mm Stacked Patch Antenna Application Specification	SHEET No. 11 of 34
DOCUMENT NUMBER: AS-2122030001	CREATED / REVISED BY: Liu Hai 2019/04/16	CHECKED BY: Cheng Kang 2019/04/16	APPROVED BY: Andy Zhang 2019/04/16

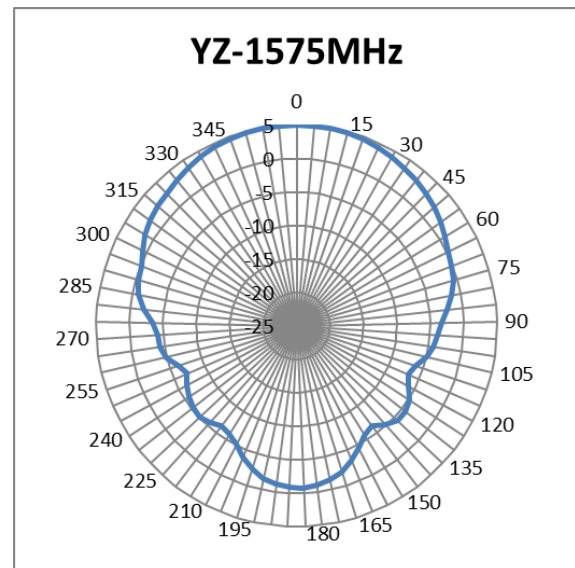
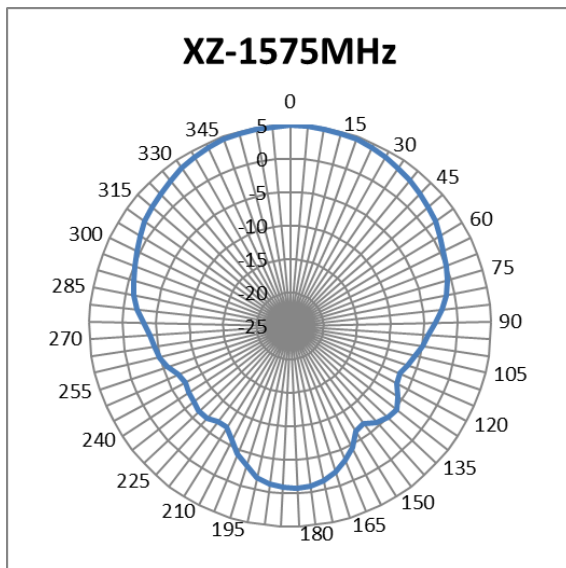
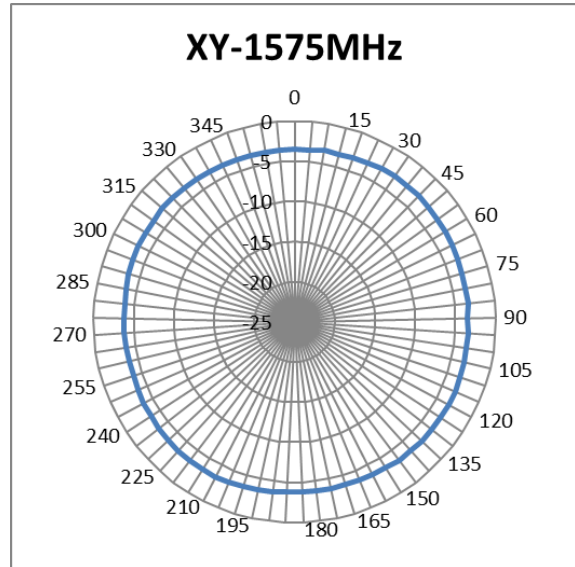
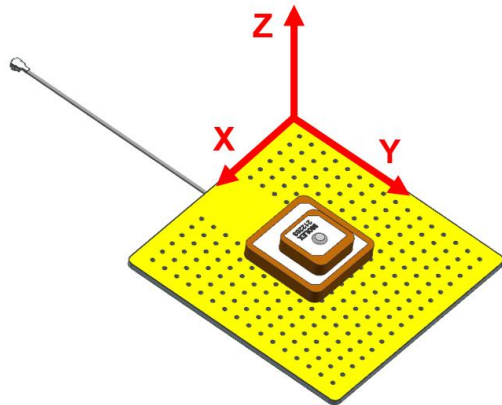

FIGURE 4.8.2 2D RADIATION PATTERN OF ANTENNA AT 1575MHZ IN FREE SPACE

REVISION: A1	ECR/ECN INFORMATION: EC No: 616280 DATE: 2019/04/26	TITLE: GPS L1/L5 25mm Stacked Patch Antenna Application Specification	SHEET No. 12 of 34
DOCUMENT NUMBER: AS-2122030001	CREATED / REVISED BY: Liu Hai 2019/04/16	CHECKED BY: Cheng Kang 2019/04/16	APPROVED BY: Andy Zhang 2019/04/16

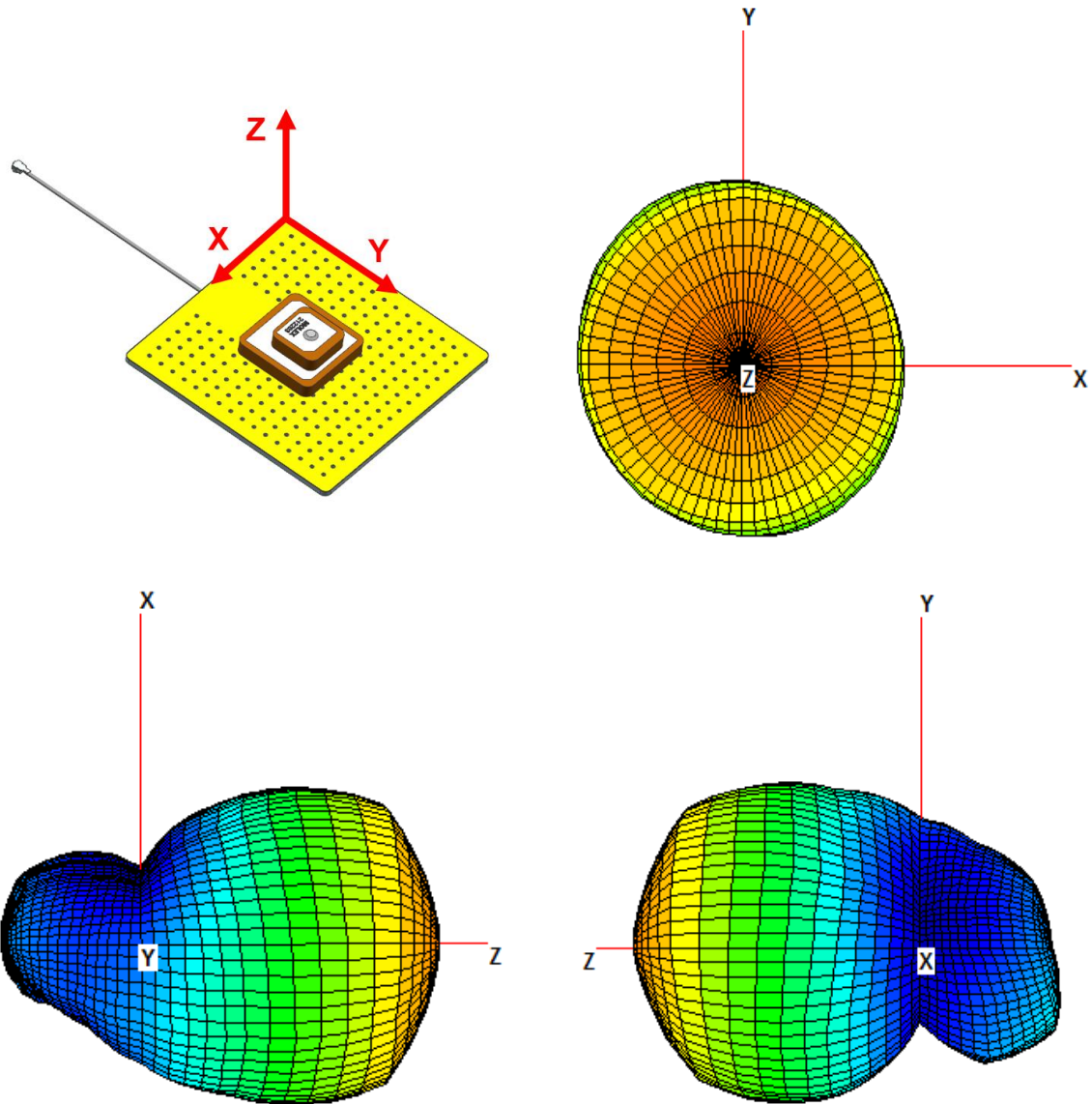

FIGURE 4.8.4 3D RADIATION PATTERN OF ANTENNA AT 1176MHZ IN FREE SPACE

REVISION: A1	ECR/ECN INFORMATION: EC No: 616280 DATE: 2019/04/26	TITLE: GPS L1/L5 25mm Stacked Patch Antenna Application Specification	SHEET No. 13 of 34
DOCUMENT NUMBER: AS-2122030001	CREATED / REVISED BY: Liu Hai 2019/04/16	CHECKED BY: Cheng Kang 2019/04/16	APPROVED BY: Andy Zhang 2019/04/16

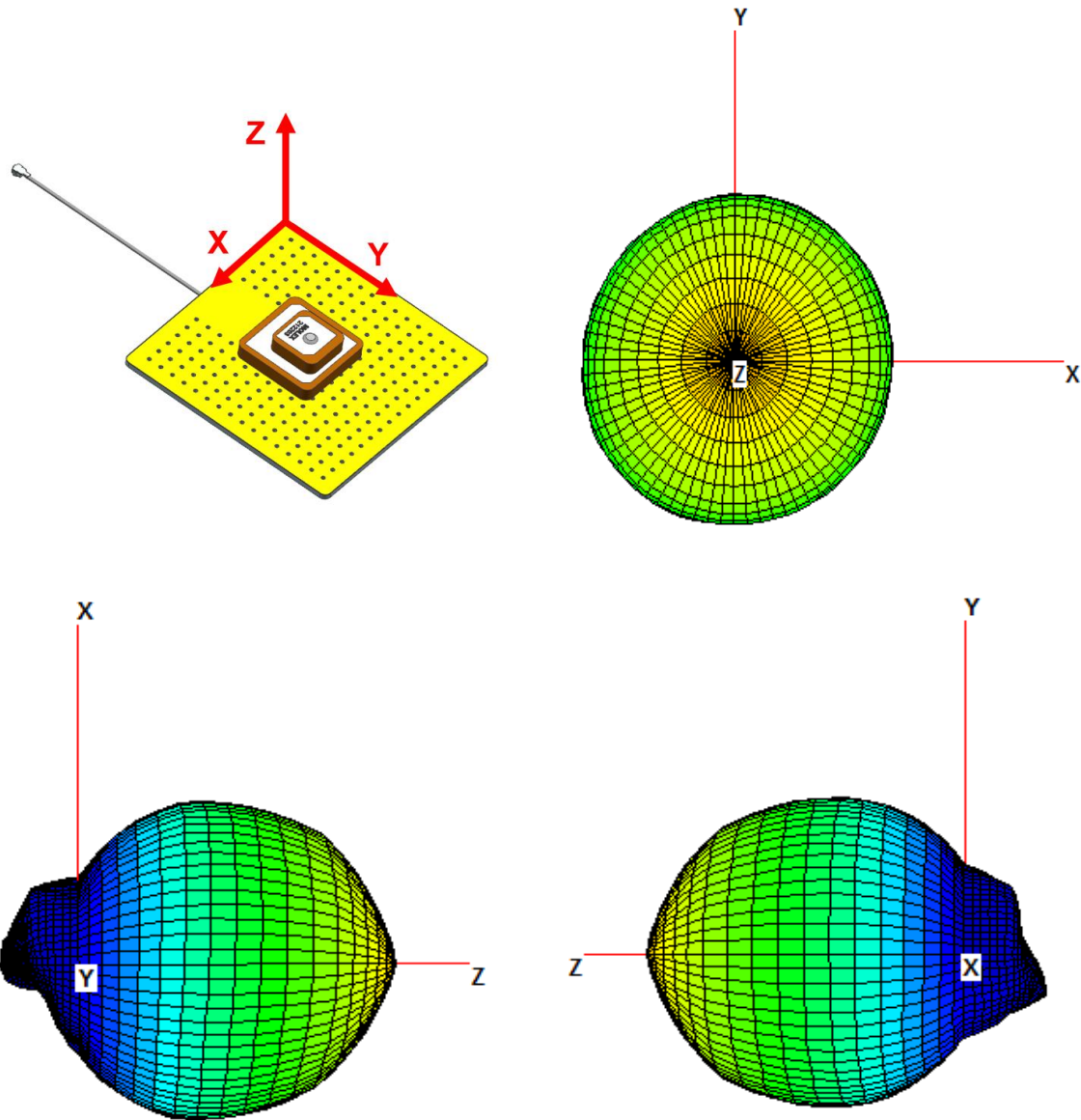

FIGURE 4.8.5 3D RADIATION PATTERN OF ANTENNA AT 1575MHZ IN FREE SPACE

REVISION: A1	ECR/ECN INFORMATION: EC No: 616280 DATE: 2019/04/26	TITLE: GPS L1/L5 25mm Stacked Patch Antenna Application Specification	SHEET No. 14 of 34
DOCUMENT NUMBER: AS-2122030001	CREATED / REVISED BY: Liu Hai 2019/04/16	CHECKED BY: Cheng Kang 2019/04/16	APPROVED BY: Andy Zhang 2019/04/16

5.0 RF PERFORMANCE AS A FUNCTION OF IMPLEMENTATION

5.1 ANTENNA RF PERFORMANCES AS A FUNCTION OF DIFFERENT LOCATIONS ON THE GROUND PLANE

Three locations have been evaluated, and these configurations are shown in figure 5.1.0. The figures 5.1.1-5.1.8 show the return loss, the efficiency, the peak gain and axial ratio.

The location which gives the best RF performance is location 1. Location 1 (center location) is the recommended location for the antenna.



FIGURE 5.1.0 THREE LOCATIONS ON REFERENCE PCB

REVISION: A1	ECR/ECN INFORMATION: EC No: 616280 DATE: 2019/04/26	TITLE: GPS L1/L5 25mm Stacked Patch Antenna Application Specification	SHEET No. 15 of 34
DOCUMENT NUMBER: AS-2122030001	CREATED / REVISED BY: Liu Hai 2019/04/16	CHECKED BY: Cheng Kang 2019/04/16	APPROVED BY: Andy Zhang 2019/04/16

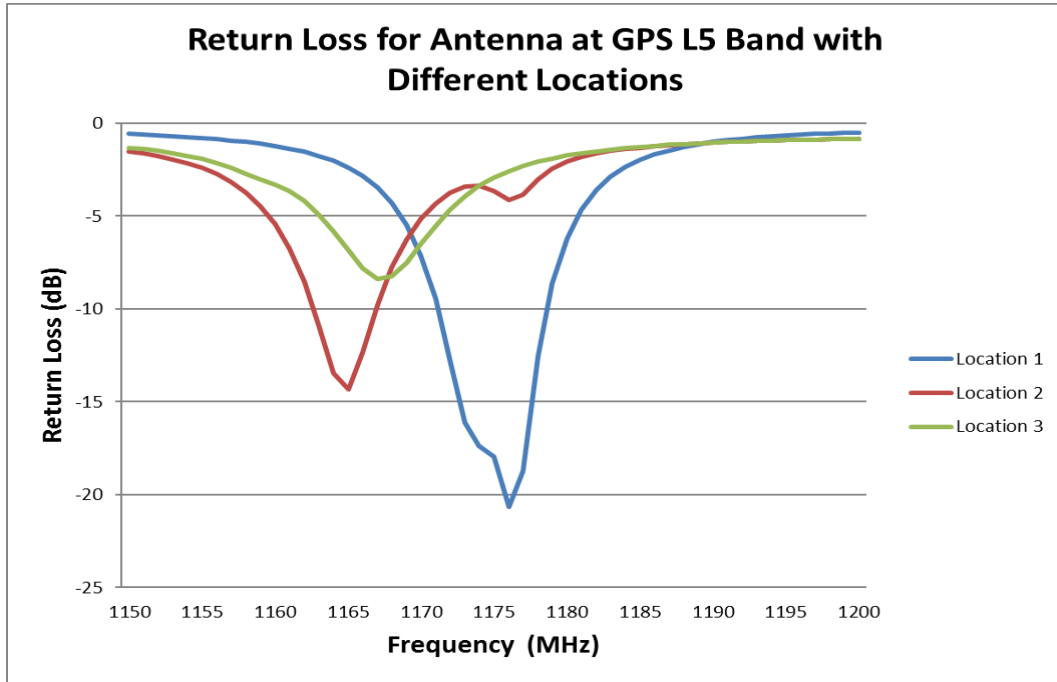

FIGURE 5.1.1 RETURN LOSS OF ANTENNA AT GPS L5 BAND AT THREE LOCATIONS

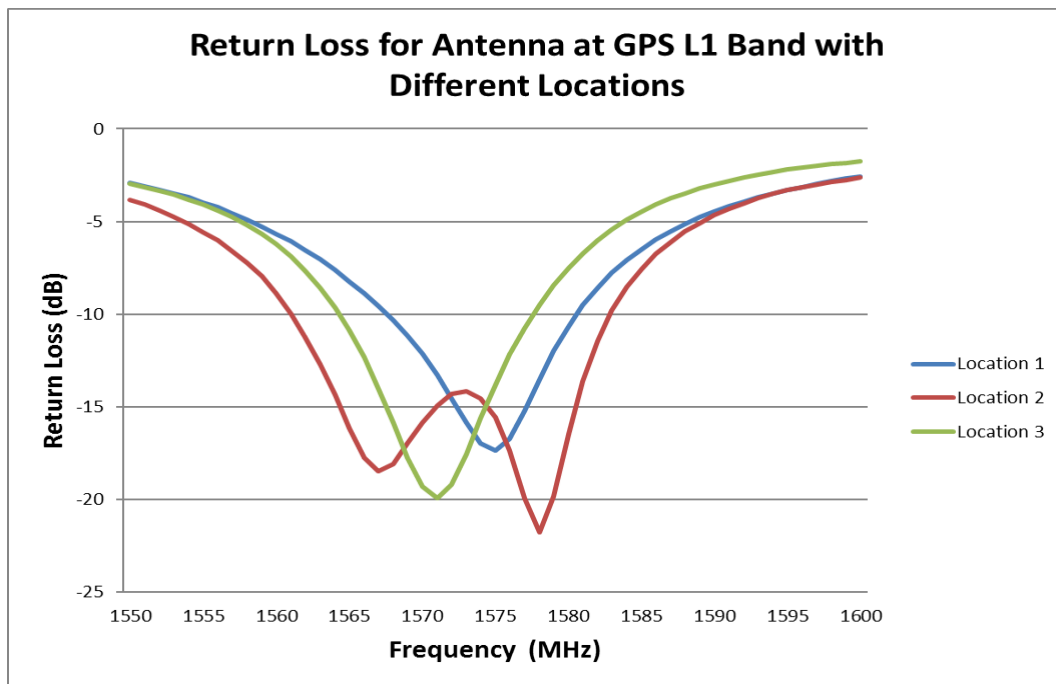

FIGURE 5.1.2 RETURN LOSS OF ANTENNA AT GPS L1 BAND AT THREE LOCATIONS

REVISION: A1	ECR/ECN INFORMATION: EC No: 616280 DATE: 2019/04/26	TITLE: GPS L1/L5 25mm Stacked Patch Antenna Application Specification	SHEET No. 16 of 34
DOCUMENT NUMBER: AS-2122030001	CREATED / REVISED BY: Liu Hai 2019/04/16	CHECKED BY: Cheng Kang 2019/04/16	APPROVED BY: Andy Zhang 2019/04/16

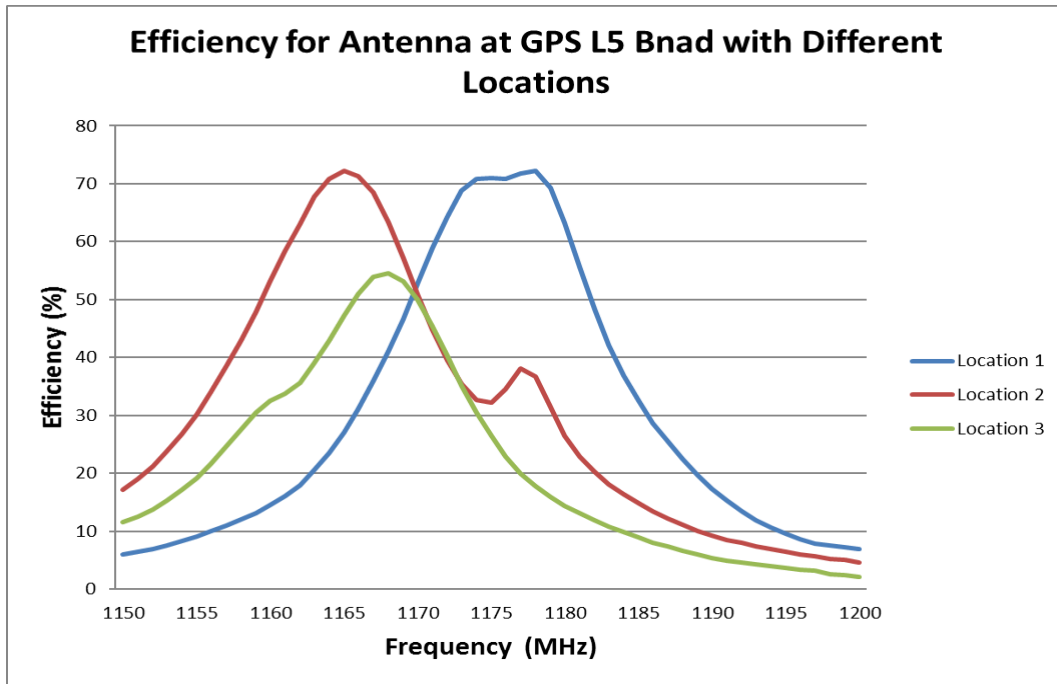

FIGURE 5.1.3 EFFICIENCY OF ANTENNA AT GPS L5 BAND AT THREE LOCATIONS

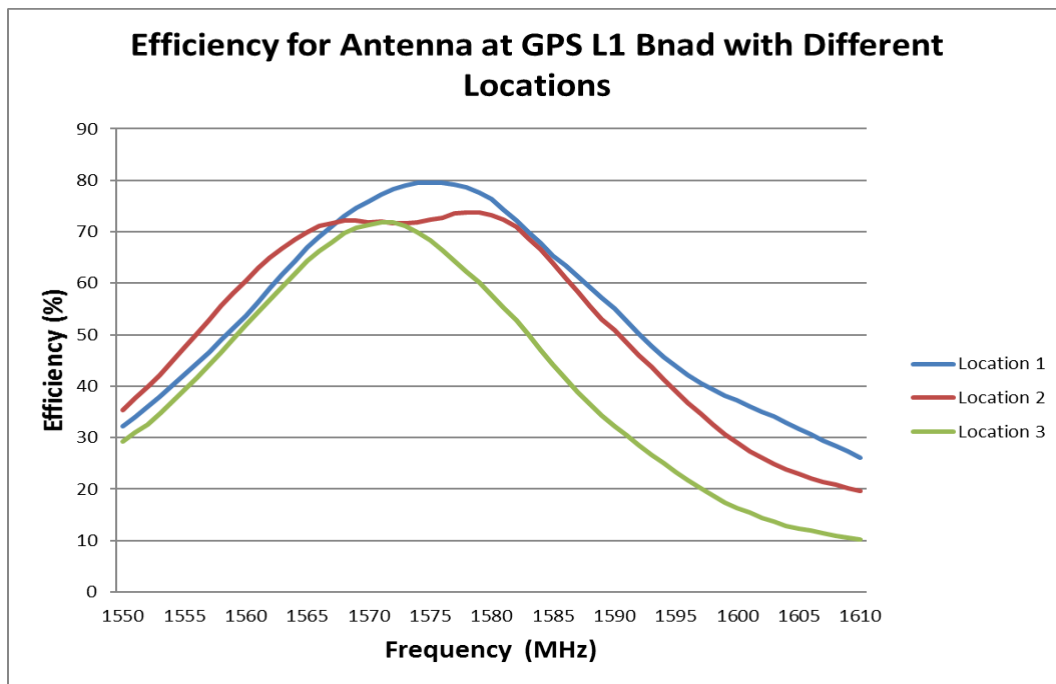

FIGURE 5.1.4 EFFICIENCY OF ANTENNA AT GPS L1 BAND AT THREE LOCATIONS

REVISION: A1	ECR/ECN INFORMATION: EC No: 616280 DATE: 2019/04/26	TITLE: GPS L1/L5 25mm Stacked Patch Antenna Application Specification	SHEET No. 17 of 34
DOCUMENT NUMBER: AS-2122030001	CREATED / REVISED BY: Liu Hai 2019/04/16	CHECKED BY: Cheng Kang 2019/04/16	APPROVED BY: Andy Zhang 2019/04/16

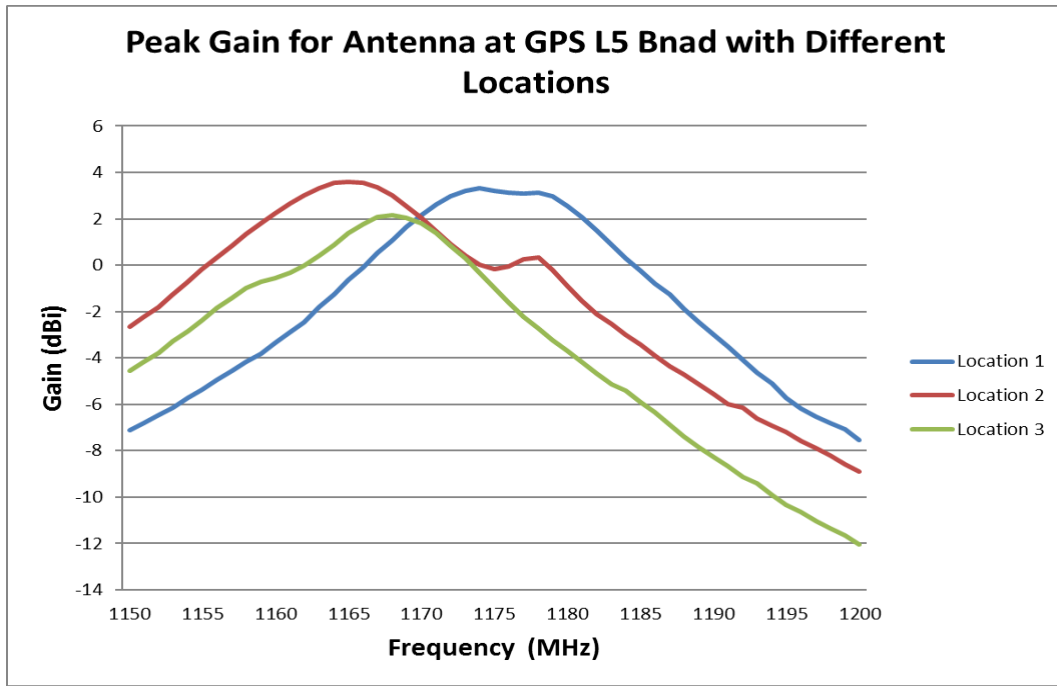

FIGURE 5.1.5 PEAK GAIN OF ANTENNA AT GPS L5 BAND AT THREE LOCATIONS

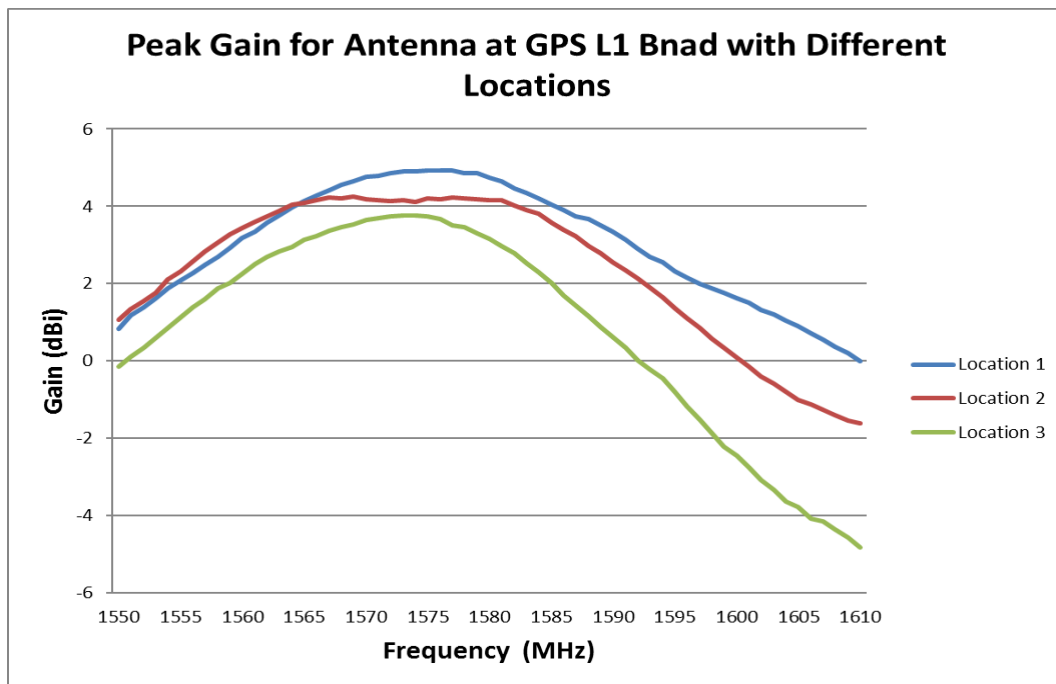

FIGURE 5.1.6 PEAK GAIN OF ANTENNA AT GPS L1 BAND AT THREE LOCATIONS

REVISION: A1	ECR/ECN INFORMATION: EC No: 616280 DATE: 2019/04/26	TITLE: GPS L1/L5 25mm Stacked Patch Antenna Application Specification	SHEET No. 18 of 34
DOCUMENT NUMBER: AS-2122030001	CREATED / REVISED BY: Liu Hai 2019/04/16	CHECKED BY: Cheng Kang 2019/04/16	APPROVED BY: Andy Zhang 2019/04/16

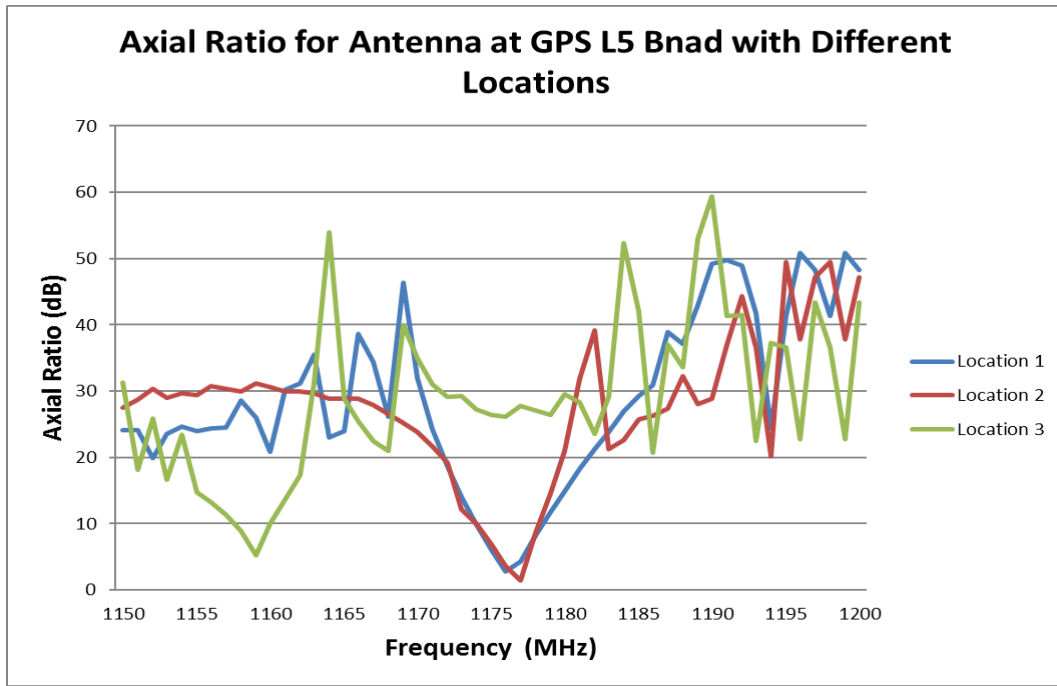

FIGURE 5.1.7 AXIAL RATIO OF ANTENNA AT GPS L5 BAND AT THREE LOCATIONS

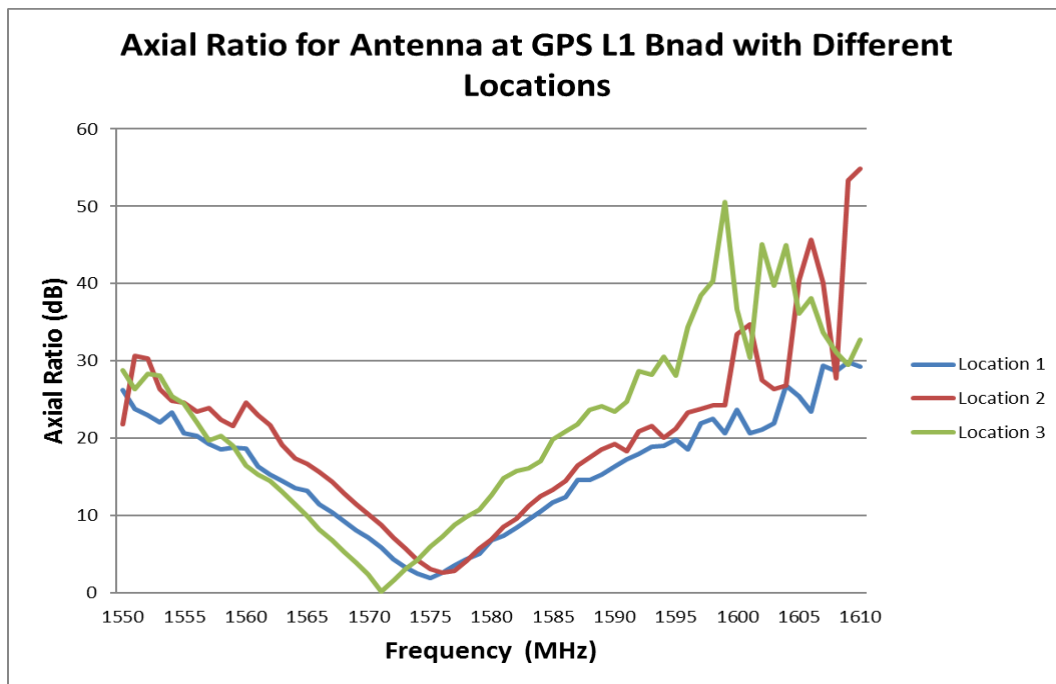
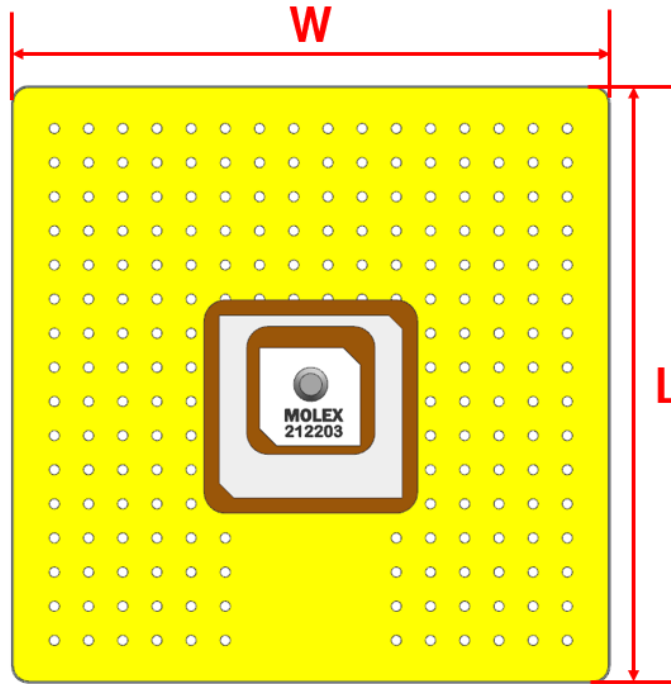

FIGURE 5.1.8 AXIAL RATIO OF ANTENNA AT GPS L1 BAND AT THREE LOCATIONS

REVISION: A1	ECR/ECN INFORMATION: EC No: 616280 DATE: 2019/04/26	TITLE: GPS L1/L5 25mm Stacked Patch Antenna Application Specification	SHEET No. 19 of 34
DOCUMENT NUMBER: AS-2122030001	CREATED / REVISED BY: Liu Hai 2019/04/16	CHECKED BY: Cheng Kang 2019/04/16	APPROVED BY: Andy Zhang 2019/04/16

5.2 ANTENNA RF PERFORMANCES AS A FUNCTION OF DIFFERENT SIZED GROUNDS

5 kinds of ground plane size have been evaluated, and these configurations are shown in figure 5.2.0. The figures 5.2.1-5.2.8 show the return loss, the efficiency, the peak gain and axial ratio. The ground plane size for this antenna is recommended to be 70mm*70mm (reference size) to meet the antenna specification.



(W*L: 25mm*25mm, 50mm*50mm, 70mm*70mm, 90mm*90mm, 120mm*120mm)

FIGURE 5.2.0 FIVE KINDS OF GROUND PLANE SIZE

REVISION: A1	ECR/ECN INFORMATION: EC No: 616280 DATE: 2019/04/26	TITLE: GPS L1/L5 25mm Stacked Patch Antenna Application Specification	SHEET No. 20 of 34
DOCUMENT NUMBER: AS-2122030001	CREATED / REVISED BY: Liu Hai 2019/04/16	CHECKED BY: Cheng Kang 2019/04/16	APPROVED BY: Andy Zhang 2019/04/16

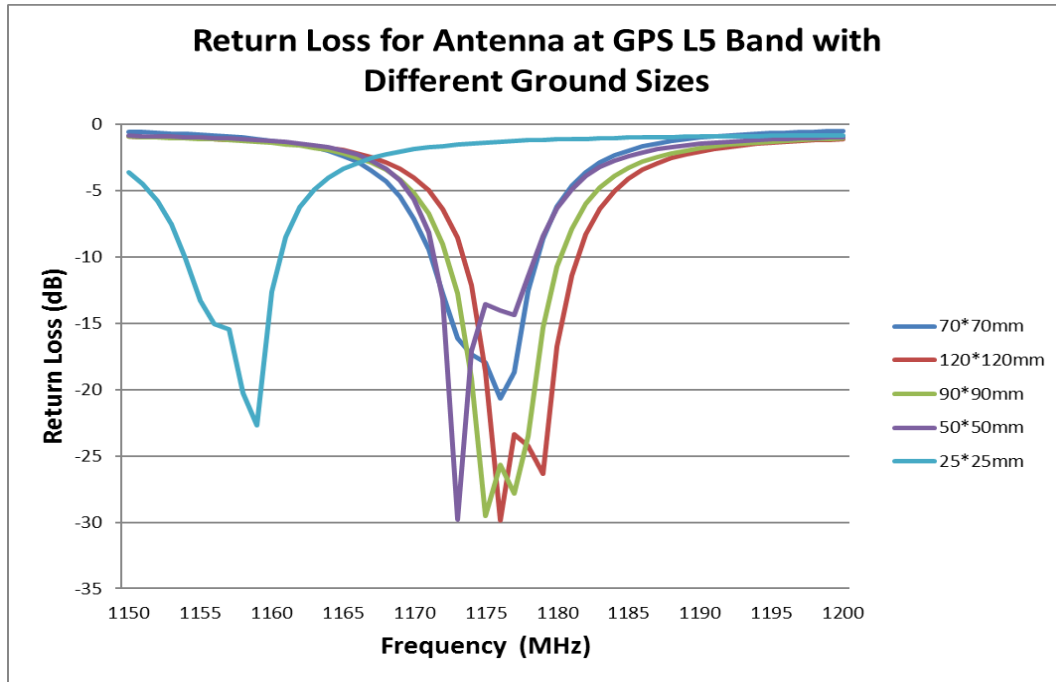

FIGURE 5.2.1 RETURN LOSS OF ANTENNA AT GPS L5 BAND WITH DIFFERENT GROUND SIZES

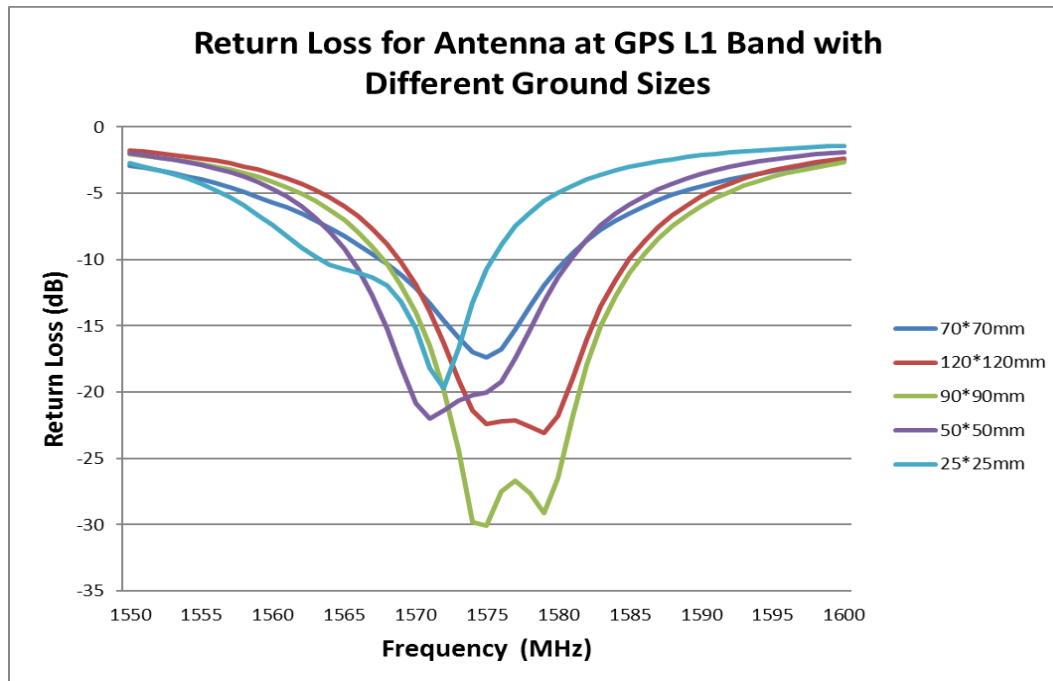

FIGURE 5.2.2 RETURN LOSS OF ANTENNA AT GPS L1 BAND WITH DIFFERENT GROUND SIZES

REVISION: A1	ECR/ECN INFORMATION: EC No: 616280 DATE: 2019/04/26	TITLE: GPS L1/L5 25mm Stacked Patch Antenna Application Specification	SHEET No. 21 of 34
DOCUMENT NUMBER: AS-2122030001	CREATED / REVISED BY: Liu Hai 2019/04/16	CHECKED BY: Cheng Kang 2019/04/16	APPROVED BY: Andy Zhang 2019/04/16

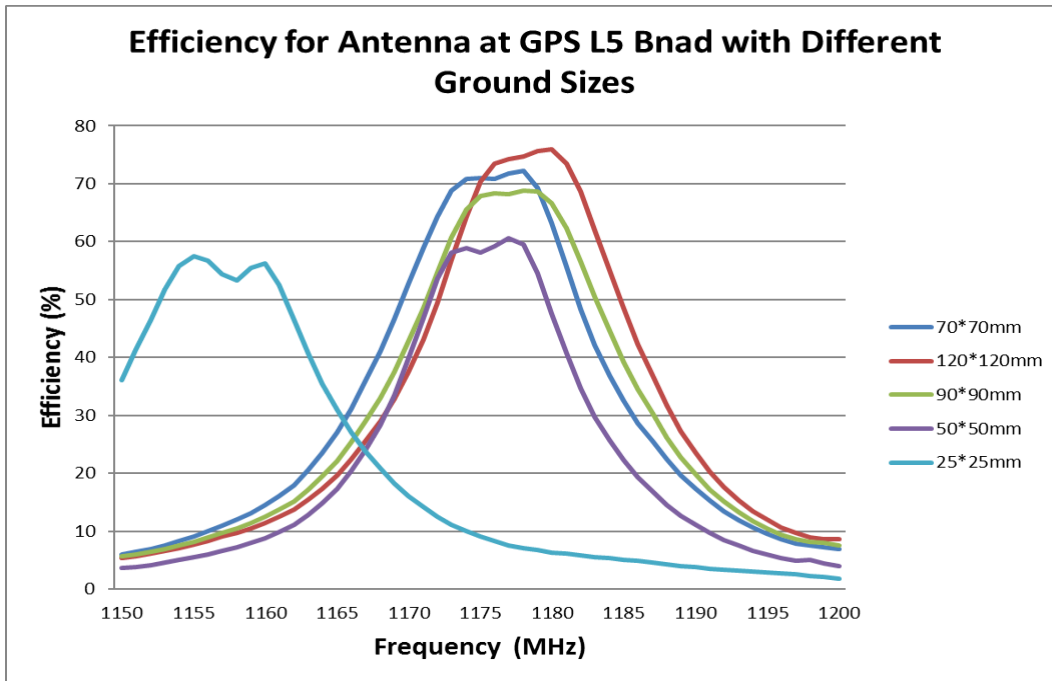

FIGURE 5.2.3 EFFICIENCY OF ANTENNA AT GPS L5 BAND WITH DIFFERENT GROUND SIZES

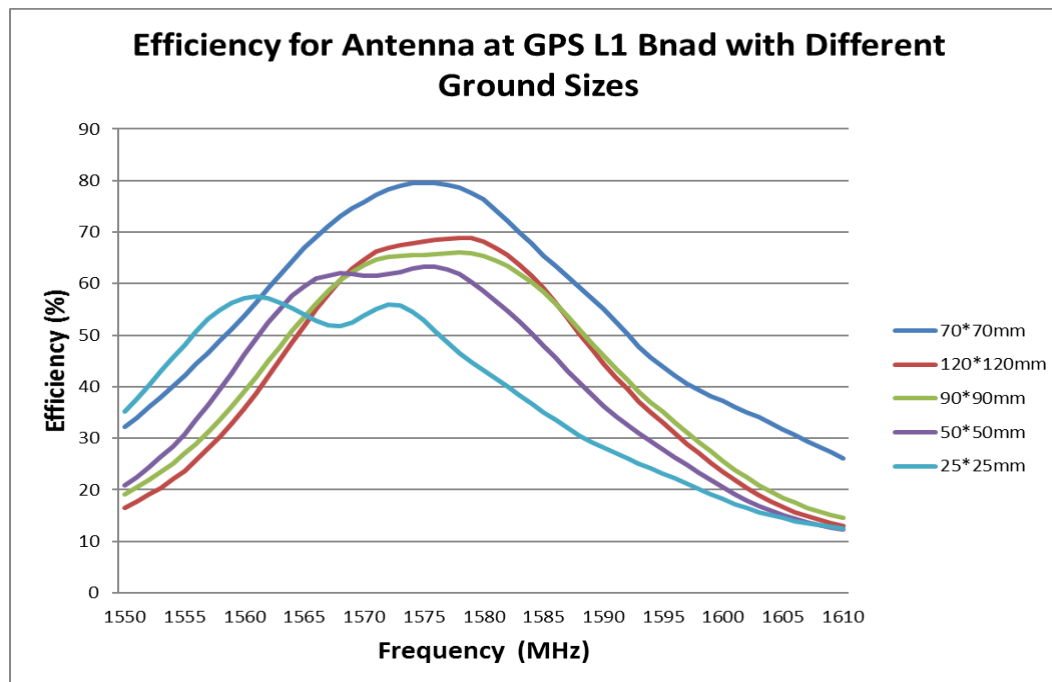

FIGURE 5.2.4 EFFICIENCY OF ANTENNA AT GPS L1 BAND WITH DIFFERENT GROUND SIZES

REVISION: A1	ECR/ECN INFORMATION: EC No: 616280 DATE: 2019/04/26	TITLE: GPS L1/L5 25mm Stacked Patch Antenna Application Specification	SHEET No. 22 of 34
DOCUMENT NUMBER: AS-2122030001	CREATED / REVISED BY: Liu Hai 2019/04/16	CHECKED BY: Cheng Kang 2019/04/16	APPROVED BY: Andy Zhang 2019/04/16

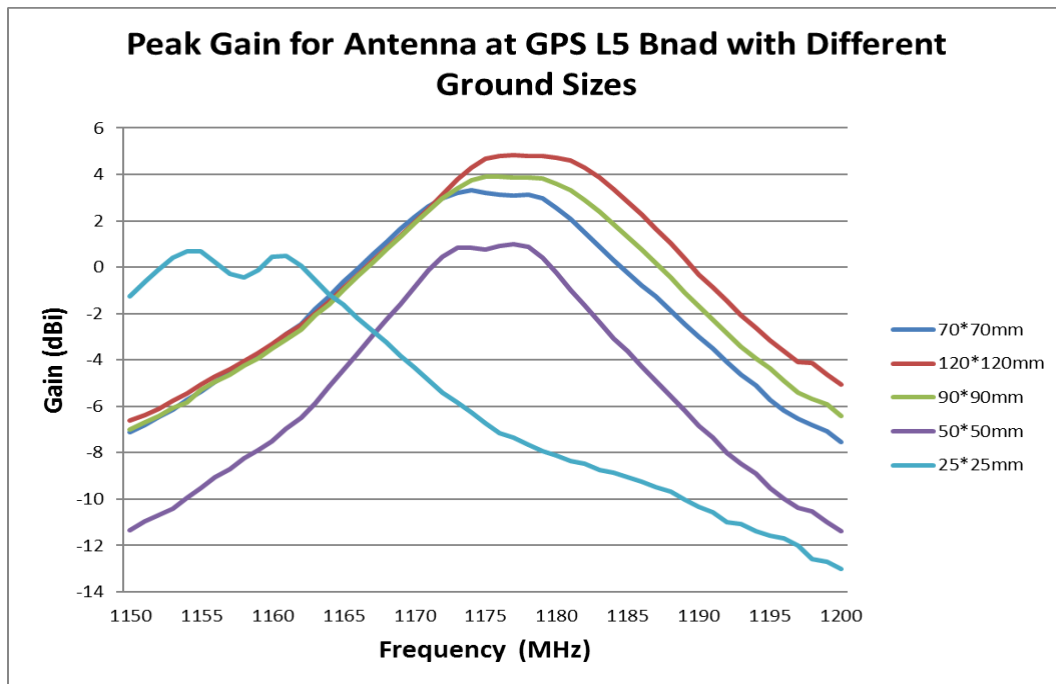

FIGURE 5.2.5 PEAK GAIN OF ANTENNA AT GPS L5 BAND WITH DIFFERENT GROUND SIZES

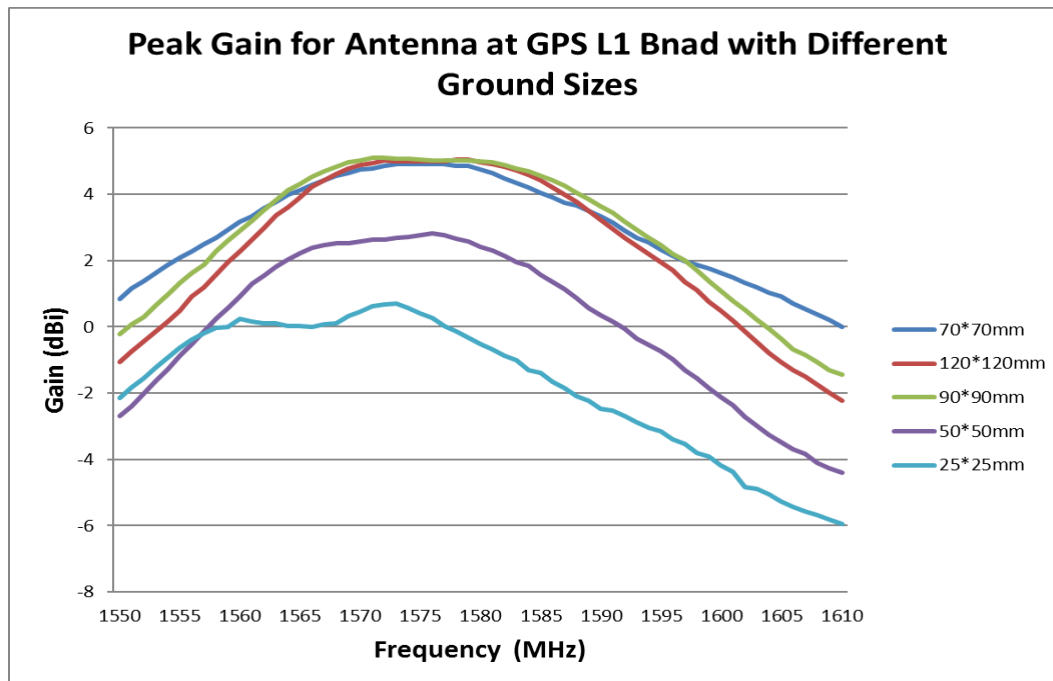

FIGURE 5.2.6 PEAK GAIN OF ANTENNA AT GPS L1 BAND WITH DIFFERENT GROUND SIZES

REVISION: A1	ECR/ECN INFORMATION: EC No: 616280 DATE: 2019/04/26	TITLE: GPS L1/L5 25mm Stacked Patch Antenna Application Specification	SHEET No. 23 of 34
DOCUMENT NUMBER: AS-2122030001	CREATED / REVISED BY: Liu Hai 2019/04/16	CHECKED BY: Cheng Kang 2019/04/16	APPROVED BY: Andy Zhang 2019/04/16

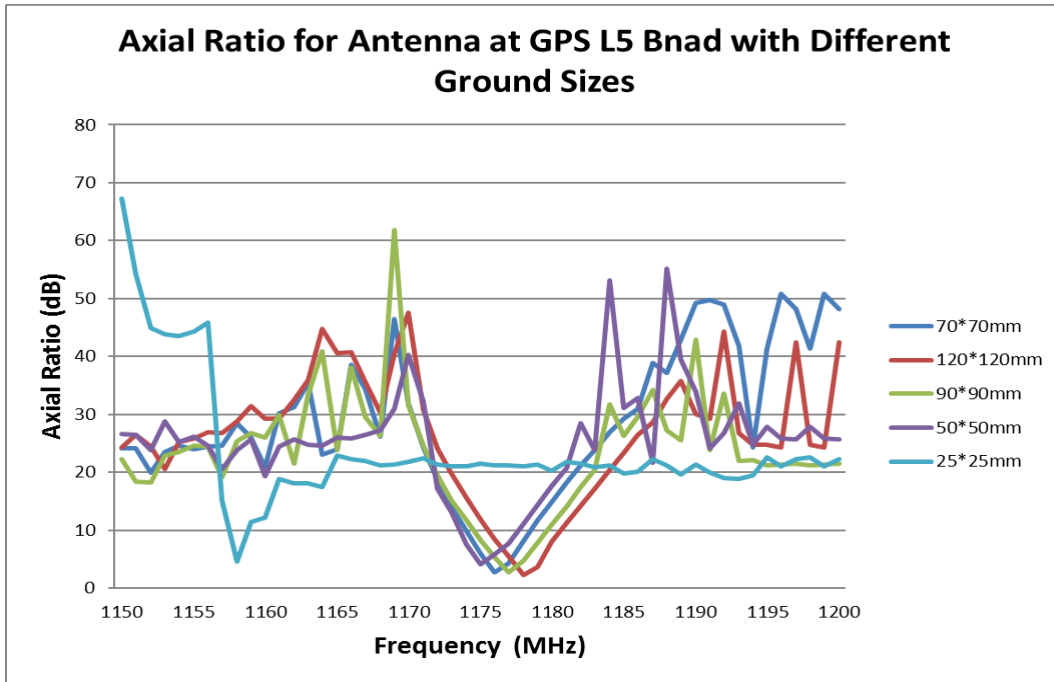

FIGURE 5.2.7 AXIAL RATIO OF ANTENNA AT GPS L5 BAND WITH DIFFERENT GROUND SIZES

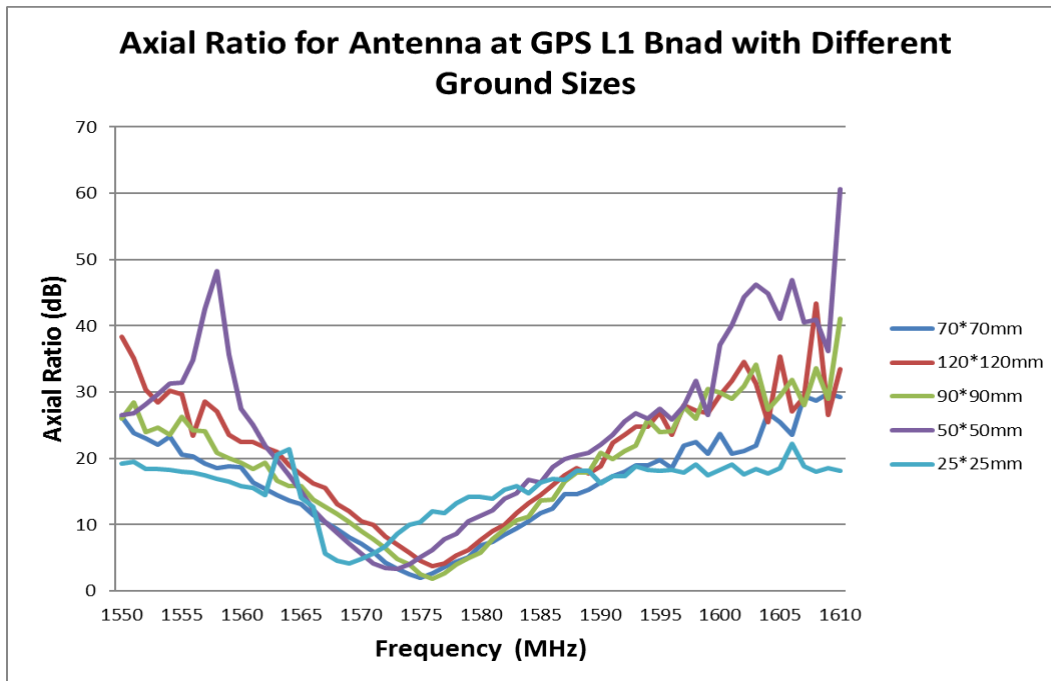

FIGURE 5.2.8 AXIAL RATIO OF ANTENNA AT GPS L1 BAND WITH DIFFERENT GROUND SIZES

REVISION: A1	ECR/ECN INFORMATION: EC No: 616280 DATE: 2019/04/26	TITLE: GPS L1/L5 25mm Stacked Patch Antenna Application Specification	SHEET No. 24 of 34
DOCUMENT NUMBER: AS-2122030001	CREATED / REVISED BY: Liu Hai 2019/04/16	CHECKED BY: Cheng Kang 2019/04/16	APPROVED BY: Andy Zhang 2019/04/16

5.3 RF PERFORMANCE AS A FUNCTION OF DIFFERENT DISTANCE BETWEEN VERTICAL METAL MATERIAL AND ANTENNA

An evaluation was done with 4 different distances from the antenna which is located at the recommended location to the vertical metal material (50mm x 4mm x 2mm). The 4 distances are as following: 1mm, 3mm, 5mm, 7mm.

From the study, we recommend that a metal material (50mm x 4mm x 2mm) should be placed at least 7mm away from the antenna. When the distance is less than 7mm, the antenna axial ratio will be degraded. Refer to figure 5.3.1-5.3.8.

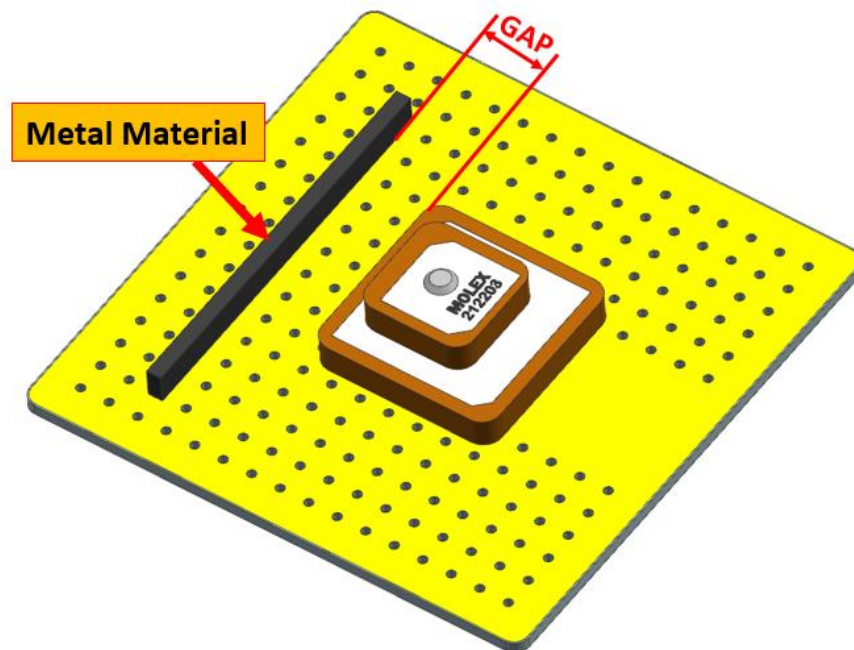

FIGURE 5.3.0 METAL MATERIAL FIXED ON REFERENCE PCB

Metal Material Size: 50mm*4mm*2mm;

Location 1: Distance between antenna and metal material (GAP) ground is about 1 mm;

Location 2: Distance between antenna and metal material (GAP) ground is about 3 mm;

Location 3: Distance between antenna and metal material (GAP) ground is about 5 mm;

Location 4: Distance between antenna and metal material (GAP) ground is about 7 mm;

REVISION: A1	ECR/ECN INFORMATION: EC No: 616280 DATE: 2019/04/26	TITLE: GPS L1/L5 25mm Stacked Patch Antenna Application Specification	SHEET No. 25 of 34
DOCUMENT NUMBER: AS-2122030001	CREATED / REVISED BY: Liu Hai 2019/04/16	CHECKED BY: Cheng Kang 2019/04/16	APPROVED BY: Andy Zhang 2019/04/16

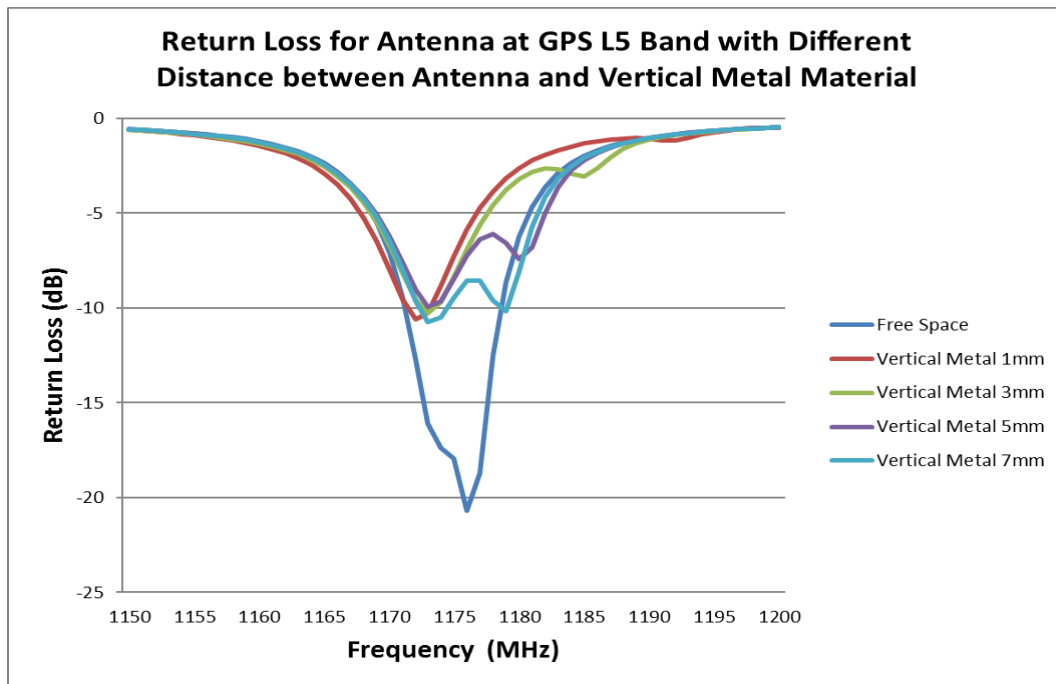

FIGURE 5.3.1 RETURN LOSS OF ANTENNA AT GPS L5 BAND AT DIFFERENT DISTANCES BETWEEN ANTENNA AND VERTICAL METAL MATERIAL

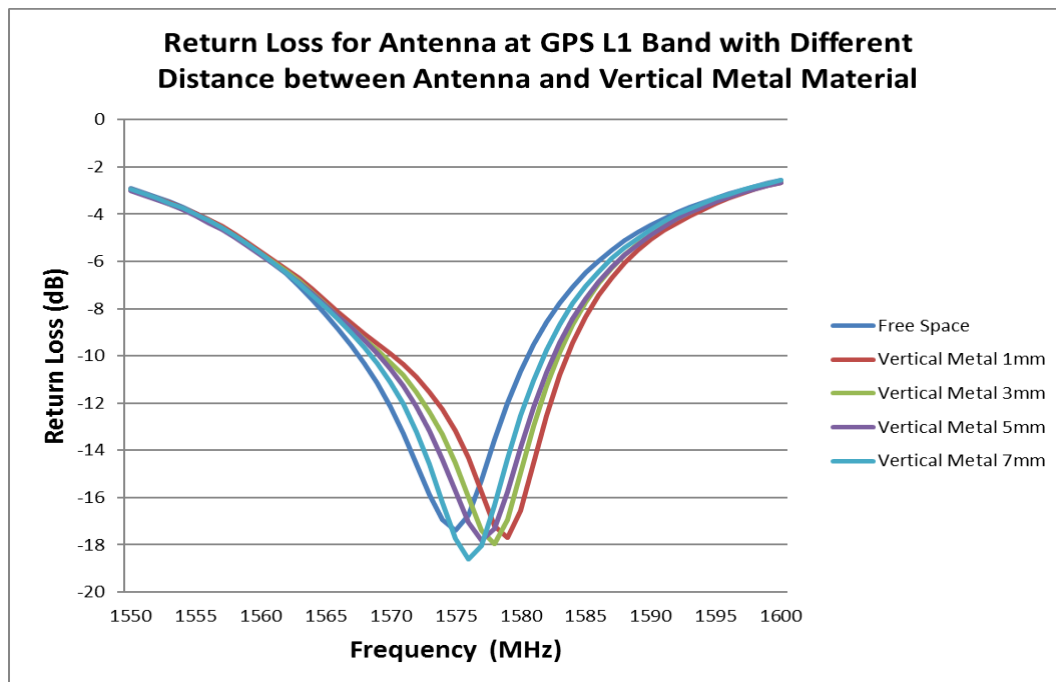

FIGURE 5.3.2 RETURN LOSS OF ANTENNA AT GPS L1 BAND AT DIFFERENT DISTANCES BETWEEN ANTENNA AND VERTICAL METAL MATERIAL

REVISION: A1	ECR/ECN INFORMATION: EC No: 616280 DATE: 2019/04/26	TITLE: GPS L1/L5 25mm Stacked Patch Antenna Application Specification	SHEET No. 26 of 34
DOCUMENT NUMBER: AS-2122030001	CREATED / REVISED BY: Liu Hai 2019/04/16	CHECKED BY: Cheng Kang 2019/04/16	APPROVED BY: Andy Zhang 2019/04/16

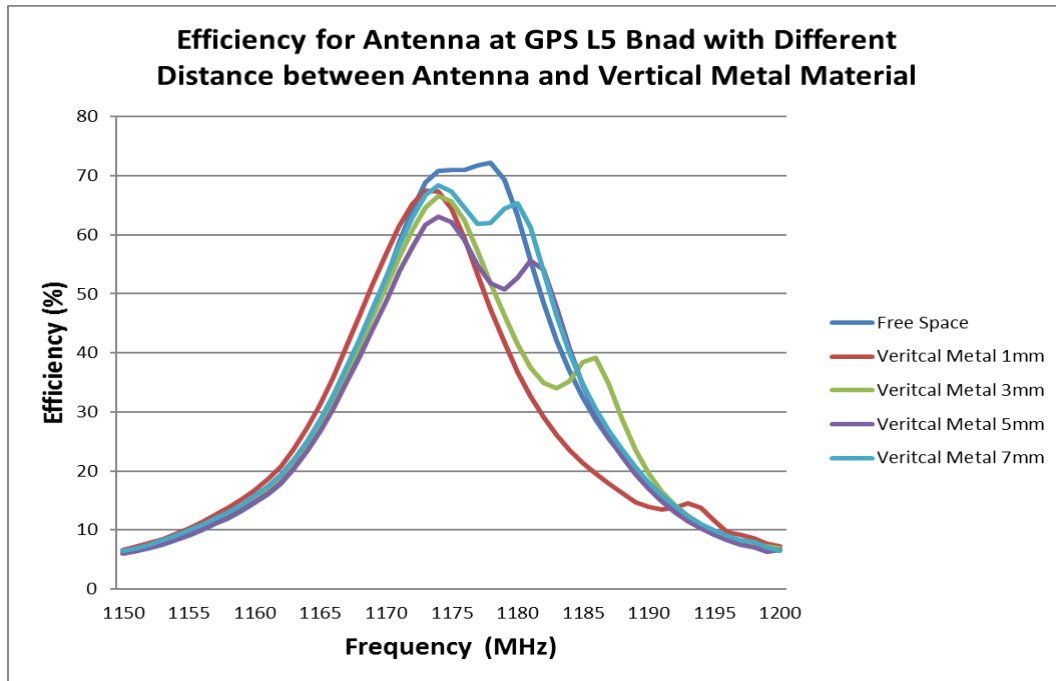

FIGURE 5.3.3 EFFICIENCY OF ANTENNA AT GPS L5 BAND AT DIFFERENT DISTANCES BETWEEN ANTENNA AND VERTICAL METAL MATERIAL

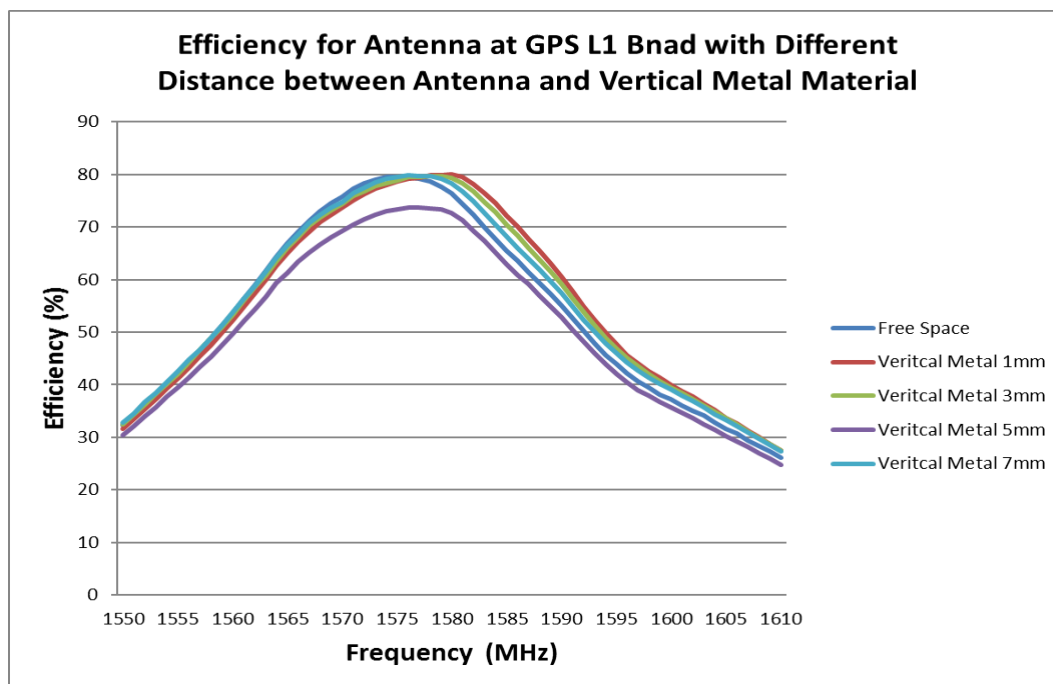

FIGURE 5.3.4 EFFICIENCY OF ANTENNA AT GPS L1 BAND AT DIFFERENT DISTANCES BETWEEN ANTENNA AND VERTICAL METAL MATERIAL

REVISION: A1	ECR/ECN INFORMATION: EC No: 616280 DATE: 2019/04/26	TITLE: GPS L1/L5 25mm Stacked Patch Antenna Application Specification	SHEET No. 27 of 34
DOCUMENT NUMBER: AS-2122030001	CREATED / REVISED BY: Liu Hai 2019/04/16	CHECKED BY: Cheng Kang 2019/04/16	APPROVED BY: Andy Zhang 2019/04/16

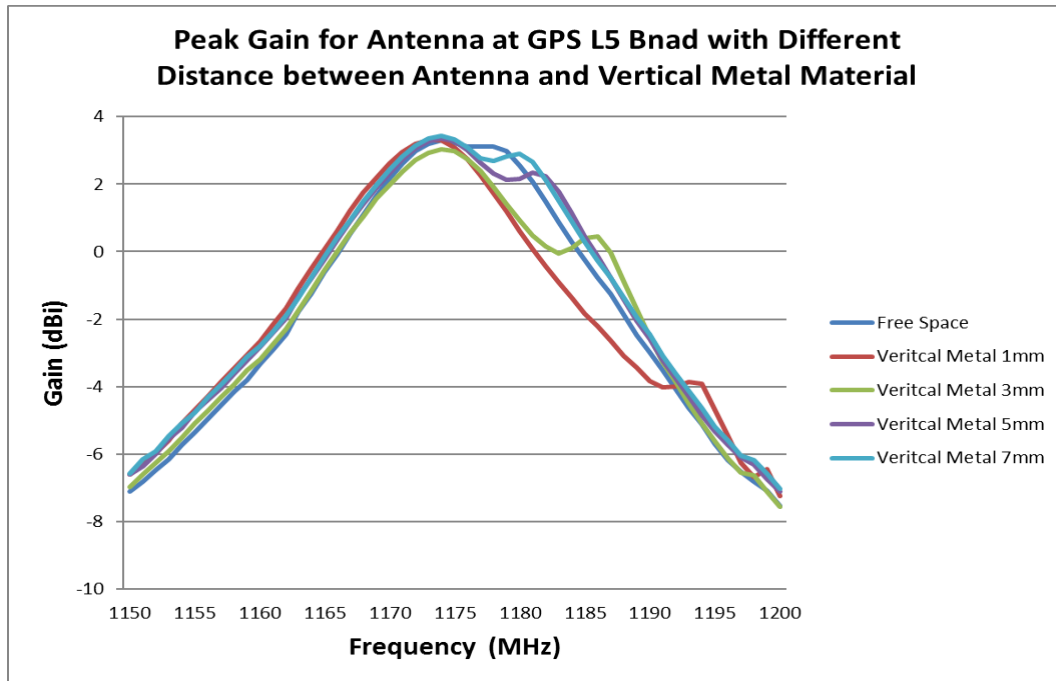

FIGURE 5.3.5 PEAK GAIN OF ANTENNA AT GPS L5 BAND AT DIFFERENT DISTANCES BETWEEN ANTENNA AND VERTICAL METAL MATERIAL

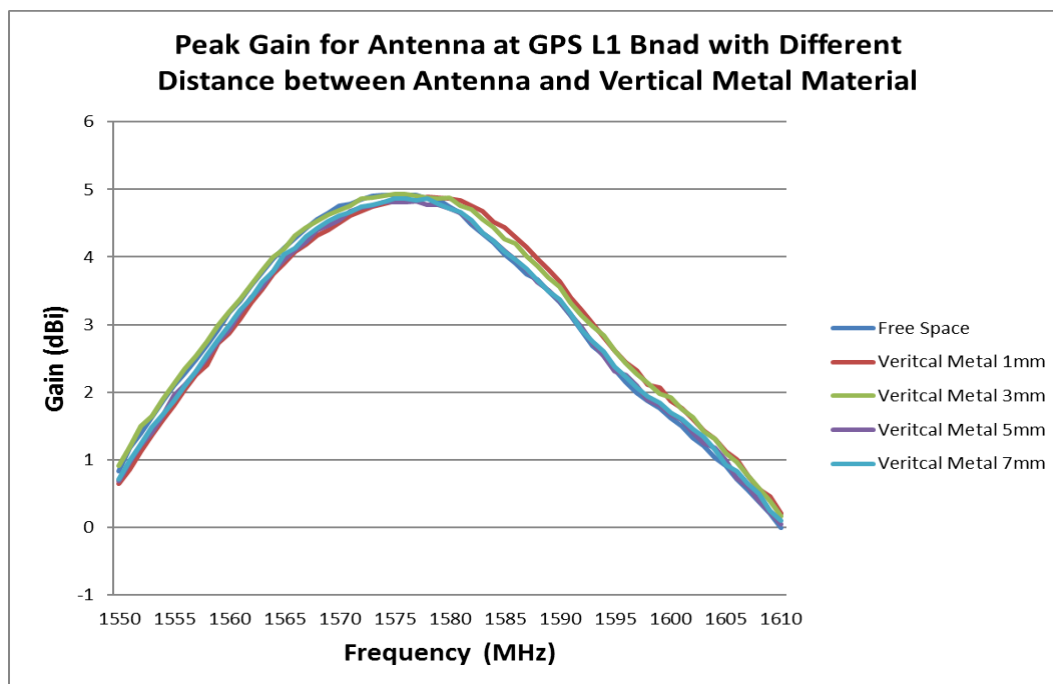

FIGURE 5.3.6 PEAK GAIN OF ANTENNA AT GPS L1 BAND AT DIFFERENT DISTANCES BETWEEN ANTENNA AND VERTICAL METAL MATERIAL

REVISION: A1	ECR/ECN INFORMATION: EC No: 616280 DATE: 2019/04/26	TITLE: GPS L1/L5 25mm Stacked Patch Antenna Application Specification	SHEET No. 28 of 34
DOCUMENT NUMBER: AS-2122030001	CREATED / REVISED BY: Liu Hai 2019/04/16	CHECKED BY: Cheng Kang 2019/04/16	APPROVED BY: Andy Zhang 2019/04/16

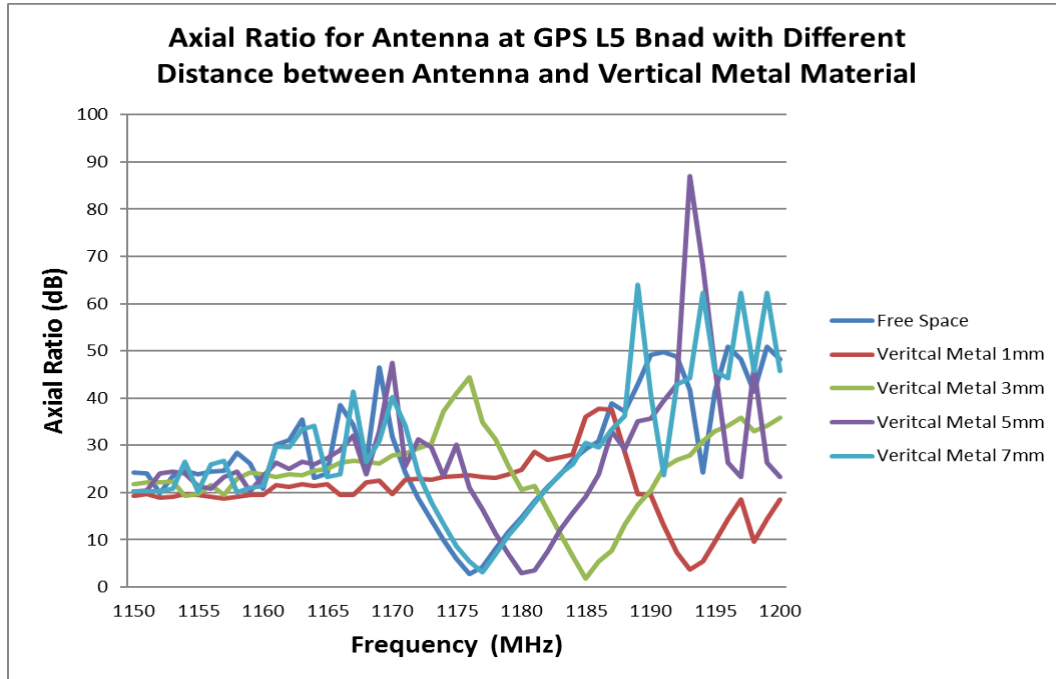

FIGURE 5.3.7 AXIAL RATIO OF ANTENNA AT GPS L5 BAND AT DIFFERENT DISTANCES BETWEEN ANTENNA AND VERTICAL METAL MATERIAL

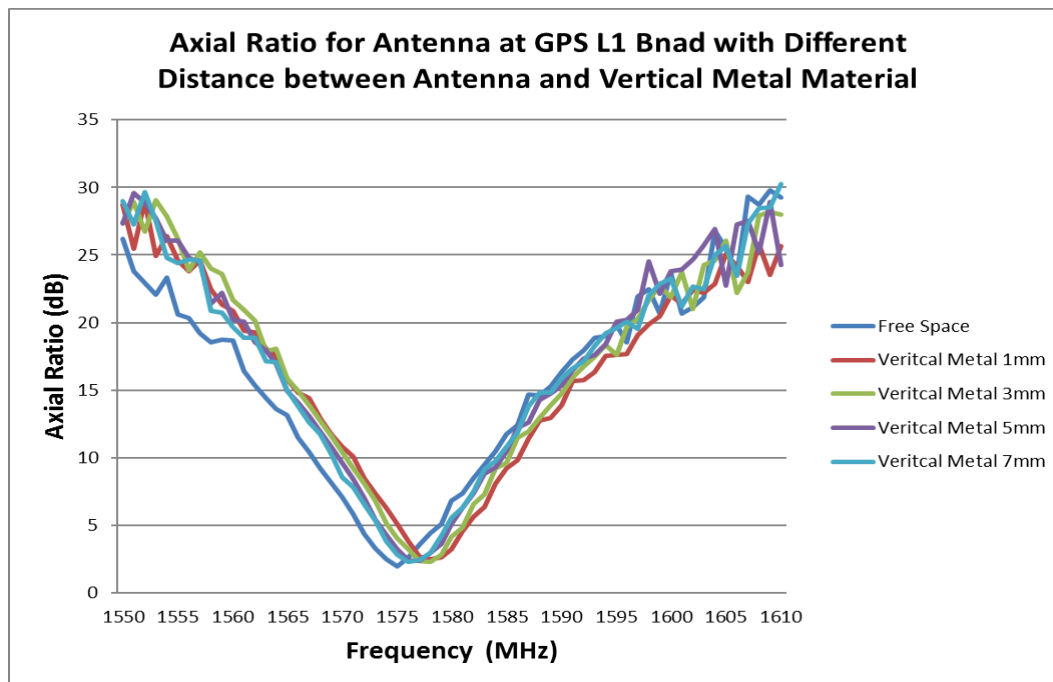

FIGURE 5.3.8 AXIAL RATIO OF ANTENNA AT GPS L1 BAND AT DIFFERENT DISTANCES BETWEEN ANTENNA AND VERTICAL METAL MATERIAL

REVISION: A1	ECR/ECN INFORMATION: EC No: 616280 DATE: 2019/04/26	TITLE: GPS L1/L5 25mm Stacked Patch Antenna Application Specification	SHEET No. 29 of 34
DOCUMENT NUMBER: AS-2122030001	CREATED / REVISED BY: Liu Hai 2019/04/16	CHECKED BY: Cheng Kang 2019/04/16	APPROVED BY: Andy Zhang 2019/04/16

5.4 RF PERFORMANCE AS A FUNCTION OF DIFFERENT DISTANCE BETWEEN HORIZONTAL PLASTIC COVER AND ANTENNA

An evaluation was done with 5 different distances from antenna to the horizontal plastic cover (50mm x 50mm x 2mm). The 5 distances are as following: 0mm、3mm、5mm、7mm.

From the study, we recommend that a plastic cover (50mm x 50mm x 2mm) should be placed at least 3mm away from the antenna. When the distance is less than 3mm, the antenna performance will be deviation. Refer to figure 5.4.1-5.4.8.

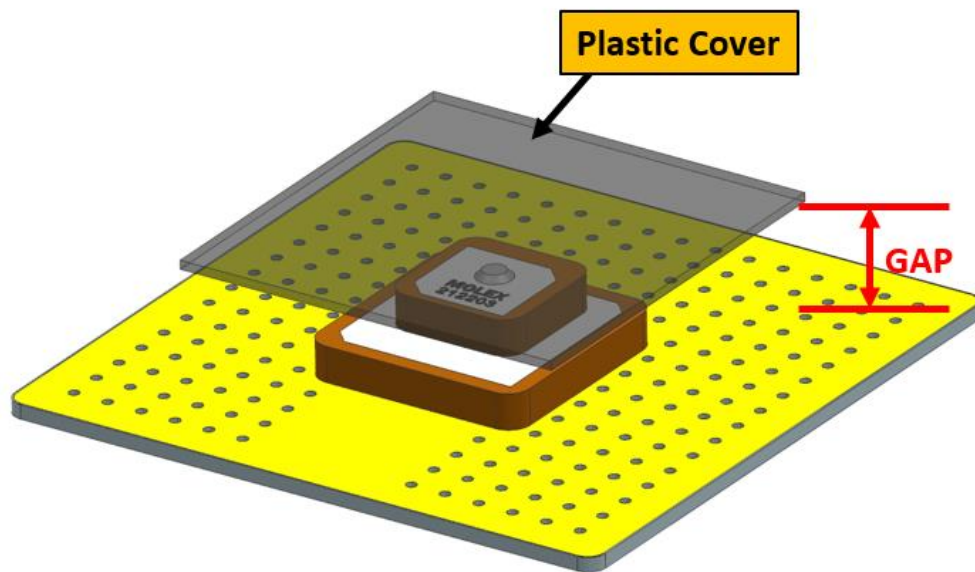

FIGURE 6.4 PLASTIC COVER POSITIONS

Plastic Cover Size: 50mm*50mm*2mm;

Location 1: Distance between PCB and plastic cover (GAP) ground is about 0 mm;

Location 2: Distance between PCB and plastic cover (GAP) ground is about 3 mm;

Location 3: Distance between PCB and plastic cover (GAP) ground is about 5 mm;

Location 4: Distance between PCB and plastic cover (GAP) ground is about 7 mm;

REVISION: A1	ECR/ECN INFORMATION: EC No: 616280 DATE: 2019/04/26	TITLE: GPS L1/L5 25mm Stacked Patch Antenna Application Specification	SHEET No. 30 of 34
DOCUMENT NUMBER: AS-2122030001	CREATED / REVISED BY: Liu Hai 2019/04/16	CHECKED BY: Cheng Kang 2019/04/16	APPROVED BY: Andy Zhang 2019/04/16

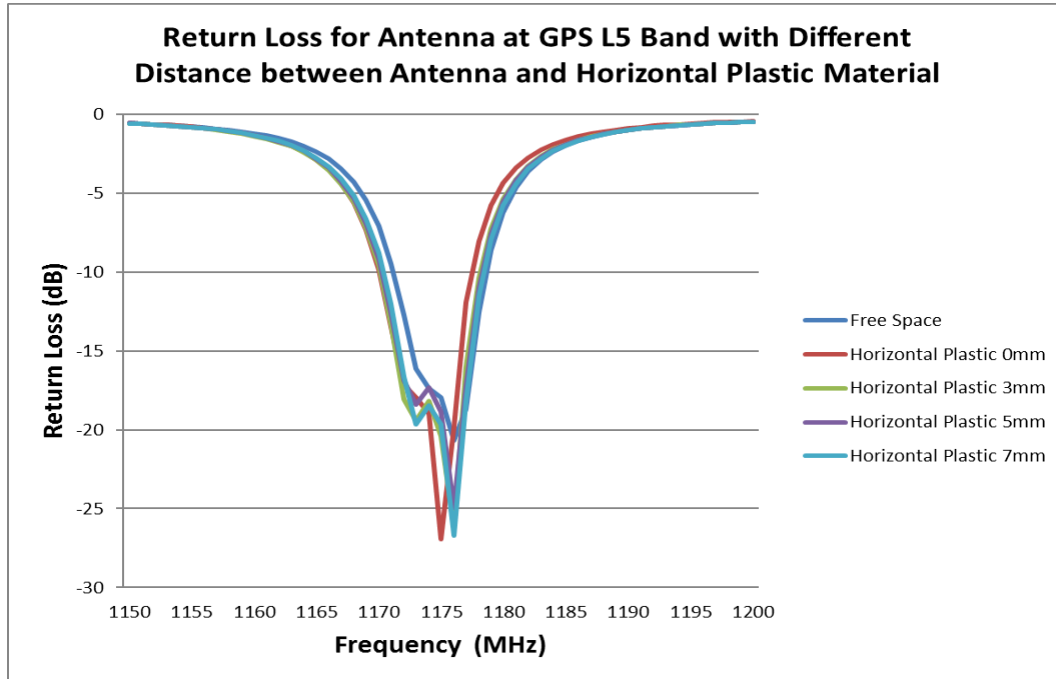

FIGURE 5.4.1 RETURN LOSS OF ANTENNA AT GPS L5 BAND AT DIFFERENT DISTANCES BETWEEN ANTENNA AND HORIZONTAL PLASTIC MATERIAL

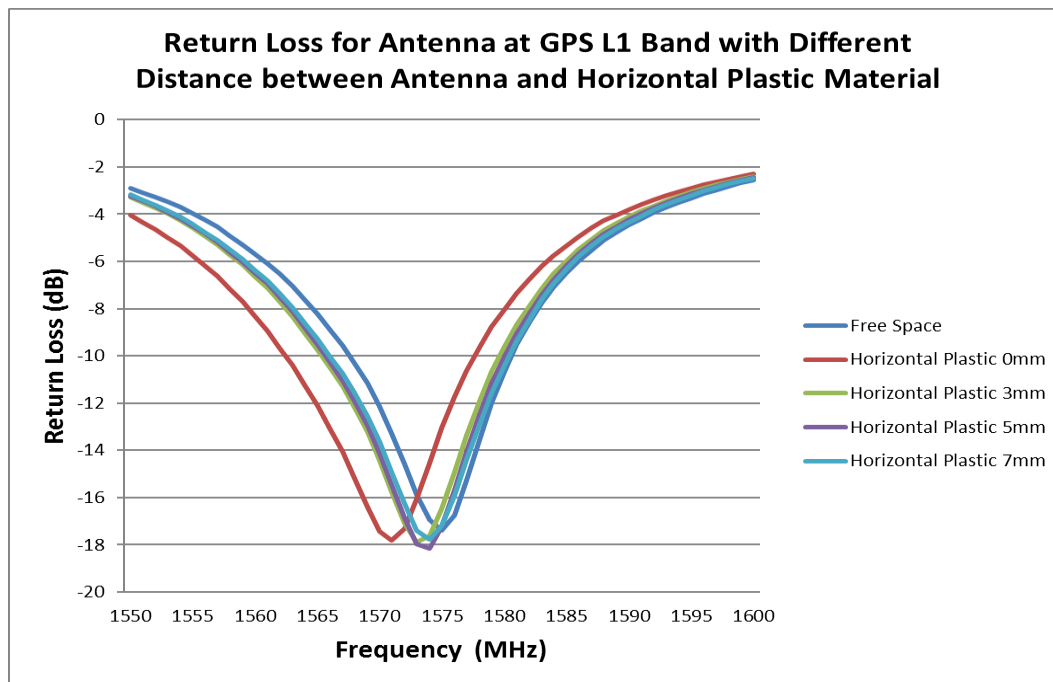

FIGURE 5.4.2 RETURN LOSS OF ANTENNA AT GPS L1 BAND AT DIFFERENT DISTANCES BETWEEN ANTENNA AND HORIZONTAL PLASTIC MATERIAL

REVISION: A1	ECR/ECN INFORMATION: EC No: 616280 DATE: 2019/04/26	TITLE: GPS L1/L5 25mm Stacked Patch Antenna Application Specification	SHEET No. 31 of 34
DOCUMENT NUMBER: AS-2122030001	CREATED / REVISED BY: Liu Hai 2019/04/16	CHECKED BY: Cheng Kang 2019/04/16	APPROVED BY: Andy Zhang 2019/04/16

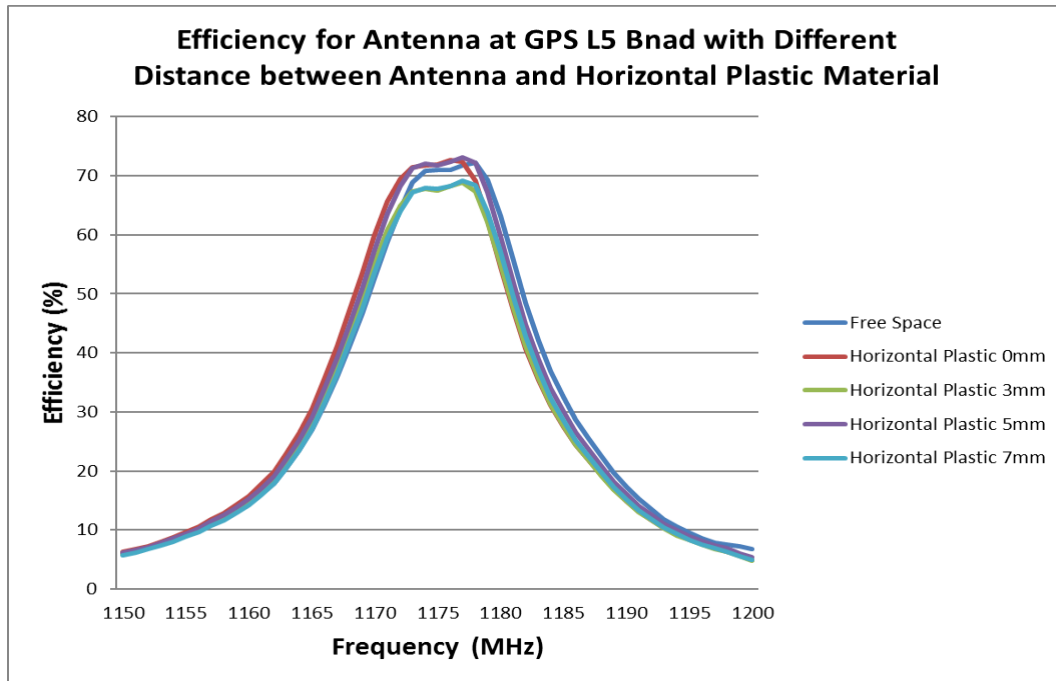

FIGURE 5.4.3 EFFICIENCY OF ANTENNA AT GPS L5 BAND AT DIFFERENT DISTANCES BETWEEN ANTENNA AND HORIZONTAL PLASTIC MATERIAL

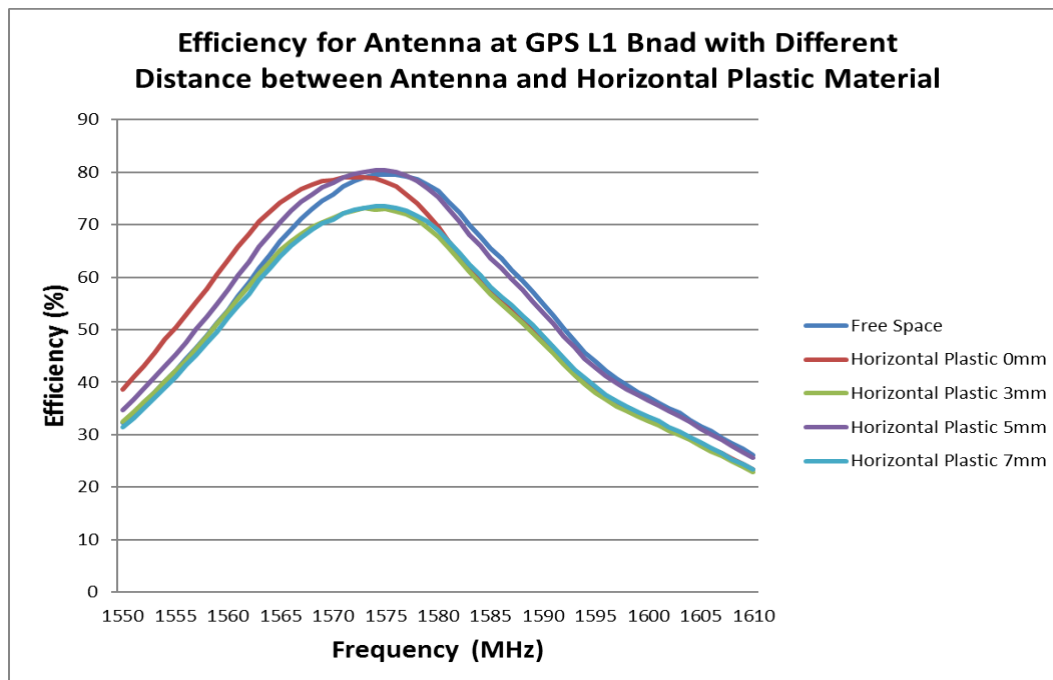

FIGURE 5.4.4 EFFICIENCY OF ANTENNA AT GPS L1 BAND AT DIFFERENT DISTANCES BETWEEN ANTENNA AND HORIZONTAL PLASTIC MATERIAL

REVISION: A1	ECR/ECN INFORMATION: EC No: 616280 DATE: 2019/04/26	TITLE: GPS L1/L5 25mm Stacked Patch Antenna Application Specification	SHEET No. 32 of 34
DOCUMENT NUMBER: AS-2122030001	CREATED / REVISED BY: Liu Hai 2019/04/16	CHECKED BY: Cheng Kang 2019/04/16	APPROVED BY: Andy Zhang 2019/04/16

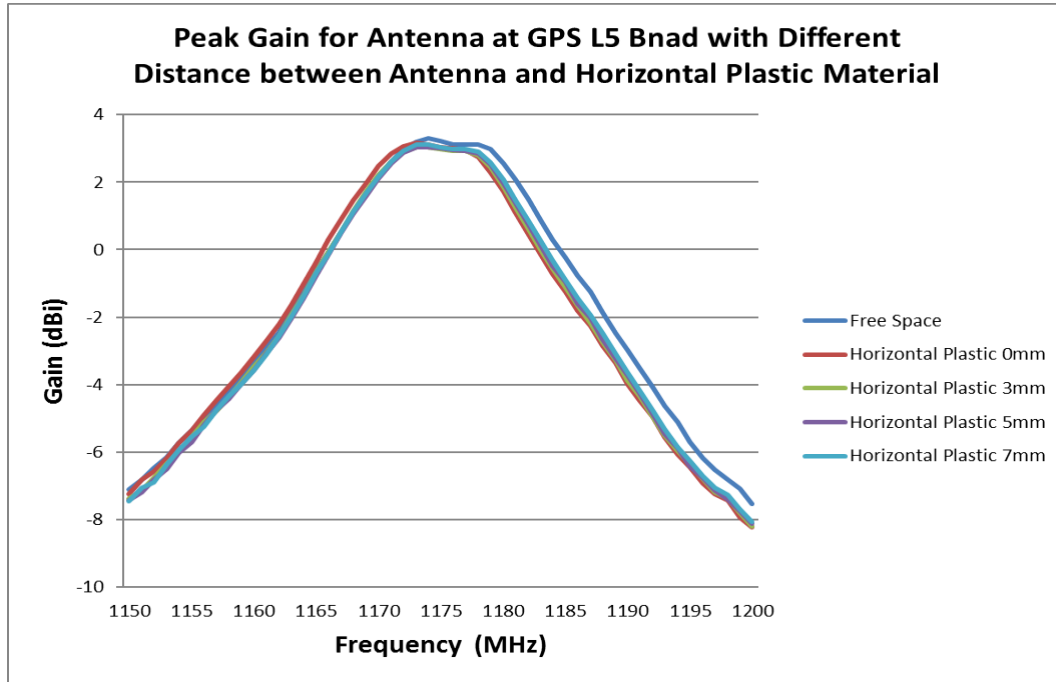

FIGURE 5.4.5 PEAK GAIN OF ANTENNA AT GPS L5 BAND AT DIFFERENT DISTANCES BETWEEN ANTENNA AND HORIZONTAL PLASTIC MATERIAL

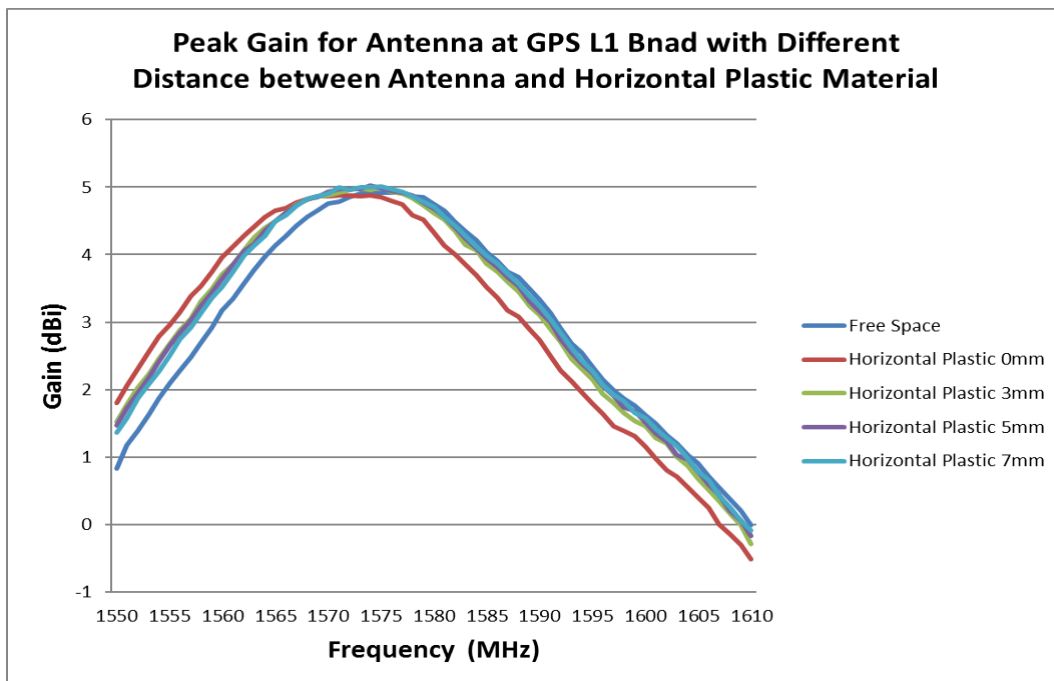

FIGURE 5.4.6 PEAK GAIN OF ANTENNA AT GPS L1 BAND AT DIFFERENT DISTANCES BETWEEN ANTENNA AND HORIZONTAL PLASTIC MATERIAL

REVISION: A1	ECR/ECN INFORMATION: EC No: 616280 DATE: 2019/04/26	TITLE: GPS L1/L5 25mm Stacked Patch Antenna Application Specification	SHEET No. 33 of 34
DOCUMENT NUMBER: AS-2122030001	CREATED / REVISED BY: Liu Hai 2019/04/16	CHECKED BY: Cheng Kang 2019/04/16	APPROVED BY: Andy Zhang 2019/04/16

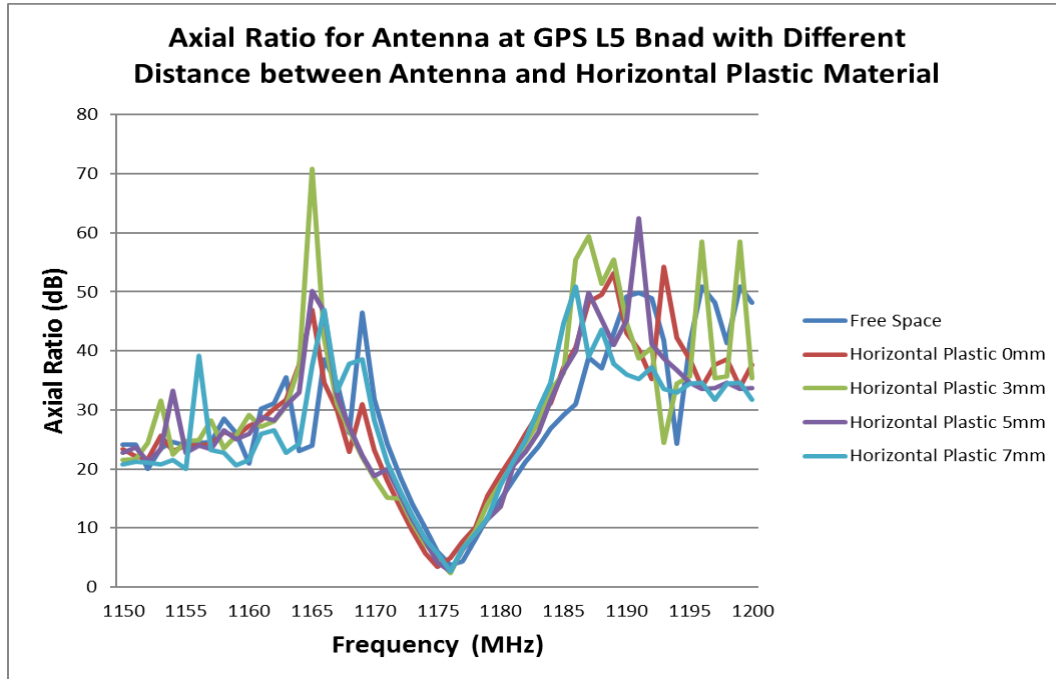

FIGURE 5.4.7 AXIAL RATIO OF ANTENNA AT GPS L5 BAND AT DIFFERENT DISTANCES BETWEEN ANTENNA AND HORIZONTAL PLASTIC MATERIAL

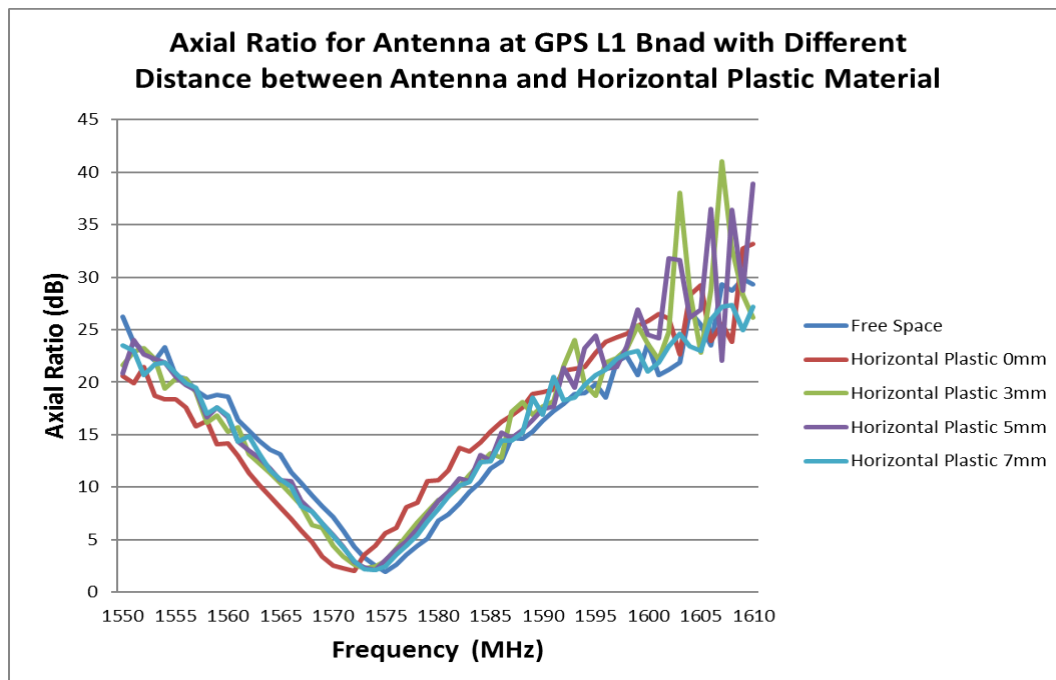

FIGURE 5.4.8 AXIAL RATIO OF ANTENNA AT GPS L1 BAND AT DIFFERENT DISTANCES BETWEEN ANTENNA AND HORIZONTAL PLASTIC MATERIAL

REVISION: A1	ECR/ECN INFORMATION: EC No: 616280 DATE: 2019/04/26	TITLE: GPS L1/L5 25mm Stacked Patch Antenna Application Specification	SHEET No. 34 of 34
DOCUMENT NUMBER: AS-2122030001	CREATED / REVISED BY: Liu Hai 2019/04/16	CHECKED BY: Cheng Kang 2019/04/16	APPROVED BY: Andy Zhang 2019/04/16