



**SPECIFICATION SHEET**

<b>SPECIFICATION SHEET NO.</b>	N1230- SMCSK840000S84
<b>DATE</b>	Dec.30, 2021
<b>REVISION</b>	A0
<b>DESCRIPTION</b>	SMD Schottky Barrier Rectifier, 2 Pads, SMC/DO-214AB series, SK84C Type Reverse Voltage 40V Max. Forward Current 8A Max. Operating Temp. Range -55°C ~+150°C, Package in Tape/Reel, 3000pcs/Reel RoHS/RoHS III compliant
<b>CUSTOMER</b>	
<b>CUSTOMER PART NUMBER</b>	
<b>CROSS REF. PART NUMBER</b>	
<b>ORIGINAL PART NUMBER</b>	MDD SK84C
<b>PART CODE</b>	SMCSK840000S84

<b>VENDOR APPROVE</b>			
Issued/Checked/Approved			
DATE: Dec.30, 2021			

<b>CUSTOMER APPROVE</b>	
DATE:	

1/15/2022

**SMD SCHOTTKY BARRIER RECTIFIER SMC SERIES**



**MAIN FEATURE**

- The plastic package carries Underwriters Laboratory Flammability Classification 94V-0
- Low reverse leakage
- Built-in strain relief
- Low power loss, high efficiency
- High forward surge current capability
- High temperature soldering guaranteed: 250°C/ 10 seconds at terminals
- Metal silicon junction, majority carrier conduction

**APPLICATION**

- For surface mounted applications

**RFQ**

[Request For Quotation](#)

**PART CODE GUIDE**

<b>SMC</b>	<b>SK840000</b>	<b>S</b>	<b>84</b>
1	2	3	4

- 1) **SMC**: SMD Schottky Barrier Rectifier, 2 Pads, Package SMC/DO-214AB series
- 2) **SK840000**: Type code for original part number SK84C
- 3) **S**: Package code, Tape/Reel, 3000pcs/reel.
- 4) **84**: Specification code for Reverse Voltage 40V Max. Forward Current 8A Max.

**SMD SCHOTTKY BARRIER RECTIFIER SMC SERIES**

**DIMENSION (Unit: Inch/mm)**

Image for reference



Marking: SK84C

SMC/DO-214AB

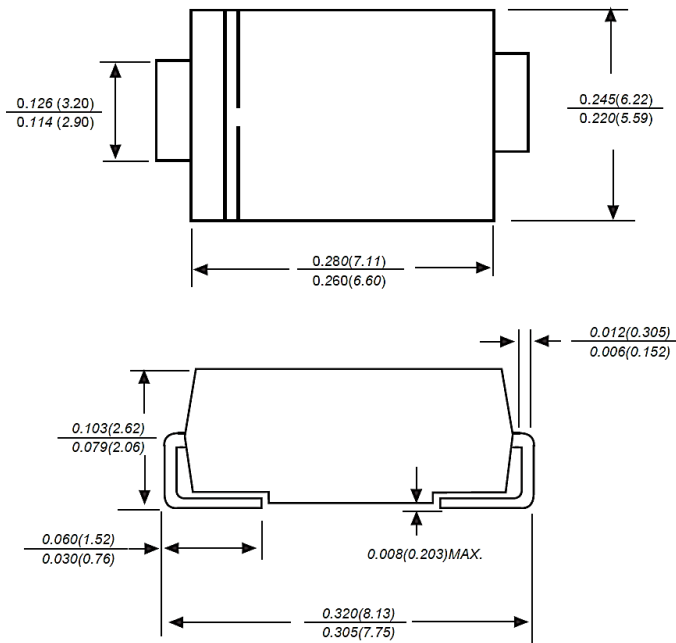

Recommend Pad Layout

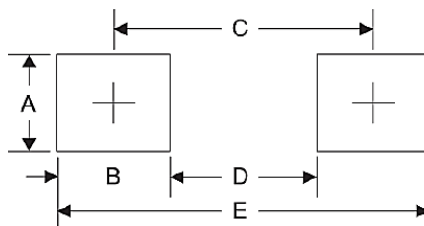

Symbol	Unit (inch)	Unit (mm)
A	0.170	4.30
B	0.160	4.10
C	0.311	7.90
D	0.150	3.80
E	0.472	12.0

**SMD SCHOTTKY BARRIER RECTIFIER SMC SERIES**
**MECHANICAL DATA**

Case	Terminals	Polarity	Mounting Position	Weight per piece
JEDEC SMC/DO-214AB molded plastic body	Solder plated, Solderable per MIL-STD-750, Method 2026	Polarity symbol marking on case	Any	0.0070 Ounce, 0.2180 grams

**MAX. RATING & CHARACTERISTICS**

Parameter	SYMBOLS	VALUE			UNITS
		Min.	Typical	Max.	
Repetitive peak reverse voltage	V <sub>RRM</sub>			40	Volts
RMS voltage	V <sub>RMS</sub>			28	Volts
DC blocking voltage	V <sub>DC</sub>			40	Volts
Average forward output rectified current at TL (see fig.1)	I <sub>AV</sub>			8.0	A
Peak forward surge current 8.3ms single half sine-wave superimposed on rated load (JEDEC Method)	I <sub>FSM</sub>		150		A
Instantaneous forward voltage at 8.0A	V <sub>F</sub>			0.55	Volts
DC reverse current at rated DC blocking voltage	I <sub>R</sub>			1.0	mA
				50	mA
Junction capacitance (NOTE 2)	C <sub>J</sub>		900		pF
Thermal resistance (Note 3)	R <sub>QJA</sub>		35		°C/W
Operating junction temperature range	T <sub>J</sub>	-55		+150	°C
Storage temperature range	T <sub>STG</sub>	-55		+150	°C

**Note**

1. Ratings at 25 C ambient temperature unless otherwise specified. Single phase half-wave 60Hz, resistive or inductive load, for capacitive load current derate by 20%.
2. Measured at 1.0MHz and applied reverse voltage of 4.0Voltage
3. P.C.B. mounted with 0.2x0.2"(5.0x5.0mm) copper pad areas.

**SMD SCHOTTKY BARRIER RECTIFIER SMC SERIES**
**RELIABILITY**

Number	Experiment Items	Experiment Method And Conditions	Reference Documents
1	Solder Resistance Test	Test 250°C± 5°C for 10 ± 2 sec. Immerse body into solder 1/16" ± 1/32"	MIL-STD-750D METHOD-2031.2
2	Solderability Test	230°C ±5°C for 5 sec.	MIL-STD-750D METHOD-2026.1 0
3	Pull Test	1 kg in axial lead direction for 10 sec.	MIL-STD-750D METHOD-2036.4
4	Bend Test	0.5Kg Weight Applied To Each Lead, Bending Arcs 90 °C ± 5 °C For 3 Times	MIL-STD-750D METHOD-2036.4
5	High Temperature Reverse Bias Test	TA=100°C for 1000 Hours at VR=80% Rated VR	MIL-STD-750D METHOD-1038.4
6	Forward Operation Life Test	TA=25°C Rated Average Rectified Current	MIL-STD-750D METHOD-1027.3
7	Intermittent Operation Life Test	On state: 5 min with rated IRMS Power Off state: 5 min with Cool Forced Air. On and off for 1000 cycles.	MIL-STD-750D METHOD-1036.3
8	Pressure Cooker Test	15 PSIG, TA=121°C, 4 hours	MIL-S-19500 APPENOIXC
9	Temperature Cycling Test	-55°C~+125°C; 30 Minutes For Dwelled Time 5 minutes for transferred time. Total: 10 cycles.	MIL-STD-750D METHOD-1051.7
10	Thermal Shock Test	0°C for 5 minutes., 100°C for 5minutes, Total: 10 cycles	MIL-STD-750D METHOD-1056.7
11	Forward Surge Test	8.3ms Single Sale Sine-wave One Surge.	MIL-STD-750D METHOD-4066.4
12	Humidity Test	TA=65°C, RH=98% for 1000 hours.	MIL-STD-750D METHOD-1021.3
13	High Temperature Storage life Test	150°C for 1000 Hours	MIL-STD-750D METHOD-1031.5

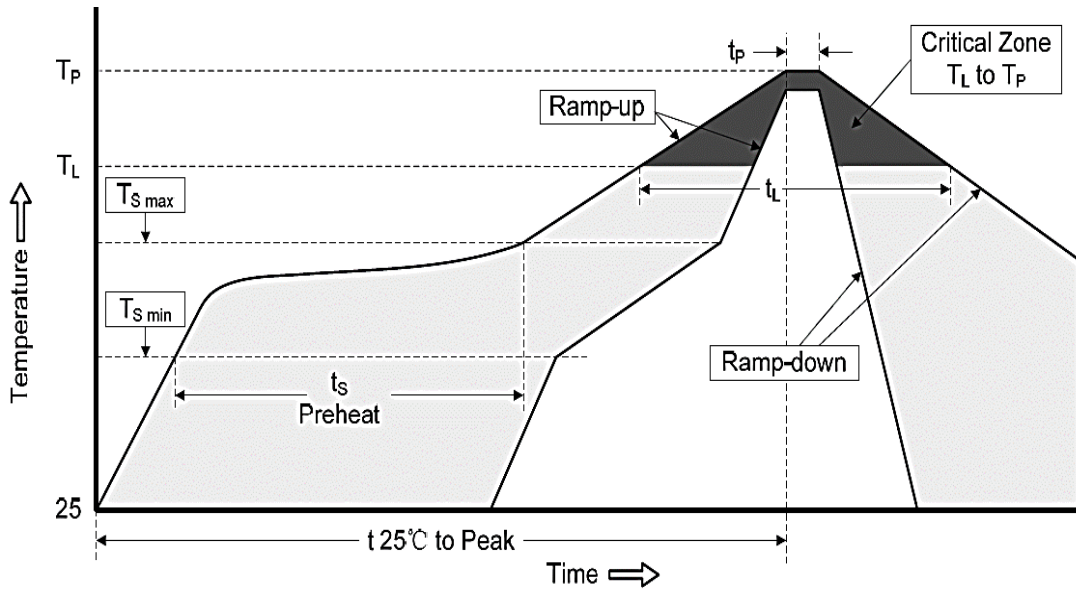
**SMD SCHOTTKY BARRIER RECTIFIER SMC SERIES**
**SUGGESTED REFLOW PROFILE (For Reference Only)**

<b>Profile Feature</b>		Pb-Free Assembly
<b>Average Ramp-up Rate (<math>T_S</math> Max to <math>T_P</math>)</b>		3°C/second Max
<b>Preheat</b>	<b>Temperature Min (<math>T_S</math> Min.)</b>	150°C
	<b>Temperature Max (<math>T_S</math> Max.)</b>	200°C
	<b>Time (<math>t_s</math> Min. to <math>t_s</math> Max.)</b>	60 ~ 180 seconds
<b>Time maintained above</b>	<b>Temperature (<math>T_L</math>)</b>	217°C
	<b>Time (<math>t_L</math>)</b>	60 ~ 150 seconds
<b>Peak/Classification Temperature (<math>T_P</math>)</b>		250 °C
<b>Time within 5°C of actual Peak Temperature (<math>t_p</math>)</b>		10 seconds
<b>Ramp-down rate</b>		6 °C /Second Max.
<b>Time 25 °C to Peak Temperature</b>		6 minutes Max.
<b>Suggest reflow times</b>		3 Times Max.

**SMD SCHOTTKY BARRIER RECTIFIER SMC SERIES**

**RATINGS AND CHARACTERISTIC CURVES (For Reference Only)**

Fig.1 Forward Current Derating Curve

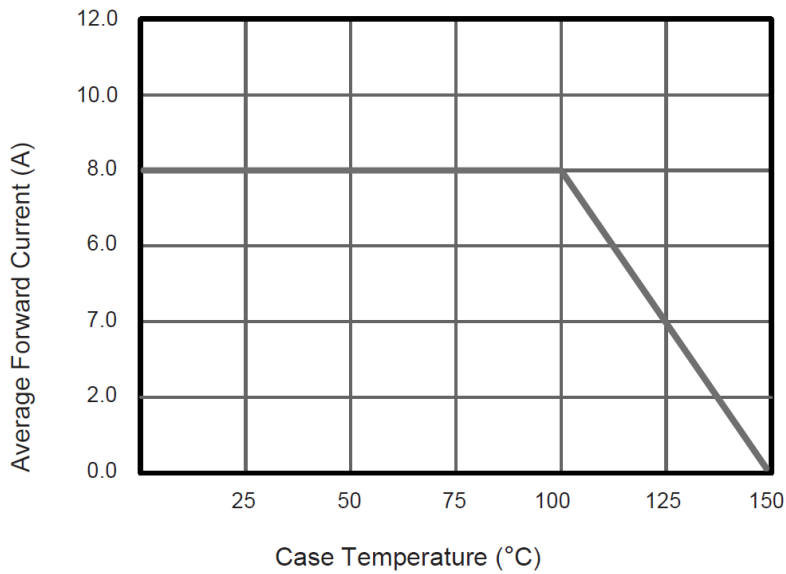
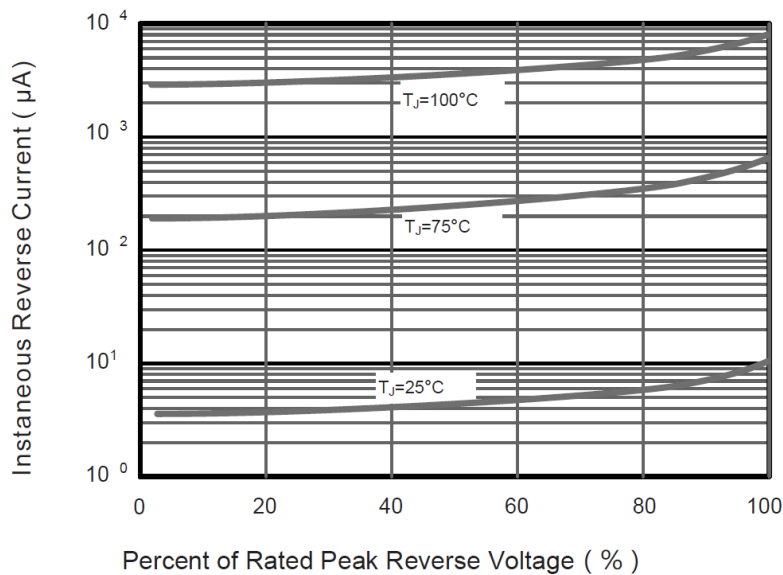

Fig.2 Typical Reverse Characteristics



**SMD SCHOTTKY BARRIER RECTIFIER SMC SERIES**

**RATINGS AND CHARACTERISTIC CURVES (For Reference Only)**

Fig.3 Typical Forward Characteristic

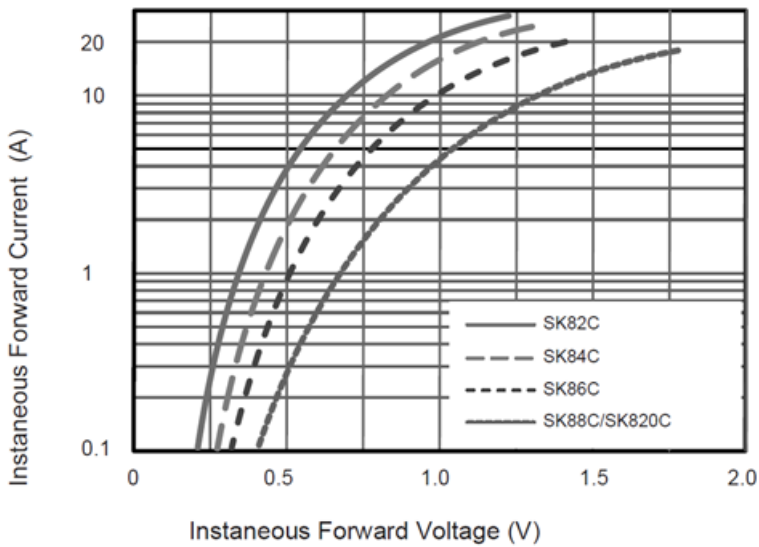
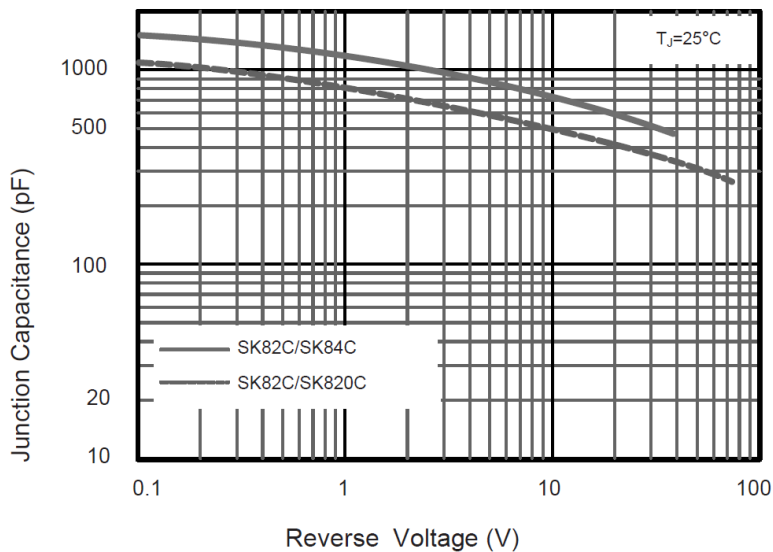

Fig.4 Typical Junction Capacitance





**SMD SCHOTTKY BARRIER RECTIFIER SMC SERIES**

**RATINGS AND CHARACTERISTIC CURVES (For Reference Only)**

**Fig.5 Maximum Non-Repetitive Peak Forward Surge Current**

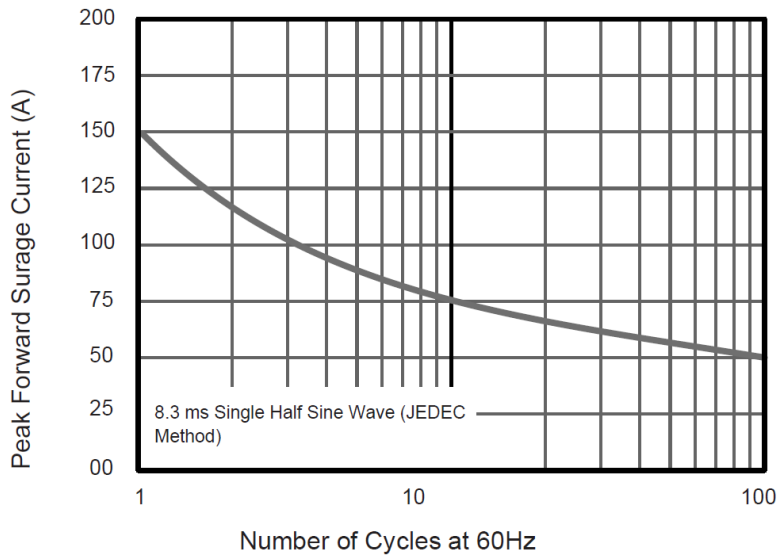

**Fig.6- Typical Transient Thermal Impedance**

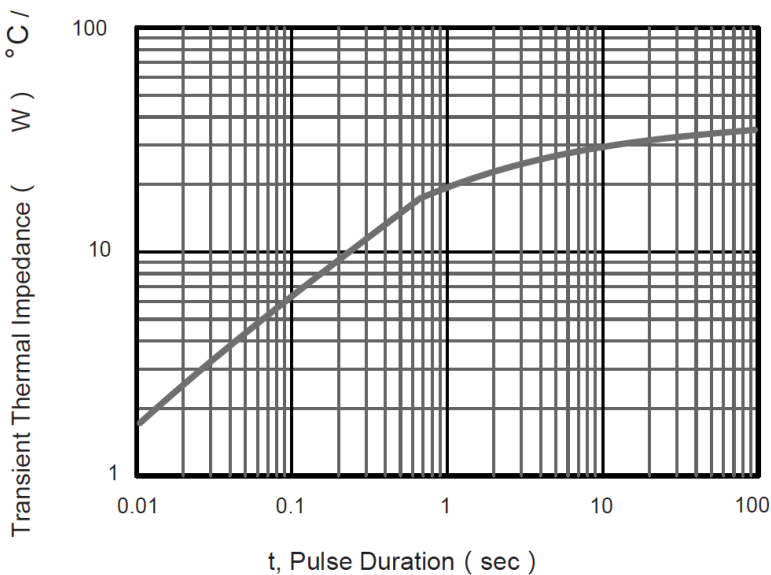

**SMD SCHOTTKY BARRIER RECTIFIER SMC SERIES**

**TAPE/REEL (Unit: mm)**

All Devices are packed in accordance with EIA standard RS-481-A and specifications.

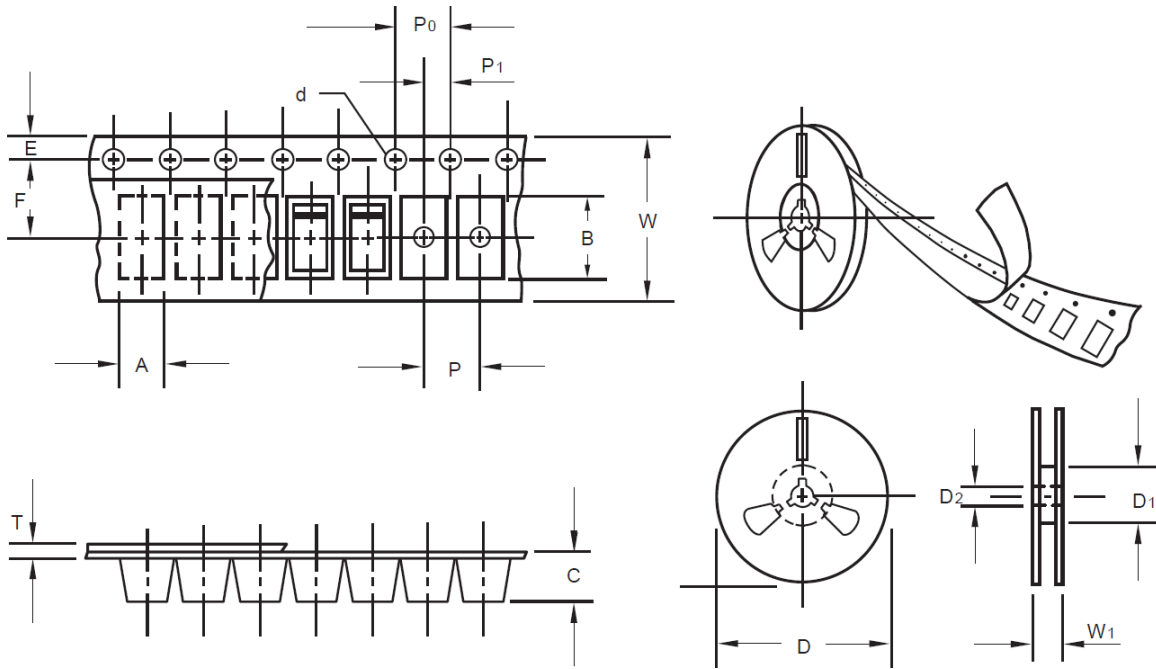

Item	Symbol	Tolerance	SMC/DO-214AB
Carrier width	A	0.1	6.15
Carrier Length	B	0.1	8.41
Carrier Depth	C	0.1	2.42
Sprocket hole	d	0.05	1.50
13" Reel outside diameter	D	2.0	330.00
13" Reel inner diameter	D1	Min.	50.00
7" Reel outside diameter	-	-	-
7" Reel inner diameter	-	-	-
Feed hole diameter	D2	0.5	13.00
Sprocket hole position	E	0.1	1.75
Punch hole position	F	0.1	7.50
Punch hole pitch	P	0.1	8.00
Sprocket hole pitch	P0	0.1	4.00
Embossment center	P1	0.1	2.00
Overall tape thickness	T	0.1	0.25
Tape width	W	0.3	16.00
Reel width	W1	1.0	16.50

**SMD SCHOTTKY BARRIER RECTIFIER SMC SERIES**

**PACKAGE For Reference**

<b>Case Code</b>	SMC
Reel Size	13"
Reel Size	330 mm
MPQ/Reel	3000 pcs
Qty. /Box	6000 pcs
G.W/Box	6 lbs

**DISCLAIMER**

NextGen Component, Inc. reserves the right to make changes to the product(s) and or information contained herein without notice. No liability is assumed as a result of their use or application. No rights under any patent accompany the sale of any such product(s) or information