

Style
M12 Socket, shielded
8 pin
A-coding

Ratings
Voltage: 30 V
Current: 2 A

Operating Temperature Range
-40~105 °C

Materials
① Insulator: Polyamide 66 (PA66), UL94 HB, black
② Pin: C5191 phosphor bronze, gold plated
③ Shell: C3604 brass, nickel plated
④ Nut: C3604 brass, nickel plated
⑤ O-ring: Nitrile rubber, green/black

Electrical Requirements
Dielectric strength: 1 min @ 500 Vac
Insulation resistance: 100 MΩ @ 500 Vdc
Contact resistance: 10 mΩ or less

Mechanical Requirements
Life cycle: 500 mating cycles minimum

Environmental Requirements
Salt spray test: 35 °C, relative humidity 90-95%, 5% NaCl mist for 48 hrs. Wash parts after test. Maintain mechanical requirements and a contact resistance of less than 10 mΩ.
Waterproof: IP67

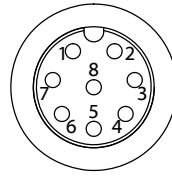

Front View
Not to Scale

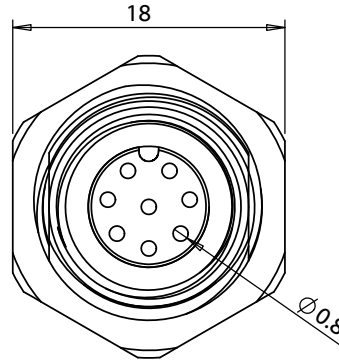

Panel cutout (PG9)
Panel thickness (4.5mm max.)

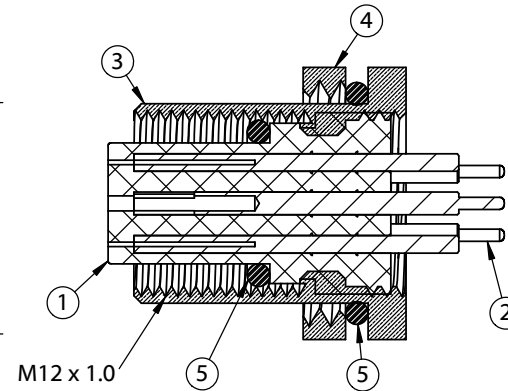
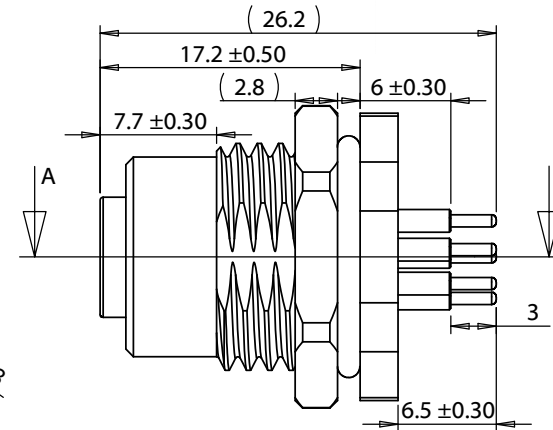
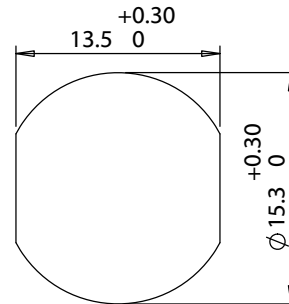

SECTION A-A

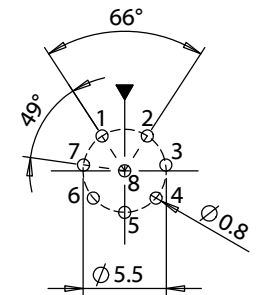
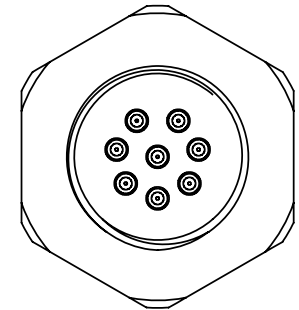
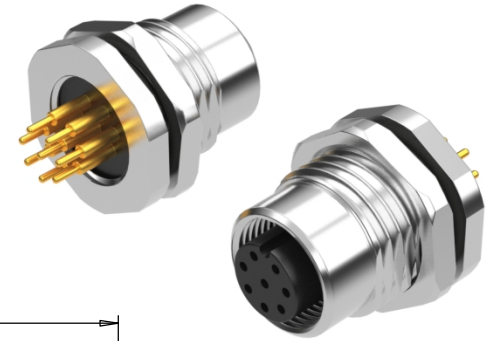

PCB Layout

Revision:	Date:	Description:
A	10/6/2020	Initial release

Prepared:	Notes:
	RoHS compliant
Verified:	Function test: no open, no short circuit, no intermittent
Dimensions are in millimeters. Tolerances: X: ± 0.3 mm X.X: ± 0.1 mm X.XX: ± 0.05 mm	Description: Connector, 8 pin M12 A-code socket, 12xL26.2mm, gold plated, panel mount, PCB, IP67

TENSILITY

tel 1.541.323.3228 800 877.670.7118
fax 1.541.323.4202 web tensility.com

Size:	Part number:
A	54-00238
Scale: 2:1	Sheet 1 of 1