

## N-Channel Enhancement Mode Power MOSFET

### Description

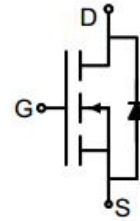
The GC041N65QF uses advanced trench technology to provide excellent  $R_{DS(ON)}$ , low gate charge. It can be used in a wide variety of applications.

### General Features

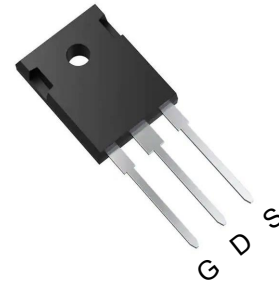
- $V_{DS}$  650V
- $I_D$  (at  $V_{GS} = 10V$ ) 70A
- $R_{DS(ON)}$  (at  $V_{GS} = 10V$ ) < 47m $\Omega$
- 100% Avalanche Tested
- RoHS Compliant
- Ultra-fast body diode

### Application

- Power switch
- DC/DC converters



Schematic diagram



TO-247

### Ordering Information

Device	Package	Marking	Packaging
GC041N65QF	TO-247	GC041N65F	30pcs/Tube

### Absolute Maximum Ratings $T_C = 25^\circ\text{C}$ , unless otherwise noted

Parameter	Symbol	Value	Unit
Drain-Source Voltage	$V_{DS}$	650	V
Continuous Drain Current	$I_D$	70	A
Pulsed Drain Current (note1)	$I_{DM}$	230	A
Gate-Source Voltage	$V_{GS}$	$\pm 30$	V
Power Dissipation	$P_D$	500	W
Single pulse avalanche energy (note2)	$E_{AS}$	4469	mJ
Operating Junction and Storage Temperature Range	$T_J, T_{stg}$	-55 To 150	$^\circ\text{C}$

### Thermal Resistance

Parameter	Symbol	Value	Unit
Thermal Resistance, Junction-to-Ambient	$R_{thJA}$	40	$^\circ\text{C/W}$
Maximum Junction-to-Case	$R_{thJC}$	0.25	$^\circ\text{C/W}$

Specifications $T_J = 25^\circ\text{C}$ , unless otherwise noted						
Parameter	Symbol	Test Conditions	Value			Unit
			Min.	Typ.	Max.	
<b>Static Parameters</b>						
Drain-Source Breakdown Voltage	$V_{(BR)DSS}$	$V_{GS} = 0V, I_D = 250\mu A$	650	--	--	V
Zero Gate Voltage Drain Current	$I_{DSS}$	$V_{DS} = 650V, V_{GS} = 0V$	--	--	10	$\mu A$
Gate-Source Leakage	$I_{GSS}$	$V_{GS} = \pm 30V$	--	--	$\pm 100$	nA
Gate-Source Threshold Voltage	$V_{GS(th)}$	$V_{DS} = V_{GS}, I_D = 250\mu A$	3.0	3.9	5.0	V
Drain-Source On-Resistance	$R_{DS(on)}$	$V_{GS} = 10V, I_D = 38A$	--	37	47	m $\Omega$
Forward Transconductance	$g_{FS}$	$V_{GS} = 20V, I_D = 38A$	--	43	--	S
<b>Dynamic Parameters</b>						
Input Capacitance	$C_{iss}$	$V_{GS} = 0V,$ $V_{DS} = 380V,$ $f = 1.0\text{MHz}$	--	7794	--	pF
Output Capacitance	$C_{oss}$		--	206	--	
Reverse Transfer Capacitance	$C_{rss}$		--	172	--	
Total Gate Charge	$Q_g$	$V_{DD} = 380V,$ $I_D = 38A,$ $V_{GS} = 10V$	--	160	--	nC
Gate-Source Charge	$Q_{gs}$		--	35	--	
Gate-Drain Charge	$Q_{gd}$		--	55	--	
Turn-on Delay Time	$t_{d(on)}$	$V_{DD} = 380V,$ $I_D = 38A,$ $R_G = 4.7\Omega$	--	55	--	ns
Turn-on Rise Time	$t_r$		--	65	--	
Turn-off Delay Time	$t_{d(off)}$		--	175	--	
Turn-off Fall Time	$t_f$		--	48	--	
<b>Drain-Source Body Diode Characteristics</b>						
Continuous Body Diode Current	$I_S$	$T_C = 25^\circ\text{C}$	--	--	70	A
Body Diode Voltage	$V_{SD}$	$T_J = 25^\circ\text{C}, I_{SD} = 70A, V_{GS} = 0V$	--	--	1.2	V
Reverse Recovery Charge	$Q_{rr}$	$I_F = 26A, V_{GS} = 0V$ $di/dt = 100A/\mu s$	--	1.5	--	nC
Reverse Recovery Time	$T_{rr}$		--	207	--	ns

### Notes

1. Repetitive Rating: Pulse width limited by maximum junction temperature
2. EAS condition :  $T_J = 25^\circ\text{C}, V_{DD} = 50V, V_{GS} = 10V, L = 0.5\text{mH}, R_G = 25\Omega$
3. Identical low side and high side switch with identical  $R_G$

### Gate Charge Test Circuit



### Switch Time Test Circuit

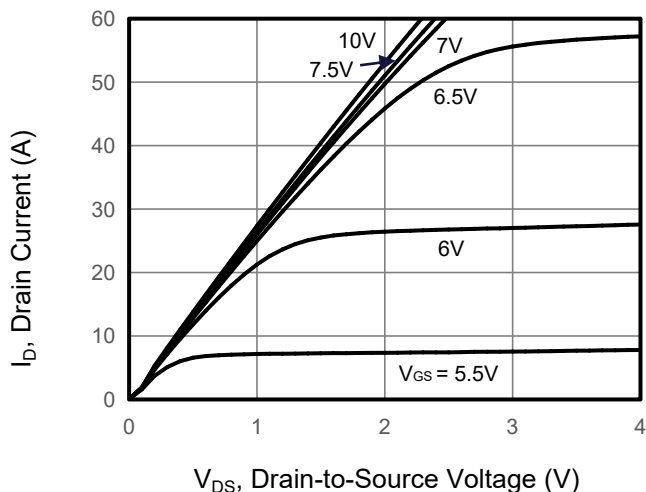


### EAS Test Circuit

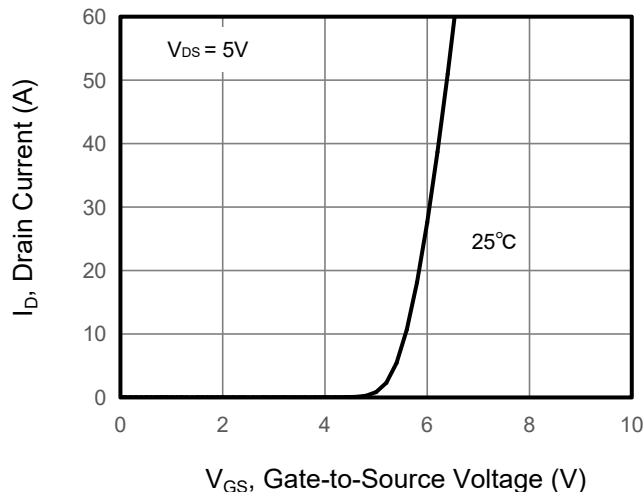


Typical Characteristics  $T_J = 25^\circ\text{C}$ , unless otherwise noted

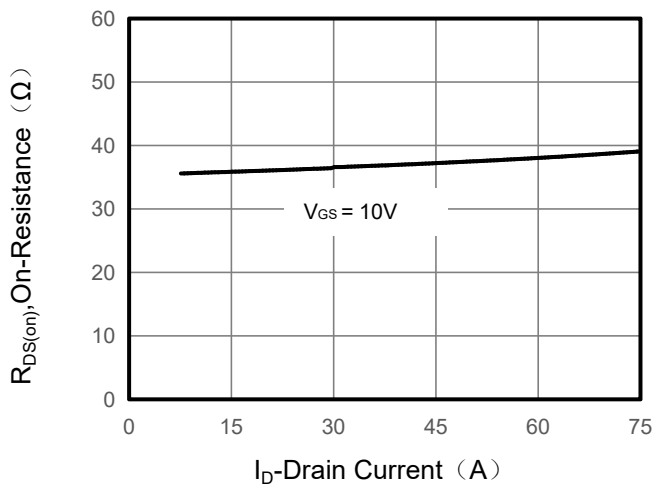
**Figure 1. Output Characteristics**



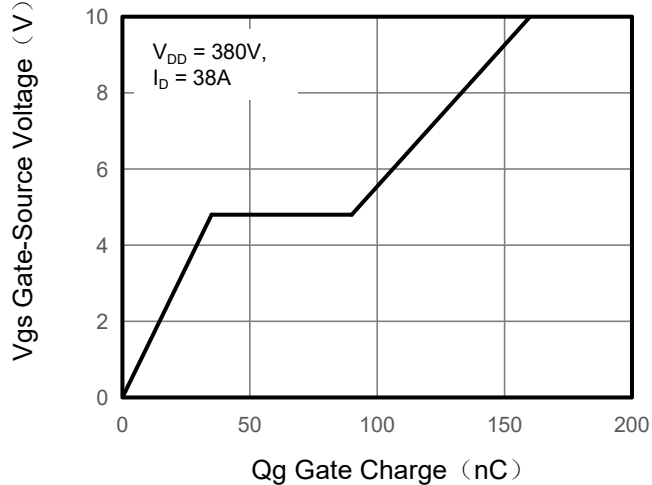
**Figure 2. Transfer Characteristics**



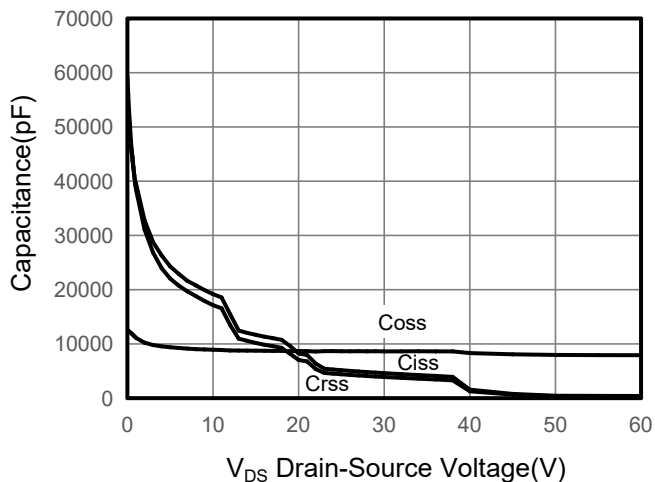
**Figure 3. Drain Source On Resistance**



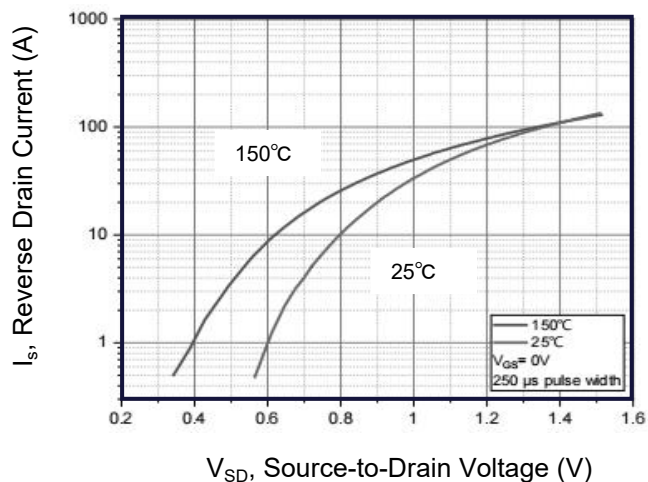
**Figure 4. Gate Charge**



**Figure 5. Capacitance**

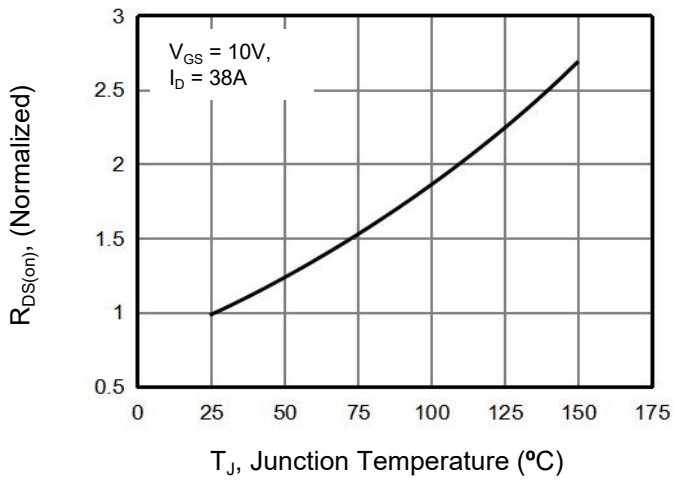


**Figure 6. Source-Drain Diode Forward**

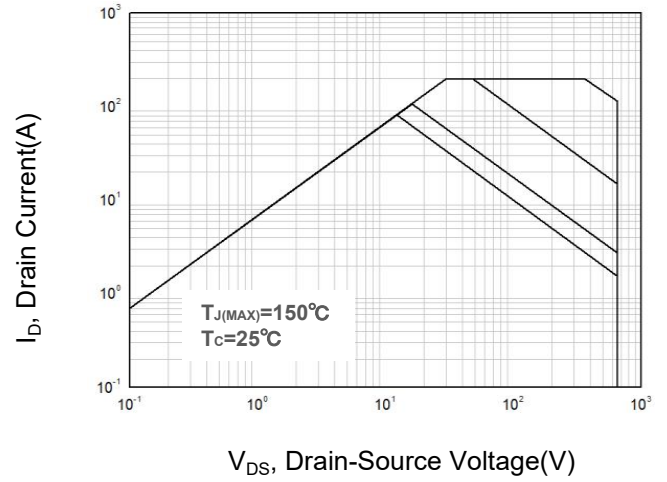


## Typical Characteristics $T_J = 25^\circ\text{C}$ , unless otherwise noted

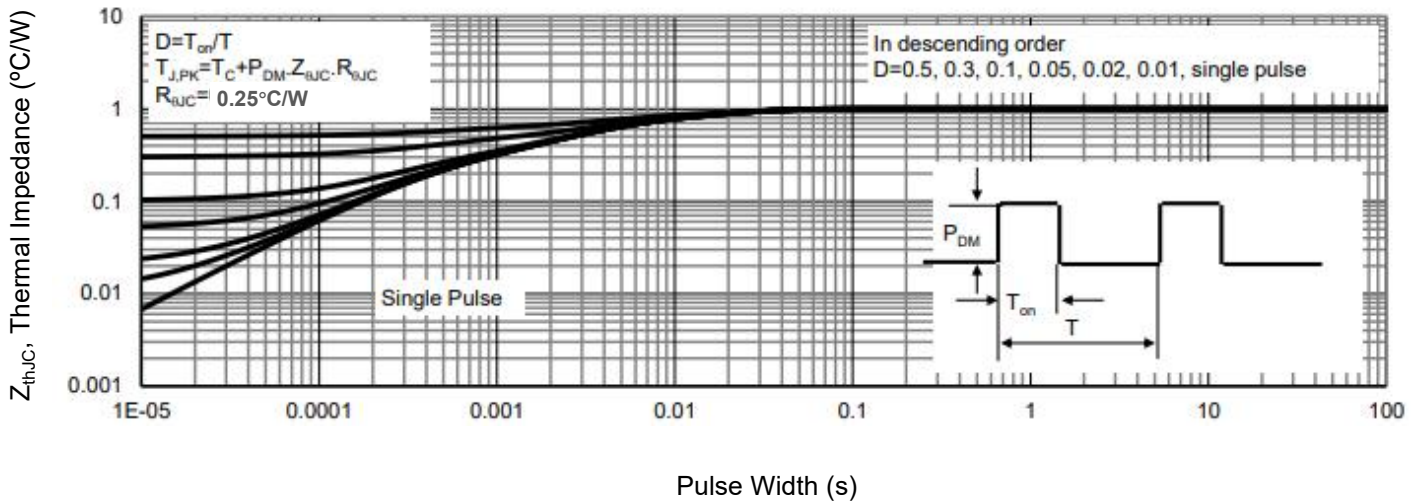
**Figure 7. Drain-Source On-Resistance**



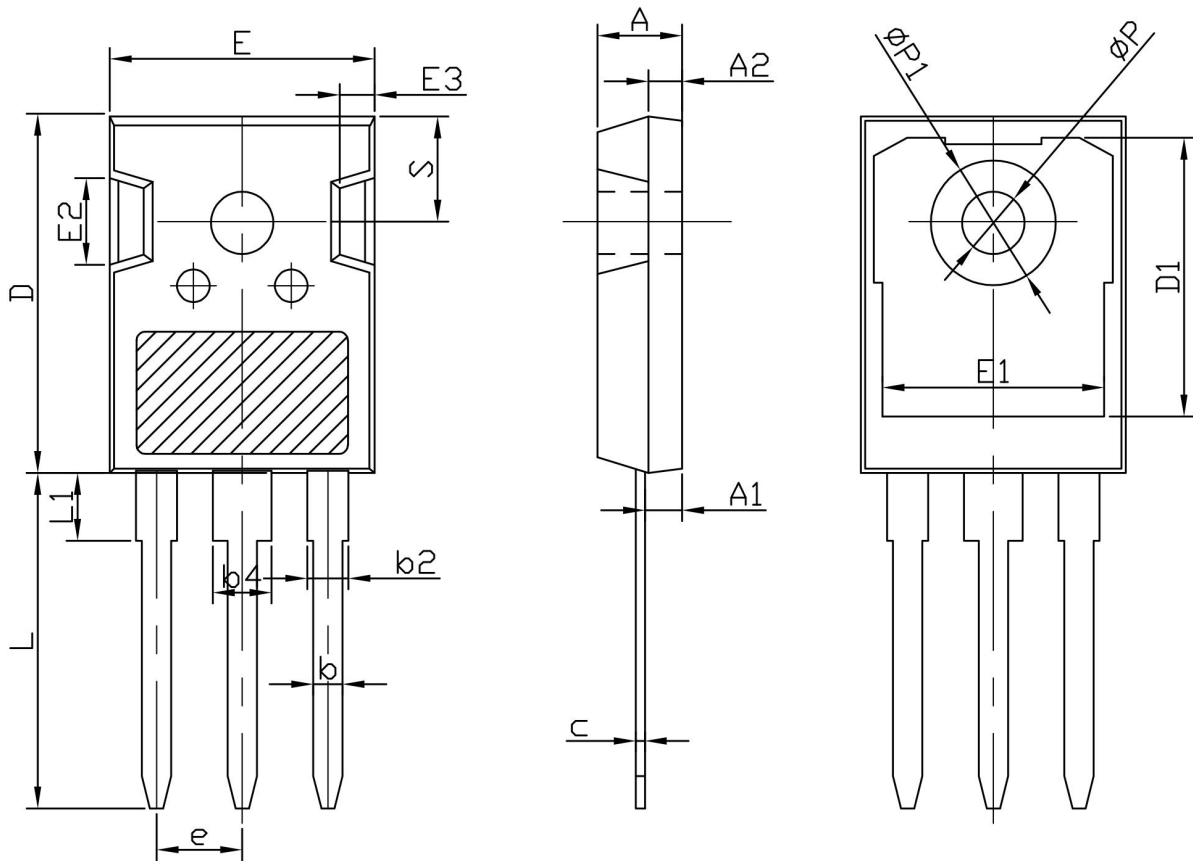
**Figure 8. Safe Operation Area**



**Figure 9. Normalized Maximum Transient Thermal Impedance**



## TO-247 Package Information



SYMBOL	mm		
	MIN	NOM	MAX
A	4.80	5.00	5.20
A1	2.21	2.41	2.59
A2	1.85	2.00	2.15
b	1.11	1.21	1.36
b2	1.91	2.01	2.21
b4	2.91	3.01	3.21
c	0.51	0.61	0.75
D	20.70	21.00	21.30
D1	16.25	16.55	16.85
E	15.50	15.80	16.10
E1	13.00	13.30	13.60
E2	4.80	5.00	5.20
E3	2.30	2.50	2.70
e	5.44BSC		
L	19.62	19.92	20.22
L1	-	-	4.30
ØP	3.40	3.60	3.80
ØP1	-	-	7.30
S	6.15BSC		